

Table of Contents

Chapter 1: Introduction 2

 1.1 Mainboard Features ----- 3

Chapter 2: Hardware Installation----- 5

 2.1 Mainboard Layout and Connectors Jumpers View---- 5

 2.2 Connectors and Jumpers Setting----- 6

 2.3 INSTALL CPU ----- 17

 2.4 VT82C693A+VT82C596B APOLLO PRO-133----- 24

 2.5 Install Memory ----- 25

2.6 Genesys Logic system Monitor----- 26

Chapter

3: BIOS SETUP ----- 29

 3.1 Main Menu ----- 30

 3.2 Standard CMOS Setup ----- 32

 3.3 BIOS Features Setup ----- 36

 3.4 Supervisor/User Password Setting ----- 41

 3.5 Setup/Integrated Peripherals Features Setup ----- 42

 3.6 Setup Power Management ----- 49

 3.7 Setup PnP/PCI Configuration ----- 54

The mainboard is a high-performance personal computer mainboard based on the ZIF Socket 370 processor.

The mainboard uses the highly integrated Intel 82440BX/ZX OR VIA APOLLO PRO AGPset which optimize the system bandwidth and concurrency with the implementation of Quad port Acceleration (QPA). QPA provides 4-port concurrent arbitration of the processor bus, graphics, PCI bus and SDRAM.

The Intel 82371AB OR VIA VT82C596 chipset integrates all system control functions such as ACPI (Advanced Configuration and Power Interface). The ACPI provides more Energy Saving Features for the OSPM (OS Direct Power Management) function. The Intel 82371AB OR VIA VT82C596 chipset also improves the IDE transfer rate by supporting Ultra DMA/33 IDE that transfers data at the rate of 33MB/s.

NEW:

VT82C693A+VT82C596B APOLLO PRO-133

- ★ VT82C693A SUPPORT 133MHZ DRAM BUS AND 256MB SDRAM.
- ★ VT82C596B SUPPORT ULTRA DMA/66 FUNCTION.

1.1 Mainboard Features

CPU

- Slot 1 for ZIF Socket 370 processor.
- Supports 300MHZ - 550MHZ and higher.
- Core/Bus ratios are x2, x2.5, x3, x3.5, x4, x4.5, x5, x5.5, x6 and higher.

Clock Generator

- 66MHZ~150MHZ BUS CLOCK SELECT.
- AUTO detect CPU BUS CLK frequency. For 66 OR 100MHZ

Switching Voltage Regulator

- On-board switching mode DC-DC Step Down Regulator.

Chip Set

- Mainboard: Intel 82440BX/82440ZX/VIA APOLLO PRO PCI Chipset.
- Enhanced I/O : Winbond 83977 Chipset.
- Via 693A support 133 MHZ DRAM bus and 256MB SDRAM.

System Memory, DIMM*2

- Supports two 168-pin unbuffered DIMM Socket.
- Supports memory size up to 256 MB.(Via 693A memory size up to 1GB.)
- Supports 3.3v Extended Data Output (EDO) and SDRAM DIMM.

Expansion Slots, AGP1, PCI1-PCI4, ISA1

- One AGP(Accelerated Graphics port) slot.- AGP specification compliant.
- Four 32-bit Master PCI Bus slots and One 16-bit ISA bus slots wherein one shared slot that can be used as ISA or PCI.

ACPI (ATX Power Supply Mode)

- power management. Soft-off Control.
- Supports Modem Ring-in.
- Supports RTC Alarm wake up.
- Supports WOL (Wake on Lan).
- Supports Keyboard and Mouse Wake up.

Enhance PCI IDE & I/O Interface

- Supports two PCI Bus, Master IDE ports (up to 4 IDE devices).
- Supports Ultra DMA/33 function.(596B support ultra DMA/66 function.)
- Supports SCSI/CD-ROM function.
- 1. floppy port supports 2FDD with 360k, 720k, 1.2M, 1.44M and 2.88M bytes.
- 2. serial ports (COM1+COM2 Two 16550 high speed UART ports).
- 1. parallel port supports SPP/EPP/ECP mode.
- USB connector
- 1. IrDA TX/RX Header.
- PS/2 mouse interface.
- AT Keyboard

System Green BIOS

- Flash BIOS option on board, AWARD deep green BIOS, PLUG & PLAY, PnP function.
- Auto configuration for PCI add-on cards.
- I/O Device's power saving, APM & SMI.
- Implements the EPA Energy Star PC specification with Deep Green system design.

Full-on : System runs in full speed CPU clock.

Doze : System scales-down CPU clock.

Standby : System scales-down the CPU clock, and turns off video display, and spin-off hard disk driver.

Suspend: With SMM CPU, stop CPU clock in suspend mode.

Power Connect

- ATX ,AT Power Supply.

PCB Dimension

- AT Form Factor :22cmx22cm x 4 layers PCB.

2.1 Mainboard Layout And Connectors Jumpers View

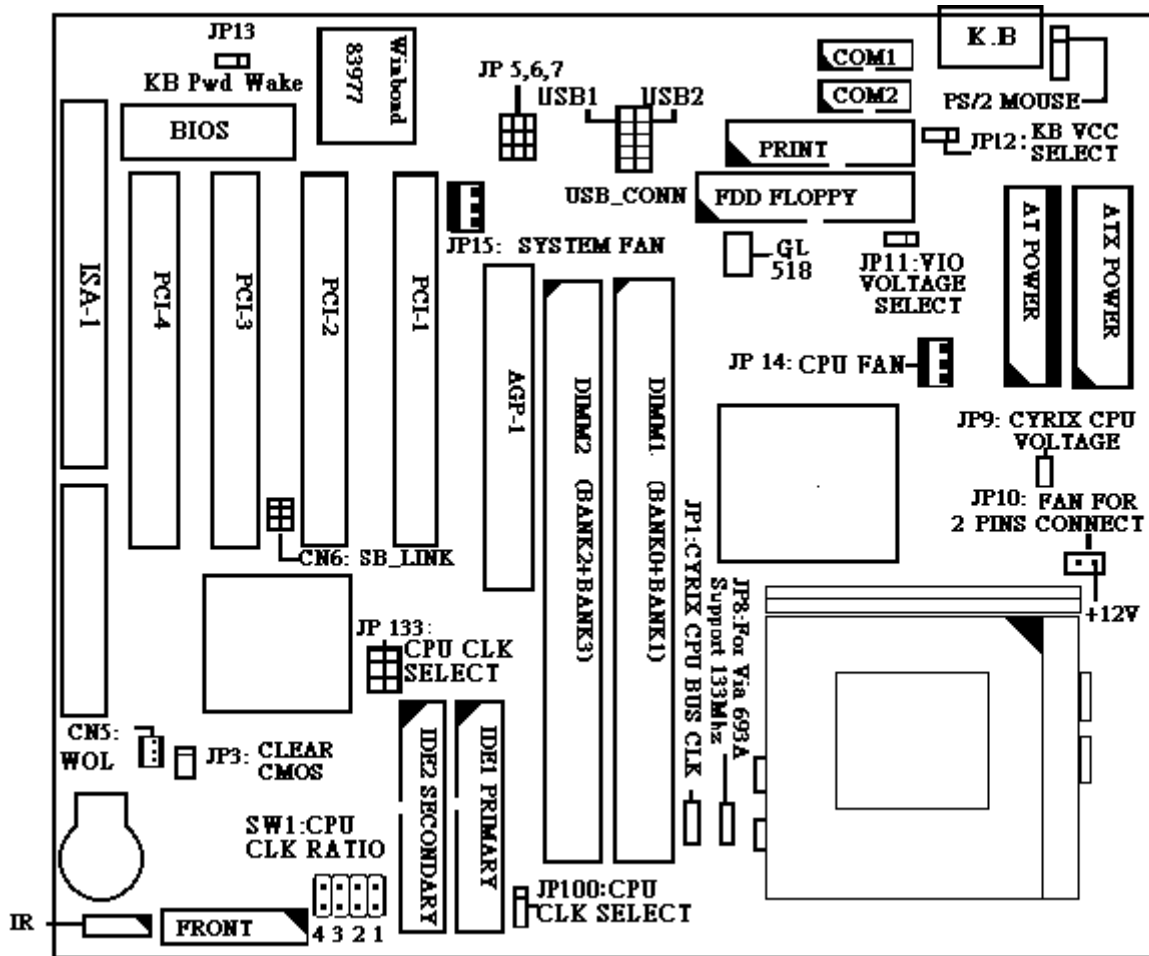

2-2 Connectors & Jumper Setting

FRONT1: Power LED, Speaker, ATX Power Stand By LED, ATX Power Switch, Reset, Hard disk LED, Turbo LED, Turbo Switch.

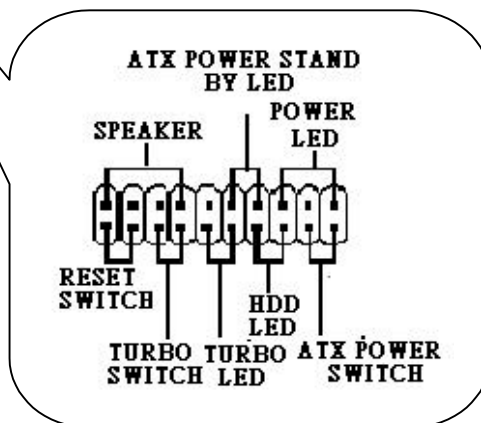
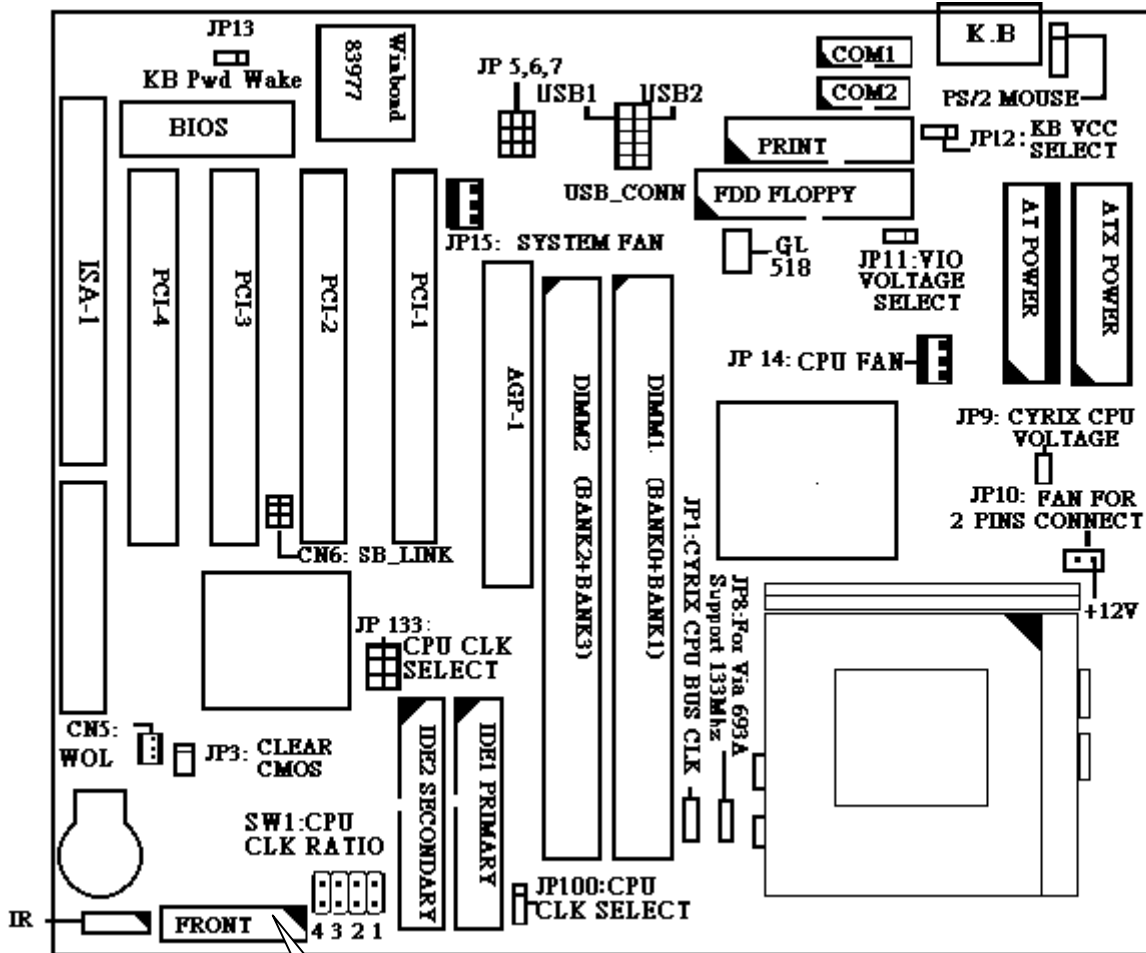

PS: ATX POWER SWITCH

1.For Bios Setup Power Management Setup,In One Of The Item "SOFT-OFF BY PWR-BTTN:DELAY 4 SEC "

In this mode,When You One Touch (1 SEC.) will be into the suspend mode,and press Any key will recover it. If you are keeping touch 4 sec above,the ATX power will be off.

2.If you shut down the computer the ATX POWER STAND BY LED will light.

MOUSE 1: PS/2 Mouse Connector & KB.CONN .Keyboard Connector
CN7,8 : Serial Port 1 Connector , Serial Port2 Connector ,
CN4: Printer Port Connector

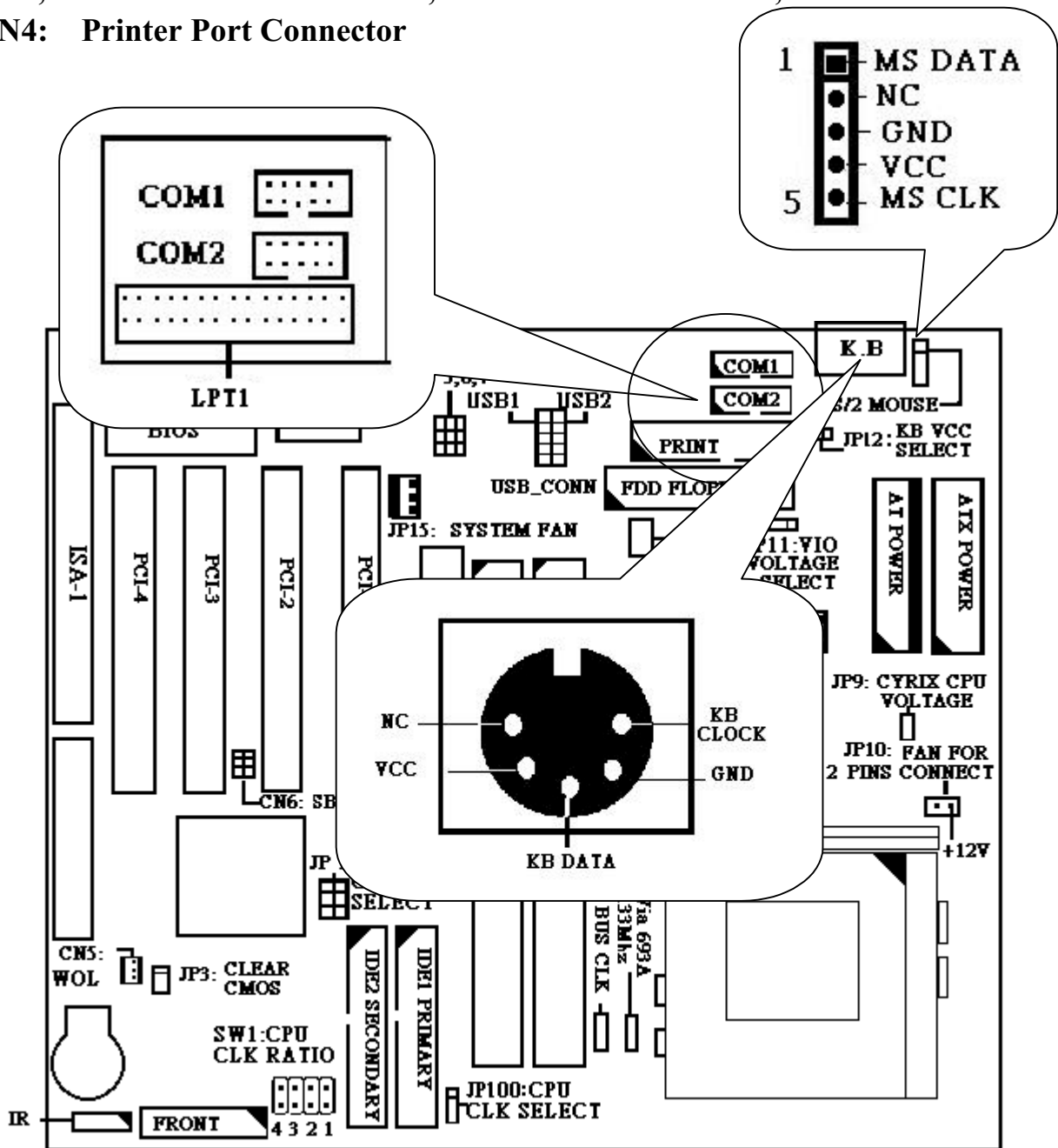

ATX POWER SUPPLY CONNECTOR

AT POWER SUPPLY CONNECTOR

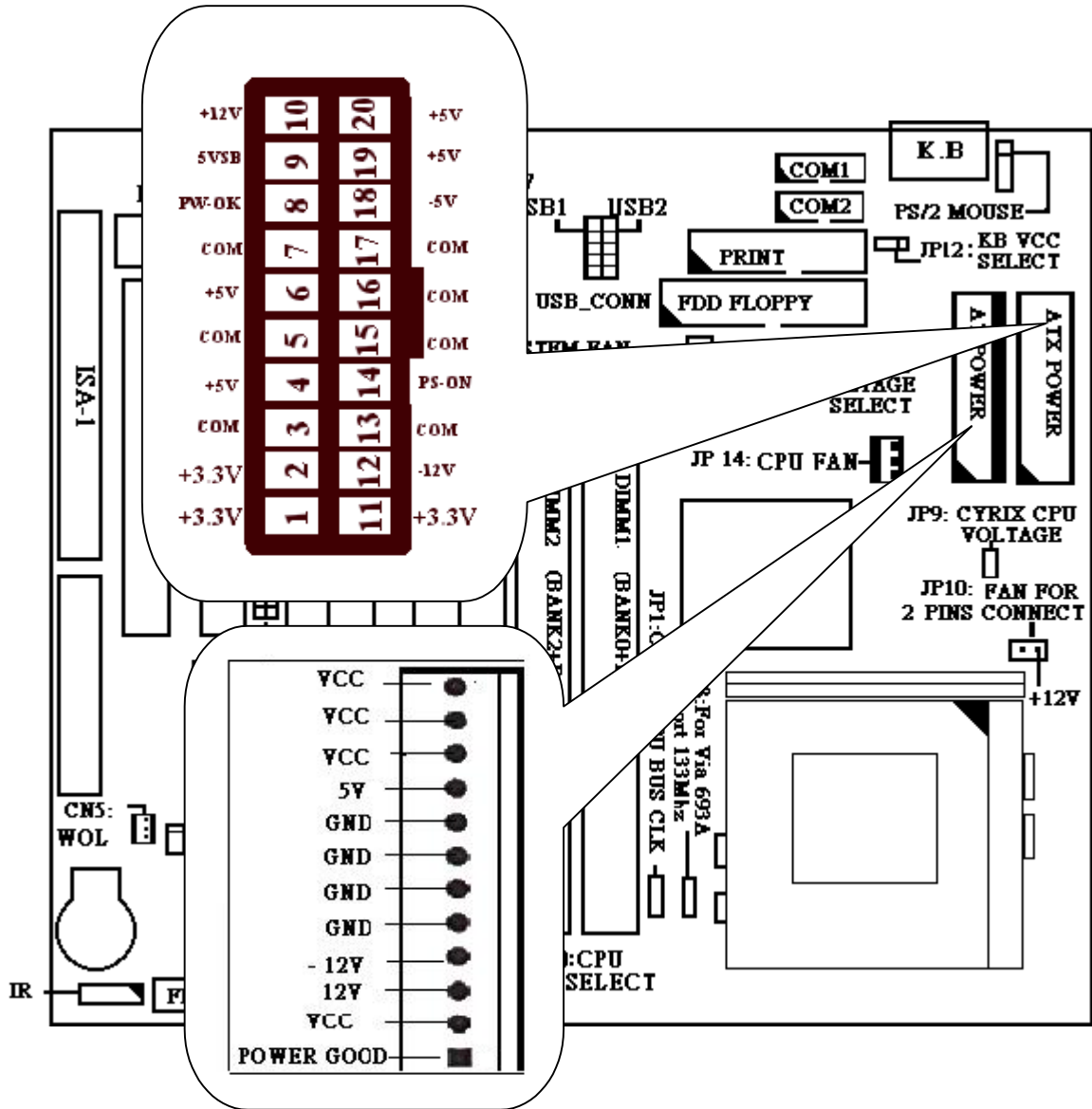

IR FIR/CIR (Infrared Rays)CONNECT.

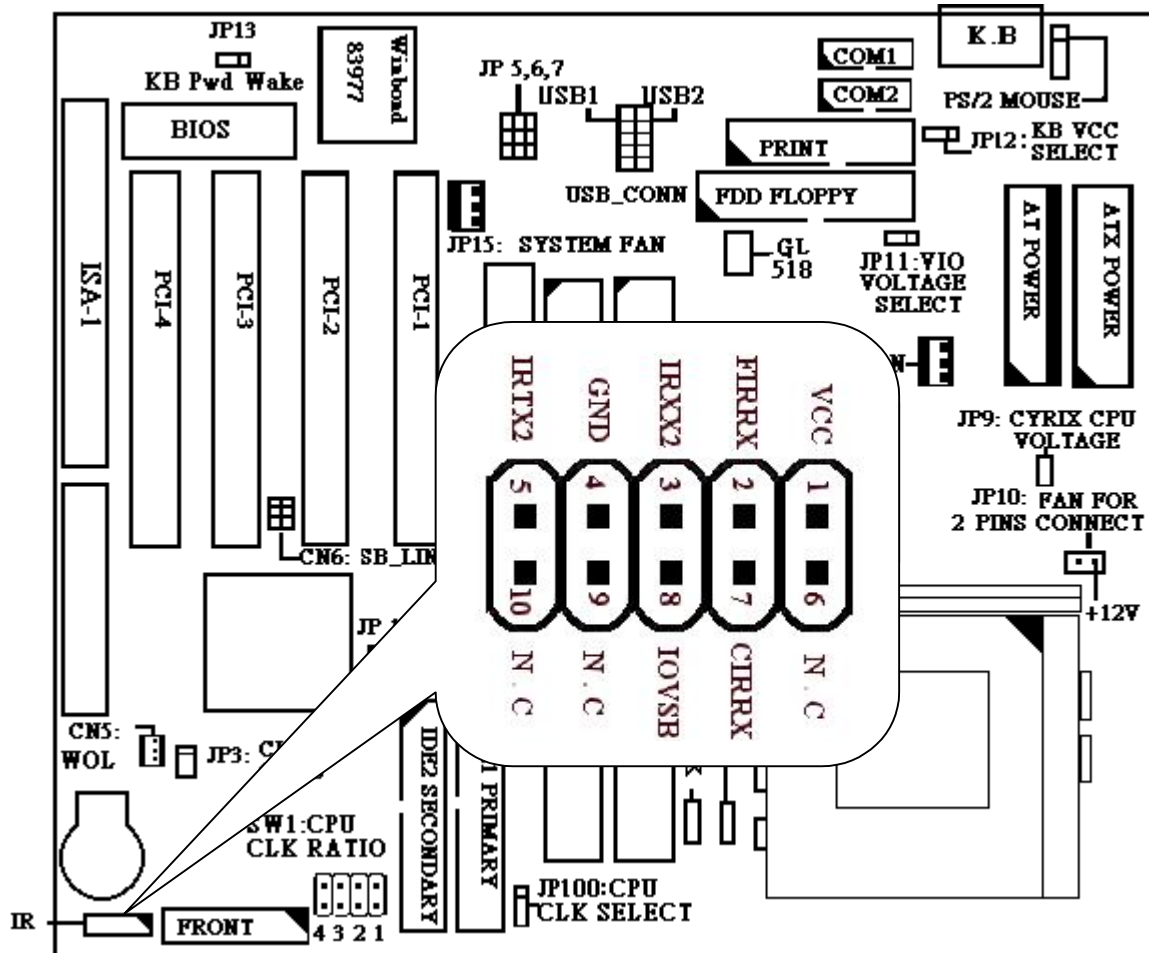

- SIR(STANDARD IR) for IR pin out (1-5) user winbond I/O W83977TF-AW (DEFAULT)
- FIR (FAST IR)for IR pin out (1-5) user winbond I/O W 83977ATF-AW
- CIR(CONSUMER IR) for IR pin out (1-10) user Winbond I/O W83977CTF

CN5 : WOL (WAKE ON LAN) CONNECT

*For supporting this feature, the system must have
Atx power supply supported
,that must provide at least 800mA driving ability on the
"5V standby" voltage*

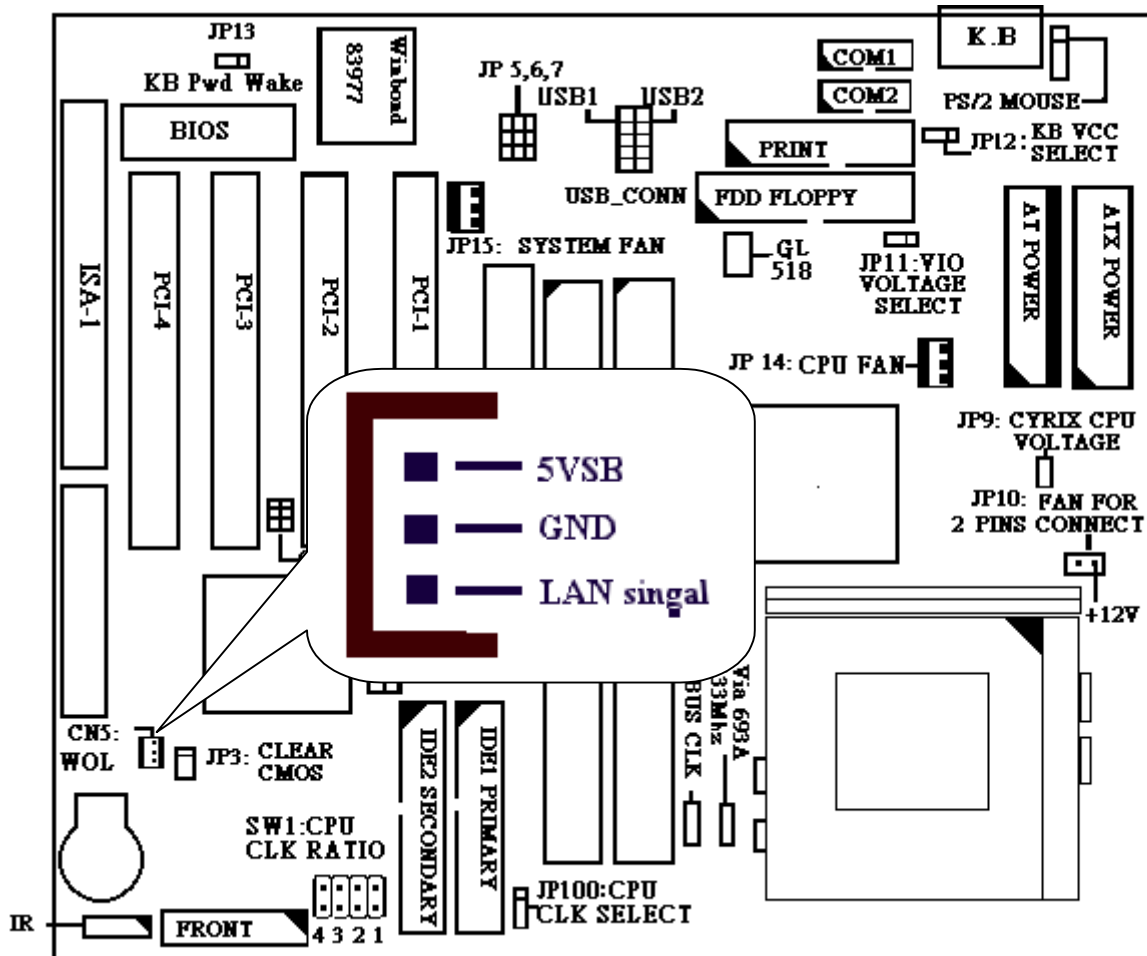

CN6 : SB_LINK Connect (for PCI BUS Sound Cards . Sush As Creative Labs EMU 8088 Sound CHIP)

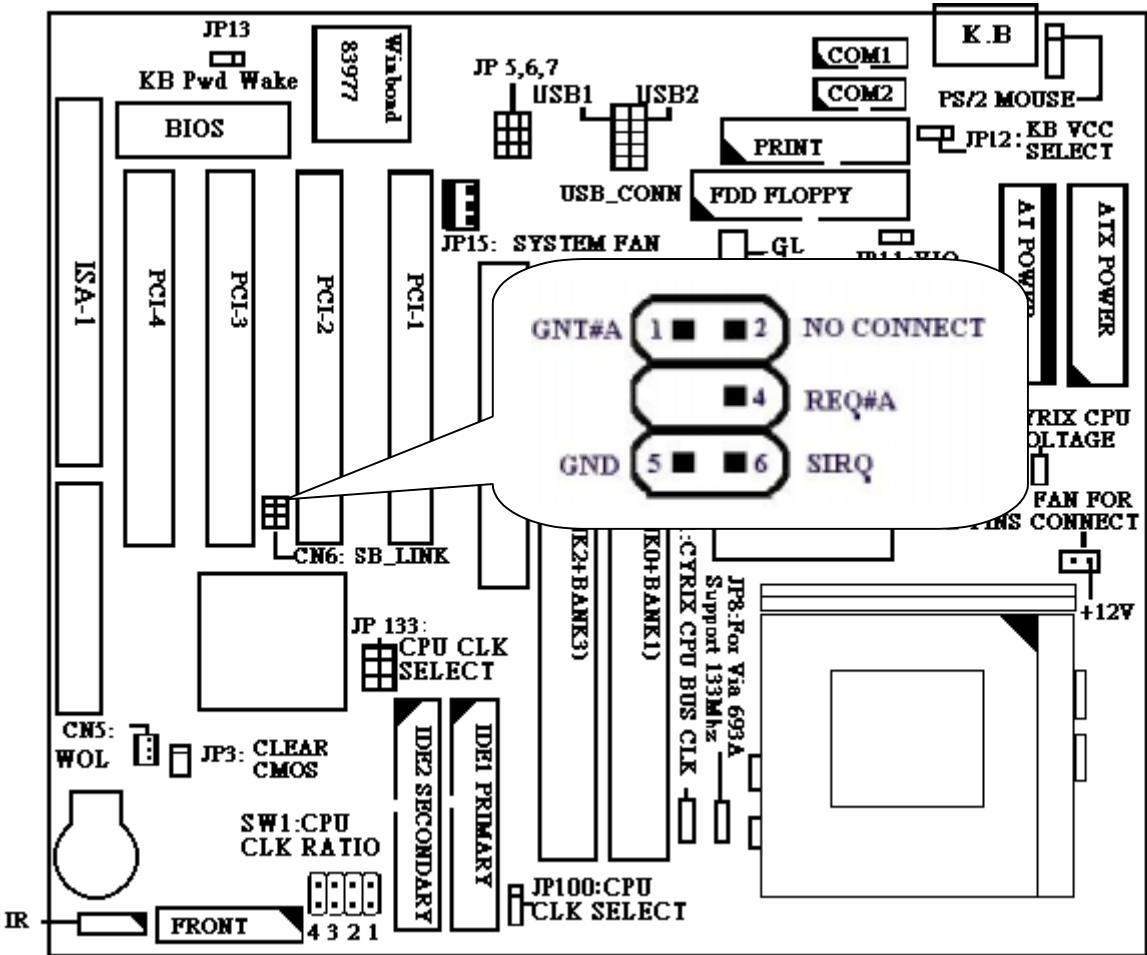

JP14: CPU FAN CONNECT

Warning:

If the temperature is below 20°C CPUFAN2 (JP14) will not work.
The temperature above 27°C CPUFAN2(JP14) will start to work.
But SYSTEM FAN (JP15) is always work . not limit for temperature.

JP15 : SYSTEM FAN CONNECT(Fan always work)

JP10: NORMAL 2 PINS FAN CONNECT(Fan always work)

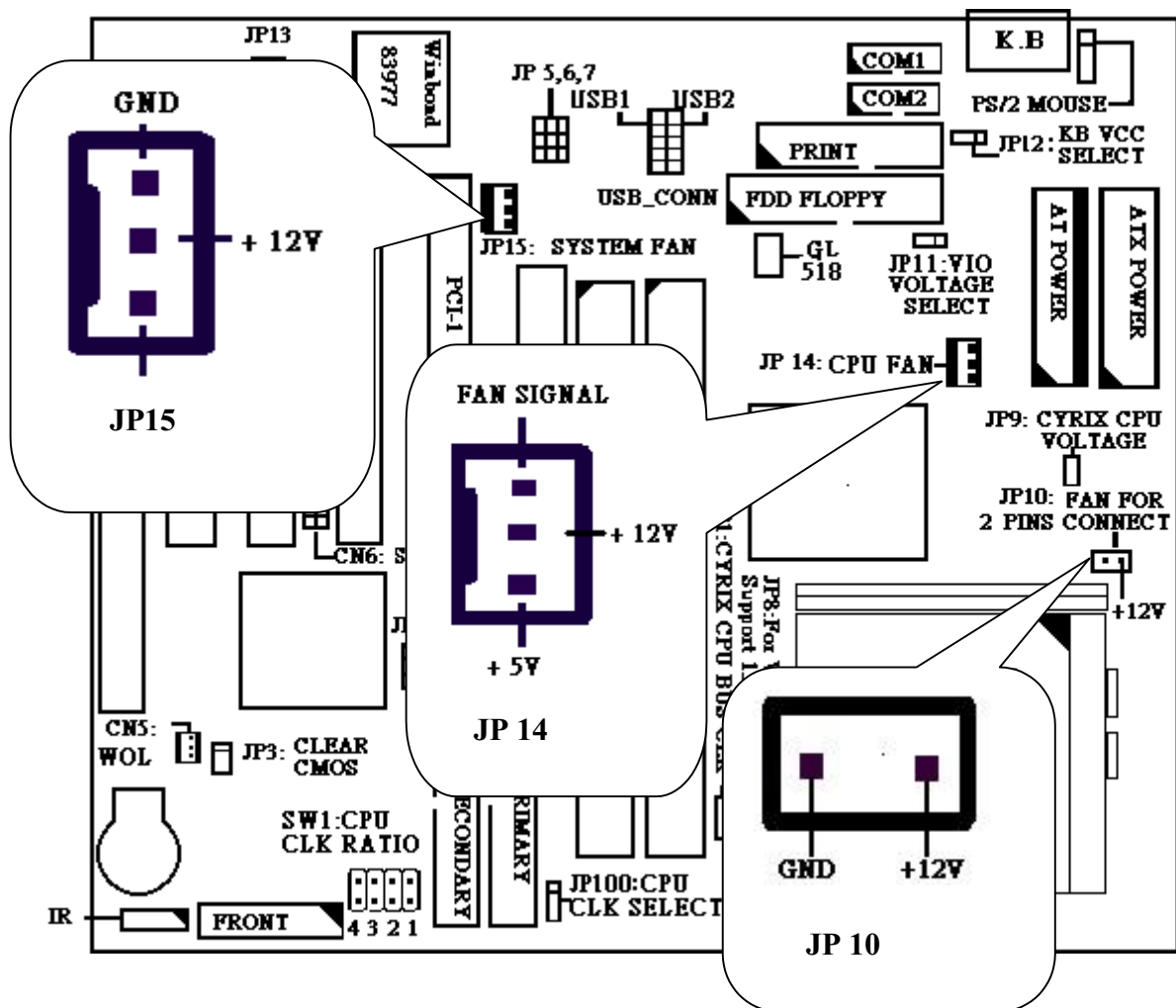

JP 5.6.7 : USB AND AGP USB MODE

JP3 : CMOS CLEAR SELECT

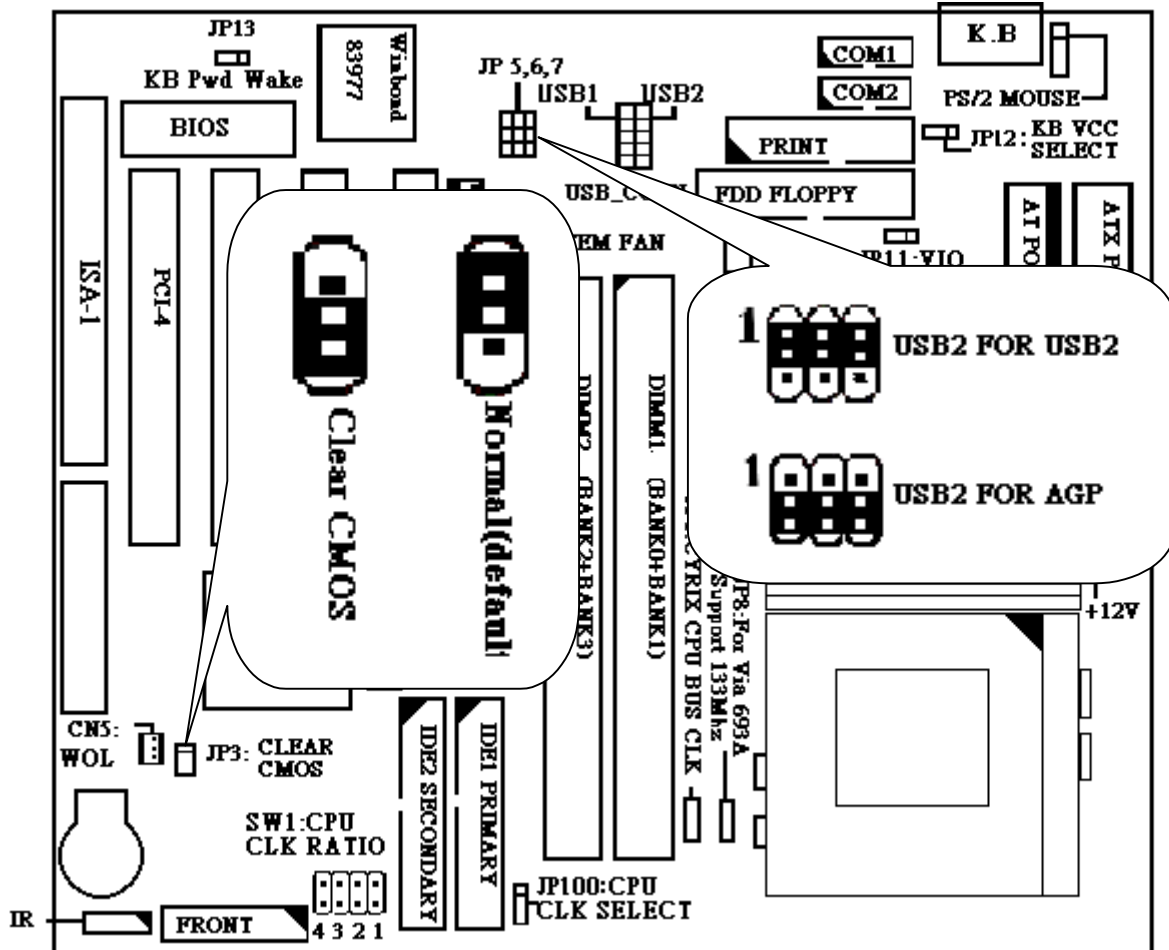

P.S *INTEL Chipset Only Support Two USB PORT(USB1,USB2)
But if some AGP card design USB ,You can change the
Jumper from USB to AGP, It mean that disable the system USB2 port,
then you Can use the AGP USB port.*

Warning:

*Clear CMOS: When you clear CMOS,you got to power off(AC&DC)
your computer,
And clear CMOS about 5~10 secs,and you should change
Back your jumper to normal (default),*

JP12: KEYBOARD VCC SELECTOR

JP 13 : KEYBOARD PASSWORD HARDWARE CONTROL SELECTOR

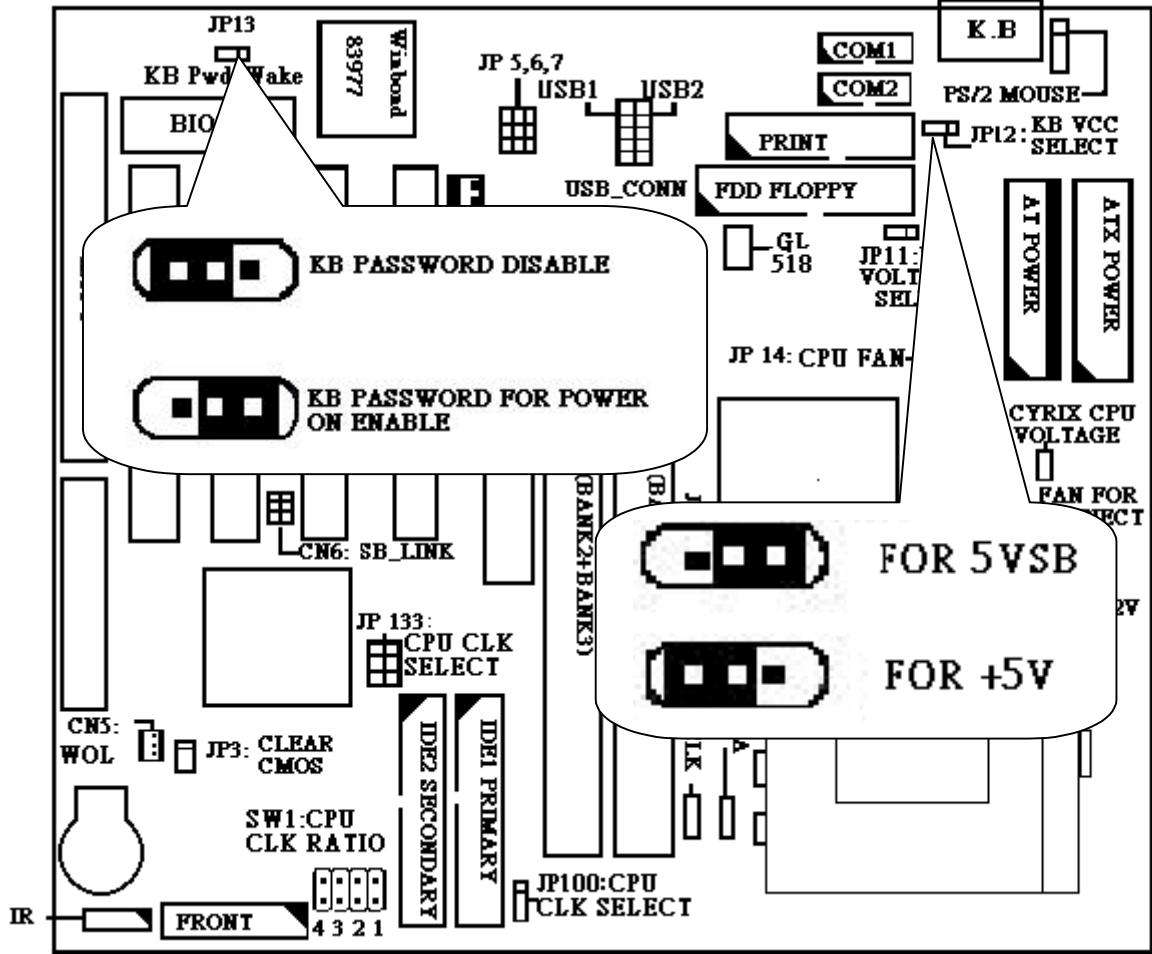

P.S. On the ATX power mode, some keyboard or mouse have large circuit loading, so you can change this jumper from +5VSB to +5V, then your system will be more stable, but when you change this jumper to +5V, it will not support the keyboard and mouse wake function..

USB_CONN(Universal Serial Bus port) Connector

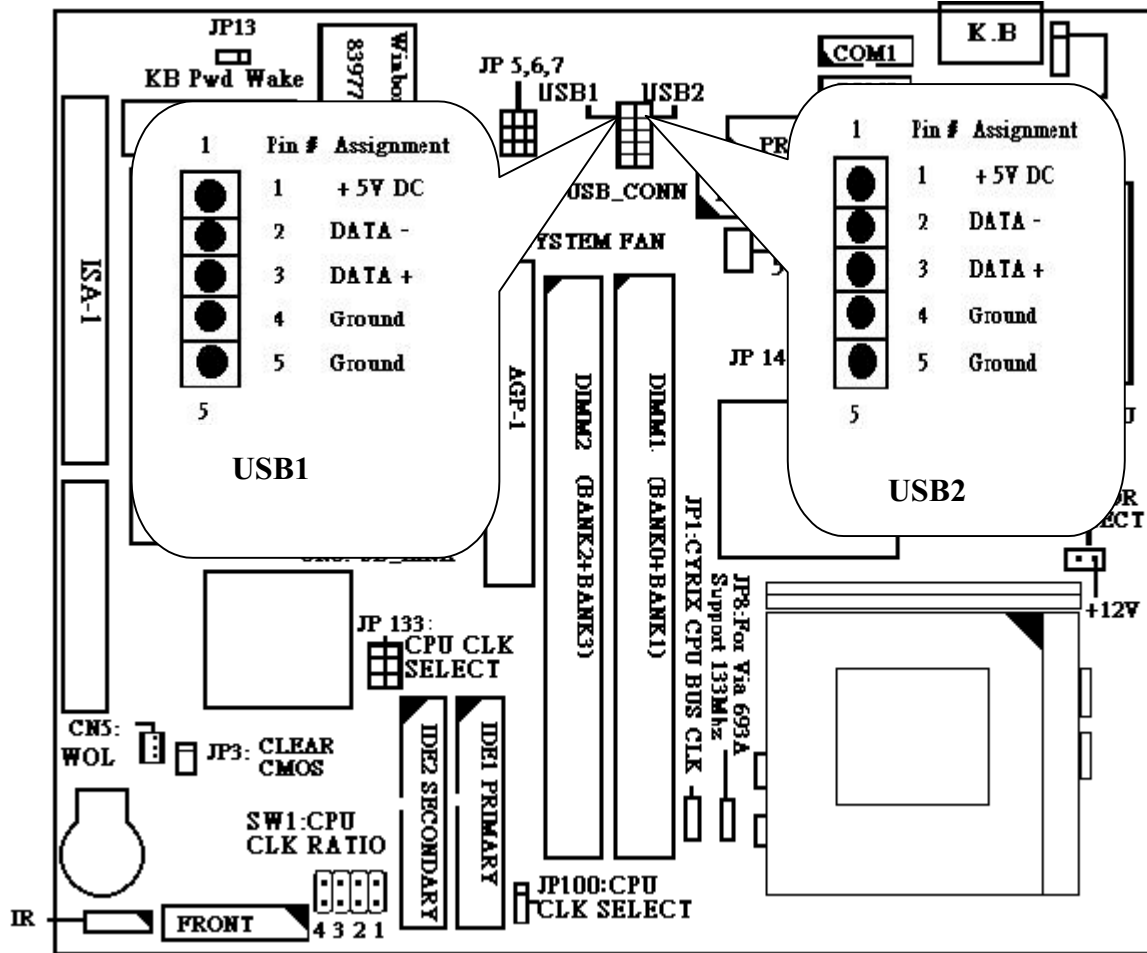

JP 11: VIO Voltage Select

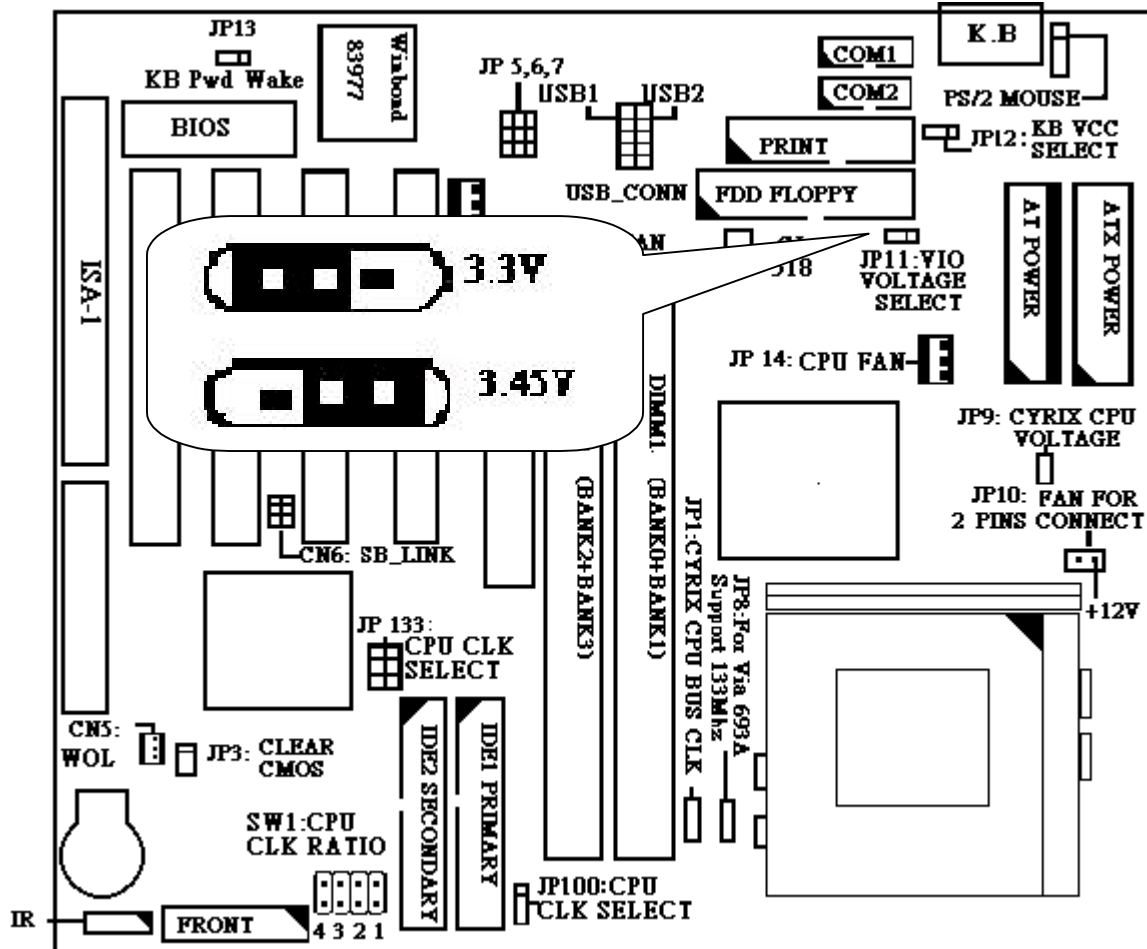

PS . *When some Agp Card have large circuit loading or power Supply voltage is not stable,you can try and change the Jumper from 3.3V to 3.45V. it will make your system More stabler.and have good condition.*

2-3 INSTALL CPU

(1) INTEL ZIF Socket 370 CPU RATIO Jumper Setting :
(SW1)

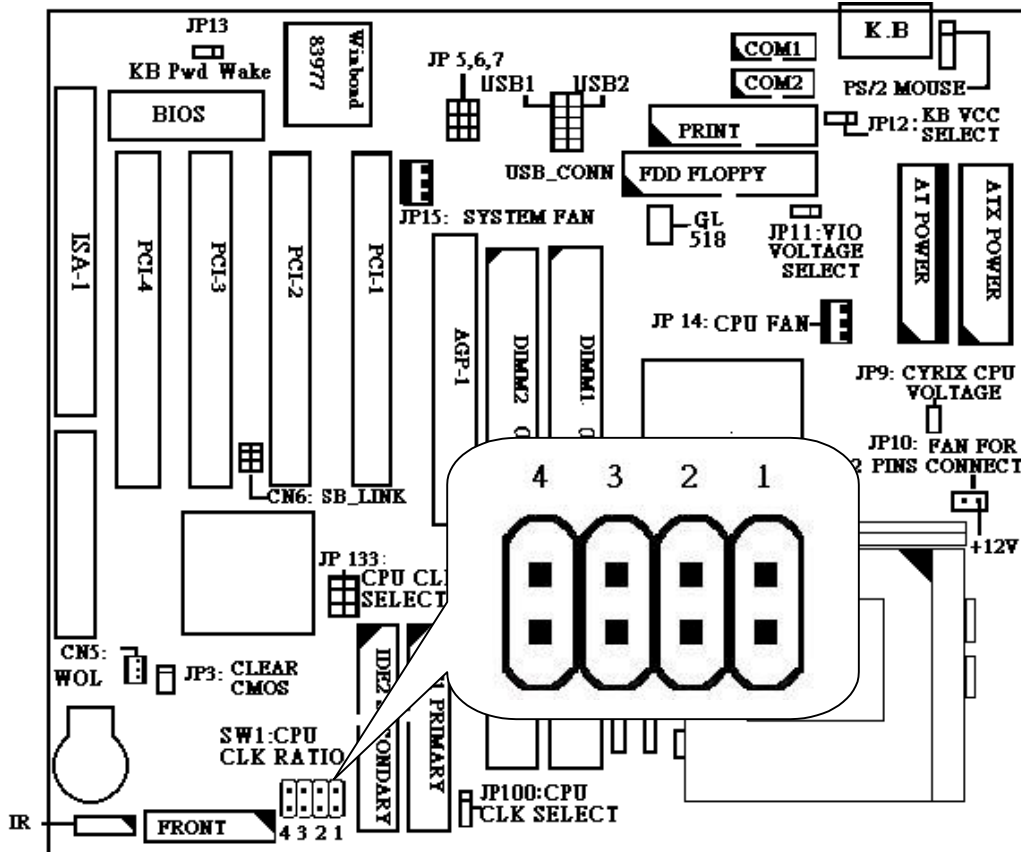

SW 1 :CPU RATIO SELECTOR

CPU RATIO	SW 1				CPU RATIO	SW 1				CPU RATIO	SW 1								
	4	3	2	1		4	3	2	1		4	3	2	1					
2X	●	●	●	●	4X	●	●	●	○	6X	●	●	●	●	8X	●	●	●	○
2.5X	○	●	●	●	4.5X	○	●	●	●	6.5X	○	●	●	●	8.5X	○	●	●	○
3X	●	○	●	●	5X	●	○	●	●	7X	○	○	●	●	9X	●	○	○	○
3.5X	○	○	●	●	5.5X	○	○	○	●	7.5X	○	○	○	●	9.5X	○	○	○	○

CLOSE JUMPER ↑
 ON OFF ↑↑
 ↓
 OPEN JUMPER

(2) CPU CLK SETTING FOR AUTO DETECT AND MANUAL

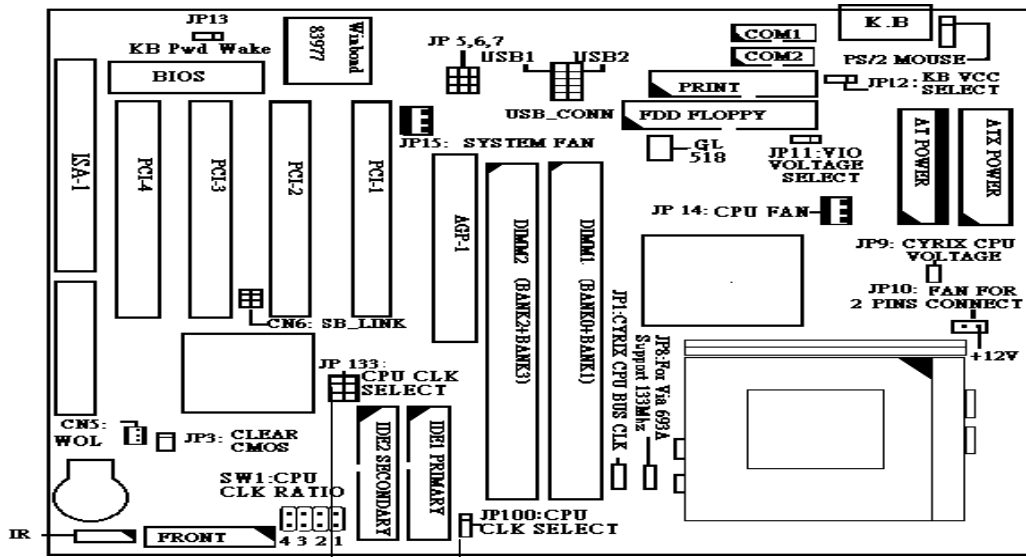

1, MANUAL

CLK TYPE	CPU CLK		BUS CLK		BUS CLK (Mhz)
	JP100	JP133	JP100	JP133	
MANUAL					66
MANUAL					75
MANUAL					83
MANUAL					100
MANUAL					103
MANUAL					110
MANUAL					112
AUTO DETECT					66/100

- * Under The Conditions That When User Use A “ Better “ SDRAM And Vga Card
- * We Suggest To Setup The CPU CLK : $133 \times 2X = 266$ $133 \times 2.5X = 333$
(For Example) $133 \times 3X = 400$

Warning:

the frequency spec.of intel chipset bus clock is setted as 100MHZ
When you set the frequency of chipset over 100MHZ.We don't promise
the over 100MHZ setting could keep the system continue to work stable.

2,Auto Detect (66/100MHZ)

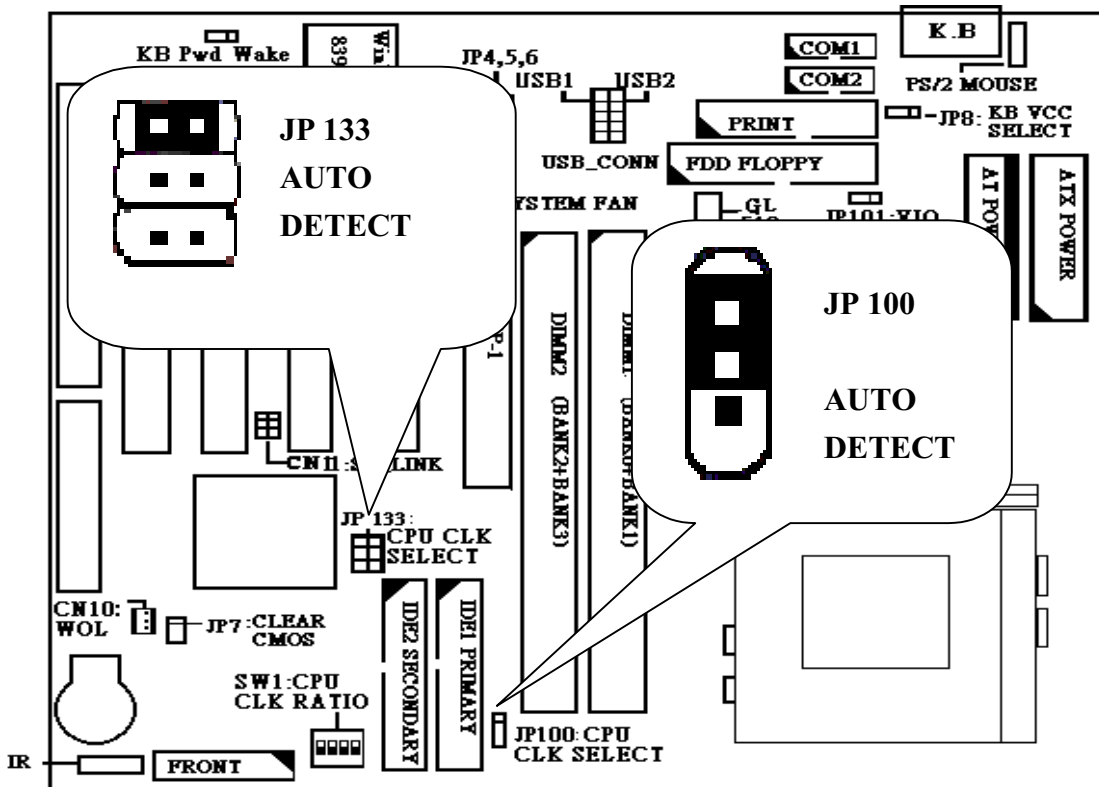

**(3)QUICK INSTALL CPU
INTEL ZIF SOCKET 370 CPU CLOCK CPU RATIO
CELERON CPU**

1,CELERON 370 CPU

Product Name	BUS CLK (MHZ)	Multiplier	SW1				Product Name	BUS CLK (MHZ)	Multiplier	SW1			
			4	3	2	1				4	3	2	1
CELERON 300	66	4.5X					CELERON 433	66	6.5X				
CELERON 333	66	5X					CELERON 466	66	7X				
CELERON 366	66	5.5X					CELERON 500	66	7.5X				
CELERON 400	66	6X											

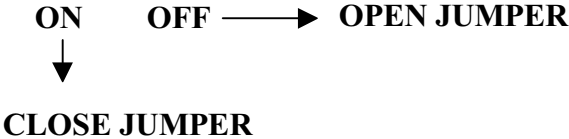

- * The M/B Design Auto-Detect CPU BUS CLK 66 & 100 MHZ Frequency
- * No Jumper Needed For Setting .
- * For 100 MHZ BUS CLK . We Suggests Using “ PC – 100 “ SDRAM SPEC .
- * For Better Reliability . We Suggests Using SPD (Serial Port Data) SDRAM SPEC

(4) The Frequency table for PCI AND AGP





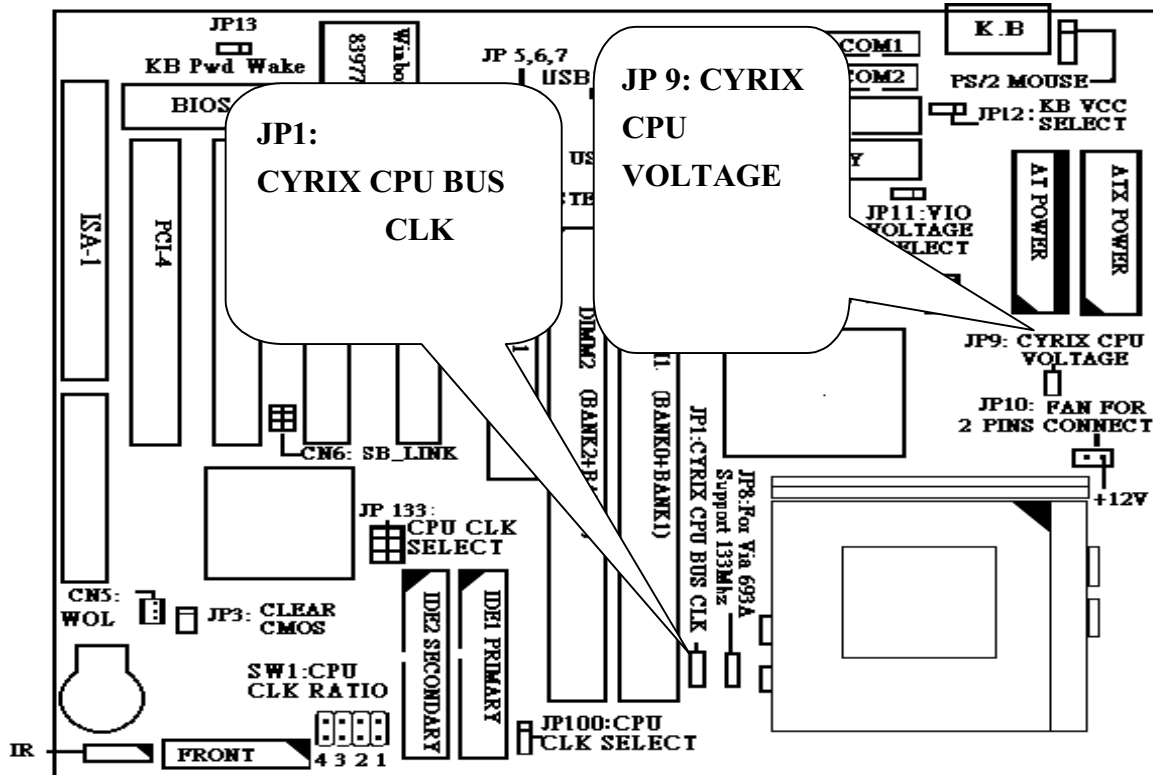

BUS CLK (MHZ)	PCI (MHZ)	AGP(MHZ)
66	33.4	66
75	37.5	75
83	41.65	83
100	33.3	66
103	34.3	68.6
110	36.67	110
112	37.33	74.6
115	38.33	115
120	40.00	120
124	31.00	80
133	33.25	88.6
140	35.00	93.3
150	37.50	100

(5) CYRIX CPU INSTALL
JP1: CYRIX CPU BUS CLK
JP9:CYRIX CPU VOLTAGE





1,CYRIX 370 CPU INSTALL (Reserverd for the future CPU)

(1) CYRIX 370 CPU

Product Name	JP1	JP 100	BUS CLK (MHZ)	Multiplier	SW1
Unknown			66	<i>The CPU Multiplier and SW1 setting, Please refer the page 17</i>	
Unknown			100		
Unknown			133		

CYRIX VOLTAGE

JP9	VOLTAGE	<u>Warning:</u> <i>Please setup the voltage must be according to the CPU marking, If CPU voltage under 2.05V, Open the jumper JP9,if 2.10V or beyond 2.1V,please Close the jumper JP9.</i>
	1.8V~2.05V	
	2.10V~2.2V and beyond	

**2-4 VT82C693A+VT82C596B APOLLO PRO-133
JP8: FOR VIA 693A SUPPORT 133MHZ BUS**

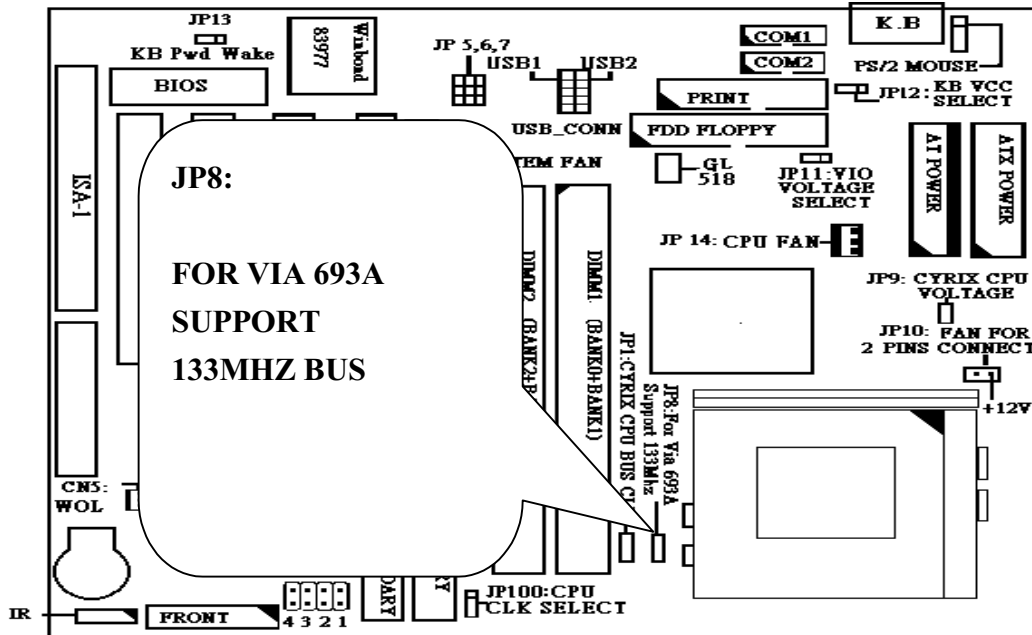

**1, VIA VT 82693A SUPPORT 133 DRAM BUS AND 256MB SDRAM
VIA 693A DRAM BUS**

JP 100	JP8	DRAM BUS
		66
		100
		133

2, VIA 693A ONLY

**This chipset can support 256MB SDRAM and memory size up to 1GB.
(1GB=Double side 256MB SDRAM FOR DIMM1 ,DIMM2.)**

3, VIA 596B ONLY

Two enhanced IDE interfaces supporting both ATA-33 and ATA-66.

2-5 INSTALL MEMORY

(1) PCB LAYOUT AND RELEVANT POSITIONS FOR DIMM X 2

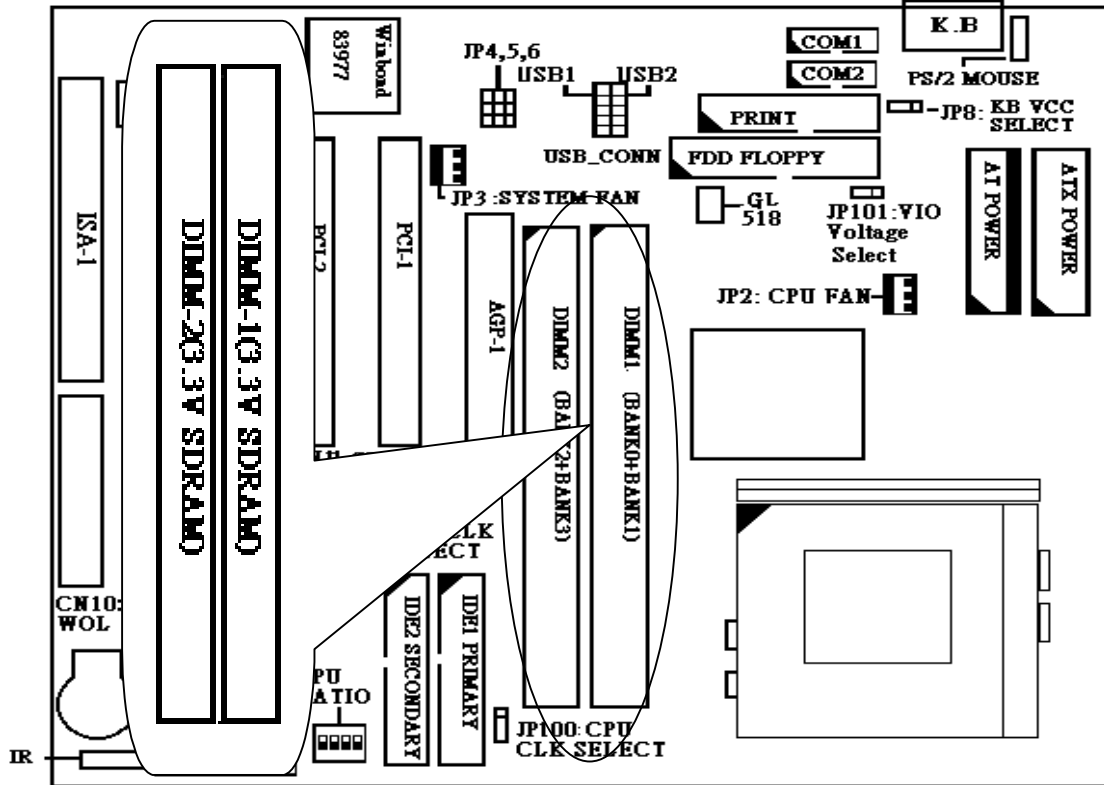

(2) The Supports Different Type Of Settings For The System Memory . There Is No Jumper Nor Connect Needed For Memory Configuration . Following Figures Provides All Possible Memory Combinations

BANK0	BANK1	STATUS
DIMM1	DIMM2	
INSTALLED	NONE	OK
NONE	INSTALLED	OK
NONE	NONE	OK
INSTALLED	INSTALLED	OK

NOTE :

- 1 . SDRAM Module Specification : 3.3 V Only .
- 2 .. For 100 MHZ BUS CLK . We Suggests Using “ PC – 100 “ SDRAM SPEC .
- 3 . For Better Reliability . We Suggests Using SPD (Serial Port Data) SDRAM SPEC .

- 2-6 Genesys logic system Monitor**
The M/B GL518 IC to AUTO-detect
- 1. CPU & System Temperature**
 - 2. CPU & System Voltage**
 - 3. CPU & System FAN Speed**

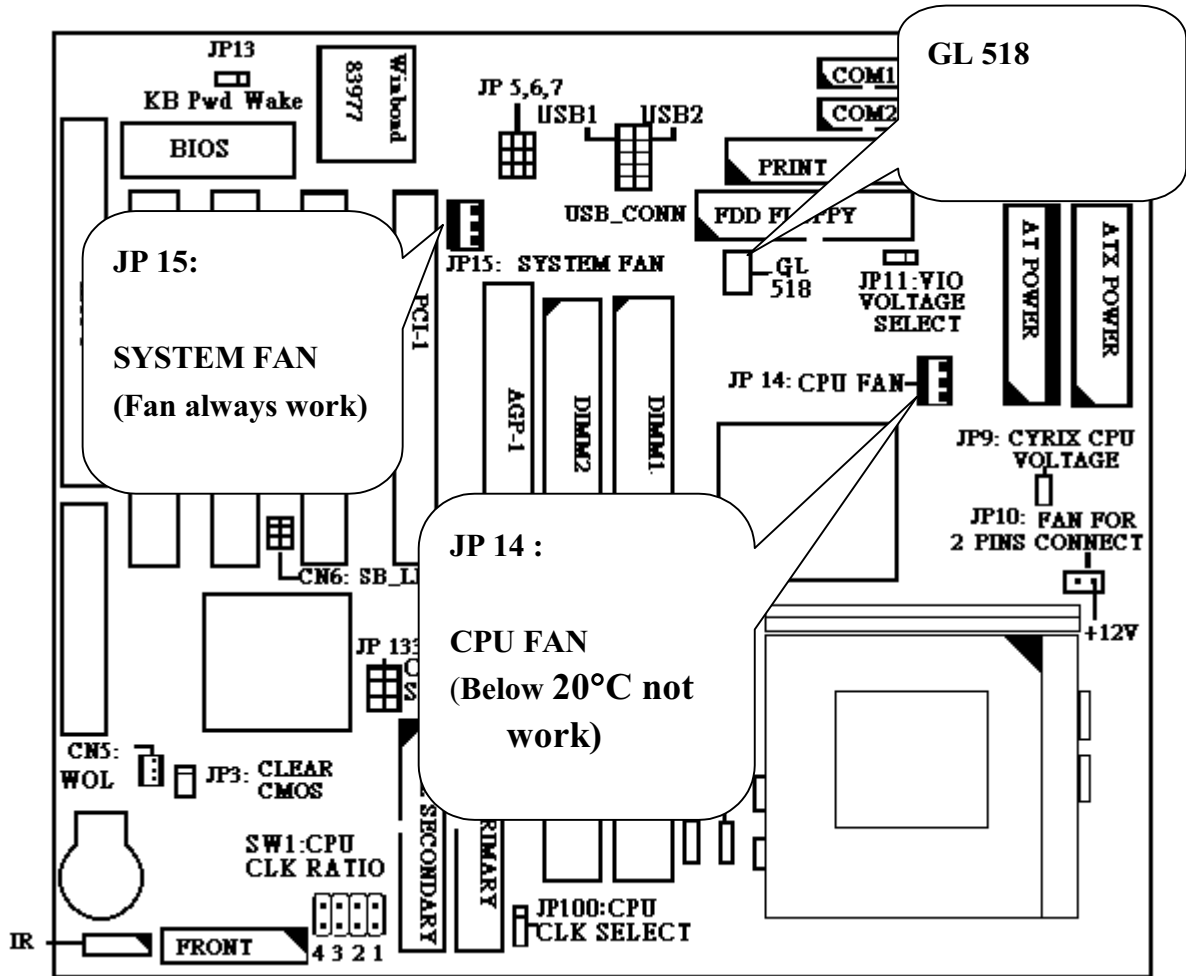

PS:

If the temperature is below 20°C CPU FAN2 (JP14) will not work. The temperature above 27°C CPU FAN2(JP14) will start to work. But SYSTEM FAN1 (JP15) is always work . not limit for temperature.

1. Chipset Features setup

ROM PCI/ISA BIOS(2A69KF99)

CHIPSET FEATURES SETUP

AWARD SOFTWARE. INC.

Auto Configuration	: Enabled	CPU Warning Temperature	: 66°C/151°F
EDO DRAM Speed Selection	: 60ns	Current CPU Temperature	: 29°C/84°F
EDO CAS# MA Wait State	: 2	Current CPUFAN1 Speed	: 0 RPM
EDO RASx# Wait State	: 2	Current CPUFAN2 Speed	: 5454 RPM
SDRAM RAS-to-CAS Delay	: 3	Current Vin3 (V)	: 2.03V
SDRAM RAS Precharge Time	: 3		
SDRAM CAS latency Time	: 3		
SDRAM Precharge Control	: Disabled		
DRAM Data Integrity Mode	: Non-ECC		
System BIOS Cacheable	: Disabled		
Video BIOS Cacheable	: Disabled		
Video RAM Cacheable	: Disabled		
8 Bit I/O Recovery Time	: 1		
16 Bit I/O Recovery Time	: 1	ESC : Quit	↑↓→← : Select Item
Memory Hole At 15M-16M	: Disabled	F1 : Help	PU/PD/+/- : Modify
Passive Release	: Disabled	F5 : Old Values	(Shift) F2 : Color
Delayed Transaction	: Disabled	F6 : Load BIOS Defaults	
AGP Aperture Size (MB)	: 64	F7 : Load Setup Defaults	

**If the temperature is below 20°C CPU FAN2 (JP14) will not work.
 The temperature above 27°C CPU FAN2(JP14) will start to work.
 But SYSTEM FAN1 (JP15) is always work . not limit for temperature.**

CPU Warning Temperature

You can set the temperature of CPU from 50°C to 70°C by yourself when the CPU running and its temperature become too hot then the temperature sensor will be limited CPU speed with your default value and make the system stable.

Current CPU Temperature

Display current CPU Temperature. **Current CPU FAN1 Speed**

Display current system FAN Speed (JP15 CONNECT)

Current CPU FAN2 Speed

Display current CPU FAN Speed (JP14 CONNECT)

Current Vin3(V)

Display current CPU Vcore Voltage

2. Genesys logic system Monitor Driver for Win95/98 AND WinNT.

When you install the Genesys Logic system Monitor driver and you will appear as follows:

Manufacture: Genesys Logic System Monitor

Polling interval	4 seconds		
Temperature			
Cpu Over-Heat	60 (celsius)	<input checked="" type="checkbox"/> Celsius	
Cpu Hysterisis	60	<input type="checkbox"/> Fahrenheit	
Cpu temperature	30		
Current Voltage(V) High Limit Low Limit Voltage			
3.3v values	3.60	3.00	3.35
12v values	13.20	10.80	12.18
5v values	5.50	4.50	5.08
Vcore values	3.90	1.20	2.75
Fan (rpm) Low Limit Current Speed			
Cpu Fan	2000	4528	
System Fan	1000	0	

UPDATE W/O SAVE

UPDATE AND SAVE

USER SETTING

DEFAULT SETTING

QUIT

HIDE

ALARM WHEN

CPU OVER HEAT

3.3V ABNORMAL

12 V ABNORMAL

5 V ABNORMAL

VCORE ABNORMAL

CPU FAN ABNORMAL

SYSTEM FAN

PS: If your fan rpm is not normal, please check your fan Support auto self-detect fan or not.

SUBJECT : Y2K

AWARD Announcement

**Award BIOS Supports Year 2000 and Beyond
Award Software International Inc. is pleased to
announce that its BIOS software automatically solves
The changeover to the year 2000 ,all Award BIOSes
with the date code July 07,1995,and beyond can now
support all dates to year 2079.**

**For Award BIOSes with earlier release dates,the user
may either simply re-set the system date manually or
use a free utility that will be available from a award at
the end of this year,We will continue our best efforts to
provide customers the technical support they need .if
we can be of any service or if you have any further
questions about this announcement,please do not
hesitate to call us. Thank you so much for your support
of Award.**

This announcement in the

Award web-site www.award.com.tw/news/oct1_96.htm

**If you have any Y2k problem,you can visit the
Award web_site www.Award.com.tw**

3.1 Main Menu

Once you enter the Award BIOS CMOS Setup Utility, the Main Menu will appear on the screen. The Main Menu allows you to select from several setup functions and two exit choices. Use the arrow keys to select among the items and press <Enter> to accept and enter the sub-menu.

ROM PCI/ISA BIOS
CMOS SETUP UTILITY
AWARD SOFTWARE, INC.

STANDARD CMOS SETUP	INTEGRATED PERIPHERALS
BIOS FEATURES SETUP	SUPERVISOR PASSWORD
CHIPSET FEATURES SETUP	USER PASSWORD
POWER MANAGEMENT SETUP	IDE HDD AUTO DETECTION
PNP/PCI CONFIGURATION SETUP	HDD LOW LEVEL FORMAT
LOAD BIOS DEFAULTS	SAVE & EXIT SETUP
LOAD SETUP DEFAULTS	EXIT WITHOUT SAVING
Esc : Quit	↑↓→← : Select Item
F10 : Save & Exit Setup	(Shift) F2 : Change Color
Time, Date, Hard Disk Type...	

Note that a brief description of each highlighted selection appears at the bottom of the screen.

Setup Items

The main menu includes the following main setup categories. Recall that some systems may not include all entries.

Standard CMOS Setup

This setup page includes all the items in a standard, AT-compatible BIOS.

BIOS Features

This setup page includes all the items of Award special enhanced features.

Super/User Password Setting

Change, set, or disable password. It allows you to limit access to the system and Setup, or just to Setup.

Chipset Features Setup

This setup page includes all the items of chipset special features.

Power Management Setup

This entry only appears if your system supports Power Management, “Green PC”, standards.

PNP/PCI Configuration Setup

This entry appears if your system supports PNP/PCI.

Load BIOS Defaults

The BIOS defaults have been set by the manufacturer and represent settings which provide the minimum requirements for your system to operate.

Load Setup Defaults

The chipset defaults are settings which provide for maximum system performance. While Award has designed the custom BIOS to maximize performance, the manufacturer has the right to change these defaults to meet their needs.

Integrated Peripherals

This section page includes all the items of IDE hard drive and Programmed Input/ Output features.

IDE HDD Auto Detection

Automatically detect and configure hard disk parameters. The Award BIOS includes this ability in the event you are uncertain of your hard disk’s parameters.

HDD Low Level Format

If supported by your system, this provides a hard disk low level format utility.

Save & Exit Setup

Save CMOS value changes to CMOS and exit setup.

Exit Without Save

Abandon all CMOS value changes and exit setup.

3.2 Standard CMOS Setup

The items in Standard CMOS Setup Menu are divided into 10 categories. Each category includes no, one or more than one setup items. Use the arrow keys to highlight the item and then use the <PgUp> or <PgDn> keys to select the value you want in each item.

ROM PCI/ISA BIOS
STANDARD CMOS SETUP
AWARD SOFTWARE. INC.

Date (mm:dd:yy) : Thu, Jun 4 1998									
Time (hh:mm:ss) : 14 : 11 : 1									
HARD DISKS	TYPE	SIZE	CYLS	HEAD	PRECOMP	LANDE	SECTOR	MODE	
Primary Master	: Auto	0	0	0	0	0	0	AUTO	
Primary Slave	: Auto	0	0	0	0	0	0	AUTO	
Secondary Master	: Auto	0	0	0	0	0	0	AUTO	
Secondary Slave	: Auto	0	0	0	0	0	0	AUTO	
Drive A : 1.44M, 3.5 in.									
Drive B : None									
Floppy 3 Mode Support : Disabled									
						Base Memory : 640K			
						Extended Memory :			
						261120K			
Video : EGA/VGA						Other Memory : 384K			
Halt On : All ,But Keyboard						Total Memory : 262144K			
ESC : Quit ↑↓→← : Select Item PU/PD/+/- : Modify									
F1 : Help (Shift) F2 : Change Color									

Date

The date format is <day>, <date> <month> <year>. Press<F3> to show the calendar.

day	The day, from Sun to Sat, determined by the BIOS and is display-only
date	The date, from 1 to 31 (or the maximum allowed in the month)
month	The month, Jan through Dec.
year	The year, from 1900 through 2099

Time

The time format is <hour><minute><second>. The time is calculated based on

the 24-hour military-time clock. For example, 1 p.m. is 13:00:00

Daylight saving

The category adds one hour to the clock when daylight-saving time begins. It also subtracts one hour when standard time returns

Enabled	Enabled daylight-saving
Disabled	Disabled daylight-saving

Primary Master/ Primary Slave/Secondary Master/ Secondary Slave

The categories identify the types of 2 channels that have been installed in the computer. There are 45 predefined types and 4 user definable types are for Enhanced IDE BIOS. Type 1 to Type 45 are predefined. Type user is user-definable.

Press PgUp or PgDn to select a numbered hard disk type or type the number and press <Enter>. Note that the specifications of your drive must match with the drive table. The hard disk will not work properly if you enter improper information for this category. If your hard disk drive type is not matched or listed, you can use Type “User” to define your own drive type manually.

If you select Type “User”, you will need to know the information listed below. Enter the information directly from the keyboard and press <Enter>. This information should be included in the documentation from your hard disk vendor or the system manufacturer.

If the controller of HDD interface is ESDI, the selection shall be “Type 1”. If the controller of HDD interface is SCSI, the selection shall be “None”. If you select Type “Auto”, BIOS will Auto-Detect the HDD & CD-ROM Drive at the POST stage and showing the IDE for HDD & CD-ROM Drive.

TYPE	drive type
CYLS.	number of cylinders
HEADS	number of heads
PRECOMP	write precom
LANDZONE	landing zone
SECTORS	number of sectors
MODE	mode type

If a hard disk has not been installed select NONE and press <Enter>.

Drive A Type/ Drive B Type

The category identifies the types of floppy disk drive A or drive B that have been installed in the computer.

None	No floppy drive installed
360K, 5.25 in	5-1/4 inch PC-type standard drive; 360 kilobyte capacity
1.2M, 5.25 in	5-1/4 inch AT-type high-density drive; 1.2 megabyte capacity
720M, 3.5 in	3-1/2 inch double-sided drive; 720 kilobyte capacity
1.44M, 3.5 in	3-1/2 inch double-sided drive; 1.44 megabyte capacity
2.88M, 3.5 in	3-1/2 inch double-sided drive; 2.88 megabyte capacity

Video

The category selects the type of video adapter used for the primary system monitor. Although secondary monitors are supported, you do not have to select the type in Setup.

EGA/VGA	Enhanced Graphics Adapter/Video Graphics Array, For EGA, VGA, SEGA, SVGA, or PGA monitor adapters.
CGA 40	Color Graphics Adapter, power up in 40 column mode
CGA 80	Color Graphics Adapter, power up in 80 column mode
MONO	Monochrome adapter, includes high resolution monochrome adapters

Error Halt

The category determines whether the computer will stop if an error is detected during power up.

No errors	Whenever the BIOS detects a non-fatal error the system will be stopped and you will be prompted.
All errors	The system boot will not be stopped for any error that may be detected.
All, But Keyboard	The system boot will not stop for a keyboard error, it will stop for all other errors.
All, But Diskette	The system boot will not stop for a disk error; it will stop for all other errors.
All, But Disk/Key	The system boot will not stop for a keyboard or disk error; it will stop for all other errors.

Memory

The category is display-only which is determined by POST (Power on Self Test) of the BIOS.

Base Memory

The POST will determine the amount of base (or conventional) memory installed in the system. The value of the base memory is typically 512K for systems with 512K memory installed on the motherboard, or 640K for system with 640K or more memory installed on the motherboard.

Extended Memory

The BIOS determines how much extended memory is present during the POST. This is the amount of memory located above 1MB in the CPU'S memory address map.

Other Memory

This refers to the memory located in the 640K to 1024K address space. This is memory that can be used for different applications. DOS uses this area to load device drivers in an effort to keep as much base memory free for application programs. The BIOS is the most frequent user of this RAM area since this is where it shadows RAM.

3.3 BIOS Features Setup

This section allows you to configure your system for basic operation. You have the opportunity to select the system's default speed, boot-up sequence, keyboard operation, shadowing and security.

ROM PCI/ISA BIOS
BIOS FEATURES SETUP
AWARD SOFTWARE. INC.

Anti Virus Protection :	: Enabled	Video BIOS Shadow :	Enabled
CPU Internal Cache	: Enabled	C8000-CBFFF Shadow :	Disabled
External Cache	: Enabled	CC000-CFFFF Shadow :	Disabled
CPU L2 Cache ECC Checking	: Enabled	D0000-D3FFF Shadow :	Disabled
Quick Power On Self Test	: Enabled	D4000-D7FFF Shadow :	Disabled
Boot Sequence	: C, A, SCSI	D8000-DBFFF Shadow :	Disabled
Swap Floppy Drive	: Disabled	DC000-DFFFF Shadow :	Disabled
Boot Up Floppy Seek	: Enabled		
Boot Up NumLock Status	: On		
Gate A20 Option	: Fast		
Typematic Rate Setting	: Disabled		
Typematic Rate (Chars/Sec)	: 6		
Typematic Delay (Msec)	: 250		
Security Option	: Setup		
PCI/VGA Palett Snoop	: Disabled		
OS Select For DRAM > 64MB	: Non-OS2		
Report No FDD For win95	: Yes		
		↑↓→← : Select Item PU/PD/+/- : Modify (Shift) F2 : Color	

Anti-Virus Protection (Trend Chipaway Virus ® on Guard)

When this item is enabled, the Award BIOS will monitor the boot sector and partition table of the hard disk drive for any attempt at modification. If an attempt is made, the BIOS will halt the system and the following error message will appear. Afterwards, if necessary, you will be able to run an antivirus program to locate and remove the problem before any damage is done.

!WARNING!
Disk boot sector is to be modified
Type “Y” to accept write or “N” to abort write
Award Software, Inc.

Enabled	Activates automatically when the system boots up causing a warning message to appear when anything attempts to access the boot sector or hard disk partition table.
Disabled	No warning message will appear when anything attempts to access the boot sector or hard disk partition table.

NOTE:

Many disk diagnostic programs which attempt to access the boot sector table can cause the above warning message. If you will be running such a program, we recommend that you first disable Virus Protection beforehand.

CPU Internal Cache/External Cache

These two categories speed up memory access. However, it depends on CPU/chipset design. The default value is enable.

Enabled	Enabled cache
Disabled	Disable cache

Quick Power On Self Test

This category speeds up Power On Self Test (POST) after you power up the computer. If it is set to Enable, BIOS will shorten or skip some check items during POST.

Enabled	Enable quick POST
Disabled	Normal POST

Boot Sequence

The category determines which drive to search first for the disk operating system (i.e., DOS). Default value is C,A,SCSI.

C,A,SCSI	System will first search for hard disk drive then floppy disk drive.and then SCSI drive.
A,C,SCSI	System will first search for floppy disk drive then hard disk drive.and then SCSI drive.
CDROM, C,A	System will first search for CDROM drive, then hard disk drive and then floppy disk drive.
C, CDROM, A	System will first search for hard disk drive, then CDROM drive, and then floppy disk drive.

SCSI,A,C	System will first search for SCSI drive,then floppy disk drive And then hard disk drive.
LS/ZIP,C	System will first search for LS/ZIP,then hard disk drive.

Swap Floppy Drive

This item allows you to determine whether enable the swap floppy drive or not.
The choice: Enabled/Disabled.

Boot Up Floppy Seek

During POST, BIOS will determine if the floppy disk drive installed is 40 or 80tracks. 360K type is 40 tracks while 760K, 1.2M and 1.44M are all 80 tracks.

Enabled	BIOS searches for floppy disk drive to determine if it is 40 or 80 tracks. Note that BIOS can not tell from 720K, 1.2M or 1.44M drive type as they are all 80 tracks.
Disabled	BIOS will not search for the type of floppy disk drive by track number. Note that there will not be any warning message if the drive installed is 360K.

Boot Up NumLock Status

This allows you to determine the default state of the numeric keypad. By default, the system boots up with NumLock on.

On	Keypad is number keys
Off	Keypad is arrow keys

Gate A20 Option

This entry allows you to select how the gate A20 is handled. The gate A20 is a device used to address memory above 1 Mbytes. Initially, the gate A20 was handled via a pin on the keyboard. Today, while keyboards still provide this support, it is more common, and much faster, for the system chipset to provide support for gate A20.

Normal	keyboard
Fast	chipset

Typematic Rate Setting

This determines if the typematic rate is to be used. When disabled, continually holding down a key on your keyboard will generate only one instance. In other words, the BIOS will only report that the key is down.

When the typematic rate is enabled, the BIOS will report as before, but it will then wait a moment, and , if the key is still down, it will begin the report that the

key has been depressed repeatedly. For example, you would use such a feature to accelerate cursor movements with the arrow keys.

Enabled	Enabled typematic rate
Disabled	Disable typematic rate

Typematic Rate (Chars/Sec)

When the typematic rate is enabled, this selection allows you select the rate at which the keys are accelerated.

6	6 characters per second
8	8 characters per second
10	10 characters per second
12	12 characters per second
15	15 characters per second
20	20 characters per second
24	24 characters per second
30	30 characters per second

Typematic Delay (Msec)

When the typematic rate is enabled, this selection allows you to select the delay between when the key was first depressed and when the acceleration begins.

250	250 msec
500	500 msec
750	750 msec
1000	1000 msec

Security Option

This category allows you to limit access to the system and Setup, or just to Setup.

System	The system will not boot and access to Setup will be denied if the correct password is not entered at the prompt.
Setup	The system will boot, but access to Setup will be denied if the correct password is not entered at the prompt.

*Note: To disable security, select **PASSWORD SETTING** at Main Menu and then you will be asked to enter password. Do not type anything and just press <Enter>, it will disable security. Once the security is disabled, the system will boot and you can enter Setup freely.*

OS Select for DRAM > 64

This item allows you to access the memory that over 64MB in OS/2.

The choice: Non-OS2, OS2.

PCI/ VGA Palette Snoop

It determines whether the MPEG ISA/VESA VGA Cards can work with PCI/VGA or not.

Enabled	When PCI/VGA working with MPEG ISA/VESA VGA Card.
Disabled	When PCI/VGA not working with MPEG ISA/VESA VGA Card.

Video BIOS Shadow

Determines whether video BIOS will be copied to RAM. However, it is optional depending on chipset design. Video Shadow will increase the video speed.

Enabled	Video shadow is enabled
Disabled	Video shadow is disabled

C8000-CBFFF Shadow/DC000-DFFFF Shadow

These categories determine whether option ROMs will be copied to RAM. An example of such option ROM would be support of on-board SCSI.

Enabled	Optional shadow is enabled
Disabled	Optional shadow is Disabled

3.4 Supervisor/User Password Setting

You can set either supervisor or user password, or both of them. The differences between are:

supervisor password: can enter and change the options of the setup menus.

user password: just can enter but do not have the right to change the options of the setup menus.

When you select this function, the following message will appear at the center of the screen to assist you in creating a password.

ENTER PASSWORD:

Type the password, up to eight characters in length, and press <Enter>. The password typed now will clear any previously entered password from CMOS memory. You will be asked to confirm the password. Type the password again and press <Enter>. You may also press <Esc> to abort the selection and not enter a password.

To disabled a password, just press <Enter> when you are prompted to enter the password. A message will confirm the password will be disabled. Once the password is disabled, the system will boot and you can enter Setup freely.

PASSWORD DISABLED.

When a password has been enabled, you will be prompted to enter it every time you try to enter Setup. This prevents an unauthorized person from changing any part of your system configuration.

Additionally, when a password is enabled, you can also require the BIOS to request a password every time your system is rebooted. This would prevent unauthorized use of your computer.

You determine when the password is required within the BIOS Features Setup Menu and its Security option (see Section 4). If the Security option is set to “System”, the password will be required both at boot and at entry to Setup. If set to “Setup”, prompting only occurs when trying to enter Setup.

3.5 Setup/Integrated Peripherals Features Setup

ROM PCI/ISA BIOS(2A69KF99)
 CHIPSET FEATURES SETUP
 AWARD SOFTWARE. INC.

Auto Configuration	: Enabled	CPU Warning Temperature	: Disabled
EDO DRAM Speed Selection	: 60ns	Current CPU Temperature	: 29°C/84°F
EDO CAS# MA Wait State	: 2	Current CPUFAN1 Speed	: 0 RPM
EDO RASx# Wait State	: 2	Current CPUFAN2 Speed	: 5454 RPM
SDRAM RAS-to-CAS Delay	: 3	Current Vin3 (V)	: 2.03V
SDRAM RAS Precharge Time	: 3		
SDRAM CAS latency Time	: 3		
SDRAM Precharge Control	: Disabled		
DRAM Data Integrity Mode	: Non-ECC	Shutdown Temperature	: 75°C/167°F
System BIOS Cacheable	: Disabled		
Video BIOS Cacheable	: Disabled		
Video RAM Cacheable	: Disabled		
8 Bit I/O Recovery Time	: 1		
16 Bit I/O Recovery Time	: 1	ESC : Quit	↑↓→← : Select Item
Memory Hole At 15M-16M	: Disabled	F1 : Help	PU/PD/+/- : Modify
Passive Release	: Enabled	F5 : Old Values	(Shift) F2 : Color
Delayed Transaction	: Disabled	F6 : Load BIOS Defaults	
AGP Aperture Size (MB)	: 64	F7 : Load Setup Defaults	

Auto Configuration

When “Enabled”, this parameter sets and locks some of the optimum values for the chipset and CPU registers automatically. When “Disabled”, this parameter allows those values could be manual changed.

DRAM Speed Selection

When “Auto Configuration” is “Enabled”, this field provides two suit of the optimal values for the chipset and CPU registers. Depend on the different DRAMs’ speed, you could select “60 ns” or “50 ns”. Selects ‘60ns” maybe

causes your system more stable, but also decreases the system's performance.

DRAM Data Integrity Mode

this item allows you to select Non-ECC,ECC. The default is Non-ECC.

System BIOS Cacheable

This item allows you to select Enabled, Disabled. The default is Disabled.

Video BIOS Cacheable

This item allows you to select Enabled, Disabled. The default is Disabled.

Video RAM Cacheable

This item allows you to select Enabled, Disabled. The default is Disabled.

8 bit I/O Recovery Time

This item allows you to select 1 to 7 Wait and NA. The default is 1.

16 bit I/O Recovery Time

This item allows you to select 1 to 4 Wait and NA. The default is 1.

Memory Hole At 15M-16M

Some special add-on cards require a 1MB address space between 15 and 16MB. The documentation for this type of card should prompt you if it need this. The default setting is Disabled.

Passive Release

This item allows you to select Disabled, Enabled. The default is Enabled.

Delayed Transaction

This item allows you to select Enabled, Disabled. The default is Disabled.

AGP Aperture Size (MB)

This item sets the maximum amount of system memory that an AGP card will use to store 3D texture mapping data. The larger aperture makes the better

performance of the 3D function. The settings range from 4MB to 256MB. The default setting is “4MB”.

CPU Warning Temperature

You can set the temperature of CPU from 50°C to 70°C by yourself when the CPU running and its temperature become too hot then the temperature sensor will be limited CPU speed with your default value and make the system stable.

Current CPU Temperature

Display current CPU Temperature.

Current CPU FAN1 Speed

Display current system FAN Speed (JP15 CONNECT)

Current CPU FAN2 Speed

Display current CPU FAN Speed (JP14 CONNECT)

Current Vin3(V)

Display current CPU Vcore Voltage.

Integrated Peripherals

ROM PCI/ISA BIOS(2A69KF99)
INTEGRATED PERIPHERALS
AWARD SOFTWARE, INC.

IDE HDD Block Mode	: Enabled	Onboard Serial Port 2	: 2F8/IRQ3
IDE Primary Master PIO	: Auto	Uart Mode Select	: Normal
IDE Primary Slave PIO	: Auto	Onboard Parallel Port	: 378/IRQ7
IDE Secondary Master PIO	: Auto	Parallel Port Mode	: SPP
IDE Secondary Slave PIO	: Auto		
IDE Primary Master UDMA	: Auto		
IDE Primary Slave UDMA	: Auto		
IDE Secondary Master UDMA	: Auto		
IDE Secondary Slave UDMA	: Auto		
On-Chip Primary PCI IDE	: Enabled		
On-Chip Secondary PCI IDE	: Enabled		
USB Keyboard Support	: Disabled		
Init Display First	: PCI Slot		
POWER ON Function	: Button		
	Only	ESC : Quit	↑↓→← : Select Item
		F1 : Help	PU/PD/+/- : Modify
KBC input clock	: 8MHz	F5 : Old Values	(Shift) F2 : Color
Onboard FDC Controller	: Enabled	F6 : Load BIOS Defaults	
Onboard Serial Port 1	: 3F8/IRQ4	F7 : Load Setup Defaults	

POWER OFF SYSTEM (ATX POWER ONLY)

There are two ways to power off the system. They are “Power Button” and “OS”. (such as Windows® 95 and Windows® 98, after you shut down the OS the system will power off automatically).

POWER ON SYSTEM

This mainboard provides several ways to power on a system that includes “BUTTON ONLY”, “Password”, “Hot KEY”, “Mouse Left” and “Mouse Right”.

After this mainboard has be assembled in a system, depend on the different system configuration

there are several ways to power on the system. Every way maybe has one or more condition(s) or restriction(s) to achieve its function. Please read the following description refer proceeding.

POWER BUTTON(ATX POWER ONLY)

This is an overrideable button. Please refer to page 3-6 for detailed function description. Note that, if the CMOS setup item “POWER ON Function” is set as “Password” (which located at “INTEGRATED PERIPHERALS”, please refer to page 3-5) this button will lose power on function (the power off function is always valid).

KEYBOARD ,KEYBOARD 98 (PASSWORD OR HOT KEY) (ATX POWER ONLY)

Keyboard 98 : New Keyboard 98 support three function key, wake up,doze and suspend function key.

Keyboard: Depend on the different CMOS setup, there are two ways to power on by keyboard they are

“Password” and “Hot KEY”. No matter the setup is “Password” and “Hot KEY”, every time if you change this setup item, the functions will become effective after next time the keyboard

has be initiated during POST (Power On Self Test).

Anytime if you forget the “Password”, just disconnect the AC power about 30-60 seconds then re-connect the AC power, the power button will restore its function and you have a chance to use the power button to turn on the system.

PS/2™ (MOUSE LEFT OR MOUSE RIGHT) (ATX POWER ONLY)

Depend on the different CMOS setup, you could use the “Left Key” or “Right Key” of PS/2™ mouse to turn on the system.

When you use this function you must click the mouse key quickly and continually until the system power on, usually, that maybe need 2-5 times clicked.

No matter the setup is “Mouse Right” or “Mouse Left”, every time if you change this setup item, the functions will become effective after next time the keyboard has be initiated during POST (Power On Self Test).

This function is unavailable while using a COM (serial) port mouse.

PS : ps2 mouse wake up function must be shut down from win95 or win98,this function will

be normal.

IDE HDD Block Mode

This allows your hard disk controller to use the fast block mode to transfer data to and from your hard disk drive (HDD).

Enabled	IDE controller uses block mode.
Disabled	IDE controller uses standard mode.

Enabled is the default.

PCI Slot IDE 2nd Channel

This item allows you designate an IDE controller board inserted into one of the physical PCI slots as your secondary IDE controller.

Enabled	External IDE controller designated as the secondary controller
Disabled	No IDE controller occupying a PCI slot.

Enabled is the default.

IDE PIO

IDE hard drive controllers can support up to two separate hard drives. These drives have a master / slave relationship which are determined by the cabling configuration used to attach them to the controller. Your system supports two IDE controllers—a primary and a secondary—so you have the ability to install up to four separate hard disks.

PIO means Programmed Input / Output. Rather than have the BIOS issue a series of commands to effect a transfer to or from the disk drive, PIO allows the BIOS to tell the controller what it wants and then let the controller and the CPU perform the complete task by themselves. This is simpler and more efficient (and faster).

Your system supports five modes, numbered from 0 (default) to 4, which primarily differ in timing. When *Auto* is selected, the BIOS will select the best available mode. This is true for the next four setup items.

1. IDE Primary Master PIO
2. IDE Primary Slave PIO
3. IDE Secondary Master PIO
4. IDE Secondary Slave PIO

5. On-Chip Primary PCI IDE

As stated above, your system includes two built-in IDE controllers, both of which operate on the PCI bus. This setup item allows you either to enable or disable the primary controller. You might choose to disable the controller if you were to add a higher performance or specialized controller.

Enabled	Primary HDD controller used-Default
Disabled	Primary HDD controller not used.

On-Chip Secondary PCI IDE

As above for the Primary controller, this setup item you either to enable or disable the secondary controller. You might choose to disable the controller if you were to add a higher performance or specialized controller.

Enabled	Primary HDD controller used
Disabled	Primary HDD controller not used.

USB KEYBOARD SUPPORT

If you have USB keyboard, you must be enable this item.

INIT DISPLAY FIRST

When you have the Agp card and PCI card at the same time., you can choice the PCI card or AGP card display first.

KBC INPUT CLOCK

8MHZ is the sytsem default

ONBOARD SERIAL PORT1 AND PORT2

The system default value serial port1 is 3F8/IRQ4

The system default value serial port2 is 2F8/IRQ3

UART MODE SELECT

This mode support the IR function, IR transmittiion from serial port1 and port2.

ON BOARD PARALLEL PORT

The system default value parallel port 378 /IRQ7

PARALLEL PORT MODE

The system support SPP,EPP,ECP,ECP+EPP mode

Support Standard Parallel Port (SPP) compatible with IBM parallel port.

Support Enhanced Parallel Port (EPP) compatible with IEEE 1284 specification

Support Extended Capabilities Port (ECP) compatible with IEEE 1284 specification.

3.6 Setup Power Management

The Power Management Setup allows you to configure you system to most effectively save energy while operating in a manner consistent with your own style of computer use.

ROM PCI/ISA BIOS
POWER MANAGEMENT SETUP
AWARD SOFTWARE. INC.

ACPI function	: Disable	**Reload Global Timer	Events**
Power Management	: User Define	IRQ3 [3-7,9-15],NMI	: Enabled
PM Control by APM	: Yes	Primary IDE 0	: Disabled
Video Off Method	: V/H SYNC+Blank	Primary IDE 1	: Disabled
Video Off After	: Standby	Secondary IDE 0	: Disabled
MODEM Use IRQ	: 3	Secondary IDE 1	: Disabled
Doze Mode	: Disabled	Floppy Disk	: Disabled
Standby Mode	: Disabled	Serial Port	: Enabled
Suspend Mode	: Disabled	Parallel Port	: Disabled
HDD Power Down	: Disabled		
Throttle Duty Cycle	: 62.5%		
VGA Active Monitor	: Disabled		
Soft-off By PWR-BTTN	: Instant off		
Resume by Ring	: Disabled		
Resume by Alarm	: Disabled		
Wake On Lan	: Disabled	ESC : Quit	↑↓→←: Select Item
IRQ 8 Break Suspend	: Disabled	F1 : Help	PU/PD/+/- : Modify
		F5 : Old Values	(Shift) F2 : Color
		F6 : Load BIOS Defaults	
		F7 : Load Setup Defaults	

Soft-off By PWR-BTTN (ATX POWER ONLY)

If the CMOS setup is “Delay 4 Sec”. Selected, this switch’s function is:

- ◆ Press front(11-12):ATX power Switch Connect within 1 seconds, the system will get into Suspend mode.(get into a GREEN mode)
- ◆ Press front(11-12):ATX power Switch Connect beyond 4 seconds, the system will

power off.

If the CMOS setup is “Instant-off” selected, this switch’s function is:

- ◆ Press front(11-12): ATX power Switch Connect, the system will power off instantly.

RTC ALARM (ATX POWER ONLY)

For this function you must set the CMOS setup item “Resume by Alarm” to “enabled” and set the accurate date and time in next two fields. When these date and time are equal to the RTC’s date and time, the system will be power on.

Every time if you change these setup items, the functions will become effective after next time the keyboard has be initiated during POST (Power On Self Test)

MODEM RING-IN(ATX POWER ONLY)

If you have an external MODEM connected to COM A or COM B port, you could power on the system by MODEM via a phone called.

For this function you must set the CMOS setup item “Resume buy Ring or LAN” to “enabled”.

Every time if you change this setup item, the function will become effective after next time the “DMI pool data” has be verified. The system will verify the DMI pool data just before loading the OS (operating system).

This function will be malfunction if any time the system has be power on but the DMI pool data has not be verified.

This function is unavailable while using an internal MODEM card.

WAKE ON LAN(ATX POWER ONLY)

There is a WOL connector (CN10) on mainboard is for connecting a signal cable from a LAN card that supports a Wake On LAN feature. When a LAN card that supports this is installed and connected to the mainboard via this connector, the system will power on when the remote system is access via the LAN.

For this function you must set the CMOS setup item “Resume by Ring or LAN” to “enabled”. Every time if you change this setup item, the function will become

effective after next time the “DMI pool data” has be verified. The system will verify the DMI pool data just before loading the OS (operating system).

This function will be malfunction if any time the system has be power on but the DMI pool data has not be verified.

Power Management

This category allows you to select the type (or degree) of power saving and is directly related to the following modes:

1. Doze Mode
2. Standby Mode
3. Suspend Mode
4. HDD Power Down

There are four selections for Power Management, three of which have fixed mode settings

Disable (default)	No power management. Disables all four modes
Min. Power Saving	Minimum power management. Doze Mode = 1 hr. Standby Mode = 1 hr., Suspend Mode = 1 hr., and HDD Power Down = 15 min.
Max. Power Saving	Maximum power management -ONLY AVAILABLE FOR SL CPU’S . Doze Mode = 1 min., Standby Mode = 1 min., Suspend Mode = 1 min., and HDD Power Down = 1 min.
User Defined	Allows you to set each mode individually. When not disabled, each of the ranges are from 1 min. to 1 from 1 min. to 15 min. and disable.

PM Control APM

When enabled, an Advanced Power Management device will be activated to enhance the Max. Power Saving mode and stop the CPU internal clock.

If the Max. Power Saving is not enabled, this will be preset to *No*.

Video Off Method

This determines the manner in which the monitor is blanked.

V/H SYNC+Blank	This selection will cause the system to turn off the vertical and horizontal synchronization ports and write blanks to the video buffer.
----------------	--

Blank Screen	This option only writes blanks to the video buffer.
DPMS	Initial display power management signaling.

PM Timers

The following four modes are Green PC power saving functions which are only user configurable when User Defined Power Management has been selected.

See above for available selections.

Doze Mode

When enabled and after the set time of system inactivity, the CPU clock will run at slower speed while all other devices still operate at full speed.

Standby Mode

When enabled and after the set time of system inactivity, the fixed disk drive and the video would be shut off while all other devices still operate at full speed.

Suspend Mode

When enabled and after the set time of system inactivity, all devices except the CPU will be shut off.

HDD Power Down

When enabled and after the set time of system inactivity, the hard disk drive will be powered down while all other devices remain active.

Power Down & Resume Events

Power Down and Resume events are I/O events whose occurrence can prevent the system from entering a power saving mode or can awaken the system from such a mode. In effect, the system remains alert for anything which occurs to a device which is configured a *On*, even when the system is in a power down mode.

As above, the choices are *On and Off*. *Off* is the default.

When set *On*, activity will neither prevent the system from going into a power management mode nor awaken it.

- IRQ3 (COM2)
- IRQ4 (COM1)
- IRQ5 (LPT2)
- IRQ6 (Floppy Disk)
- IRQ7 (LPT1)
- IRQ8 (RTC Alarm)

- IRQ9 (IRQ2 Redir)
- IRQ10 (Reserved)
- IRQ11 (Reserved)
- IRQ12 (Reserved)
- IRQ13 (Coprocessor)
- IRQ14 (Hard Disk)
- IRQ15 (Reserved)

Soft-off By PWR-BTTN (For ATX POWER ONLY)

This item allows you to select Delay 4 sec or Instant-off.

Resume By Ring (For ATX POWER ONLY)

This item allows you to select Disabled ,Enabled.

If a Fax Modem was connected with serial ports, the computer will be awoken when it received a signal from outside.

Resume By Ring, Setup for MS-DOS mode

1. Select Resume By Ring: Enabled
2. Save the Value and Exit. This system will Reboot.
3. Power off your system by pressing the power button on the panel.

Resume By Ring, Setup for WIN95 mode

1. Select Resume By Ring: Enabled
2. Save the Value and Exit. This system will Reboot.
3. When you want leave WIN95 , select Shut down. The power off by software

Resume By Alarm (For ATX POWER ONLY)

This item allows you to select Disabled ,Enabled.

Which allows the user setting date(Day/Hour/Minute)

in advance for turning on the system with a range in 30 days.

The system will be awoken on the date according to the user' setup.

Resume By Alarm Setup for MS-DOS mode

1. Select Resume By Alarm: Enabled
2. Set the (Day/Hour/Minute) you desire to wake up your system
3. Save the Value and Exit. This system will Reboot.
4. Power off your system by pressing the power button on the panel.

Resume By Alarm Setup for win95 mode

1. Select Resume By Alarm: Enabled
2. Set the (Day/Hour/Minute) you desire to wake up your system
3. Save the Value and Exit. This system will Reboot.
4. When you want leave WIN95 , select Shut down. The power off by software

3.7 Setup PnP/PCI Configuration

This section describes configuring the PCI bus system. PCI, or Personal Computer Interconnect, is a system which allows I/O devices to operate at speeds nearing the speed the CPU itself uses when communicating with its own special components. This section covers some very technical items and it is strongly recommended that only experienced users should make any changes to the default settings.

ROM PCI/ISA BIOS
PNP/PCI CONFUGURATION
AWARD SOFTWARE. INC.

PNP OS Installed	: No	Used MFM base addr	: N/A
Resources Controlled By	: Manual		
Resources Configuration Data	: Disable		
IRQ-3 assigned to	: PCI/ISA PnP		
IRQ-4 assigned to	: PCI/ISA PnP		
IRQ-5 assigned to	: PCI/ISA PnP		
IRQ-7 assigned to	: PCI/ISA PnP		
IRQ-9 assigned to	: PCI/ISA PnP		
IRQ-10 assigned to	: PCI/ISA PnP		
IRQ-11 assigned to	: PCI/ISA PnP		
IRQ-12 assigned to	: PCI/ISA PnP		
IRQ-14 assigned to	: Legacy ISA		
IRQ-15 assigned to	: Legacy ISA		
DMA-0 assigned to	: PCI/ISA PnP		
DMA-1 assigned to	: PCI/ISA PnP		
DMA-3 assigned to	: PCI/ISA PnP		
DMA-5 assigned to	: PCI/ISA PnP		
DMA-6 assigned to	: PCI/ISA PnP		
DMA-7 assigned to	: PCI/ISA PnP		
		ESC : Quit	↑↓→← : Select Item
		F1 : Help	PU/PD/+/- : Modify
		F5 : Old Values	(Shift) F2 : Color
		F6 : Load BIOS Defaults	
		F7 : Load Setup Defaults	

Resource Controlled by

The Award Plug and Play BIOS has the capacity to automatically configure all of the boot and Plug and Play compatible devices. However, this capability means absolutely nothing unless you are using a Plug and Play Operating system such as Windows® 95.

Choices are Auto and Manual (default).

Reset Configuration Data

This item allows you to determine reset the configuration data or not.

Choices are Enabled and Disabled (default).

IRQ3/4/5/7/9/10/11/12/14/15, DMA0/1/3/5/6/7 assigned to

This item allows you to determine the IRQ / DMA assigned to the ISA bus and is not available to any PCI slot.

Choices are Legacy ISA and PCI/ISA PnP.

PCI IRQ Activated by

This sets the method by which the PCI bus recognizes that an IRQ service is being requested by a device. Under all circumstances, you should retain the default configuration unless advised otherwise by your system's manufacturer.

Choices are Level (default) and Edge.

PCI IDE IRQ MAP to

This allows you to configure your system to the type of IDE disk controller in use. By default, Setup assumes that your controller is an ISA (Industry Standard Architecture) device rather than a PCI controller. The more apparent difference is the type of slot being used.

If you have equipped your system with a PCI controller, changing this allows you to specify which slot has the controller and which PCI interrupt (A,B,C or D) is associated with the connected hard drives.

Remember that this setting refers to the hard disk itself, rather than individual partitions. Since each IDE controller supports two separate hard disk drivers, you can select the INT# for each. Again, you will note that

the primary has a lower interrupt than the secondary as described in “*Slot x Using INT#*” above.

Selecting “*PCI Auto*” allows the system to automatically determine how your IDE disk system is configured.