

Mainboard User Guide

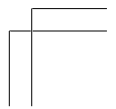
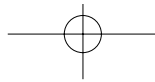
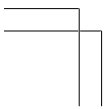
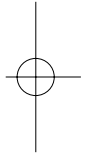

Chapter 1 Main Features	3
Chapter 2 Installation Procedures	
1). Set System Jumpers	6
Clear CMOS	6
BIOS Protect	7
2). Install Memory Modules	9
3). Install the CPU	10
Connect ATX Power	11
4). Install Expansion Cards	12
5). Connect Devices	13
Floppy Diskette Drive Connector	13
IDE Device Connectors	14
Power Connectors	14
Front Panel Block	15
CD Audio-In Connectors	16
SPDIF Out Connector	17
Serial IRQ Connector	17
Chassis Intrusion Connector	18
Fan Connectors	18
Serial ATA Connectors	19
PS/2 Keyboard and Mouse Connector	19
Printer Connector	20
Universal Serial Bus Connectors	21
IEEE 1394 Connector (optional)	21
Serial Port Connector	22
Audio I/O Jacks	23
Front Audio Connector	23
VGA Connector	24
RJ 45 Connector	24

Chapter 3 BIOS Setup

CMOS Setup Utility	24
Standard CMOS Setup	25
Advanced BIOS Features	27
Advanced Chipset Features	29
Integrated Peripherals	30
Power Management Setup	32
PC Health Status	33
Load Optimized Defaults	34
Supervisor/User Password	34
Save and Exit Setup	34
Exit without Saving	34

Main Features

■ CPU

Duron: 1.6 - 1.8 GHz at FSB 266 MHz
Athlon XP:
Palomino Core: 1500+ - 2100+ at FSB 266 MHz
Thoroughbred Core: 1700+ - 2700+ at FSB 266/333 MHz
Barton Core: 2500+ - 3200+ at FSB 333 MHz
2500+ - 3200+ at FSB 400 MHz
Sempron: 3000 + and up

■ Chipset

North Bridge: nVidia nForce 2 IGP-S
South Bridge: nVidia nForce 2 MCP-S

■ Memory

2 Memory Sockets:
Support DDR 266/333/400
Total Memory Size up to 2 GBs

■ Expansion Slots

AGP Slot: Support AGP V3.0 32bit / 66MHz 4X/8X
3 PCI Slots: Support PCI V2.2 32bit / 33MHz

■ IDE Connections

2 IDE Connectors - PIO Mode, Ultra DMA 66/100/133
Up to 4 Devices

■ SATA Connections (Optional)

2 Serial-ATA Connectors, Support 2 Devices.



■ **Audio Features**

ALC 655 (5.1 Channel Audio)
AC97 V2.3 compliant
LINE_IN, LINE_OUT, MIC_IN Jack
Front Audio Pinheaders

■ **I/O Ports**

1 Serial Port
1 VGA Port
1 Floppy Connector
1 Parallel Port
PS/2 Mouse and PS/2 Keyboard
8 USB Ports



■ **LAN**

IEEE802.3 nVidia 10/100 Mbps Fast Ethernet.

■ **Mounting Holes**

6 Holes

■ **Mainboard Size**

9.0 x 9.6 (unit: inch)

■ **IEEE 1394 Ports** *(optional)*

VT6307L™
2 IEEE 1394 ports
1 Bracket with Cable

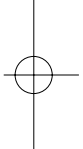

Installation Procedures

The mainboard has several user-adjustable jumpers on the board that allow you to configure your system to suit your requirements. This chapter contains information on the various jumper settings on your mainboard.

To set up your computer, you must complete the following steps:

- Step 1 - **Set system jumpers**
- Step 2 - **Install memory modules**
- Step 3 - **Install the Central Processing Unit (CPU)**
- Step 4 - **Install expansion cards**
- Step 5 - **Connect ribbon cables, cabinet wires, and power supply**
- Step 6 - **Set up BIOS software**
- Step 7 - **Install supporting software tools**



WARNING: Excessive torque may damage the mainboard. When using an electric screwdriver on the mainboard, make sure that the torque is set to the allowable range of 5.0 ~ 8.0kg/cm.

Mainboard components contain very delicate Integrated Circuit (IC) chips. To prevent static electricity from harming any of the sensitive components, you should follow the following precautions whenever working on the computer:

1. Unplug the computer when working on the inside.
2. Hold components by the edges and try not to touch the IC chips, leads, or circuitry.
3. Wear an anti-static wrist strap which fits around the wrist.
4. Place components on a grounded anti-static pad or on the bag that came with the component whenever the components are separated from the system.

1.) Set System Jumpers

Jumpers are used to select the operation modes for your system. Some jumpers on the board have three metal pins with each pin representing a different function. A **1** is written besides pin 1 on jumpers with three pins. To **set** a jumper, a black cap containing metal contacts is placed over the jumper pin(s) according to the required configuration. A jumper is said to be **shorted** when the black cap has been placed on one or two of its pins.



NOTE: Users are not encouraged to change to jumper settings not listed in this manual. Changing the jumper settings improperly may adversely affect system performance.

Clear CMOS

The CMOS RAM is powered by the onboard button cell battery.

To clear the RTC data:

- (1) Turn off your computer;
- (2) Open the system case and disconnect the AC power cord;
- (3) Place the jumper cap onto the pinpair 2-3 for at least 6 seconds to clear CMOS data;
- (4) Place the jumper cap onto the pinpair 1-2 to normal operation;
- (5) Close the system case and connect the AC power cord;
- (6) Turn on your computer until *CMOS checksum error* appears;
- (7) Press the *Delete* key as it boots;
- (8) Enter the BIOS Setup to re-enter user preferences.

 **Normal**
1 2 3 **(Default)**

 **Clear CMOS**
1 2 3

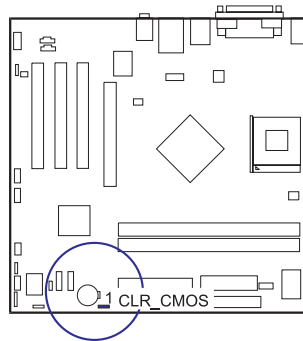

BIOS Write Protect(Optional)

The jumper helps to prevent the boot block table area in the BIOS ROM from being overwritten by mistake.

 **Write Protect
(Default)**

 **Write Enable**

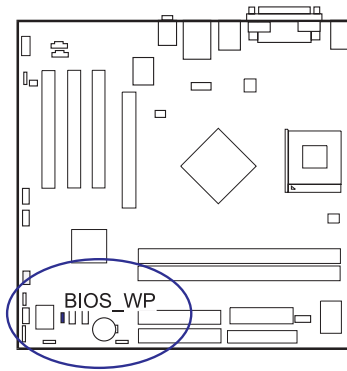

2). Install Memory Modules

1. Locate DDR DIMM sockets on the mainboard.

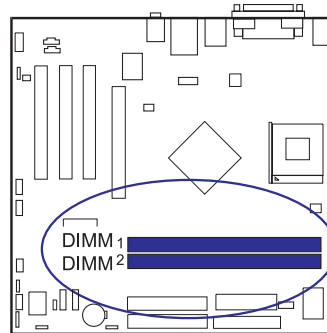

2. Install DDR DIMM straight down into the socket 1 using both hands, then socket 2, and so forth.



3. The clip on both ends of the socket will close up to hold the DDR DIMM in place when the DDR DIMM reaches the socket bottom.



3). Install the CPU

The mainboard has a built-in Switching Voltage Regulator to support CPU Vcore autodetection. That is, it has the ability to detect and recognize the CPU voltage, clock, ratio. Users can view the report about CPU frequency through *Frequency / Voltage Control* on the BIOS Setup Screen.



CAUTION:

1. The heat sink and fan you installed must be approved by AMD.
2. The mainboard must be placed on a solid surface to avoid shaking while install the heat sink and fan are installed on the board.
3. The heat sink must make tight contact with the CPU top.
4. Never run the processor without the heat sink properly and firmly attached. PERMANENT DAMAGE WILL RESULT!

The procedures below shows you how to install your CPU and its fan and heatsink. First of all, locate the CPU socket on the mainboard.

1. Swing the lever upward to 90 degree.
2. Install the CPU, making sure of the pin 1 orientation by aligning the socket corner marking with the socket corner closest to the lever tip. Do not insert the CPU by force. Make sure the processor is fully inserted into the socket on all sides.



Affix the CPU by pressing the lever downward and locking it beside the socket.



3. Place the fan with heatsink on the CPU top and press down on the two plastic clips, hooking them up with the holes on the two sides of the retention module.



4. Press the white bar on each clip down to fasten the fan set on the retention module.



Connect ATX Power

The 20-hole power plug (1st figure) is connected to the ATX power 20-pin pinheaders. The 4-hole 12V power plug (2nd figure) is inserted in the ATX_12V power connector.

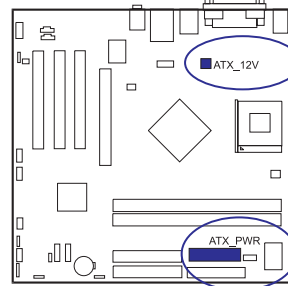
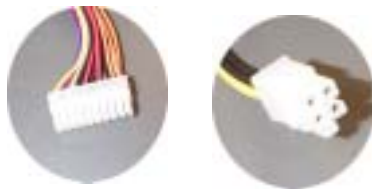

The plug from the power supply can only be inserted in one orientation because of the different hole sizes. Find the proper orientation and push down firmly making sure that the pins are aligned.



4). Install Expansion Cards

This section describes how to connect an expansion card to one of your system expansion slots. Expansion cards are printed circuit boards that, when connected to the mainboard, increase the capabilities of your system. For example, expansion cards can provide video and sound capabilities. The mainboard features one AGP and three PCI bus expansion slots.



CAUTION:

1. Make sure to unplug the power supply when adding or removing expansion cards or other system components. Failure to do so may cause severe damage to both the mainboard and expansion cards.
2. Always observe static electricity precautions.
3. Please read Handling Precautions at the start of this manual.

1. Select an available expansion slot.

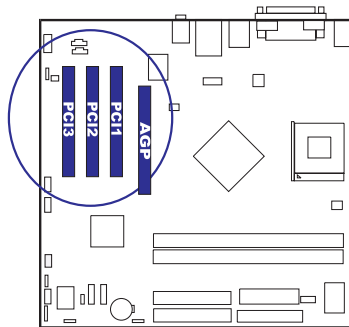

2. Remove the corresponding slot cover from the computer chassis. Unscrew the mounting screw that secures the slot cover and pull the slot cover out from the computer chassis. Keep the slot cover mounting screw nearby.

3. Push the card firmly into the slot. Push down on one end of the expansion card, then the other. Use this rocking motion until the card is firmly seated inside the expansion slot. Secure the card with the screw removed in Step 2.



5). Connect Devices

Floppy Diskette Drive Connector

This connector provides the connection with your floppy disk drive.

Insert the floppy ribbon cable (below) onto the floppy connector.



The colored stripe (indicated by the arrow head, right) of the ribbon cable must be the same side as Pin 1.

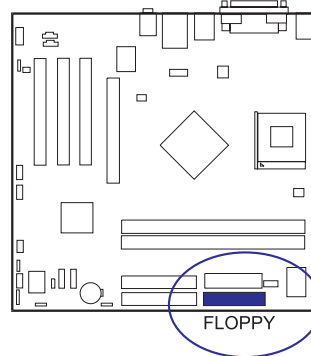

Mainboard User Guide

IDE Device Connectors

The two connectors, IDE1 (PRIMARY) and IDE2 (SECONDARY), are used for your IDE hard disk drives, CD drives, LS-120 drives, or IDE ZIP drives.

Insert the floppy ribbon cable (below) onto the floppy connector.

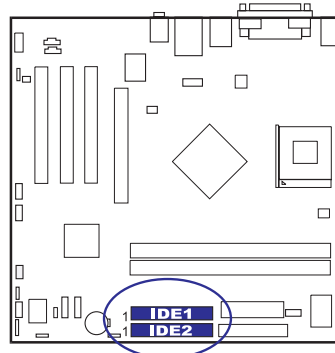

The colored stripe (indicated by the arrow head, right) of the ribbon cable must be the same side as Pin 1.

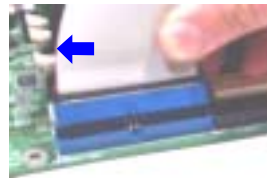

Power Connectors

The 20-pin male block connector is connected to the ATX power supply. The 4-pin male block connector is for the ATX_12V power supply. Both connectors are linked with your ATX power supply. The plug from the power supply can only be inserted in one orientation because of the different hole sizes. Find the proper orientation and push down firmly making sure that the pins are aligned.

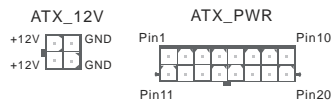

PIN	DEFINITION	PIN	DEFINITION
1	+3.3V	11	+3.3V
2	+3.3V	12	-12V
3	GND	13	GND
4	+5V	14	PS_ON
5	GND	15	GND
6	+5V	16	GND
7	GND	17	GND
8	PWR_GOOD	18	-5V
9	5V_SB	19	+5V
10	+12V	20	+5V

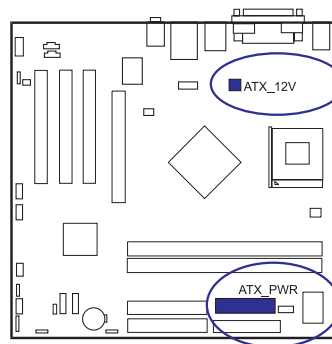

Front Panel Block

This block connector includes the connectors for linking with Power LED (3-pin), HDD LED, power button, power/sleep/message waiting button, and the reset button on the front panel of the system case. Please identify the polarities of the plug wires for the case speaker and LEDs.

The plug wires (below) polarities of these buttons will not affect the function.

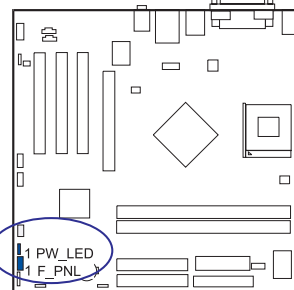

F_PNL
(Intel Spec.)

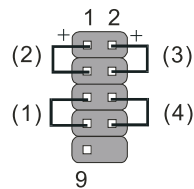

PW_LED
(Power LED, 2/3 Pins)

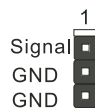

LED	Meaning	State
Off	Off	S4/S5
On	Full On	S0
Flash	Sleep	S1/S3

(1) **Reset Switch** is connected to the reset button. Push this switch to reboot the system instead of turning the power button off and on.

(2) **HDD LED** is connected to the IDE device indicator. This LED will blink

(3) Power (Single and Dual)/Sleep LED

Please refer to the tables below for the representations of LED states.

There is another 3-Pin Power LED connector on board for some cases that have a 3-pin plug.

LED	Meaning	State
Off	Off	S4/S5
Green	Full On	S0
Other Colors	Sleep	S1/S3

(4) **Power Button** is connected with the power button. Pushing this switch allows the system to be turned on and off rather than using the power supply button.

Mainboard User Guide

IR is a pinheader that is used for linking with your IR device to allow transmission of data to another system that also supports the IR feature.

IR
(optional)



SPK
(Speaker)

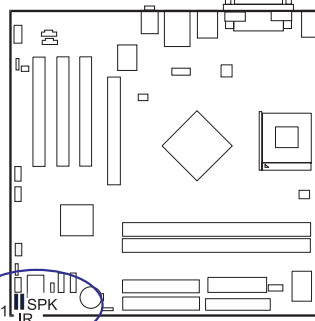
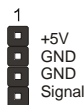

Speaker is connected with the case speaker.

NOTE: To use IR functions you must adjust the BIOS features introduced in the section of *Integrated Peripherals*, Chapter 3, for your IR devices.

CD Audio-In Connectors

The connectors, CD_IN and AUX_IN, are for CD-ROM drive audio analog input use. The pin assignment are: Pin 1 is Left, Pin2 and 3 are GND, Pin 4 is Right.

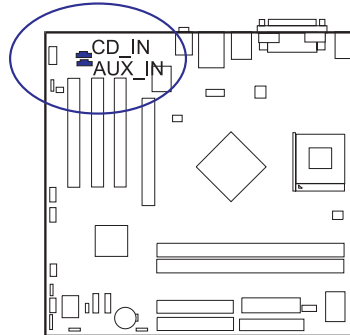
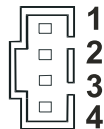

CAUTION: Improper orientation of SPDIF connection may cause damage of your device.

SPDIF Out Connector (Optional)

- 1  +5V
- 2  SPDIF OUT
- 3  GND

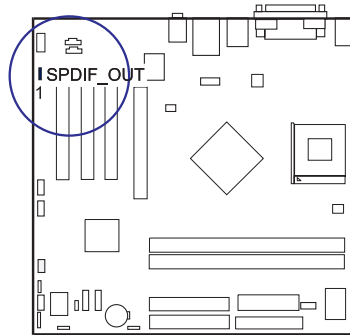

Serial IRQ Connector(Optional)

This 2-pin connector is used for some system integration use.
Pin 1 is Serial IRQ signal, Pin 2 is GND.

- 1  SERIRQ
- 2  N.C.

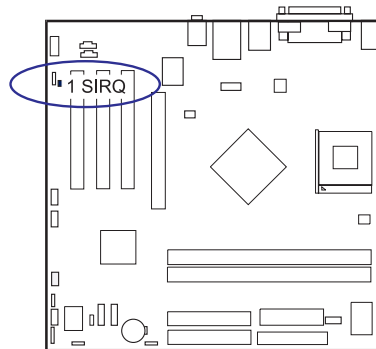

Chassis Intrusion Connector (optional)

This connector is for a chassis designed with intrusion detection feature. It needs a chassis intrusion sensor on the chassis. If a chassis part is moved, the sensor activates and releases a signal in order to this connector to record a chassis intrusion event. Pin1 is +5V Standby, Pin2 is intrusion signal, Pin3 is GND.

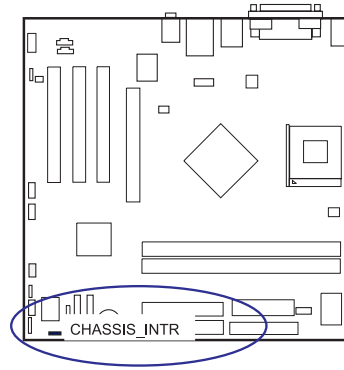



- 1  +5V
- 2  INTR
- 3  GND

Fan Connectors

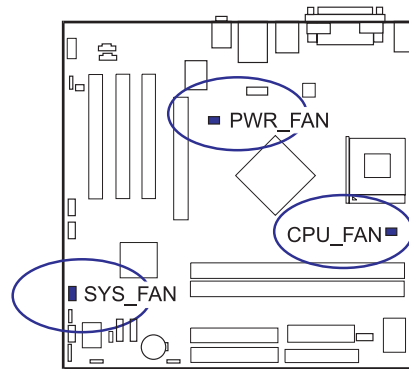
The CPU_FAN connector is for CPU heatsink and cooling fan. The SYS_FAN connector is for system fan on the case. CPU_FAN is Smart Fan controlled. The fan speed depends on CPU temperature. PWR_FAN can be used with the power supply cooling fan. Pin1 is GND, Pin2 is +12V, Pin3 is Fan Speed Signal.



- 1  GND
- 2  +12V
- 3  Fan speed

Serial ATA Connectors (Optional)

The 2 SATA connectors provide you with the connections to Serial ATA devices that conform to the Serial ATA specification. Serial ATA supports all ATA and ATAPI devices. The figures below left are two SATA cables (the top one is for power; the next one is for data). The data cable pin assignments of SATA connector.

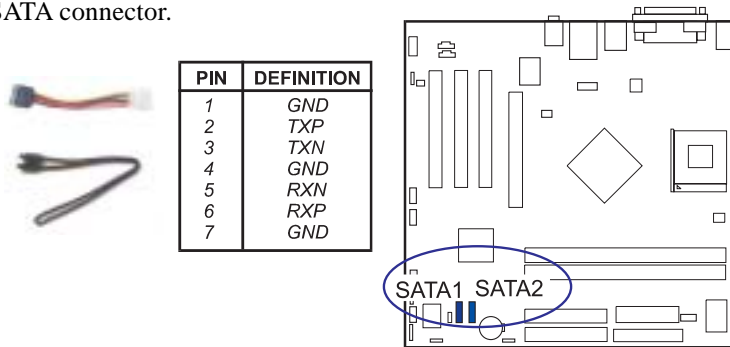

NOTE: To use SATA functions must adjust BIOS features introduced in the section of *Integrated Peripherals*, Chapter 3, for your SATA devices.

PS/2 Keyboard and Mouse Connector

These two 6-pin female connectors are used for your PS/2 keyboard and PS/2 mouse. PS/2 keyboard is purple color and PS/2 mouse is green color

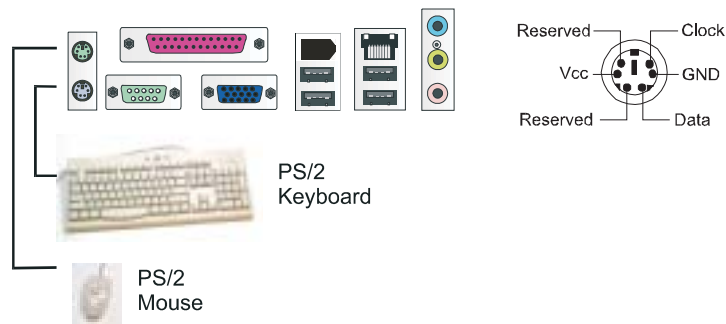

Mainboard User Guide

Printer Connector

This burgundy colored 25-pin D-Sub female connector is attached to your printer.

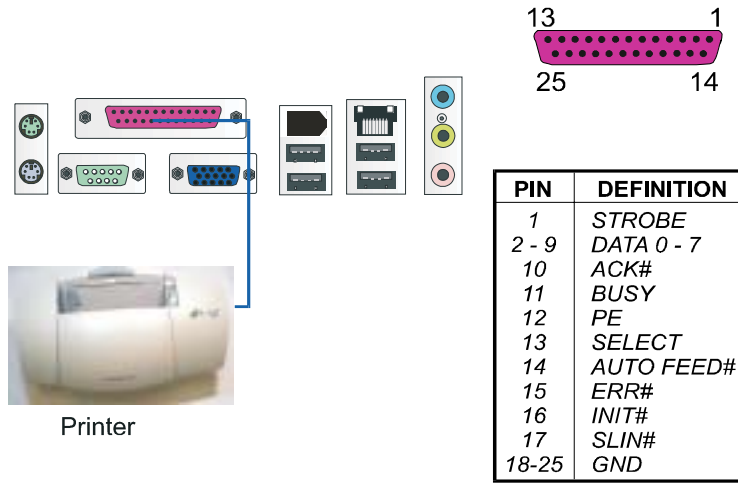

Universal Serial Bus Connectors

The mainbaord has 8 USB ports; 4 USB black jacks that are integrated on the edge of the board, the other 4 USB pinheaders are on the board. They allow to attach to USB devices either from the rear or front panels. The USB cable that comes with your mainboard is used to connecting between the USB pinheaders and rear panel. (See the photo below).

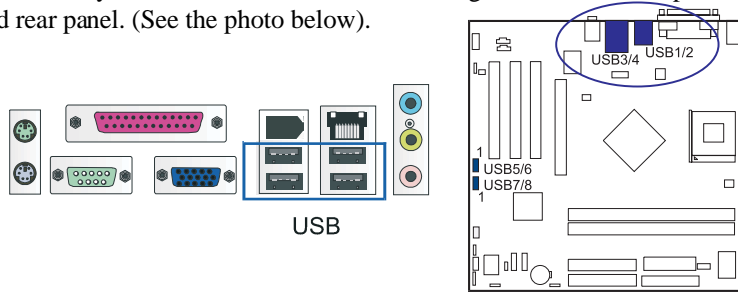

The figure at right shows the pin assignments of the USB5/6. Those of USB6/7 are similar.



- +5V 1
- USB5- 3
- USB5+ 5
- GND 7
- 2 +5V
- 4 USB6-
- 6 USB6+
- 8 GND
- 10 NC

PIN	DEFINITION
1	+5V
2	+5V
3	USB5-
4	USB6-
5	USB5+
6	USB6+
7	GND
8	GND
9	Key
10	N.C

IEEE 1394 Connector (optional)

The mainbaord has 2 1394 ports; 1 1394 black jack that is integrated on the edge of the board, another 1394 pinheader is on the board. They allow to attach to 1394 devices either from the rear or front panels. The 1394 cable that comes with your mainboard is used to connecting between the 1394 pinheader and rear panel.

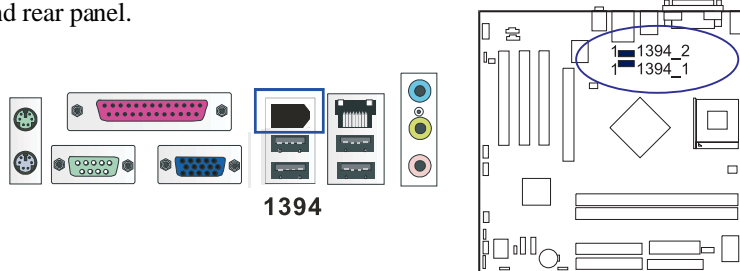

Mainboard User Guide

The 2 optional 1394 pinheaders on the board provides you with two connections with the peripherals which own 1394 connectors by an optional bracket with cable (see the figure below). The pin definitions of the 1394 pinheaders are listed below also.



PIN	DEFINITION
1	TA+
2	TA-
3	GND
4	GND
5	TB+
6	TB-
7	+12V
8	+12V
9	Key
10	GND

Serial Port Connector

COM1

This teal colored 9-pin D-sub male connector allows you to connect with your device that use a serial port, such as a serial mouse or an external modem.

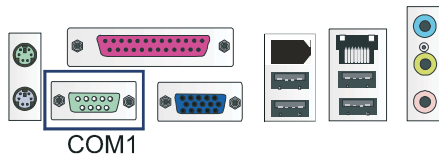

PIN	DEFINITION
1	DCD
2	SIN
3	SOUT
4	DTR
5	GND
6	DSR
7	RTS
8	CTS
9	RI

COM2 (optional)

This pin header allows you to connect your serial port devices via the bracket cable (see the figure below)



PIN	DEFINITION
1	DCD
2	DSR
3	SIN
4	RTS
5	SOUT
6	CTS+
7	PTR
8	RI
9	GND
10	Key

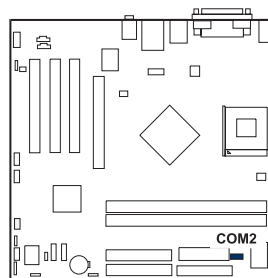

Audio I/O Jacks

LINE_OUT (lime) can be connected to headphones or preferably powered speakers. LINE_IN (light blue) allows tape players or other audio sources to be recorded by your computer or played through the LINE_OUT. MIC_IN (pink) allows microphones to be connected for audio input.

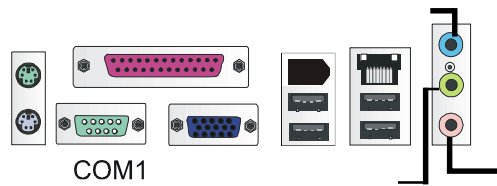

NOTE: LINE_IN, LINE_OUT, and MICROPHONE jacks can be used the 5.1-channel audio output with its software tool.

Front Audio Connector

The mainboard has a front panel audio F_AUDIO connector. It allows users to attach the audio device via the front panel (instead of the rear panel) by a ribbon cable that in some cases.

Its pin definitions are resented below.

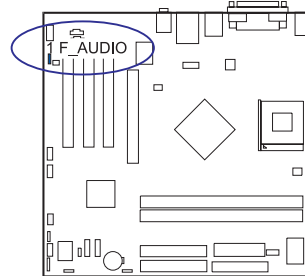
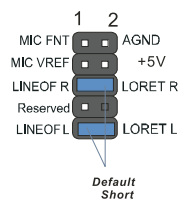

NOTE: If you do not use F_AUDIO, please keep the pinpair 5-6, 9-10 short as default; also, when the front headphone is plugged in, the rear audio output will be disabled.

VGA Connector

This connector is linked to your monitor. The pin assignments are shown at right side.

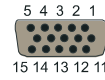
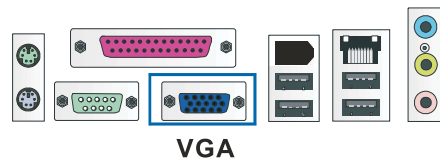

PIN	DEFINITION
1	RED
2	GREEN
3	BLUE
4	VCC
5	GND
6	GND
7	GND
8	GND
9	VCC
10	GND
11	VCC
12	DDC DATA
13	HSYNC
14	VSYNC
15	DDC CLK

RJ45 LAN Connector

The RJ45 jack of the LAN port is used for the LAN cable plug.

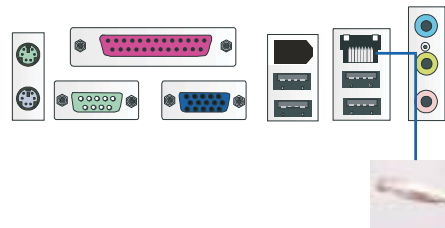

BIOS Setup

The mainboard comes with a chip from Award BIOS that contains the ROM Setup information for your system. This chip serves as an interface between the processor and the rest of the mainboard components. This section explains the information contained in the Setup program and tells you how to modify the settings according to your system configuration.

CMOS Setup Utility

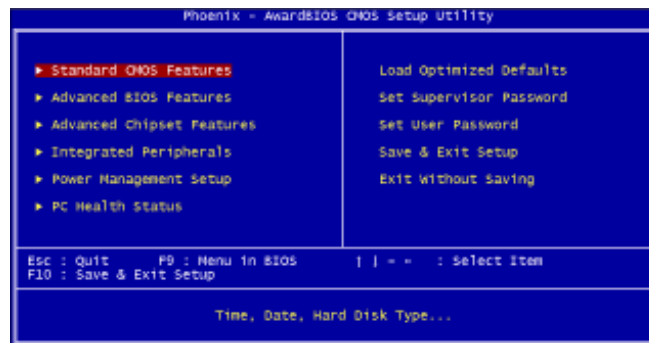

The Setup Utility program allows updates to the mainboard configuration settings. The BIOS setup values will be saved in the CMOS. Setup is executed when the user changes system configurations; changes the system backup battery or the system detects a configuration error and asks the user to run the Setup program. Use the arrow keys to select and press **Enter** to run the selected program.

Standard CMOS Setup



The Standard CMOS Setup screen is displayed above. Each item may have one or more option settings. The system BIOS automatically detects memory size, thus no changes are necessary. Use the arrow keys to highlight the item and then use **PgUp** or **PgDn** keys to select the value you want in each item.

Date

To set the date, highlight the *Date* field and then press **Page Up/Page Down** or +/- keys to set the current date. Follow the month, day and year format.

Time

To set the time, highlight the *Time* field and then press **Page Up/Page Down** or +/- keys to set the current time. Follow the hour, minute, and second format.



Hard Disks

This field records the specifications for all non-SCSI hard drives installed in the system. The onboard PCI IDE connectors provide Primary and Secondary channels for connecting up to four IDE hard disks or other IDE devices. Each channel can support up to two hard disks, the first of which is the *Master* and the second is the *Slave*.

Hard Disk Configurations

Capacity:	The hard disk size. The unit is Bytes.
Cylinder:	The cylinder number of the hard disk.
Head:	The read/write head number at the hard disk.
Precomp:	The cylinder number of which the disk drive changes the write current.
Landing Zone:	The cylinder number on which the disk drive heads (read/write) are seated when the disk drive is parked.
Sector:	The sector number of each track defined on the hard disk.

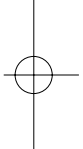
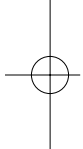

Halt On

This field determines which types of errors will cause the system to halt.

Advanced BIOS Features



Removable Device Priority

This feature allows you to Removable Device Priority.

The options are: Floopy Disks, LS120, ZIP 100, USB-HDD0, USB-HDD1, USB-ZIP0, USB-ZIP1

Hard Disk Boot Priority

This feature will auto detect all hard disks of bootable devices on the system. It also allows you to select hard disk device booting priority.

The options are: Pri.Master, Pri.Slave, Sec.Master, Sec.Slave, USBHDD0, USBHDD1, USBHDD2, Bootable Add-in Cards.

CD-ROM Boot Priority

This feature allows you to select the CD-ROM Boot priority.

The options are: Pri. Master, Pri. Slave, Sec. Master, Sec.Slave, USB-CDROM0,USB-CDROM1

External Cache

This controls the status of teh external (L2) cache area. The default is Enabled. The options are: Enabled, Disabled.

First/Second/Third Boot Device

This feature allows you to select the boot device priority.

The options are: Removable, Hard Disk, CDROM, Legacy Lan, Disable.

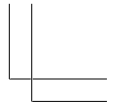
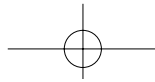
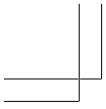

Boot Up Numlock Status

When set to On, allows the BIOS to automatically enable the Num Lock Function when the system boots up. The options are: On, Off.

Security Option

Allows you to set the security level of the system.
The options: Setup, System.

HDD S.M.A.R.T. Capability

S.M.A.R.T. stands for Self-Monitoring and Analysis Reporting Technology which allows your hard disk drive to report any read/write errors and issues a warning with LDCM installed. The options: Disabled, Enabled.

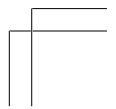
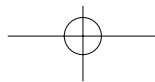
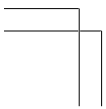
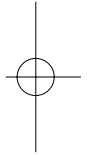
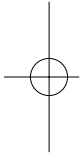

Advanced Chipset Features

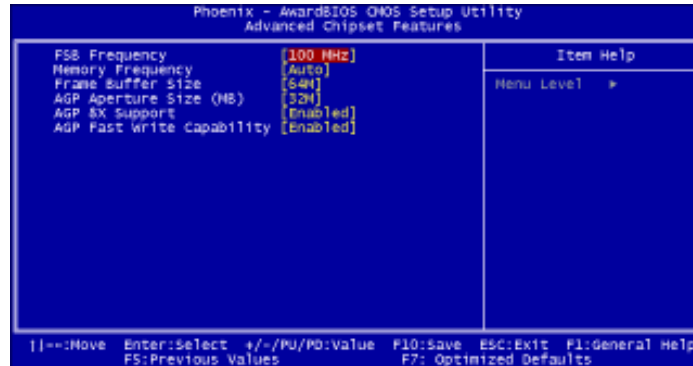

FSB Frequency

This feature allows you to set the FSB frequency
The options are: 133MHz, 166MHz, 200MHz.

Memory Frequency

This feature allows you to set the memory frequency
The options are: 66%, 100%, 133%, 166%, 200%, Auto

AGP Aperture Size

It allows you to select the main memory frame size for AGP use.
The options list presents all provided possibilities.

AGP 8X Support

Enables AGP 8X supports.
The options are: Disabled, Enabled

AGP Fast Write Capability

Enables Fast Write protocol for AGP cards.
The options are: Disabled, Enabled

Integrated Peripherals

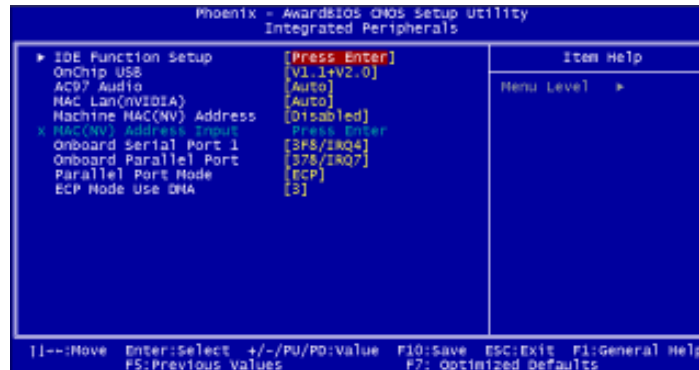

IDE Function Setup

On Chip IDE Channel0/1

When enabled, this allows you to use the onboard primary/secondary PCI IDE. The options are: Enabled, Disabled.



IDE Prefetch Mode

When set at Enabled, it allows data to be posted to and prefetched from the primary IDE data ports. Data prefetching is initiated when a data port read occurs. The read prefetch eliminates latency to the IDE data ports and allows them to be performed back to back for the highest possible PIO data transfer rates. The first data port read of a sector is called the demand read. Subsequent data port reads from the sector are called prefetch reads.

The demand read and all prefetch reads must be of the same size (16 or 32 bits). The options are: Enabled, Disabled.

IDE DMA transfer access

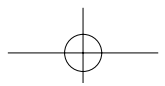
This item allows you to disable the IDE DMA(Direct Memory Access) transfer access function. The options are: Enabled, Disabled.



Mainboard User Guide

OnChip USB

Enables the USB controllers
The options are: V1.1+V2.0, V1.1

AC97 Audio

This feature auto detects if you use a card with a CODEC to enable or disable the AC97 audio function. The options are: Auto, Disabled.

MAC Lan(nVIDIA)

Enables the onboard LAN feature.
The options are: Audio, Disabled

Machine MAC(NV) Address

This feature allows you to select Machine MAC(NV) Address.
The options are: Disabled, Enabled.



Onboard Serial Port 1

If the serial port 1 uses the onboard I/O controller, you can modify your serial port parameters.
The options are: 3F8/IRQ4, 3E8/IRQ4, 2F8/IRQ3, 2E8/IRQ3, Disabled.

Onboard Parallel Port

Allows you to select from a given set of parameters if the parallel port uses the onboard I/O controller.
The options are: Disabled, 378/IRQ7, 278/IRQ5, 3BC/IRQ7.

Parallel Port Mode

Allows you to connect with an advanced printer via the port mode it supports. The options are: SPP, ECP, EPP, EPP+ECP.

ECP Mode Use DMA

This feature allows you to select Direct Memory Access (DMA) channel.
The options are: 1, 3.

Power Management Setup

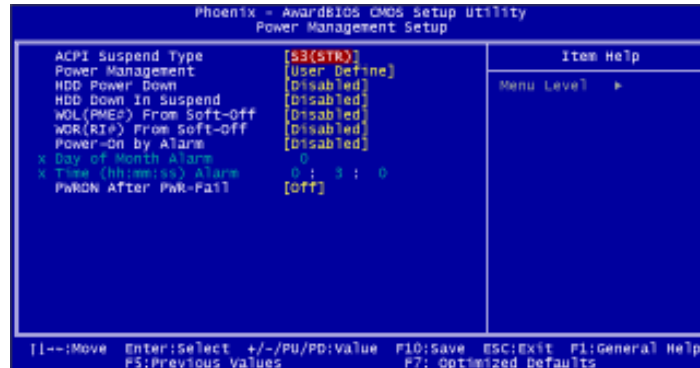

ACPI Suspend Type

This item allows you to select suspend mode when the system is in ACPI mode. The options are: S1 (POS), S3 (PTR), S1&S3.

Power Management

This item allows you to adjust the power management features.

Select *User Define* for configuring your own power management features.

Min Saving initiates all predefined timers in their minimum values. *Max Saving*, on the other hand, initiates maximum values.

The options are: User Define, Min Saving, Max Saving.

HDD Power Down

This option lets the BIOS turn the HDD motor off when the system is in Suspend mode. Selecting 1 Min,...,15 Min allows you to define the HDD idle time before the HDD enters the Power Saving Mode.

The options 1 Min,...,15 Min will not work concurrently. When HDD is in the Power Saving Mode, any access to the HDD will wake the HDD up.

The options are: Disabled, 1 Min,...,15 Min.

Mainboard User Guide

WOL(PME#) From Soft-Off

An input signal from PME on the PCI card awakens the system from a soft off state. Options: Disabled, Enabled.

WOL(RI#) From Soft-Off

An input signal from RI on the PCI card awakens the system from a soft off state. Options: Disabled, Enabled.

Power-On by Alarm

When enabled, you can set the date and time in the following two fields. Any event occurring at the specified date or time awakens the system from power savings mode. Options: Disabled, Enabled.

PWRONAfter PWR-Fail

When the system is shut down owing to the power failure, the system will not be back to power on by itself. This feature allows you to set the system back to which power status of the system when the system power is resumed. The options are: Off, On, Former-Sts.

PC Health Status

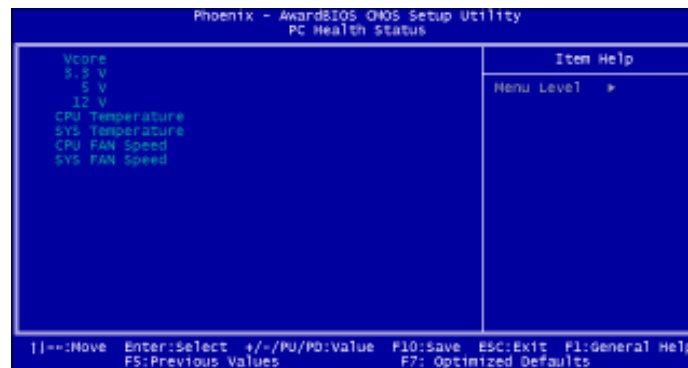

Vcore / 3.3V / 5V / 12V / -12V / CPU Temperature / SYSTEM Temperature / CPU FAN Speed / SYS FAN Speed

These items allow end users and technicians to monitor data provided by the BIOS on this mainboard. It is not user-configurable.



Load Optimized Defaults

This submenu is selected for default settings which provide the best system performance.

Supervisor/User Password

To enable the Supervisor/User passwords, select the item from the Standard CMOS Setup. You will be prompted to create your own password. Type your password up to eight characters and press Enter. You will be asked to confirm the password. Type the password again and press Enter. To disable the password, press Enter twice when you are prompted to enter a password. A message appears, confirming the password is disabled.

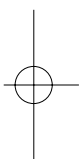
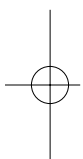

Under the BIOS Feature Setup, if *Setup* is selected under the Security Option field and the Supervisor/User Password is enabled, you will be prompted for a password every time you try to enter the CMOS Setup Utility. If *System* is selected and the Supervisor/User Password is enabled, you will be requested to enter the Password every time you reboot the system or enter the CMOS Setup utility.

Save and Exit Setup

After you have made changes under Setup, press Esc to return to the main menu. Move the cursor to Save and Exit Setup or press F10 and then press Y to change the CMOS Setup. If you did not change anything, press Esc again or move the cursor to Exit Without Saving and press Y to retain the Setup settings. The following message will appear at the center of the screen to allow you to save data to CMOS and exit the setup utility: **SAVE to CMOS and EXIT (Y/N)?**

Exit without Saving

If you select this feature, the following message will appear at the center of the screen to allow you to exit the setup utility without saving CMOS modifications: **Quit Without Saving (Y/N)?**