

Veriton 9100
User's guide

Copyright © 2001 Acer Incorporated
All Rights Reserved.

Veriton 9100
User's guide

Changes may be made periodically to the information in this publication without obligation to notify any person of such revision or changes. Such changes will be incorporated in new editions of this manual or supplementary documents and publications. This company makes no representations or warranties, either expressed or implied, with respect to the contents hereof and specifically disclaims the implied warranties of merchantability or fitness for a particular purpose.

Record the model number, serial number, purchase date, and place of purchase information in the space provided below. The serial number and model number are recorded on the label affixed to your computer. All correspondence concerning your unit should include the serial number, model number, and purchase information.

No part of this publication may be reproduced, stored in a retrieval system, or transmitted, in any form or by any means, electronic, mechanical, photocopy, recording, or otherwise, without the prior written permission of Acer Incorporated.

Model Number : _____

Serial Number: _____

Purchase Date: _____

Place of Purchase: _____

Acer and the Acer Logo are registered trademarks of Acer Inc. Other company's product names or trademarks are used herein for identification purposes only and belong to their respective companies.

Important safety instructions

Read these instructions carefully. Save these instructions for future reference.

1. Follow all warnings and instructions marked on the product.
2. Unplug this product from the wall outlet before cleaning. Do not use liquid cleaners or aerosol cleaners. Use a damp cloth for cleaning.
3. Do not use this product near water.
4. Do not place this product on an unstable cart, stand, or table. The product may fall, causing serious damage to the product.
5. Slots and openings in the cabinet and the back or bottom are provided for ventilation; to ensure reliable operation of the product and to protect it from overheating, these openings must not be blocked or covered. The openings should never be blocked by placing the product on a bed, sofa, rug, or other similar surface. This product should never be placed near or over a radiator or heat register, or in a built-in installation unless proper ventilation is provided.
6. This product should be operated from the type of power indicated on the marking label. If you are not sure of the type of power available, consult your dealer or local power company.
7. Do not allow anything to rest on the power cord. Do not locate this product where persons will walk on the cord.
8. If an extension cord is used with this product, make sure that the total ampere rating of the equipment plugged into the extension cord does not exceed the extension cord ampere rating. Also, make sure that the total rating of all products plugged into the wall outlet does not exceed the fuse rating.
9. Never push objects of any kind into this product through cabinet slots as they may touch dangerous voltage points or short out parts that could result in a fire or electric shock. Never spill liquid of any kind on the product.
10. Do not attempt to service this product yourself, as opening or removing covers may expose you to dangerous voltage points or other risks. Refer all servicing to qualified service personnel.

11. Unplug this product from the wall outlet and refer servicing to qualified service personnel under the following conditions:
 - a. When the power cord or plug is damaged or frayed
 - b. If liquid has been spilled into the product
 - c. If the product has been exposed to rain or water
 - d. If the product does not operate normally when the operating instructions are followed. Adjust only those controls that are covered by the operating instructions since improper adjustment of other controls may result in damage and will often require extensive work by a qualified technician to restore the product to normal condition.
 - e. If the product has been dropped or the cabinet has been damaged
 - f. If the product exhibits a distinct change in performance, indicating a need for service.
12. Replace the battery with the same type as the product's battery we recommend. Use of another battery may present a risk of fire or explosion. Refer battery replacement to a qualified serviceman.
13. **Warning!** Batteries may explode if not handled properly. Do not disassemble or dispose of them in fire. Keep them away from children and dispose of used batteries promptly.
14. Use only the proper type of power supply cord set (provided in your accessories box) for this unit. It should be a detachable type: UL listed/CSA certified, type SPT-2, rated 7A 125V minimum, VDE approved or its equivalent. Maximum length is 15 feet (4.6 meters).



1 First things first	1
Package contents	3
Taking care of your computer	4
Important tips	4
Cleaning and servicing	4
Accessing the online manual	6
2 System tour	7
Features	9
Performance	9
Multimedia	9
Connectivity	9
Front panel	10
Rear panel	12
Keyboard	14
Programmable keys	14
Internet/Suspend keys	15
Multimedia keys	15
Volume control/Mute	15
Cursor keys	16
Lock keys	16
Windows keys	17
Mouse	18
Disk drives	19
3.5-inch floppy disk drive	19
CD-ROM/DVD-ROM drive	19
Hard disk drive	21
BIOS utility	22
3 Setting up your computer	23
Arranging a comfortable work area	25
Adjusting your chair	25
Positioning your Veriton 9100	25
Positioning your monitor	26
Positioning your keyboard	26
Positioning your mouse	26
Connecting peripherals	27
USB Keyboard	27
USB Mouse	28
Monitor	29
Power cable	29
Turning on your computer	31

Contents

Turning off your computer	32
Connecting options	33
Printer	33
Network	34
USB devices	34
Multimedia devices	36
4 Upgrading your computer	39
Installation precautions	41
ESD precautions	41
Preinstallation instructions	41
Post-installation instructions	42
Opening your computer	43
To remove the side panel	43
To reinstall the cover	44
Internal components	46
Replacing the hard disk	47
Installing an expansion card	50
System boards	52
Mainboard layout	52
Audio board	55
Installing additional memory	56
5 Software	59
PC-cillin	62
PC-Doctor	63
BIOS utility	64
Reinstalling programs	65
6 Q & A	67

1 First things first



This chapter describes the contents of your computer package and also provides important tips on how to take care of your computer.

► Package contents

Before you unpack your computer, make sure that you have enough space to set up your computer.

Carefully unpack the carton and remove the contents. If any of the following items are missing or damaged, contact your dealer immediately:

- Veriton 9100
- Items contained in the accessory box
 - USB keyboard
 - USB mouse
- User's guide and installation poster
- Other user documentation and third-party software

▶ Taking care of your computer

Please read the important instructions listed in this section. Following these instructions will help you maximize the durability of your computer.

Important tips

- Do not expose the computer to direct sunlight. Do not place it near sources of heat, such as a radiator.
- Do not subject the computer to magnetic fields.
- Do not expose the computer to rain or moisture.
- Do not spill water on the computer.
- Do not subject the computer to heavy shock or vibration.
- Do not expose the computer to dust and dirt.
- Never place the system on uneven surfaces.
- Do not step on the power cord or place heavy objects on top of it. Carefully route the power cord and any cables away from personal traffic.
- When unplugging the power cord, do not pull on the cord itself but pull on the plug.
- The total ampere rating of the equipment plugged in should not exceed the ampere rating of the cord if you are using an extension cord. Also, the total current rating of all equipment plugged into a single wall outlet should not exceed the fuse rating.
- Check the documentation that came with your software programs to see if you can select other combinations of resolution and color. These adjustments could make viewing the screen more comfortable.

Cleaning and servicing

To clean your computer and keyboard

1. Turn off the computer and unplug the power cord.

2. Use a soft cloth moistened with water and gently wipe the exterior of the computer and the keyboard. Do not use liquid or aerosol cleaners.

To clean your mouse

1. Open the circular cover underneath the mouse.
2. Take out the rubber ball and wipe it with a soft, damp cloth.
3. Put the ball back and close the cover.

To clean your monitor

Make sure that you keep your screen clean. For cleaning instructions, refer to the documentation that came with your monitor.

Accessing the online manual

You may also refer to the Veriton 9100 online manual for information about your computer. To access the online manual, simply double-click on the Veriton 9100 Online icon on your Windows desktop.

2 System tour



This chapter discusses the features and components of your computer.

► Features

Here are just a few of your computer's many features:

Performance

- Intel Pentium® 4 processor with Intel NetBurst™ micro-architecture
- Expandable system memory to a maximum of 2 GB
- Power management function
- 3.5-inch floppy disk drive
- DVD-ROM drive
- High-capacity, Enhanced-IDE hard disk

Multimedia

- 128-bit graphics accelerator installed in the AGP Pro card slot
- 3-D quality audio system via onboard audio controller
- Audio-in/Line-in, Audio-out/Line-out, Headphone-out, Mic-in, and Game/MIDI interfaces



Note: The system has two microphone-in ports (front and rear).





Connectivity

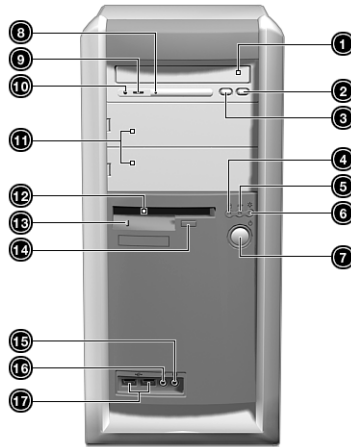

- PS/2 mouse and keyboard interface
- Two serial and one parallel interface
- Universal Serial Bus (USB) ports (available on front and rear panels)
- 10Base-T/100Base-TX network support with remote wake-up function

► Front panel

Your computer's front panel consists of the following:



Label	Icon	Component
1		CD-ROM/DVD-ROM tray
2		Stop/Eject button
3		Fast forward/Skip button
4		Hard disk drive activity light-emitting diode (LED)
5		System activity LED
6		Power LED
7		Power switch
8		CD-ROM/DVD-ROM LED





Label	Icon	Component
9		Volume tuner
10		CD-ROM/DVD-ROM Headphone/ Earphone port
11		5.25-inch drive bays
12		3.5-inch floppy disk drive
13		Floppy disk drive LED
14		Floppy disk drive eject button
15		Speaker-out/Line-out port
16		Microphone-in port*
17		USB ports



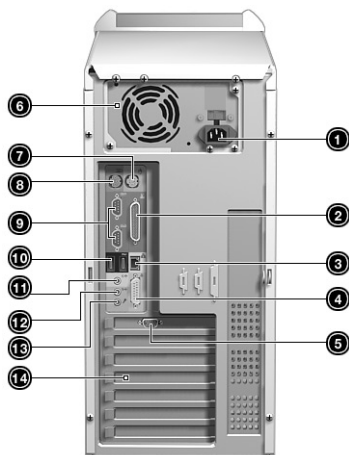



* The system has two microphone-in ports (front and rear).

▶ Rear panel

Your computer's rear panel consists of the following:



Label	Icon	Color	Component
1			Power cord socket
2		White	Network port
3		Burgundy	Parallel/Printer port
4		Gold	Game/MIDI port
5			CRT/LCD monitor port
6			Power supply
7		Green	PS/2 mouse port

Label	Icon	Color	Component
8		Purple	PS/2 keyboard port
9		Teal or Turquoise	Serial port
10		Black	USB ports
11		Lime	Audio-out/Line-out jack
12		Light blue	Audio-in/Line-in jack
13			Microphone-in port*
14			Expansion slots

* The system has two microphone-in ports (front and rear).

For information on how to connect the peripherals, see “Connecting peripherals” on page 27 and “Connecting options” on page 33.

Keyboard

The keyboard that came with your computer has full-sized keys that include separate cursor keys, two Windows keys, and twelve function keys.

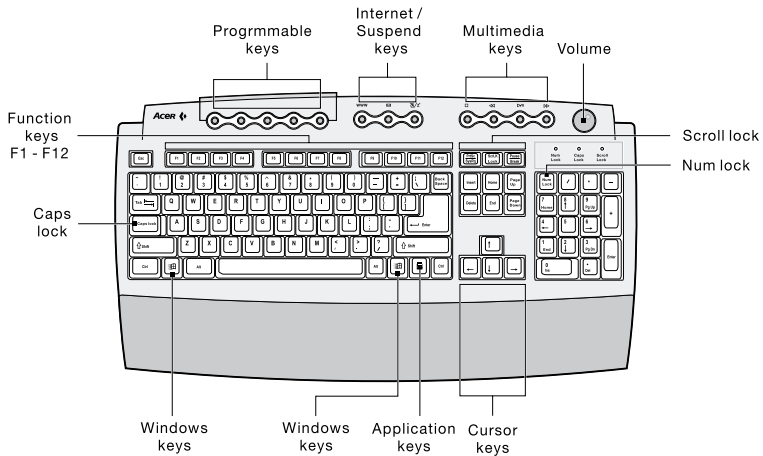



Programmable keys

The programmable keys help you directly access a URL (Web site) or launch any program, file, or application in your system. The fifth key is set to launch the media player. If you want to configure the settings of each key, right click on the Magic Keyboard icon located in your Windows desktop.





Internet/Suspend keys

The Internet/Suspend keys consist of three buttons:

Icon	Key	Description
	Email	Launches your email application.
WWW	Web browser	Launches your current default browser.
	Suspend/Resume	Press this button to put the system to sleep. Press again to wake the system up.

Multimedia keys

The multimedia keys Allow you to play, pause, stop, step forward, or step back a song or movie conveniently using your keyboard.

Icon	Key	Description
	Play/Pause	Press to start playing an audio or video file. Press again to pause.
	Stop	Press to stop playing the audio or video file.
	Forward	Press to skip forward to the next file and start playing.
	Backward	Press to skip backward to the previous file and start playing.

Volume control/Mute



The volume control/mute knob controls the speaker volume. Turn it clockwise or counterclockwise to adjust the volume. Press it to toggle between mute and sound.

Cursor keys

The cursor keys, also called the arrow keys, let you move the cursor around the screen. They serve the same function as the arrow keys on the numeric keypad when the Num Lock is toggled off.



Lock keys

The keyboard has three lock keys which you can toggle on and off to switch between two functions.

Lock Key	Description
Caps Lock	When activated, all alphabetic characters typed appear in uppercase (same function as pressing Shift + <letter>).
Num Lock	When activated, the keypad is set to numeric mode; i.e., the keys function as a calculator (complete with arithmetic operators such as +, -, *, and /).
Scroll Lock	When activated, the screen moves one line up or down when you press the up arrow or down arrow respectively. Take note that Scroll Lock may not work with some applications.

Windows keys

The keyboard has two keys that perform Windows-specific functions.

Key	Description
Windows logo key 	Start button. Combinations with this key perform special functions, such as: <ul style="list-style-type: none">• Windows + Tab: Activate the next Taskbar button• Windows + E: Explore My Computer• Windows + F: Find Document• Windows + M: Minimize All• Shift + Windows + M: Undo Minimize All• Windows + R: Display Run dialog box
Application key 	Opens the applications context menu (same function as clicking the right button of the mouse).

▶ Mouse

Your mouse has one ratchet wheel and two buttons: a left button and a right button. Quickly pressing and releasing the buttons is called clicking. Sometimes, you will need to do a double-click (clicking the same button twice quickly) or a right-click (clicking the right button quickly).

The ratchet wheel in between the two buttons is added to provide easier scrolling capability. By simply moving the wheel with your index finger, you can quickly move through multiple pages, lines, or windows. The wheel may also function as a third button allowing you to quickly click or double-click an icon or a selected item.

For information on how to clean your mouse, see “To clean your mouse” on page 5.

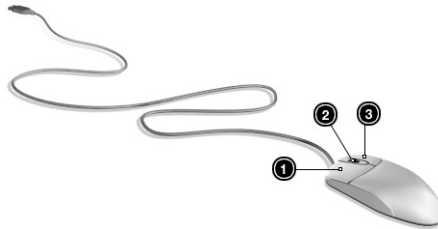

Note: If you are left-handed, refer to your Windows manual for instructions on how to set up your mouse for left-handed use.

► Disk drives

Your computer comes with the following disk drives:

3.5-inch floppy disk drive

Your computer's 3.5-inch floppy disk drive can handle 720-KB and 1.44-MB capacity diskettes.

The floppy diskettes are compact, lightweight, and easy to carry around. Here are some tips on how to take care of your diskettes:

- Always make backup copies of the diskettes that contain important data or program files.
- Keep diskettes away from magnetic fields and sources of heat.
- Avoid removing a diskette from a drive when the floppy drive activity light is on.
- Write-protect your diskettes to prevent accidental erasure. To do this, slide the write-protect tab to the write-protect position.

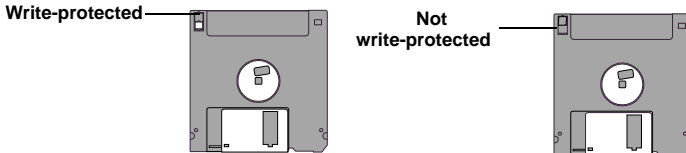

- When you put a label on a 3.5-inch diskette, make sure that the label is properly attached (flat on the surface) and within the labeling area (area with a slight surface depression) on the diskette. An improperly attached label may cause a diskette to get stuck in a drive when you are inserting or removing it.

CD-ROM/DVD-ROM drive

Your computer may come with a CD-ROM or a DVD-ROM drive. This drive is located on the front panel of your computer. The CD-ROM drive allows you to play different types of Compact Discs (CDs), while the DVD-ROM drive allows you to play not only old CD-ROMs, CD-I discs, and video CDs, but new Digital Video Discs (DVDs) as well. DVD or DVD-ROM

is a newer type of CD-ROM that holds a minimum of 4.7GB (gigabytes), enough for a full-length movie.

CDs and DVDs, like diskettes, are also compact, lightweight, and easy to carry around. However, they are more delicate than diskettes and must be handled with extra care.

To insert a CD/DVD into your computer's CD-ROM/DVD-ROM drive:

1. Gently push the eject button located on the front panel.



2. When the disc tray slides open, insert the CD/DVD. Make sure that the label or title side of the disc is facing upward. When holding a disc, hold it by the edges to avoid leaving smudges or fingerprints.

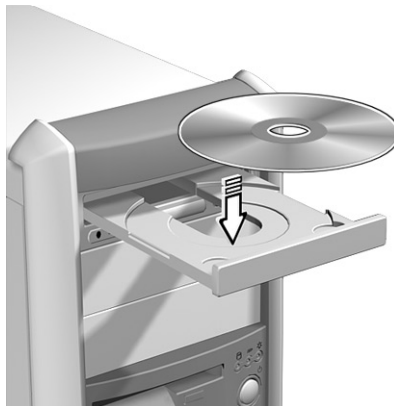

3. Push the eject button again to close the tray.

To take care of your CDs and DVDs:

- Keep your discs in a disk case when not in use to avoid scratches or other damage. Any kind of dirt or damage can affect the data on the disc, impair the disc lens reader on the CD-ROM/DVD-ROM drive, or stop the computer from successfully reading the disc.
- When handling discs, always hold them by the edges to avoid smudges or fingerprints.
- When cleaning discs, use a clean, dust-free cloth and wipe in a straight line from the center to the edge. Do not wipe in a circular motion.
- Clean your CD-ROM/DVD-ROM drive periodically. You may refer to the Cleaning Kit for instructions. Cleaning Kits can be purchased in any computer or electronics shop.

Hard disk drive

Your computer is preinstalled with a high-capacity Enhanced-IDE (E-IDE) hard disk drive. If you want to replace your hard disk or upgrade it, contact your dealer or a qualified service technician for support.

▶ BIOS utility

The BIOS utility is a hardware configuration program built into your computer's Basic Input/Output System (BIOS). Since most computers are already properly configured and optimized, there is no need to run this utility. However, if you encounter configuration problems and get the "Run Setup" message, you will need to run this utility.



.....
Note: Before you run BIOS, make sure that you have saved all open files. The computer reboots immediately after you exit Setup.

To run the BIOS utility, press the key combination **Ctrl+Alt+Esc**.



3 Setting up your computer



This chapter contains step-by-step instructions on how to set up your computer and connect additional peripherals.

► Arranging a comfortable work area

Working safely begins with the arrangement of your work space and the proper use of equipment. For this reason, it is very important to take time and think about how you are going to arrange your work area.

Here are some points to consider:

Adjusting your chair

Having the right kind of chair does not necessarily mean that you'll be properly supported. It is necessary to adjust your chair to fit your body. Proper body posture will make you more comfortable and productive.

- Avoid tilting your chair. If you have a chair that tilts, lock those tilt knobs so that your chair will not tilt forward or backward while you are using your computer.
- Adjust your chair height in such a way that you can sit on it with your thighs parallel to the floor and your feet resting flat on the floor.
- Rest your body on the chair back. Your torso works harder to maintain balance if you do not rest your body on the chair back.

Positioning your Veriton 9100

Take note of the following tips when selecting a location for your computer:

- Do not put your computer near any equipment that might cause electromagnetic or radio frequency interference such as radio transmitters, televisions, copy machines, or heating and air-conditioning equipment.
- Avoid dusty areas and extremes of temperature and humidity.
- You may place your computer beside your desk or under your table, as long as it does not block the space that you need for working and moving.

Positioning your monitor

Place your monitor at a comfortable viewing distance, usually 50 to 60 centimeters away. Adjust the display in such a way that the top of the screen is at or slightly below eye level.

Positioning your keyboard

The location of the keyboard is a very important factor to your posture. Placing it too far away will make your body lean forward forcing you to sit in an unnatural position. Placing it too high will add tension to your shoulder muscles.

- The keyboard should be placed just above your lap. Adjust the keyboard height by flipping the folding stands located under the keyboard.
- Keep your lower arms parallel to the floor as you type. Your upper arms and shoulders should be relaxed. Then try typing with a light touch. If you feel any shoulder or neck strain, stop for a while and check your posture.
- Position your keyboard in front of your monitor. Putting your keyboard beside your monitor will make you turn your head while you type which could add tension to your neck muscles that may later result in neck strain.

Positioning your mouse

- The mouse should be placed on the same surface as your keyboard so that you can reach it with ease.
- Adjust its position to allow enough space for movement without making you stretch or lean over.
- Use your arm to move the mouse. Do not rest your wrist on the table when moving the mouse.

▶ Connecting peripherals

Setting up your computer is easy. For the most part, you only have four things to connect: the mouse, the keyboard, the monitor, and the power cable.

USB Keyboard

Plug the keyboard cable into the USB port  (black port) located on the rear panel of your computer.

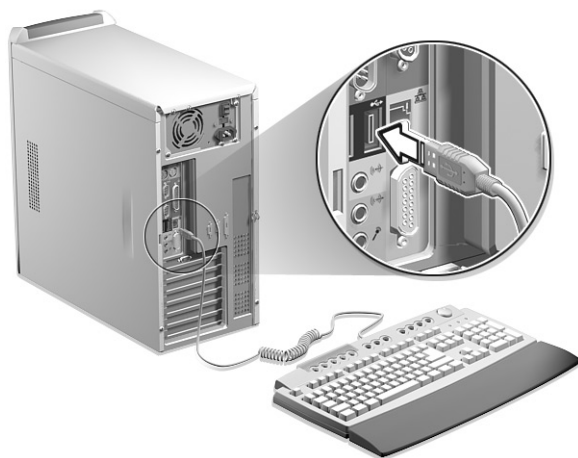

USB Mouse

Plug the mouse cable into the USB port  (black port) located on the front or rear panel of your computer.

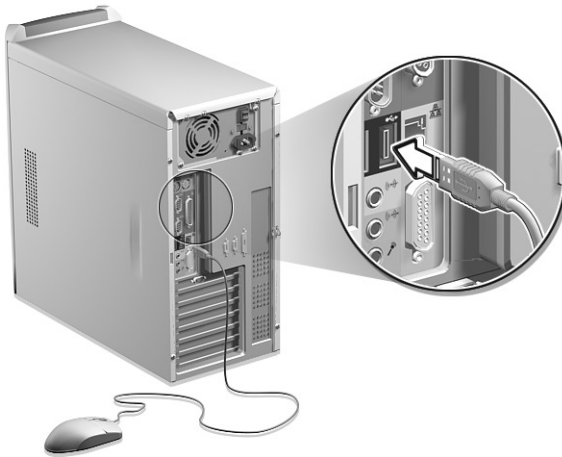

Monitor

To connect a monitor, simply plug the monitor cable into the monitor port located on the rear panel of your computer.

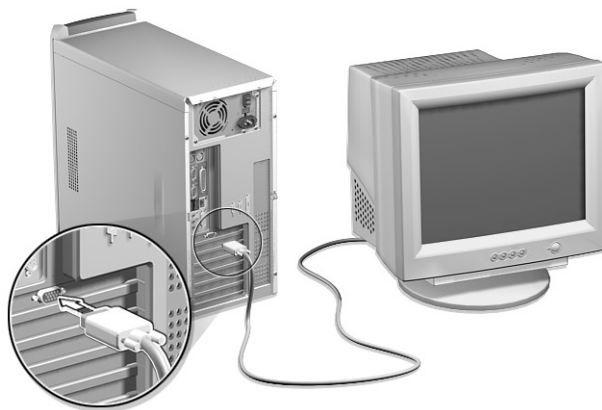

Note: Note: Refer to the monitor manual for additional instructions and information.

Power cable



Caution! Before you proceed, check the voltage range in your area. Make sure that it matches your computer's voltage setting (see the voltage selector switch located on the rear panel of your computer). If they don't match, change your computer's voltage setting according to your area's voltage range.

Plug the power cable into the power cable socket located on the rear panel of your computer. Then plug the other end of the power cable into a power outlet.



▶ Turning on your computer

After connecting the necessary peripherals and plugging in the power cable, you are now ready to turn the computer on and get to work.

To turn on your computer:

1. Turn on all peripherals connected to your computer such as the monitor, printer, fax, speakers, etc.
2. On the front panel of your computer, press the power button.



Important: Make sure that the power cable is properly plugged into an electrical outlet. If you are using a power strip or an AVR (Auto-Voltage Regulator), make sure that it is plugged in and turned on.

▶ Turning off your computer

To turn off your computer, do either of the following:

- From your Windows desktop, click on **Start, Shut Down...** and select **Shut down**; then click on **OK**.
- Turn off all peripherals connected to your computer, and then, press the power switch for at least four seconds. Quickly pressing the button may put the computer in Suspend mode only.

▶ Connecting options

Printer

To connect a printer, plug the printer cable into the parallel port (burgundy port) located on the left panel of your computer. 

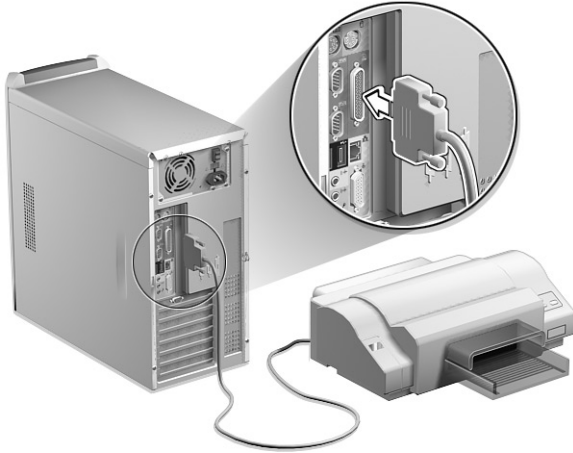

Network

You can connect your computer to a Local Area Network (LAN) using a network cable. To do so, simply plug the network cable into the network port  on the rear panel of your computer.

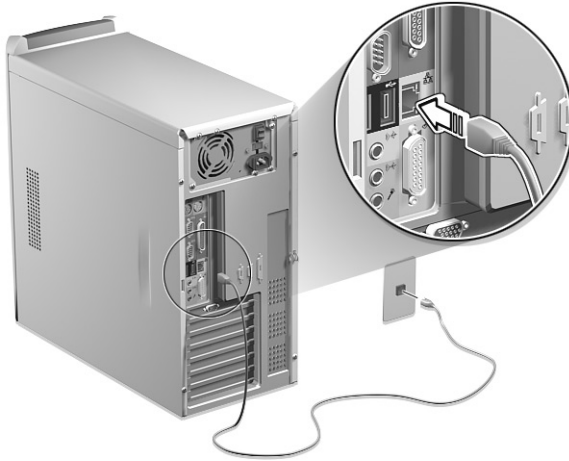

Note: Consult your operating system manual for information on how to configure your network setup.

USB devices

Universal Serial Bus (USB) is a new serial bus design that is capable of cascading low-/medium-speed peripherals (less than 12 Mbps) such as a keyboard, mouse, joystick, scanner, printer and modem. With USB, complex cable connections can be eliminated.

Your computer comes with four USB ports: two each on both the front and rear panels. These ports allow you to connect additional serial devices to your computer without using up its system resources.

To connect a USB device, simply plug the device cable into any of the USB ports (black port).

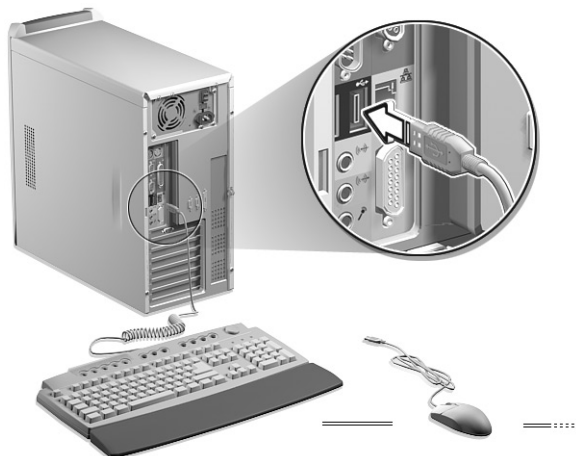

Note: Most USB devices have a built-in USB port which allows you to daisy-chain other devices.

Multimedia devices

You can connect multimedia devices such as speakers, a microphone, headphones or earphones and a joystick (for games). These devices will allow you to take advantage of your computer's multimedia features.

Plug the devices in as follows:

- microphone: connects to the Mic-in jack  (pink jack) located on the front and rear panel of your computer



- earphones, headphones: connect to the Headphone-out jack (lime jack) located on the front panel of your computer



.....

Note: To adjust the volume of the headphones, click on the Volume icon located on the taskbar at the bottom of your screen. When the volume control pops up, drag the volume control lever to the desired level.



- external USB speakers: connect to the Audio-out/Line-out jack (line jack) located on the rear panel of your computer and plug the USB connector into any USB port.

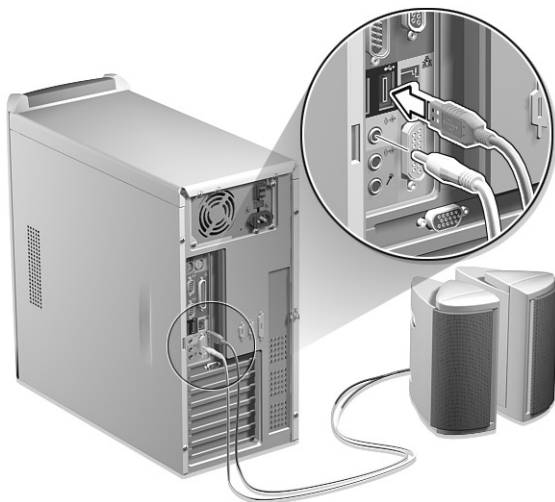

- external CD player: connects to the Audio-in/Line-in jack (🔊) (light blue jack) located on the rear panel of your computer

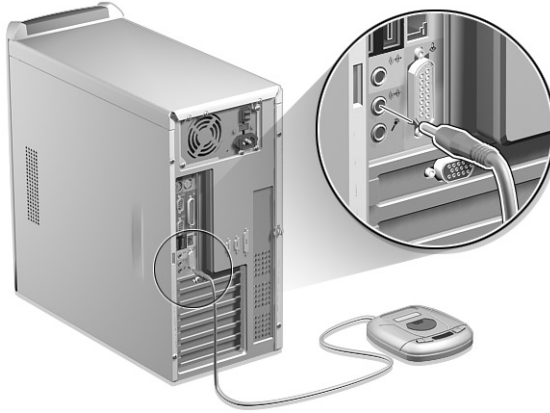

- joystick: connects to the Game/MIDI port (🎮) (gold port) located on the rear panel of your computer

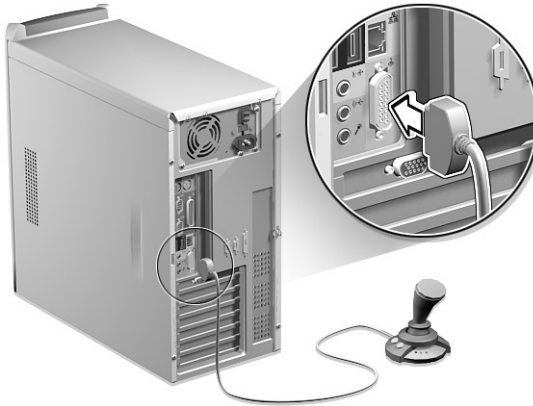

Note: For information on how to configure multimedia devices, consult the documentation that came with each device.



4 Upgrading your computer



This chapter contains instructions on how to upgrade your computer and basic information about your system boards that you will find helpful when performing the upgrade process.

► Installation precautions

Before you install any computer component, we recommend that you read the following sections. These sections contain important ESD precautions along with preinstallation and post-installation instructions.

ESD precautions

Electrostatic discharge (ESD) can damage your processor, disk drives, expansion boards, and other components. Always observe the following precautions before you install a computer component:

1. Do not remove a component from its protective packaging until you are ready to install it.
2. Wear a wrist grounding strap and attach it to a metal part of the computer before handling components. If a wrist strap is not available, maintain contact with the computer throughout any procedure requiring ESD protection.

Preinstallation instructions

Always observe the following before you install any component:

1. Turn off your computer and all the peripherals connected to it before opening it. Then unplug all cables from the power outlets.
2. Open your computer according to the instructions on page 43.
3. Follow the ESD precautions described above before handling a computer component.
4. Remove any expansion boards or peripherals that block access to the DIMM sockets or component connector.
5. See the following sections for specific instructions on the component you wish to install.



.....
Warning! Not turning off the computer properly before you start installing the components may cause serious damage.

Do not attempt the procedures described in the following sections unless you are a qualified service technician.

Post-installation instructions

Observe the following after installing a computer component:

1. See to it that the components are installed according to the step-by-step instructions in their respective sections.
2. Replace any expansion boards or peripherals that you removed earlier.
3. Replace the computer cover.
4. Connect the necessary cables and turn on your computer.

► Opening your computer



.....

Caution: Before you proceed, make sure that you have turned off your computer and all peripherals connected to it. Read the “Preinstallation instructions” on page 41.

You need to open your computer before you can install additional components. See the following section for instructions.

To remove the side panel

1. Turn off your computer and unplug all cables.
2. Place your computer on a flat, steady surface.
3. Remove the four screws from the rear panel using a screwdriver. Set the screws aside.

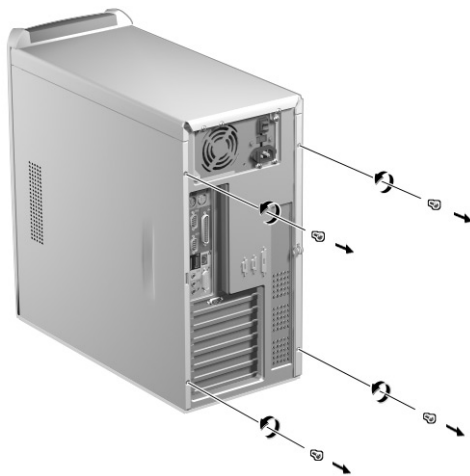

4. Hold one side panel with both hands. Slide it back about an inch and then gently pull it outward to detach it. Do the same thing to the other side.

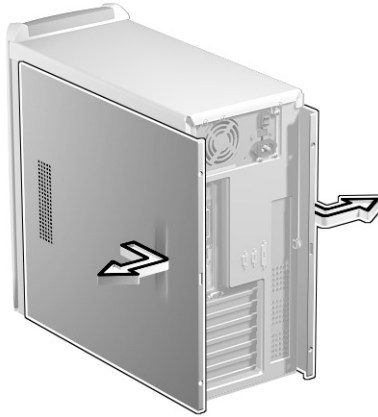

To reinstall the cover

1. Align the side panel's hinges to the housing frame and then push it in to slide it back into place. Do the same thing to the other side.

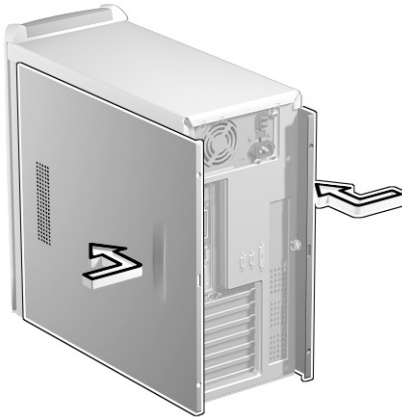

2. Secure the side panels with four screws.

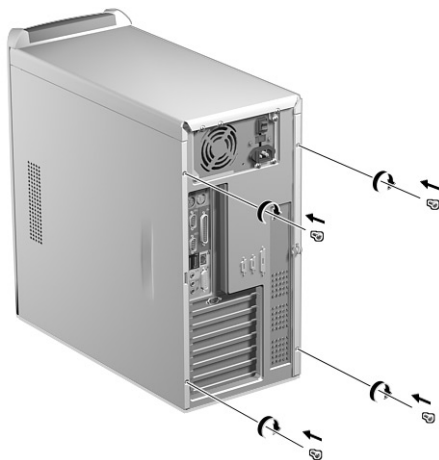

▶ Internal components

The figure below shows what your computer looks like once you remove the cover:

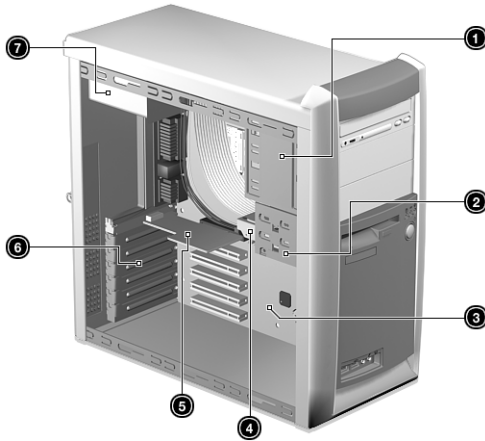

No.	Component
1	5.25-inch drive bays (three bays)
2	3.5-inch drive bays (two bays)
3	Mainboard
4	Hard disk drive
5	VGA card
6	Expansion slots
7	Power supply

► Replacing the hard disk

Follow these steps to replace your computer's hard disk drive:

1. Remove the cover (see page 43).
2. Remove the four screws that hold the hard disk drive to the disk frame. Set the screws aside.

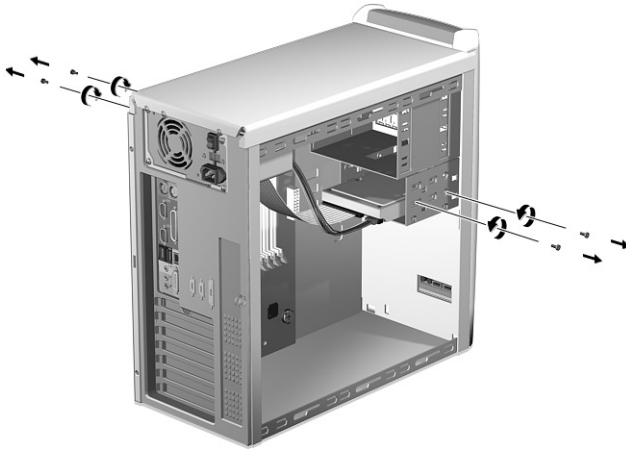

3. (a) Detach the power and disk drive cables from the hard disk drive.
(b) Detach the hard disk from the drive frame.

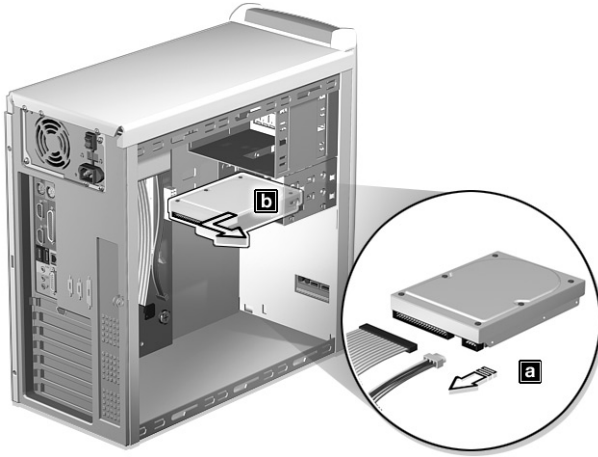

4. (a) Insert the new hard disk drive into the frame.
(b) Connect the power and hard disk drive cables to the new hard disk.

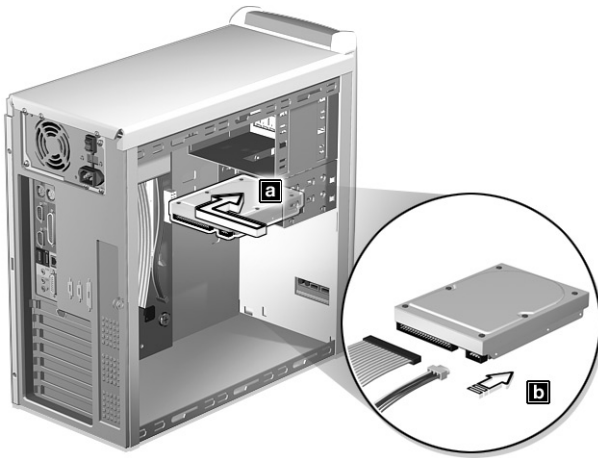

5. Secure it with four screws.

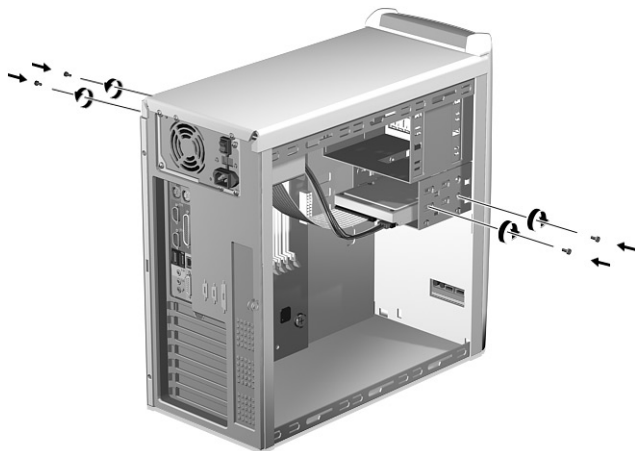

6. Reinstall the cover (see page 44).



Note: Make sure that the other ends of the disk cables are securely connected to their corresponding connectors on the mainboard.

▶ Installing an expansion card



Note: Observe the “Installation precautions” on page 41 when installing or removing a computer component.

To install an expansion card:

1. Remove the cover (see page 43).
2. Locate an empty PCI slot on the mainboard.
3. Remove the screw that holds the bracket to the computer. Save the screw.
4. Pull out the bracket on the housing opposite the selected empty slot.



5. Remove the expansion card from its protective packaging.
6. Align the card with the empty bracket and then insert it into the slot. Make sure that the card is properly seated.

7. Secure the card to your computer with a screw.



8. Reinstall the cover (see page 44).

When you turn on the computer, BIOS (Basic Input/Output System) automatically detects and assigns resources to the newly-installed devices.

System boards

Mainboard layout

The mainboard becomes accessible once you open your computer. It should look like the figure shown below:

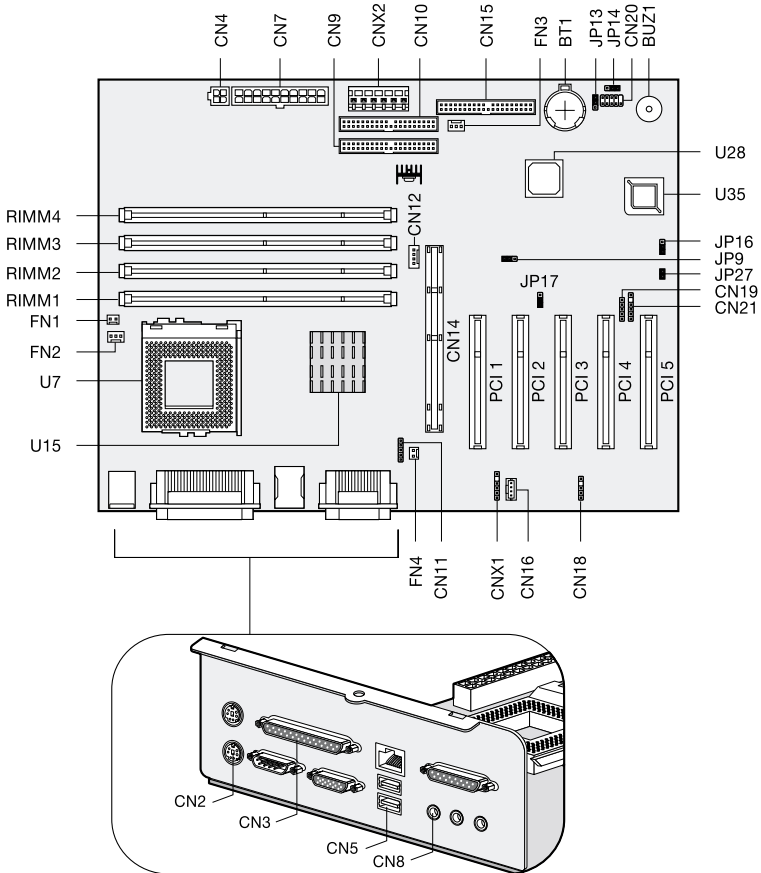

Label	Component
BT1	Battery
BZ1	Buzzer
CN2	PS/2 mouse (upper) and keyboard (lower) ports
CN3	Parallel (upper), serial port 1 (lower right) and serial port 2 (lower left) ports
CN4	Power connector (12V power)
CN5	Network (upper) and USB (lower) ports
CN7	Power connector (ATX power connector)
CN8	MIDI/game (upper), line-out (left), line-in (middle), and mic-in (right) ports
CN9	IDE 2 HDD connector
CN10	IDE 1 HDD connector
CN11	CD-in connector
CN12	AGP Pro power connector
CN14	AGP Pro slot
CN15	FDD Connector
CN16	Fax-voice modem connector
CN18	Wake on modem connector
CN19	ACPI LED connector
CN20	USB2 connector
CN21	IrDA connector
CNX1	Audio 1 connector
CNX2	3.3V and 5V extension power connector
FN1	2-pin CPU fan connector
FN2	3-pin CPU fan connector

Label	Component
FN3	Fan 3 connector
FN4	Fan 4 connector
JP9	Always 2-3 (for 100 MHz clock)
JP12	1-2 Normal* 2-3 Clear CMOS
JP13	1-2 USB2* 2-3 CNR2
JP14	1-2 USB2* 2-3 CNR2
JP16	CPU clock safe Mode 1-2 Normal 2-3 800 MHz
JP17	1-2 Disable onboard EEPROM 2-3 Enable onboard EEPROM
JP27	Intrusion connector
PCI1 to 5	PCI slots 1 to 5
RIMM1 to 4	RIMM sockets 1 to 4
U7	FC-PGA CPU socket
U15	Intel 82850 Chipset
U28	Intel 82801BA Chipset
U35	BIOS chipset

* Default value

Audio board

The audio board that came with your computer should look like the figure that follows.

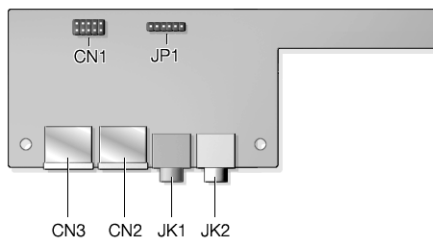

Label	Description
JP1	Audio connector - connects to the AUDIO2 connector of the mainboard
CN1	USB connector - connects to the USB2 connector of the mainboard
CN2 and CN3	USB ports
JK1	Microphone-in port (the system has two microphone-in ports - front and rear)
JK2	Audio-out port

▶ Installing additional memory

The RIMM sockets consist of two channels which means that the RIMM should be installed in pairs. Also, a terminator must be inserted into an empty RIMM.

To properly install a RIMM, choose either one of these configurations:

RIMM slots	Module inserted
RIMM 1 and RIMM 2	RDRAM
RIMM 3 and RIMM 4	CRIMM (terminator)
RIMM 1 and RIMM 2	CRIMM (terminator)
RIMM 3 and RIMM 4	RDRAM
RIMM 1, RIMM 2, RIMM 3, and RIMM 4	RDRAMs



Note: See “Mainboard layout” on page 52 for the location of the RIMM sockets.

Installing a RIMM or a terminator

To install a RIMM or a terminator, align it with the socket and press it down until the holding clips secure the RIMM or the terminator in place.



Note: The RIMM socket is slotted to ensure proper installation. If you slip in a RIMM but it does not completely fit, you may have inserted it the wrong way. Reverse the orientation of the RIMM.

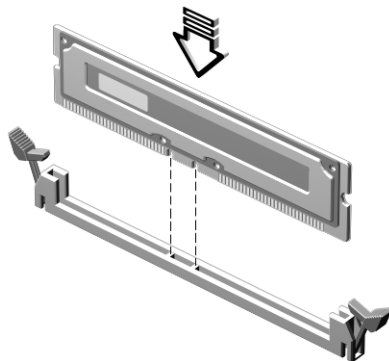

Removing a RIMM or a terminator

To remove a RIMM or a terminator, press the holding clips on both sides of the socket outward to release it.



Note: Place your forefingers on the top of the RIMM or the terminator before you press the holding clips to gently disengage it from the socket.

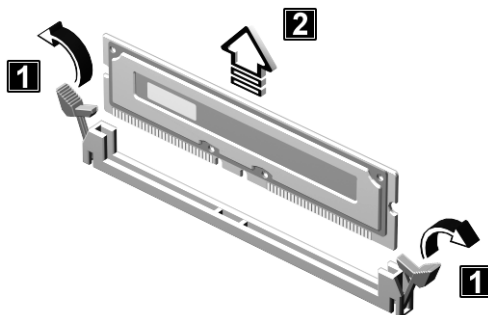

Reconfiguring the system

Reconfigure the system after installing or removing RIMMs.

Follow these steps to reconfigure the system:

1. Reboot the system. A memory error message appears, indicating that the total memory does not match the value stored in CMOS.
2. Press **Ctrl + Alt + ESC**.
3. Press **ESC** twice to exit Setup and reboot the system. The system boots with the new memory configuration.

5 Software



This chapter describes the applications that came with your computer.

Your computer comes with the following applications:

- PC-cillin
- PC Doctor
- BIOS utility

All of the applications that came with your computer are very easy to use. However, if you need more help and information, you may refer to the online help documentation provided in each software application.

- a. Select the snapshot image file you want to restore your critical system files to.
- b. Wait for the results to be displayed.

▶ PC-cillin

PC-cillin is an antivirus program designed to scan and clean computer viruses from your computer's hard drive and floppy drive. To ensure the integrity of your computer data, you should scan your hard drive on a regular basis. Fixes for newly-discovered viruses may not be included in the software provided with your computer. You may contact your software vendor or Trend Micro's Web site (www.trendmicro.com) for updates.

To run PC-cillin:

1. Select the **PC-cillin** icon from your Windows desktop.
2. Select the drives, directories, or files that you want to scan.
3. Select the scan option to begin the virus check. If PC-cillin finds any infected files, it will list several options for you to follow.

▶ PC-Doctor

PC-Doctor contains comprehensive hardware diagnostics and system information tests that you can run to verify the functionality of your computer's hardware components. Components can be tested individually or together according to your preferences. If you suspect that you may have a hardware component failure, you will need to run this program prior to contacting your manufacturer for technical support.

You may also use this utility to check and obtain detailed information about your computer. This information will serve as reference and may help diagnose computer problems.

To run PC-Doctor, do either of the following:

- If you are running Windows:
 - a. Select the **PC-Doctor** icon from your Windows desktop.
 - b. Follow the directions on the screen.
- If you are running DOS:
 - a. Boot from the Programs CD.
 - b. Select the **PC-Doctor** option.
 - c. Follow the directions on the screen.

For more information about PC-Doctor, you may refer to the following Web site: www.ws.com

► BIOS utility

The BIOS utility is a hardware configuration program built into your computer's Basic Input/Output System (BIOS). Since most computers are already properly configured and optimized, there is no need to run this utility. However, if you encounter configuration problems and get the "Run Setup" message, you will need to run this utility.



Note: Before you run BIOS, make sure that you have saved all open files. The computer reboots immediately after you exit Setup.

To run the BIOS utility, press the key combination **Ctrl+Alt+Esc**. For information about BIOS and how to configure your computer, refer to the Veriton 9100 online manual (see "Accessing the online manual" on page 6).

► Reinstalling programs

If you uninstall one of the preinstalled programs and want to reinstall it, do the following:

1. Make sure the computer is turned on.
2. Insert the Resource CD into the CD-ROM drive.
3. Select the application that you want to reinstall.
4. Follow all onscreen instructions until you finish the installation.

6 Q & A



This chapter tells you what to do in case your computer is not working properly. However, if a more serious problem arises, contact your dealer or the technical support center for assistance.

The following questions are possible situations that may arise during the use of your computer and each is followed by easy answers and solutions to the situation.

Q: I pressed on the power switch but the system did not boot up.

A: Check the LED located at the center of the power switch.

If the LED is not lit, no power is being applied to the system. Do any of the following:

- Check if you plugged the power cable properly into an electrical outlet.
- Check if the main power switch on the rear panel of your computer is switched to “ON” (1). See “Turning on your computer” on page 31 for the location of the main power switch on your computer.
- If you are using a power strip or AVR, make sure that it is plugged in and turned on.

If the LED is lit, check the following:

- Is a nonbootable (nonsystem) diskette in the floppy drive? If yes, remove or replace it with a system diskette and press **Ctrl + Alt + Del** to restart your computer.
- The operating system files may be damaged or missing. Insert the startup disk you created during Windows setup into the floppy disk drive and press **Ctrl + Alt + Del** to restart your computer. This will automatically diagnose your system and make necessary fixes.

Q: Nothing appears on the screen.

A: Your computer’s power management function automatically blanks the screen to save power. Just press any key to turn the display back on.

If pressing a key does not work, contact your dealer or the technical support center for support.

Q: The printer does not work.

A: Do the following:

- Make sure that the printer is connected to a power outlet and that it is turned on.
- Make sure that the printer cable is connected securely to the system's parallel port and the corresponding port on the printer. See "Printer" on page 33 for information on how to connect the printer to your computer.
- For additional information concerning the printer, refer to the printer's documentation.

Q: No sound comes out from the computer.

A: Check the following:

- The volume may be muted. Under Windows, look for the Volume icon on the taskbar. If it is crossed-out, click on the icon and deselect the **Mute** option.
- If headphones, earphones, or external speakers are connected to the line-out jack of your computer, the internal or built-in speakers are automatically turned off.

Q: System cannot read diskette, hard disk, and/or CD information.

A: Check the following:

- Make sure that you are using the correct type of disc or diskettes. See “Disk drives” on page 19.
- Check if the diskette is formatted correctly. If not, format it again.



.....
Caution: If you reformat a diskette, you will lose all data on it.

- Make sure the diskette or CD is inserted into the drive correctly.
- Check if the CD is clean and not scratched.
- Check your drive by using a good (i.e., undamaged) diskette or a good CD. If your floppy disk drive or CD-ROM drive can not read the information on the good diskette or CD there may be a problem with the drive. Contact your dealer or technical support center for help.

Q: System cannot write diskette and/or hard disk information.

A: Check the following:

- Make sure the diskette or hard disk is not write-protected. See “Disk drives” on page 19.
- Make sure that you are using the correct type of disc or diskette. See “Disk drives” on page 19.
- Check if the diskette is formatted correctly. If not, format it again.



.....
Caution: If you reformat a diskette, you will lose all data on it.

Index

A

applications 61

C

computer maintenance 4
 cleaning 4
 servicing 4
 connecting options
 external monitor 29
 multimedia devices 36
 joystick 36
 microphone 36
 speakers 36
 network 33, 34
 printer 33

D

disk drives 19
 CD-ROM drive 19
 CD-ROM/DVD-ROM drive
 inserting 20
 taking care CDs/DVDs 21
 floppy drive 19
 not write-protect 19
 write-protect 19
 hard disk drive 21

F

features 9
 connectivity 9
 multimedia 9
 performance 9
 front panel 10

I

internal components 46

K

keyboard 14
 cursor keys 16
 lock keys 16
 windows-keys 17

M

mouse 18
 buttons 18
 clicking 18
 double-click 18
 ratchet wheel 18

Q

Q&A 69
 blank screen 69
 no audio 70
 no sound 70
 printer not working 69
 system cannot read disk 71
 system cannot write to disk 71
 system did not boot up 69

R

rear panel 12

S

setting up computer 25, 27
 area 25
 chair 25
 keyboard 26, 27
 monitor 26
 mouse 26, 28
 power cable 29
 software 61
 anti-virus 62
 PC-cillin 62
 PC-Doctor 63
 reinstalling procedure 22, 64,
 65
 system boards 52
 audio board 55
 mainboard 52

T

turning off computer 32
 software shutdown 32
 suspend mode 32
 turning on computer 31
 power button 31

U

upgrade
 add memory 56
 computer 52, 56

installation precautions 41
 ESD 41
 post-installation 42
 preinstallation 41

open computer 43
replace components 52, 56
replace cover 44