

Veriton 7200

User's guide

Copyright © 2001 Acer Incorporated
All Rights Reserved.

Veriton 7200
User's guide

Changes may be made periodically to the information in this publication without obligation to notify any person of such revision or changes. Such changes will be incorporated in new editions of this manual or supplementary documents and publications. This company makes no representations or warranties, either expressed or implied, with respect to the contents hereof and specifically disclaims the implied warranties of merchantability or fitness for a particular purpose.

Record the model number, serial number, purchase date, and place of purchase information in the space provided below. The serial number and model number are recorded on the label affixed to your computer. All correspondence concerning your unit should include the serial number, model number, and purchase information.

No part of this publication may be reproduced, stored in a retrieval system, or transmitted, in any form or by any means, electronic, mechanical, photocopy, recording, or otherwise, without the prior written permission of Acer Incorporated.

Model Number : _____

Serial Number: _____

Purchase Date: _____

Place of Purchase: _____

Acer and the Acer Logo are registered trademarks of Acer Inc. Other company's product names or trademarks are used herein for identification purposes only and belong to their respective companies.

Notices

FCC notice

This device has been tested and found to comply with the limits for a Class B digital device pursuant to Part 15 of the FCC Rules. These limits are designed to provide reasonable protection against harmful interference in a residential installation. This device generates, uses, and can radiate radio frequency energy and, if not installed and used in accordance with the instructions, may cause harmful interference to radio communications.

However, there is no guarantee that interference will not occur in a particular installation. If this device does cause harmful interference to radio or television reception, which can be determined by turning the device off and on, the user is encouraged to try to correct the interference by one or more of the following measures:

- Reorient or relocate the receiving antenna
- Increase the separation between the device and receiver
- Connect the device into an outlet on a circuit different from that to which the receiver is connected
- Consult the dealer or an experienced radio/television technician for help

Notice: Shielded cables

All connections to other computing devices must be made using shielded cables to maintain compliance with FCC regulations.

Notice: Peripheral devices

Only peripherals (input/output devices, terminals, printers, etc.) certified to comply with the Class B limits may be attached to this equipment. Operation with noncertified peripherals is likely to result in interference to radio and TV reception.



.....

Caution! Changes or modifications not expressly approved by the manufacturer could void the user's authority, which is granted by the Federal Communications Commission, to operate this computer.

Use conditions

This part complies with Part 15 of the FCC Rules. Operation is subject to the following two conditions: (1) this device may not cause harmful interference, and (2) this device must accept any interference received, including interference that may cause undesired operation.

Notice: Canadian users

This Class B digital apparatus meets all requirements of the Canadian Interference-Causing Equipment Regulations.

Remarque à l'intention des utilisateurs canadiens

Cet appareil numérique de la classe B respecte toutes les exigences du Règlement sur le matériel brouilleur du Canada.

Important safety instructions

Read these instructions carefully. Save these instructions for future reference.

1. Follow all warnings and instructions marked on the product.
2. Unplug this product from the wall outlet before cleaning. Do not use liquid cleaners or aerosol cleaners. Use a damp cloth for cleaning.
3. Do not use this product near water.
4. Do not place this product on an unstable cart, stand, or table. The product may fall, causing serious damage to the product.
5. Slots and openings in the cabinet and the back or bottom are provided for ventilation; to ensure reliable operation of the product and to protect it from overheating, these openings must not be blocked or covered. The openings should never be blocked by placing the product on a bed, sofa, rug, or other similar surface. This product should never be placed near or over a radiator or heat register, or in a built-in installation unless proper ventilation is provided.
6. This product should be operated from the type of power indicated on the marking label. If you are not sure of the type of power available, consult your dealer or local power company.
7. Do not allow anything to rest on the power cord. Do not locate this product where persons will walk on the cord.

8. If an extension cord is used with this product, make sure that the total ampere rating of the equipment plugged into the extension cord does not exceed the extension cord ampere rating. Also, make sure that the total rating of all products plugged into the wall outlet does not exceed the fuse rating.
9. Never push objects of any kind into this product through cabinet slots as they may touch dangerous voltage points or short out parts that could result in a fire or electric shock. Never spill liquid of any kind on the product.
10. Do not attempt to service this product yourself, as opening or removing covers may expose you to dangerous voltage points or other risks. Refer all servicing to qualified service personnel.
11. Unplug this product from the wall outlet and refer servicing to qualified service personnel under the following conditions:
 - a. When the power cord or plug is damaged or frayed
 - b. If liquid has been spilled into the product
 - c. If the product has been exposed to rain or water
 - d. If the product does not operate normally when the operating instructions are followed. Adjust only those controls that are covered by the operating instructions since improper adjustment of other controls may result in damage and will often require extensive work by a qualified technician to restore the product to normal condition.
 - e. If the product has been dropped or the cabinet has been damaged
 - f. If the product exhibits a distinct change in performance, indicating a need for service.
12. Replace the battery with the same type as the product's battery we recommend. Use of another battery may present a risk of fire or explosion. Refer battery replacement to a qualified serviceman.
13. **Warning!** Batteries may explode if not handled properly. Do not disassemble or dispose of them in fire. Keep them away from children and dispose of used batteries promptly.
14. Use only the proper type of power supply cord set (provided in your accessories box) for this unit. It should be a detachable type: UL listed/CSA certified, type SVT, rated 7A 125V minimum, VDE approved or its equivalent. Maximum length is 15 feet (4.6 meters).

Laser compliance statement

The CD or DVD drive in this computer is a laser product. The CD or DVD drive's classification label (shown below) is located on the drive.

CLASS 1 LASER PRODUCT

CAUTION: INVISIBLE LASER RADIATION WHEN OPEN. AVOID EXPOSURE TO BEAM.

APPAREIL A LASER DE CLASSE 1 PRODUIT

LASERATTENTION: RADIATION DU FAISCEAU LASER INVISIBLE EN CAS D'OUVERTURE. EVITER TOUTE EXPOSITION AUX RAYONS.

LASER KLASSE 1

VORSICHT: UNSICHTBARE LASERSTRAHLUNG, WENN ABDECKUNG GEÖFFNET, NICHT DEM STRAHL AUSSETZEN

PRODUCTO LÁSER DE LA CLASE I

ADVERTENCIA: RADIACIÓN LÁSER INVISIBLE AL SER ABIERTO. EVITE EXPONERSE A LOS RAYOS.

ADVARSEL: LASERSTRÅLING VEDÅBNING SE IKKE IND I STRÅLEN

VARO! LAVATTAESSA OLET ALTTINA LASERSÄTEILYLLE.

WARNING: LASERSTRÅLNING NÅR DENNA DEL ÅR ÖPPNAD ÅLÅ TUIJOTA SÄTEESEENSTIRRA EJ IN I STRÅLEN

WARNING: LASERSTRÅLNING NAR DENNA DEL ÅR ÖPPNADSTIRRA EJ IN I STRÅLEN

ADVARSEL: LASERSTRÅLING NAR DEKSEL ÅPNESSTIRR IKKE INN I STRÅLEN

Lithium battery statement

CAUTION

Danger of explosion if battery is incorrectly replaced. Replace only with the same or equivalent type recommended by the manufacturer. Discard used batteries according to the manufacturer's instructions.

ADVARSEL!

Lithiumbatteri - Eksplosionsfare ved fejlagtig håndtering. Udskiftning må kun ske med batteri af samme fabrikat og type. Léver det brugte batteri tilbage til leverandøren.

ADVARSEL

Ekspløsjonsfare ved feilaktig skifte av batteri. Benytt samme batteritype eller en tilsvarende type anbefalt av apparatfabrikanten. Brukte batterier kasseres i henhold til fabrikantens instruksjoner.

VARNING

Explosionsfara vid felaktigt batteribyte. Använd samma batterityp eller en ekvivalent typ som rekommenderas av apparattillverkaren. Kassera använt batteri enligt fabrikantens instruktion.

VAROITUS

Päristö voi räjähtää, jos se on virheellisesti asennettu. Vaihda paristo ainoastaan laitevalmistajan suosittelemaan tyyppiin. Hävitä käytetty paristo valmistajan ohjeiden mukaisesti.

VORSICHT!

Explosionsgefahr bei unsachgemäßen Austausch der Batterie Ersatz nur durch denselben oder einem vom Hersteller empfohlenem ähnlichen Typ. Entsorgung gebrauchter Batterien nach Angaben des Herstellers.

Year 2000 compliance statement

The Veriton 7200 computer carries the "Hardware NSTL Tested Year 2000 Compliant" logo, which certifies that this model has been tested by NSTL using the YMark2000 test, and has been found to meet NSTL's standards for Year 2000 hardware compliance.



For more details, check the Acer Year 2000 Resource Center at <http://global.acer.com/service/pcy2000.html>

Contents

Notices	iii
1 First things first	1
Package contents	3
Taking care of your computer	4
Important tips	4
Cleaning and servicing	4
Asking for technical assistance	5
Accessing the online guide	6
2 System tour	7
Features	9
Performance	9
Multimedia	9
Connectivity	9
Front panel	10
Rear panel	12
Keyboard	14
Mouse	17
Disk drives	18
Floppy drive	18
CD-ROM/DVD-ROM/CD-RW drive	19
Hard disk	20
3 Setting up your computer	21
Arranging a comfortable work area	23
Adjusting your chair	23
Positioning your Veriton PC	23
Positioning your monitor	24
Positioning your keyboard	24
Positioning your mouse	24
Connecting peripherals	25
USB Keyboard	25
USB Mouse	26
Monitor	27
Power cable	28
Turning on your computer	29
Turning off your computer	31
Connecting options	32
Printer	32
Serial mouse	33

Network	34
USB devices	35
Multimedia devices	37
4 Upgrading your computer	41
Installation precautions	43
ESD precautions	43
Preinstallation instructions	43
Post-installation instructions	44
Opening your computer	45
To remove the side panel	45
To reinstall the side panel	46
Internal components	48
Replacing the hard disk	49
Installing an expansion card	51
System boards	53
Mainboard layout	53
Audio board	56
Installing additional memory	57
To install a DIMM	58
To reconfigure your computer	58
5 Software	59
Acrobat Reader	62
LDCM	63
Norton AntiVirus	64
NTI CD-Maker 2000 (for models with CD-RW)	65
PowerDVD (for models with DVD)	66
VariSpeed (Windows Me only)	67
BIOS utility	68
Reinstalling programs	69
6 Q & A	71
Index	77

1 First things first

This chapter describes the contents of your computer package and also provides important tips on how to take care of your computer.

Package contents

Before you unpack your computer, make sure that you have enough space to set up your computer.

Carefully unpack the carton and remove the contents. If any of the following items are missing or damaged, contact your dealer immediately:

- Veriton 7200
- Items contained in the accessory box
 - USB keyboard
 - USB mouse
- User's guide and installation poster
- Other user documentation and third-party software

Taking care of your computer

Please read the important instructions listed in this section. Following these instructions will help you maximize the durability of your computer.

Important tips

- Do not expose the computer to direct sunlight. Do not place it near sources of heat, such as a radiator.
- Do not subject the computer to magnetic fields.
- Do not expose the computer to rain or moisture.
- Do not spill water on the computer.
- Do not subject the computer to heavy shock or vibration.
- Do not expose the computer to dust and dirt.
- Never place the system on uneven surfaces.
- Do not step on the power cord or place heavy objects on top of it. Carefully route the power cord and any cables away from personal traffic.
- When unplugging the power cord, do not pull on the cord itself but pull on the plug.
- The total ampere rating of the equipment plugged in should not exceed the ampere rating of the cord if you are using an extension cord. Also, the total current rating of all equipment plugged into a single wall outlet should not exceed the fuse rating.
- Check the documentation that came with your software programs to see if you can select other combinations of resolution and color. These adjustments could make viewing the screen more comfortable.

Cleaning and servicing

To clean your computer and keyboard

1. Turn off the computer and unplug the power cord.
2. Use a soft cloth moistened with water and gently wipe the exterior of the computer and the keyboard. Do not use liquid or aerosol cleaners.

To clean your mouse

1. Open the circular cover underneath the mouse.
2. Take out the rubber ball and wipe it with a soft, damp cloth.
3. Put the ball back and close the cover.

To clean your monitor

Make sure that you keep your screen clean. For cleaning instructions, refer to the documentation that came with your monitor.

When to contact a service technician

- If you dropped and damaged the computer.
- If liquid has been spilled into the computer.
- If the computer is not operating normally.

Asking for technical assistance

For technical assistance, contact your local dealer or distributor. You may also access the Acer Web site (www.acer.com) for information on how and where to contact the service centers available in your area.

Accessing the online guide

You may also refer to the Veriton 7200 online guide for information about your computer. To access the online guide, simply double-click on the Veriton 7200 Online icon on your Windows desktop.

2 System tour

This chapter discusses the features and components of your computer.

Features

Here are just a few of your computer's many features:

Performance

- Intel Pentium® 4 processor with Intel NetBurst™ micro-architecture
- System memory expandable to a maximum of 3 GB
- Power management function
- 3.5-inch floppy drive
- DVD-ROM, CD-ROM or CD-RW drive
- High-capacity, Enhanced-IDE hard disk

Multimedia

- 128-bit graphics accelerator installed in the AGP Pro card slot
- 3-D quality audio system via onboard audio controller
- Audio-in/Line-in, Audio-out/Line-out, Headphone-out, Mic-in, and Game/MIDI interfaces



Note: The system has two microphone-in ports (front and rear). However, you can not use both of them at the same time. The default setting for your system enables the microphone-in port in front and disables the one at the back.





Connectivity

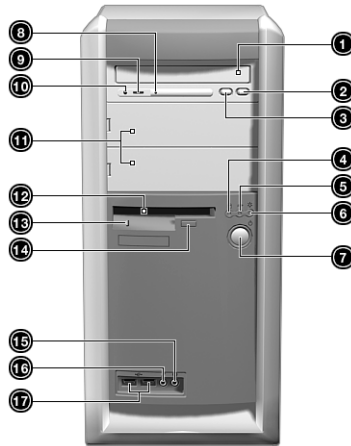

- PS/2 mouse and keyboard interfaces
- Two serial and one parallel interfaces
- Universal Serial Bus (USB) ports (two on the front and two on the rear panel)
- High-speed fax/data PCI modem (optional)
- 10Base-T/100Base-TX network support with remote wake-up function

Front panel

Your computer's front panel consists of the following:



Label	Icon	Component
1		CD-ROM/DVD-ROM/CD-RW tray
2		Stop/Eject button
3		Skip/Forward button
4		Hard disk activity light-emitting diode (LED)
5		LAN activity LED
6		Power LED
7		Power switch
8		CD-ROM/DVD-ROM/CD-RW LED
9		Volume control tuner

Label	Icon	Component
10		CD-ROM/DVD-ROM/CD-RW Headphone/ Earphone port
11		5.25-inch drive bays
12		3.5-inch floppy drive
13		Floppy drive LED
14		Floppy drive eject button
15		Speaker-out/Line-out port
16		Microphone-in port (front) ^{see note}
17		USB ports









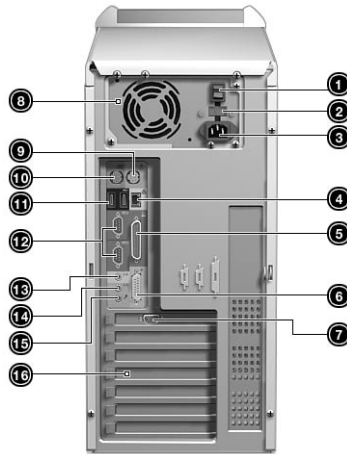



Note: The system has two microphone-in ports (front and rear). However, you can not use both of them at the same time. The default setting for your system enables the microphone-in port in front and disables the one at the back.

Rear panel

Your computer's rear panel consists of the following:



Label	Icon	Color	Component
1			Power switch
2			Voltage selector switch
3			Power cord socket
4		White	Network port
5		Burgundy	Parallel/Printer port
6		Gold	Game/MIDI port
7			CRT/LCD monitor port
8			Power supply
9		Green	PS/2 mouse port

Label	Icon	Color	Component
10		Purple	PS/2 keyboard port
11		Black	USB ports
12		Teal or Turquoise	Serial port
13		Lime	Audio-out/Line-out jack
14		Light blue	Audio-in/Line-in jack
15			Microphone-in port (rear)
16			Expansion slots



For information on how to connect the peripherals, see “Connecting peripherals” on page 25 and “Connecting options” on page 32.



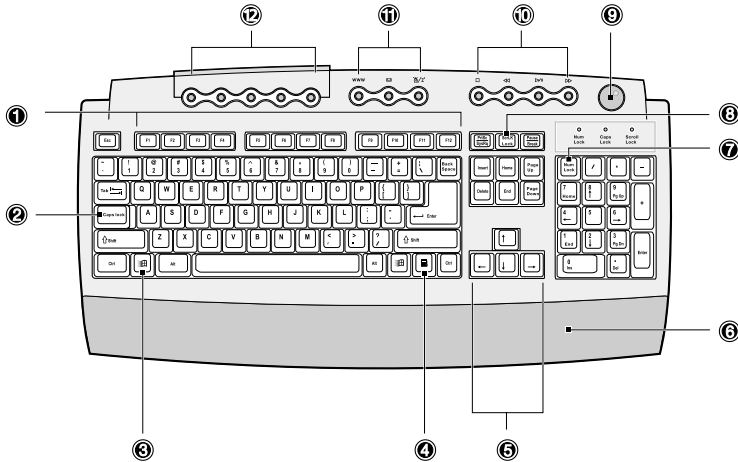



Keyboard

The keyboard has full-sized keys that include separate cursor keys, two Windows keys, and twelve function keys.



Item	Component	Description
1	Function keys	Performs specific functions, depending on the application that uses them.
2	Caps lock	When activated, all alphabetic characters typed appear in uppercase (same function as pressing Shift + <letter>).

Item	Component	Description
3	Windows logo key 	Start button. Combinations with this key perform special functions, such as: <ul style="list-style-type: none"> • Windows + Tab: Activate the next Taskbar button • Windows + E: Explore My Computer • Windows + F: Find Document • Windows + M: Minimize All • Shift + Windows + M: Undo Minimize All • Windows + R: Display Run dialog box
4	Application key 	Opens the applications context menu (same function as clicking the right button of the mouse).
5	Cursor keys	Also called arrow keys, let you move the cursor around the screen. They serve the same function as the arrow keys on the numeric pad when the Num lock is toggled off.
6	Palm rest (detachable)	Provides a comfortable place to rest your hands while typing.
7	Num lock	When activated, the keypad is set to numeric mode, i.e., the keys function as a calculator (complete with arithmetic operators such as +, -, * and /).
8	Scroll lock	When activated, the screen moves one line up or down when you press the up arrow or down arrow respectively. Take note that Scroll Lock may not work with some applications.
9	Volume control/Mute 	Controls the speaker volume. Turn it clockwise or counterclockwise to adjust the volume. Press it to toggle between mute and sound.

Item	Component	Description
10	Multimedia keys	<p>Allow you to do the following:</p> <ul style="list-style-type: none"> • Play/Pause button  : press to start playing the audio track or video file. Press again to pause. • Stop button  : press to stop playing the audio track or video file. • Forward button  : press to skip forward to the next track or video file and start playing. • Backward button  : press to skip backward to the previous track or video file and start playing.
11	Internet/Suspend keys	<p>Consist of three buttons:</p> <ul style="list-style-type: none"> • Email button  : launches the email application that came bundled with your system. • Web browser button  : launches the browser application that came bundled with your system. • Suspend/Resume button  : puts the system to sleep when pressed. To wake up the system, press it again.
12	Programmable keys	<p>Help you directly access a URL (Web site) or launch any program, file, or application in your system. The fifth key is set to launch the media player.</p> <p>To configure the settings of each key, right-click on the Magic Keyboard icon located on the Windows taskbar.</p>

Mouse

Your mouse has one ratchet wheel and two buttons: a left button and a right button. Quickly pressing and releasing the buttons is called clicking. Sometimes, you will need to do a double-click (clicking the same button twice quickly) or a right-click (clicking the right button quickly).

The ratchet wheel in between the two buttons is added to provide easier scrolling capability. By simply moving the wheel with your index finger, you can quickly move through multiple pages, lines, or windows. The wheel may also function as a third button allowing you to quickly click or double-click an icon or a selected item.

For information on how to clean your mouse, see “To clean your mouse” on page 5.



.....
Note: If you are left-handed, refer to your Windows manual for instructions on how to set up your mouse for left-handed use.

Disk drives

Your computer comes with the following disk drives:

Floppy drive

Your computer's 3.5-inch floppy drive can handle 720-KB and 1.44-MB capacity diskettes.

The floppy diskettes are compact, lightweight, and easy to carry around. Here are some tips on how to take care of your diskettes:

- Always make backup copies of the diskettes that contain important data or program files.
- Keep diskettes away from magnetic fields and sources of heat.
- Avoid removing a diskette from a drive when the floppy drive activity light is on.
- Write-protect your diskettes to prevent accidental erasure. To do this, slide the write-protect tab to the write-protect position.

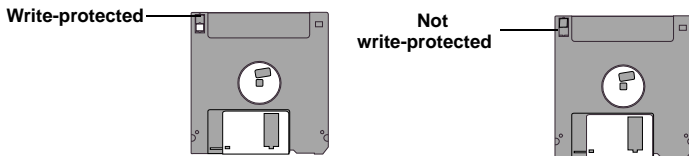

- When you put a label on a 3.5-inch diskette, make sure that the label is properly attached (flat on the surface) and within the labeling area (area with a slight surface depression) on the diskette. An improperly attached label may cause a diskette to get stuck in a drive when you are inserting or removing it.

CD-ROM/DVD-ROM/CD-RW drive

Your computer may come with a CD-ROM, DVD-ROM or a CD-RW drive. This drive is located on the front panel of your computer. The CD-ROM drive allows you to play different types of compact discs (CDs). The DVD-ROM drive allows you to play not only old CD-ROMs, CD-I discs, and video CDs, but new digital video discs (DVDs) as well. The CD-RW drive allows you to record or burn CD-RW (recordable and rewritable) discs. DVD or DVD-ROM is a new type of disc media that holds a minimum of 4.7-GB (gigabytes), enough for a full-length movie. It is believed that it will eventually replace CD-ROMs, as well as VHS video cassettes and laser discs.

CDs and DVDs, like diskettes, are also compact, lightweight, and easy to carry around. However, they are more delicate than diskettes and must be handled with extra care.

To insert a CD or DVD into your computer's CD-ROM or DVD drive:

1. Gently push the eject button located on the front panel.



2. When the disc tray slides open, insert the CD or DVD. Make sure that the label or title side of the disc is facing upward. When holding a disc, hold it by the edges to avoid leaving smudges or fingerprints.



3. Push the eject button again to close the tray.

To take care of your CDs and DVDs

- Keep your disc in its case when not in use to avoid scratches or other damage. Any kind of dirt or damage can affect the data on the disc, impair the disc lens reader on the CD or DVD drive, or stop the computer from successfully reading the disc.
- When handling discs, always hold them by the edges to avoid smudges or fingerprints.
- When cleaning discs, use a clean, dust-free cloth and wipe in a straight line from the center to the edge. Do not wipe in a circular motion.
- Clean your CD or DVD drive periodically. You may refer to the Cleaning kit for instructions. Cleaning kits can be purchased in any computer or electronics shop.

Hard disk

Your computer is preinstalled with a high-capacity Enhanced-IDE (E-IDE) hard disk. If you want to replace your hard disk or upgrade it, contact your dealer or a qualified service technician for support.

3 Setting up your computer

This chapter contains step-by-step instructions on how to set up your computer and connect additional peripherals.

Arranging a comfortable work area

Working safely begins with the arrangement of your work space and the proper use of equipment. For this reason, it is very important to take time and think about how you are going to arrange your work area.

Here are some points to consider:

Adjusting your chair

Having the right kind of chair does not necessarily mean that you'll be properly supported. It is necessary to adjust your chair to fit your body. Proper body posture will make you more comfortable and productive.

- Avoid tilting your chair. If you have a chair that tilts, lock the tilt knobs so that your chair will not tilt forward or backward while you are using your computer.
- Adjust your chair height in such a way that you can sit on it with your thighs parallel to the floor and your feet resting flat on the floor.
- Rest your body on the chair back. Your torso works harder to maintain balance if you do not rest your body on the chair back.

Positioning your Veriton PC

Take note of the following when selecting a location for your computer:

- Do not put your computer near any equipment that might cause electromagnetic or radio frequency interference such as radio transmitters, televisions, copy machines, or heating and air-conditioning equipment.
- Avoid dusty areas and extremes of temperature and humidity.
- You may place your computer beside your desk or under your table, as long as it does not block the space that you need for working and moving.

Positioning your monitor

Place your monitor at a comfortable viewing distance, usually 50 to 60 centimeters away. Adjust the display in such a way that the top of the screen is at or slightly below eye level.

Positioning your keyboard

The location of the keyboard is a very important factor to your posture. Placing it too far away will make your body lean forward forcing you to sit in an unnatural position. Placing it too high will add tension to your shoulder muscles.

- The keyboard should be placed just above your lap. Adjust the keyboard height by flipping the folding stands located under the keyboard.
- Keep your lower arms parallel to the floor as you type. Your upper arms and shoulders should be relaxed. Then try typing with a light touch. If you feel any shoulder or neck strain, stop for a while and check your posture.
- Position your keyboard in front of your monitor. Putting your keyboard beside your monitor will make you turn your head while you type which could add tension to your neck muscles that may later result in neck strain.

Positioning your mouse

- The mouse should be placed on the same surface as your keyboard so that you can reach it with ease.
- Adjust its position to allow enough space for movement without making you stretch or lean over.
- Use your arm to move the mouse. Do not rest your wrist on the table when moving the mouse.

Connecting peripherals

Setting up your computer is easy. For the most part, you only have four things to connect: the USB keyboard, the USB mouse, the monitor, and the power cable.

USB Keyboard

Plug the keyboard cable into the USB port  (black port) located on the front or rear panel of your computer.

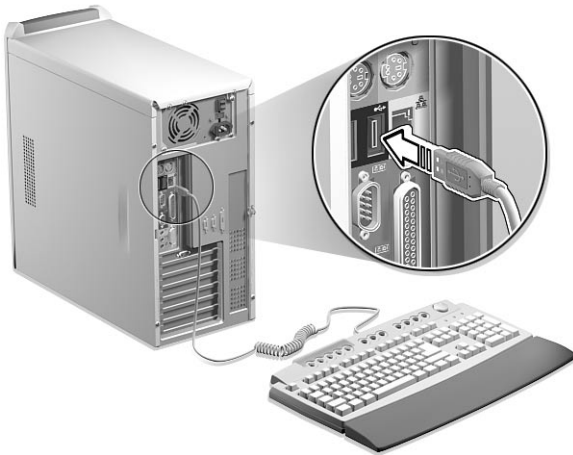

.....
Note: If you are using a PS/2 keyboard, plug the keyboard cable into the PS/2 keyboard port  (purple port) located on the rear panel of your computer.

USB Mouse

Plug the mouse cable into the USB port  (black port) located on the front or rear panel of your computer.

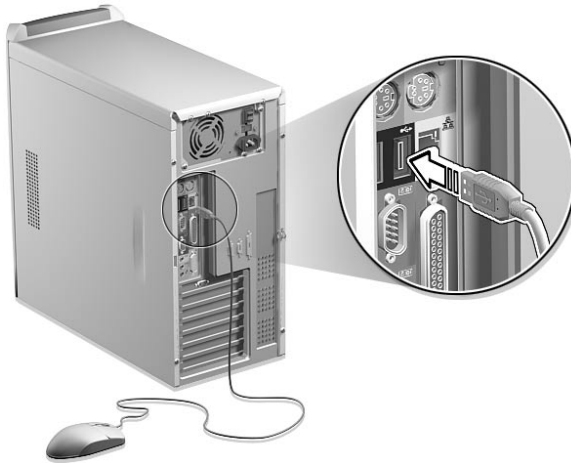



Note: If you are using a PS/2 mouse, plug the mouse cable into the PS/2 mouse port  (green port) located on the rear panel of your computer.

Monitor

To connect a monitor, simply plug the monitor cable into the monitor port located on the rear panel of your computer.

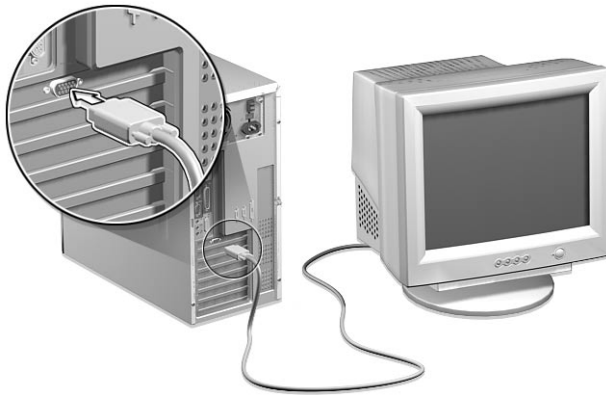

Note: Refer to the monitor manual for additional instructions and information.

Power cable



Caution: Before you proceed, check the voltage range in your area. Make sure that it matches your computer's voltage setting (refer to page 12 for the location of the voltage selector switch on the rear panel of your computer). If they don't match, change your computer's voltage setting according to your area's voltage range.

Plug the power cable into the power cable socket located on the rear panel of your computer. Then plug the other end of the power cable into a power outlet.



Turning on your computer

After connecting the necessary peripherals and plugging in the power cable, you are now ready to turn the computer on and get to work.

To turn on your computer:

1. Turn on all peripherals connected to your computer such as the monitor, printer, fax, speakers, etc.
2. On the rear panel of your computer, set the voltage selector switch to the voltage range applicable to your area (a) then turn on the power switch (b).



3. On the front panel of your computer, press the power button.



Important: Make sure that the power cable is properly plugged into an electrical outlet. If you are using a power strip or an AVR (Auto-Voltage Regulator), make sure that it is plugged in and turned on.

Turning off your computer

To turn off your computer, click on the **Start** button, highlight **Shut Down**, select **Shut down**; then click on **OK**. You can then turn off all peripherals connected to your computer.

If you cannot shut down your computer normally, press the power button for at least four seconds. Quickly pressing the button may put the computer in Suspend mode only.

Connecting options

Printer

To connect a printer, plug the printer cable into the parallel port (burgundy port) located on the rear panel of your computer. 

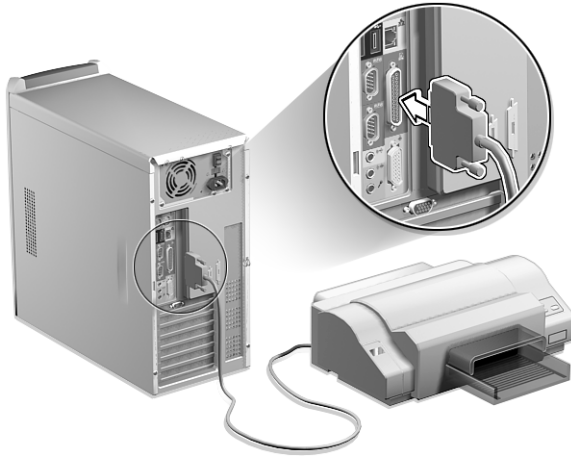

Serial mouse

To connect a serial mouse, plug the serial mouse cable into the serial port  (teal or turquoise port) located on the rear panel of your computer.

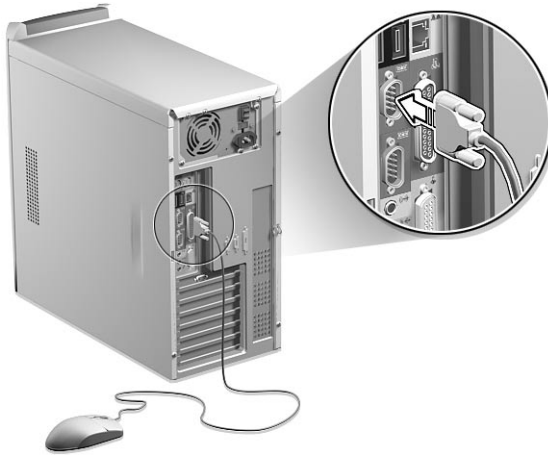

Network

You can connect your computer to a Local Area Network (LAN) using a network cable. To do so, simply plug the network cable into the network port  on the rear panel of your computer.



Note: Consult your operating system manual for information on how to configure your network setup.

USB devices

Universal Serial Bus (USB) is a new serial bus design that is capable of cascading low-/medium-speed peripherals (less than 12 Mbps) such as a keyboard, mouse, joystick, scanner, printer and modem. With USB, complex cable connections can be eliminated.

Your computer comes with four USB ports: two each on both the front and rear panels. These ports allow you to connect additional serial devices to your computer without using up its system resources.

To connect a USB device, simply plug the device cable into any of the USB ports  (black port).





Note: Most USB devices have a built-in USB port which allows you to connect or daisy-chain more USB devices.

Multimedia devices

You can connect multimedia devices such as microphone, headphone or earphone, external speakers, audio line-in device and a joystick (for games). These devices will allow you to take advantage of your computer's multimedia features.

Plug the devices in as follows:

- microphone: connects to the Mic-in jack  (pink jack) located on the front and rear panel of your computer.



.....

Note: The system has two microphone-in ports (front and rear). However, you can not use both of them at the same time. The default setting for your system enables the microphone-in port in front and disables the one at the back.



- earphones, headphones: connect to the Headphone-out jack  (lime jack) located on the front panel of your computer



.....

Note: To adjust the volume of the headphones, click on the Volume icon located on the taskbar at the bottom of your screen. When the volume control pops up, drag the Volume control lever to the desired level. You can also use the Volume control button on the keyboard.



- external USB speakers: connect to the Audio-out/Line-out jack (🔊) (lime jack) and USB port (🔌) (black port) located on the rear panel of your computer.

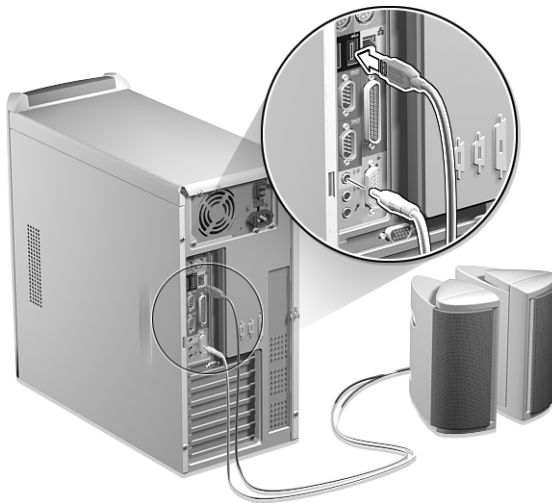

- audio line-in device: connects to the Audio-in/Line-in jack (🔊) (light blue jack) located on the rear panel of your computer

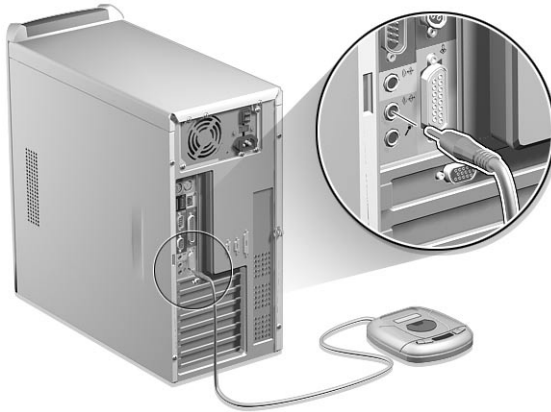

- joystick: connects to the Game/MIDI port (🎮) (gold port) located on the rear panel of your computer

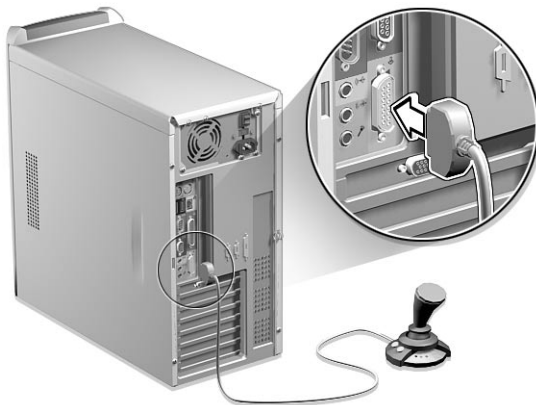

Note: For information on how to configure multimedia devices, consult the documentation that came with each device.

4 Upgrading your computer

This chapter contains instructions on how to upgrade your computer and basic information about your system boards that you will find helpful when performing the upgrade process.

Installation precautions

Before you install any computer component, we recommend that you read the following sections. These sections contain important ESD precautions along with preinstallation and post-installation instructions.

ESD precautions

Electrostatic discharge (ESD) can damage your processor, disk drives, expansion boards, and other components. Always observe the following precautions before you install a computer component:

1. Do not remove a component from its protective packaging until you are ready to install it.
2. Wear a wrist grounding strap and attach it to a metal part of the computer before handling components. If a wrist strap is not available, maintain contact with the computer throughout any procedure requiring ESD protection.

Preinstallation instructions

Always observe the following before you install any component:

1. Turn off your computer and all the peripherals connected to it before opening it. Then unplug all cables from the power outlets.
2. Open your computer according to the instructions on page 45.
3. Follow the ESD precautions described above before handling a computer component.
4. Remove any expansion boards or peripherals that block access to the DIMM sockets or component connector.
5. See the following sections for specific instructions on the component you wish to install.



.....
Warning! Not turning off the computer properly before you start installing the components may cause serious damage.

Do not attempt the procedures described in the following sections unless you are a qualified service technician.

Post-installation instructions

Observe the following after installing a computer component:

1. See to it that the components are installed according to the step-by-step instructions in their respective sections.
2. Replace any expansion boards or peripherals that you removed earlier.
3. Replace the computer cover.
4. Connect the necessary cables and turn on your computer.

Opening your computer



Caution: Before you proceed, make sure that you have turned off your computer and all peripherals connected to it. Read the "Preinstallation instructions" on page 43.

You need to open your computer before you can install additional components. See the following section for instructions.

To remove the side panel

1. Turn off your computer and unplug all cables.
2. Place your computer on a flat, steady surface.
3. Remove the four screws from the rear panel using a screwdriver. Set the screws aside.

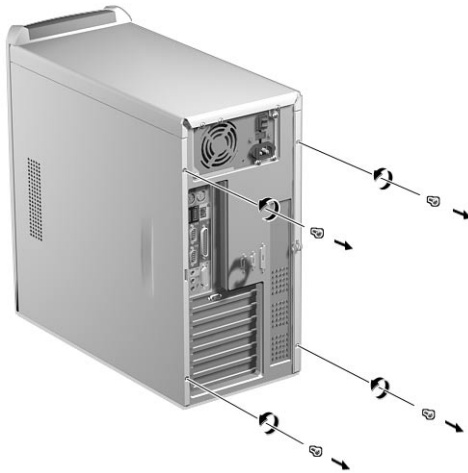

4. Hold one side panel with both hands. Slide it back about an inch and then gently pull it outward to detach it. Do the same to the other side.

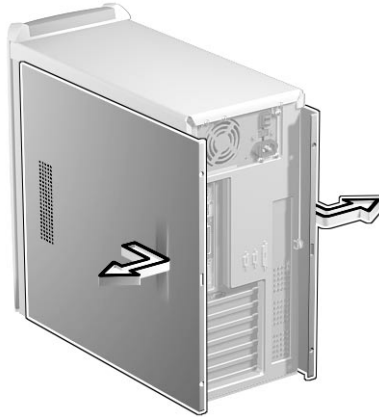

To reinstall the side panel

1. Align the side panel's hinges to the housing frame and then push it in to slide it back into place. Do the same to the other side.

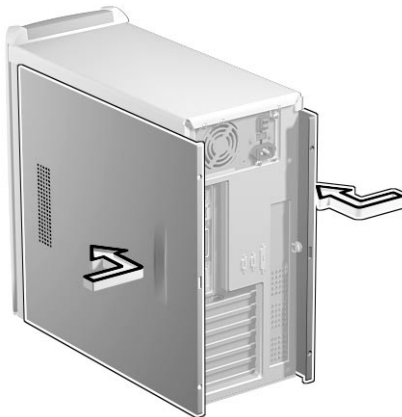

2. Secure the side panels with four screws.



Internal components

The figure below shows what your computer looks like once you remove the cover:

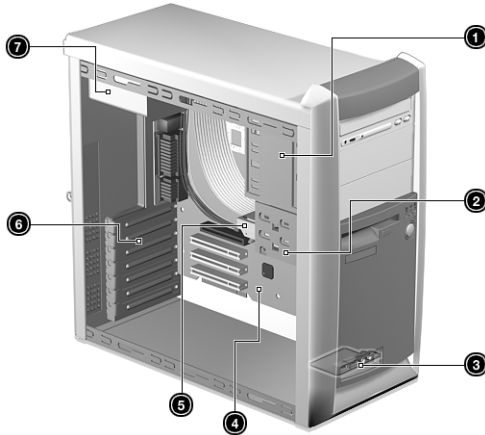

No.	Component
1	5.25-inch drive bays (three bays)
2	3.5-inch drive bays (two bays)
3	Daughterboard
4	Mainboard
5	Hard disk
6	Expansion slots
7	Power supply

Replacing the hard disk

Follow these steps to replace your computer's hard disk:

1. Remove the side panel (see page 45).
2. Remove the four screws that hold the hard disk to the disk frame. Set the screws aside.

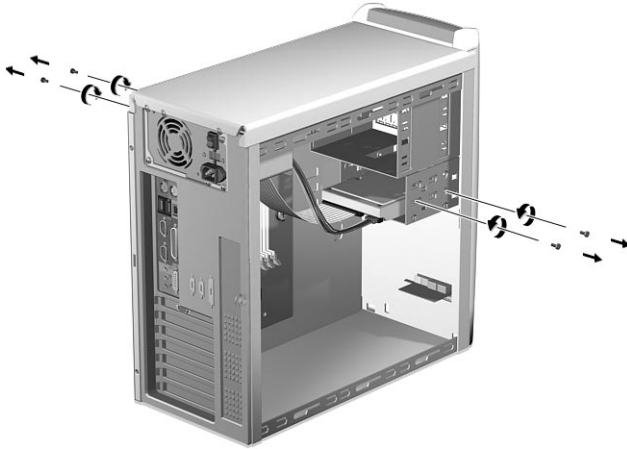

3. (a) Detach the power and hard disk cables from the hard disk.
(b) Detach the hard disk from the drive frame.

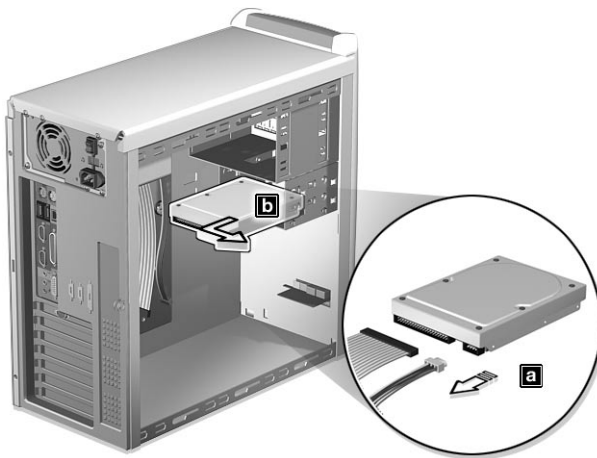

4. (a) Insert the new hard disk into the frame.
(b) Connect the power and hard disk cables to the new hard disk.

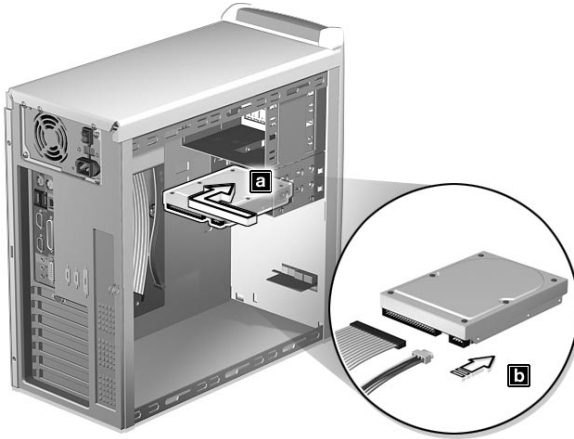

5. Secure it with four screws.



Note: Make sure that the other ends of the disk cables are securely connected to their corresponding connectors on the mainboard.

6. Reinstall the side panel (see page 46).

Installing an expansion card



.....
Note: Observe the "Installation precautions" on page 43 when installing or removing a computer component.

To install an expansion card:

1. Remove the side panel (see page 45).
2. Locate an empty PCI slot on the mainboard.
3. Remove the screw that holds the bracket to the computer. Save the screw.
4. Pull out the bracket on the housing opposite the selected empty slot.



5. Remove the expansion card from its protective packaging.
6. Align the card with the empty bracket and then insert it into the slot. Make sure that the card is properly seated.

7. Secure the card to your computer with a screw.



8. Reinstall the side panel (see page 46).

When you turn on the computer, BIOS (Basic Input/Output System) automatically detects and assigns resources to the newly-installed devices.

System boards

Mainboard layout

The mainboard becomes accessible once you open your computer. It should look like the figure shown below:

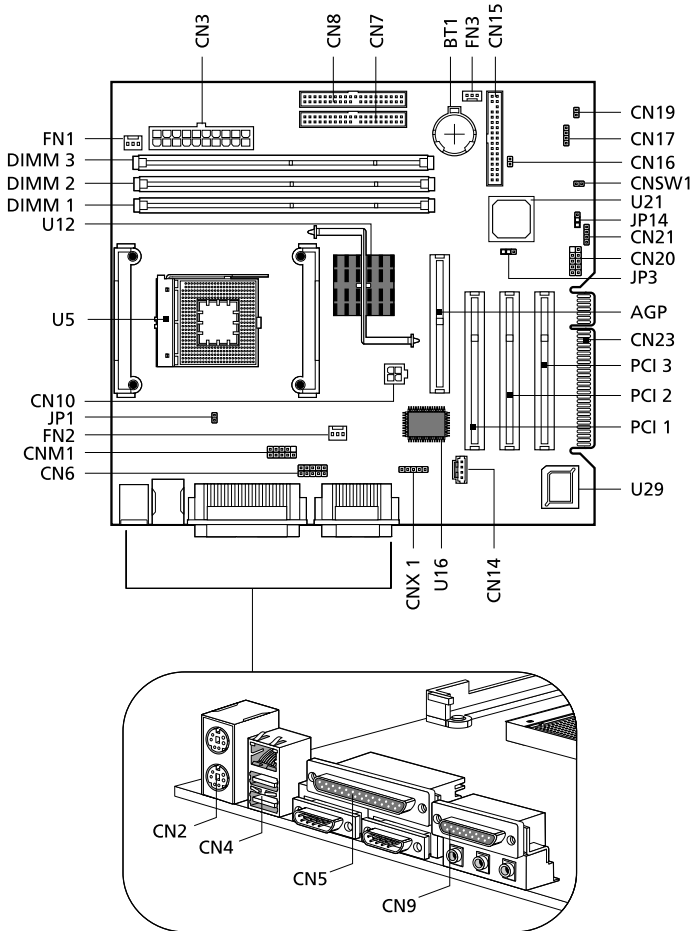

Label	Component
AGP	AGP slot
BT1	Battery
CN2	PS/2 mouse (upper) and keyboard (lower) ports
CN3	Power connector
CN4	Network (upper) and USB (lower) ports
CN5	Serial port (lower right and left) and parallel port (upper)
CN6	Memory stick connector
CN7	IDE 2 connector
CN8	IDE 1 connector
CN9	MIDI/game (upper), line-out (left), line-in (middle), and rear mic-in (right) ports
CN10	Power connector (12 V power)
CN14	CD-in connector
CN15	FDD Connector
CN16	Intrusion connector
CN17	HDD LED connector
CN19	Power button
CN20	Front USB connector
CN21	Power/Suspend LED connector
CN23	EXT PCI slot
CNM1	SmartCard (COM 2) connector ¹
CNSW1	IDE cold-swap connector
CNX1	Audio FPIO connector
DIMM 1-3	DIMM sockets 1-3

Label	Component
FN1	3-pin CPU fan connector
FN2	3-pin system fan connector
FN3	3-pin system fan connector
JP1	LAN active LED connector
JP3	Model select
JP14	1-2 Clear CMOS 2-3 Normal ²
PCI1 to 3	PCI slots 1 to 3
U5	CPU socket
U12	Intel 845 chipset
U16	SMSC chipset
U21	Intel ICH2 chipset
U29	BIOS chipset

¹ Share connection with serial port 2 (COM 2)

² Default value

Audio board

The audio board that came with your computer should look like the figure that follows.

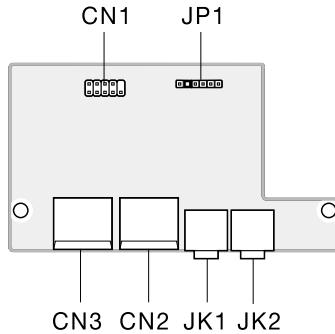

Label	Description
JP1	Audio connector - connects to the AUDIO2 connector of the mainboard
CN1	USB connector - connects to the USB2 connector of the mainboard
CN2 and CN3	USB ports
JK1	Microphone-in port (front) ^{see note}
JK2	Audio-out port



Note: The system has two microphone-in ports (front and rear). However, you can not use both of them at the same time. The default setting for your system enables the microphone-in port in front and disables the one at the back.

Installing additional memory

The three 168-pin sockets on the mainboard support Synchronous Dynamic Random Access Memory (SDRAM)-type DIMMs. You may install 32-MB, 64-MB, 128-MB, 256-MB, 512-MB or 1-GB single and double density DIMMs for a maximum memory capacity of 3 GB.

The SDRAM DIMMs should work under 3.3 volts; 5-volt memory devices are not supported. PC-100 (100MHz) and PC-133 (133 MHz) SDRAM are supported. Contact your dealer for qualified DIMM vendors.



.....

Caution: Do not install and use both PC-100 and PC-133 SDRAM together. Such a combination might cause your computer to malfunction.

Each of the DIMM sockets is independent from each other. This independence allows you to install DIMMs with different capacities to form different configurations.

To remove a DIMM



.....

Note: Observe the "Installation precautions" on page 43 when installing or removing a computer component. Also, make sure that you have removed the computer cover (see page 45).

1. Press the holding clips on both sides of the DIMM socket outward to release the DIMM (a).
2. Gently pull the DIMM out of the socket (b).

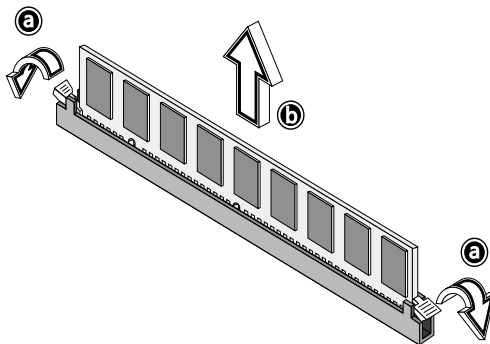

To install a DIMM



Note: Observe the “Installation precautions” on page 43 when installing or removing a computer component. Also, make sure that you have removed the computer cover (see page 45).

1. Open the clips on the socket.
2. Align the DIMM with the socket (a).
3. Press the DIMM into the socket until the clips lock onto the DIMM (b).

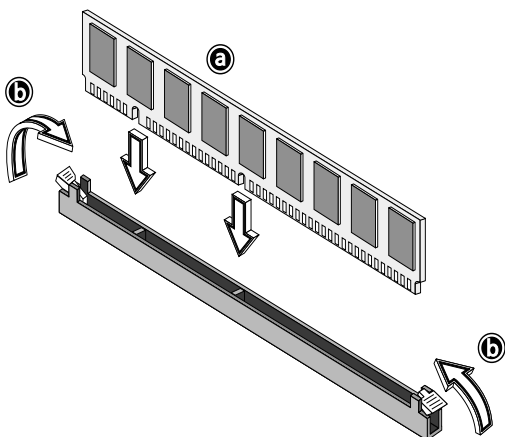

Note: The DIMM sockets are slotted to ensure proper installation. If you insert a DIMM but it does not fit easily into the socket, you may have inserted it incorrectly. Turn the DIMM and try to insert it again.

To reconfigure your computer

Your computer automatically detects the amount of memory installed. Run the BIOS utility to view the new value for total system memory and make a note of it. For more information on BIOS, refer to the Veriton 7200 online guide (see “Accessing the online guide” on page 6).

5 Software

This chapter describes the applications that came with your computer.

Your computer comes with the following applications:

- Acrobat® Reader™
- LDCM
- Norton AntiVirus
- NTI CD-Maker 2000
- PowerDVD
- VariSpeed
- BIOS utility

All of the applications that came with your computer are very easy to use. However, if you need more help and information, you may refer to the online help documentation provided in each software application.

Acrobat Reader

Acrobat Reader is a software that lets you view, navigate, browse and print Adobe Portable Document Format (PDF) files on all major computer platforms. Acrobat Reader can open your document across a broad range of hardware and software, and it will look exactly as you intended - with layout, fonts, links and images intact.

To run Acrobat Reader, double-click the Acrobat Reader icon on your Windows's desktop.

For more information about Acrobat Reader, you may refer to its Help menu.

LDCM

LANDesk Client Manager (LDCM) allows desktop management via the Web, standard network, or dial-up connections. It is compatible with the leading management specifications, such as Wired for Management 2.0, Desktop Management Interface (DMI) v2.0, and others.

LDCM may not have been preloaded on your computer. As such, you will need to install it. To do so,

1. Make sure that your computer is turned on.
2. Insert the Programs CD that came with your computer into the CD or DVD drive.
3. Follow all onscreen instructions until you finish the installation.



.....

Caution: Make sure that the CD is properly inserted into the CD or DVD drive. Improper insertion may damage both the CD and the CD or DVD drive. For instructions on how to insert a CD into your computer's CD or DVD drive, see page 19.



.....

Note: LDCM currently supports Windows Me and Windows 2000.

To run LDCM:

1. Double-click the LDCM icon on your Windows desktop.
2. Follow all onscreen instructions.

For more information on how to use the LDCM, refer to the LDCM Help menu.

Norton AntiVirus

Norton AntiVirus is an anti-virus software which finds and repairs infected files, protects against viruses to keep your computer data safe and secure. It also scans incoming email attachments for viruses. It provides useful virus detection and repair facilities.

To install Norton AntiVirus:

1. Double-click the Norton AntiVirus icon on your Windows desktop.
2. Follow all onscreen instructions until you finish installation.



Note: After you finish installing the Norton AntiVirus software, the system will automatically delete the Norton AntiVirus installer icon from your Windows desktop.

For more information about Norton AntiVirus, you may refer to the Norton AntiVirus Help menu.

NTI CD-Maker 2000 (for models with CD-RW)

The NTI CD-Maker 2000 is a CD-Recording software which allows you to create and copy audio, data and videos to CD-RW discs.

To run NTI CD-Maker 2000:

1. Double-click the NTI CD-Maker 2000 icon on your Windows desktop.
2. Follow all onscreen instructions.

For more information on how to use the NTI CD-Maker 2000, refer to the NTI CD-Maker 2000 Help menu.

PowerDVD (for models with DVD)

PowerDVD is a high-quality, pure software DVD player which brings high-quality movies and karaoke to your multimedia PC. You can play back high resolution DVD titles or MPEG-2 files with MPEG-2 video and Dolby Digital (AC-3) audio. PowerDVD provides a complete set of commands for navigation and advanced features such as multi-angle switching, multi-language and multi-subtitle selection, and parental control. It also has the i-Power Internet Enabling feature, which links to online DVD resources via the Power DVD Desktop Portal Page.

To run PowerDVD:

1. Double-click the PowerDVD icon on your Windows desktop.
2. Follow all onscreen instructions.

For more information about PowerDVD, refer to the PowerDVD Help menu.

VariSpeed (Windows Me only)

VariSpeed is a utility program which allows you to control the CD-ROM speed to reduce its noise level.

To set the speed of the CD-ROM drive, double-click on the VariSpeed icon on the taskbar and choose the Set Speed tab. The Set Speed screen will appear. Drag the lever to the desired level.



Note: This utility is available for AOpen CD-ROM drives only.

BIOS utility

The BIOS utility is a hardware configuration program built into your computer's Basic Input/Output System (BIOS). Since most computers are already properly configured and optimized, there is no need to run this utility. However, if you encounter configuration problems and get the "Run Setup" message, you will need to run this utility.



Note: Before you run BIOS, make sure that you have saved all open files. The computer reboots immediately after you exit Setup.

To run the BIOS utility, press the key combination **Ctrl+Alt+Esc**. For information about BIOS and how to configure your computer, refer to the Veriton 7200 online guide (see "Accessing the online guide" on page 6).

Reinstalling programs

If you uninstall one of the preinstalled programs and want to reinstall it, do the following:

1. Make sure that the system is turned on.
2. Insert the Programs CD into the CD or DVD drive.
3. Select the application that you want to reinstall.
4. Follow all onscreen instructions until you finish the installation.

6 Q & A

This chapter tells you what to do in case your computer is not working properly. However, if a more serious problem arises, contact your dealer or the technical support center (www.acersupport.com) for assistance.

The following questions are possible situations that may arise during the use of your computer and each is followed by easy answers and solutions to the situation.

Q: I pressed the power switch but the system did not boot up.

A: Check the LED located above the power switch.

If the LED is not lit, no power is being applied to the system. Do any of the following:

- Check if the voltage selector switch located on the rear panel of the computer is set to the correct voltage.
- Check if the main power switch located on the rear panel of the computer is turned ON (1). See "Turning on your computer" on page 29 for the location of the main power switch on your computer.
- Check if you plugged the power cable properly into an electrical outlet.
- If you are using a power strip or AVR, make sure that it is plugged in and turned on.

If the LED is lit, check the following:

- Is a nonbootable (nonsystem) diskette in the floppy drive? If yes, remove or replace it with a system diskette and press **Ctrl + Alt + Del** to restart your computer.
- The operating system files may be damaged or missing. Insert the startup disk you created during Windows setup into the floppy drive and press **Ctrl + Alt + Del** to restart your computer. This will automatically diagnose your system and make necessary fixes. However, if the diagnostic utility still reports a problem, then you may have to insert the Recovery CD that came with your system to restore it to its original factory default settings.



.....
Caution: Using the Recovery CD will erase all files previously saved in your computer so make sure to back up your important files before starting the recovery process. For more information about recovering your system, refer to the Veriton 7200 online guide.

Q: Nothing appears on the screen.

A: Your computer's power management function automatically blanks the screen to save power. Just press any key to turn the display back on.

If pressing a key does not work, you can restart your computer. If restarting your computer does not work, contact your dealer or the technical support center for assistance.

Q: The printer does not work.

A: Do the following:

- Make sure that the printer is connected to a power outlet and that it is turned on.
- Make sure that the printer cable is connected securely to the system's parallel port and the corresponding port on the printer. See "Printer" on page 32 for information on how to connect the printer to your computer.
- For additional information concerning the printer, refer to the printer's documentation.

Q: No sound comes out from the computer.

A: Check the following:

- The volume may be muted. Look for the Volume icon on the taskbar. If it is crossed-out, click on the icon and deselect the **Mute** option. You can also press the volume control/mute knob on your USB keyboard to toggle from mute to sound on.
- If headphones, earphones, or external speakers are connected to the line-out jack of your computer, the internal or built-in speakers are automatically turned off.

Q: System cannot read diskette, hard disk, CD or DVD information.

A: Check the following:

- Make sure that you are using the correct type of disc or diskettes. See "Disk drives" on page 18.
- Check if the diskette is formatted correctly. If not, format it again.



.....
Caution: If you reformat a diskette, you will lose all data on it.

- Make sure the diskette, CD or DVD is inserted into the drive correctly.
- Check if the CD or DVD is clean and not scratched.
- Check your drive by using a good (i.e., undamaged) diskette or a good disc. If your floppy drive, CD or DVD drive can not read the information on the good diskette, CD or DVD there may be a problem with the drive. Contact your dealer or technical support center for assistance.

Q: System cannot write diskette, hard disk or disc.

A: Check the following:

- Make sure the diskette or hard disk is not write-protected. See "Disk drives" on page 18.
- Make sure that you are using the correct type of diskette. See "Disk drives" on page 18.
- Check if the diskette is formatted correctly. If not, format it again.



.....
Caution: If you reformat a diskette, you will lose all data on it.

Index

A

- accessing the online guide 6
- applications 61

B

- BIOS utility 68

C

- computer maintenance 4
 - cleaning 4
 - servicing 4
- connecting options
 - multimedia devices 37
 - audio line-in device 39
 - earphones/headphones 37
 - external speakers 37
 - joystick 37
 - microphone 37
 - network 32, 34
 - printer 32
 - serial mouse 33

D

- disk drives 18
 - CD-ROM/DVD-ROM/CD-RW drive
 - inserting CDs/DVDs 19
 - taking care CDs/DVDs 20
 - floppy drive 18
 - not write-protect 18
 - write-protect 18
 - hard disk 20

F

- features 9
 - connectivity 9
 - multimedia 9
 - performance 9
- front panel 10

I

- internal components 48

K

- keyboard 14
 - application key 15

- caps lock 14
- cursor keys 15
- function key 14
- internet/suspend keys 16
- multimedia keys 16
- num lock 15
- palm rest 15
- programmable keys 16
- scroll lock 15
- volume control/mute 15
- Windows logo key 15

M

- mouse 17
 - buttons 17
 - clicking 17
 - double-click 17
 - ratchet wheel 17

Q

- Q&A 73
 - blank screen 74
 - no audio 74
 - no sound 74
 - printer not working 74
 - system cannot read disk 75
 - system cannot write to disk 75
 - system did not boot up 73

R

- rear panel 12
- remove the side panel 45

S

- safety instructions iv
- setting up computer 23, 25
 - area 23
 - chair 23
 - connecting peripherals
 - external monitor 27
 - power cable 28
 - USB keyboard 25
 - USB mouse 26
 - keyboard 24
 - monitor 24
 - mouse 24
- software 61
 - Acrobat Reader 62
 - LDCM 63

- Norton AntiVirus 64
- NTI CD-Maker 2000 65
- PowerDVD 66
- reinstalling programs 69
- VariSpeed 67
- system boards 53
 - audio board 56
 - mainboard 53

T

- turning off computer 31
 - software shutdown 31
 - suspend mode 31
- turning on computer 29
 - power button 29

U

- upgrade
 - add memory 57
 - install DIMM 58
 - reconfigure computer 58
 - computer 53, 57
 - installation precautions 43
 - ESD 43
 - post-installation 44
 - preinstallation 43
 - open computer
 - reinstall side panel 46
 - remove side panel 45
 - replace components 53, 57
- USB devices 35