

User's Manual

VB6002

Version 1.01
August 7, 2006

Copyright

Copyright © 2006 VIA Technologies Incorporated. All rights reserved.

No part of this document may be reproduced, transmitted, transcribed, stored in a retrieval system, or translated into any language, in any form or by any means, electronic, mechanical, magnetic, optical, chemical, manual or otherwise without the prior written permission of VIA Technologies, Incorporated.

Trademarks

All trademarks are the property of their respective holders. PS/2 is a registered trademark of IBM Corporation. Award BIOS is a registered trademark of Phoenix Technologies Ltd.

Macrovision

Apparatus Claims of U.S. Patent Nos. 4,631,603; 4,819,098; 4,907,093; 5,315,448; 6,516,132 licensed for limited viewing uses only. This product incorporates copyright protection technology that is protected by certain U.S. patents and other intellectual property rights owned by Macrovision and other rights owners. Use of this copyright protection technology must be authorized by Macrovision, and is intended for home and other limited viewing uses only unless otherwise authorized by Macrovision. Reverse engineering or disassembly is prohibited.

Disclaimer

No license is granted, implied or otherwise, under any patent or patent rights of VIA Technologies. VIA Technologies makes no warranties, implied or otherwise, in regard to this document and to the products described in this document. The information provided in this document is believed to be accurate and reliable as of the publication date of this document. However, VIA Technologies assumes no responsibility for the use or misuse of the information in this document and for any patent infringements that may arise from the use of this document. The information and product specifications within this document are subject to change at any time, without notice and without obligation to notify any person of such change.

FCC-B Radio Frequency Interference Statement

This equipment has been tested and found to comply with the limits for a class B digital device, pursuant to part 15 of the FCC rules. These limits are designed to provide reasonable protection against harmful interference when the equipment is operated in a commercial environment. This equipment generates, uses and can radiate radio frequency energy and, if not installed and used in accordance with the instruction manual, may cause harmful interference to radio communications. Operation of this equipment in a residential area is likely to cause harmful interference, in which case the user will be required to correct the interference at his personal expense.

Notice 1

The changes or modifications not expressly approved by the party responsible for compliance could void the user's authority to operate the equipment.

Notice 2

Shielded interface cables and A.C. power cord, if any, must be used in order to comply with the emission limits.



Tested To Comply
With FCC Standards
FOR HOME OR OFFICE USE

Safety Instructions

1. Always read the safety instructions carefully.
2. Keep this User's Manual for future reference.
3. Keep this equipment away from humidity.
4. Lay this equipment on a reliable flat surface before setting it up.
5. The openings on the enclosure are for air convection hence protects the equipment from overheating. DO NOT COVER THE OPENINGS.
6. Make sure the voltage of the power source and adjust properly 110/220V before connecting the equipment to the power inlet.
7. Place the power cord in such a way that people cannot step on it. Do not place anything over the power cord.
8. Always unplug the power cord before inserting any add-on card or module.
9. All cautions and warnings on the equipment should be noted.
10. Never pour any liquid into the opening. Liquid can cause damage or electrical shock.
11. If any of the following situations arises, get the equipment checked by a service personnel:
 - The power cord or plug is damaged
 - Liquid has penetrated into the equipment
 - The equipment has been exposed to moisture
 - The equipment has not work well or you cannot get it work according to User's Manual.
 - The equipment has dropped and damaged
 - If the equipment has obvious sign of breakage
12. DO NOT LEAVE THIS EQUIPMENT IN AN ENVIRONMENT UNCONDITIONED, STORAGE TEMPERATURE ABOVE 60 C (140F), IT MAY DAMAGE THE EQUIPMENT.

CAUTION: Explosion or serious damage may occur if the battery is incorrectly replaced. Replace only with the same or equivalent battery type recommended by the manufacturer.

Box Contents

- ☒ One VIA Mini-ITX mainboard
- ☒ One Quick Installation Guide
- ☒ One ATA-133/100 IDE ribbon cable
- ☒ One driver and utilities CD
- ☒ One IO bracket

TABLE OF CONTENTS

Box Contents.....	i
Table of Contents	ii
Chapter 1	1
Specifications	1
Mainboard Specifications	2
Mainboard Layout.....	4
Back Panel Layout.....	5
Back Panel Ports	6
Slots	6
Onboard Connectors	7
Onboard Jumpers.....	7
Chapter 2	8
Installation.....	8
CPU	9
Memory Module Installation	11
Connecting the Power Supply.....	12
Back Panel Ports	13
Connectors.....	16
Jumpers.....	24
Slots	26
Chapter 3	27
BIOS Setup	27
Entering Setup.....	28
Control Keys.....	29
Navigating the BIOS Menus	30
Getting Help.....	31
Main Menu	32
Standard CMOS Features	34
IDE Drives	35
Advanced BIOS Features	36
CPU Feature	39
Hard Disk Boot Priority.....	42
Advanced Chipset Features.....	43
AGP & P2P Bridge Control.....	45

CPU & PCI Bus Control	47
Integrated Peripherals	48
Super IO Device.....	51
Power Management Setup	53
Peripheral Activities.....	55
IRQs Activities	58
PNP/PCI Configurations.....	59
IRQ Resources	61
PC Health Status	62
Frequency / Voltage Control	63
Load Fail-Safe Defaults	67
Load Optimized Defaults.....	68
Set Supervisor / User Password	69
Save & Exit Setup	71
Exit Without Saving	72
Chapter 4	73
Driver Installation	73
Driver Utilities	74
CD Content	76

This page is left intentionally blank.

CHAPTER 1

Specifications

The ultra-compact and highly integrated VIA VB6002 uses the Mini-ITX mainboard form-factor developed by VIA Technologies, Inc. as part of the company's open industry-wide total connectivity initiative. The mainboard enables the creation of an exciting new generation of small, ergonomic, innovative and affordable embedded systems. Through a high level of integration, the Mini-ITX occupy 66% of the size of FlexATX mainboard form factor.

MAINBOARD SPECIFICATIONS

CPU

- Support Intel Pentium-M / Celeron-M Processor with Micro-FCPGA package (socket 479)

Chipset

- VIA VN800 North Bridge
- VIA VT8237R-series South Bridge

Graphics

- Integrated UniChrome™ Pro AGP with MPEG-2 Acceleration

Audio

- VIA VT1618 8-channel AC'97 Codec

Memory

- 1 x DDR2 533/400 DIMM slot (up to 1 GB)

Expansion Slot

- 1 x PCI slot

IDE

- 2 x UltraDMA 133/100 connectors

LAN

- VIA VT6103L 100/10 Base-TX Ethernet PHY
- VIA VT6107 10/100 Mbps Fast Ethernet (default) or VT6122 Gigabit Ethernet Controller

Back Panel I/O Ports

- 3 x Audio Jacks: line-out, line-in and mic-in (Horizontal, Smart 5.1 Support)
- 1 x PS/2 mouse port and 1 x PS/2 keyboard port
- 2 x RJ-45 LAN ports
- 1 x Serial port
- 4 x USB 2.0 ports
- 1 x VGA port

Onboard I/O Connectors

- 1 x ATX power connector
- 1 x Buzzer
- 1 x Digital I/O pin header
- 2 x Fan connectors (CPU Fan and System Fan)
- 1 x Front Panel audio pin header (Mic-in and Line-out)
- 1 x Front-Panel pin header
- 1 x FS1 pin header for CPU front side bus speed selection
- 1 x J2 pin header for VCCA selection
- 1 x KBMS pin header (KB/MS or CIR)
- 1 x LPC pin header
- 1 x LPT pin header
- 1 x LVDS/TTL/DVI (an add-on card is required)
- 1 x P4_1 pin header and 1 x P4_2 pin header for CPU type selection
- 1 x S_LED1 pin header for SATA LED/C4 function selection
- 1 x S/PDIF connector (S/PDIF-out)
- 2 x Serial ATA connectors
- 1 x Serial port pin header for COM 2 (5V/12V selectable)
- 1 x SIR pin header (IRDA 1.0)
- 1 x SM Bus pin header
- 2 x USB pin headers for 4 additional USB 2.0 ports
- 1 x WP pin header

BIOS

- Award BIOS with 4/8Mbit flash memory capacity
- ACPI2.0, SMBIOS2.1 and DMI2.2

Form Factor

- Mini-ITX (6 layers)
- 17 cm X 17 cm

MAINBOARD LAYOUT

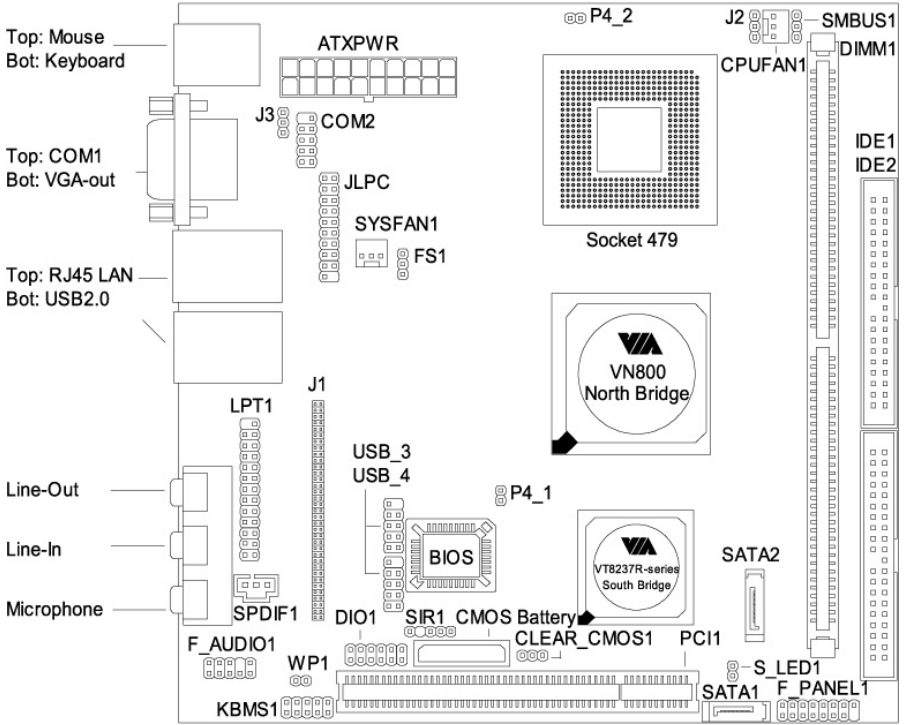

BACK PANEL LAYOUT

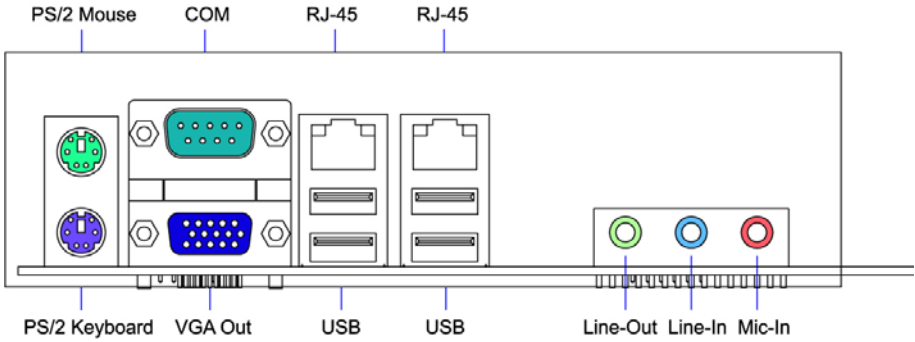

BACK PANEL PORTS

Port	Description	Page
Audio Jacks	3 Audio ports (line-out, line-in and mic-in)	15
COM1	Serial port 1	13
PS/2 Mouse	PS/2 mouse port	13
PS/2 Keyboard	PS/2 keyboard port	13
RJ45	RJ45 ports	14
USB	USB 2.0 ports	14
VGA	VGA port	13

SLOTS

Port	Description	Page
DDR2 DIMM	Memory module slot	11
PCI	Expansion card slot	26

ONBOARD CONNECTORS

Connector	Description	Page
ATXPWR	Power cable connector	12
COM 2	COM port 2 connector	20
CPUFAN	CPU fan connector	10
F_AUDIO	Front Audio connector	20
F_PANEL	Front panel connector	17
IDE 1-2	IDE drive connectors	16
KBMS	Keyboard and Mouse connector	22
LPC	LPC connector	22
LPT	LPT port connector	23
LVDS/TTL/DVI	LVDS/TTL/DVI connector	21-22
SATA 1-2	Serial ATA 1 and 2 connectors	18
SIR	Fast Infrared Radiation connector	19
SPDIF 1	SPDIF Out connector	18
SMBus	SMBus connector	18
SYSFAN	System fan connector	10
USB 3-4	Universal Serial Bus 2.0 connectors 3-4	19

ONBOARD JUMPERS

Jumper	Description	Page
CLEAR_CMOS	Reset CMOS settings	24
FS1	CPU Front Side Bus Speed setting	24
J2	VCCA setting	25
P4_1, P4_2	CPU type setting	25
S_LED1	SATA LED and C4 function setting	25
WP	BIOS write protection setting	25

CHAPTER 2

Installation

This chapter provides you with information about hardware installation procedures. It is recommended to use a grounded wrist strap before handling computer components. Electrostatic discharge (ESD) can damage some components.

CPU

The VIA VB6002 Mini-ITX mainboard can support Intel Pentium-M or Celeron-M Processors. These processors DO require a heatsink with fan to provide sufficient cooling.

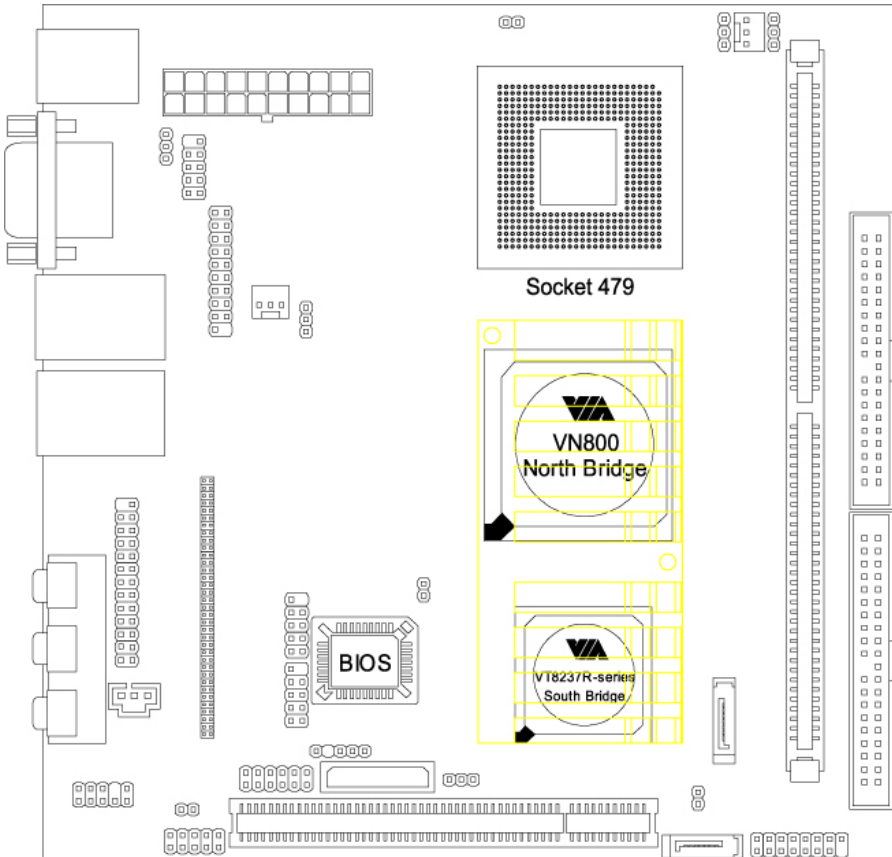

CPU Fan and System Fan: CPUFAN1 and SYSFAN1

The CPUFAN1 (CPU fan) and SYSFAN1 (system fan) run on +12V and maintain system cooling. When connecting the wire to the connectors, always be aware that the red wire is the Positive and should be connected to the +12V. The black wire is Ground and should always be connected to GND.

FAN_MCM is a switch that is used by high-quality fans to monitor the system temperature and will automatically adjust according to the environment.

CPUFAN1

Pin	Signal
1	FAN_MCM
2	+12V
3	GND

CPUFAN1



SYSFAN1

Pin	Signal
1	FAN_MCM
2	+12V
3	GND

SYSFAN1

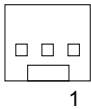

MEMORY MODULE INSTALLATION

The VIA VB6002 Mini-ITX mainboard provides one 240-pin DIMM slot for DDR2 533/400 SDRAM memory modules and supports the memory size up to 1GB.

DIMM

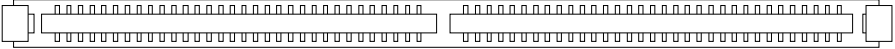

DDR2 SDRAM Module Installation Procedures

- Locate the DIMM slot in the motherboard.
- Unlock a DIMM slot by pressing the retaining clips outward.
- Align a DIMM on the socket such that the notch on the DIMM matches the break on the slot.
- Firmly insert the DIMM into the slot until the retaining clips snap back in place and the DIMM is properly seated.

Available DDR2 SDRAM Configurations

Refer to the table below for available DDR SDRAM configurations on the mainboard.

Slot	Module Size	Total
DIMM	64MB, 128MB, 256MB, 512MB, 1GB	64MB-1GB
Maximum supported system memory		64MB-1GB

CONNECTING THE POWER SUPPLY

The VIA VB6002 Mini-ITX mainboard supports a conventional ATX power supply for the power system. Before inserting the power supply connector, always make sure that all components are installed correctly to ensure that no damage will be caused.

ATX 20-Pin Power Connector

To connect the ATX power supply, make sure the power plug is inserted in the proper orientation and the pins are aligned. Then push down the plug firmly into the connector.

Pin	Signal
1	+3.3V
2	+3.3V
3	GND
4	+5V
5	GND
6	+5V
7	GND
8	Power Good
9	+5V Standby
10	+12V
11	+3.3V
12	-12V
13	GND
14	Power Supply On
15	GND
16	GND
17	GND
18	NC
19	+5V
20	+5V

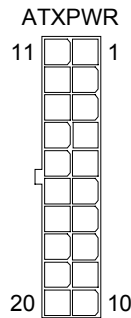

BACK PANEL PORTS

The back panel has the following ports:

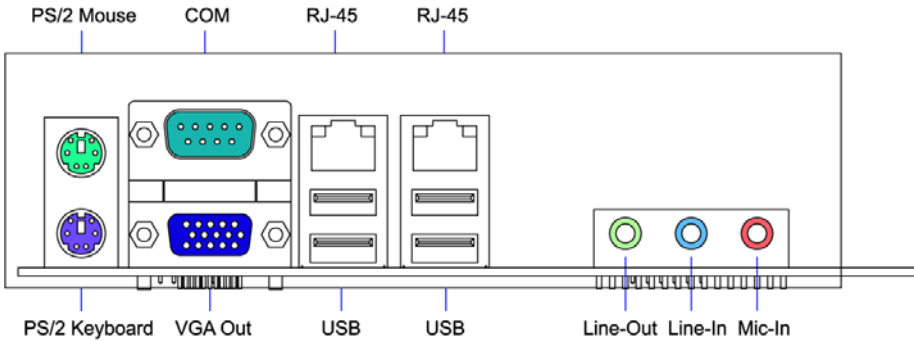

Keyboard and Mouse

The green 6-pin connector is for a PS/2 mouse. The purple connector is for a PS/2 keyboard.

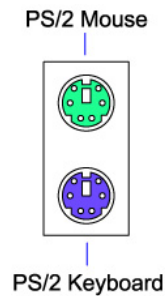

Serial port: COM 1

The green 9-pin COM 1 port is for pointing devices or other serial devices.

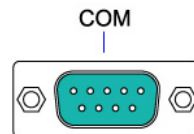

VGA Out

The blue 15-pin female VGA connector can be used to connect to any analog VGA monitor.

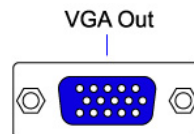

RJ45 10/100 LAN and USB Ports

The mainboard provides two standard RJ-45 and four USB 2.0 ports. These ports allow connection to a Local Area Network (LAN) through a network hub and USB 2.0 devices.

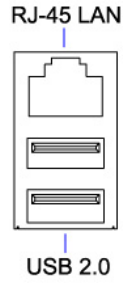

Audio Ports

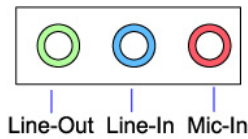

The Line-Out jack is for connecting to external speakers or headphones. The Line-In jack is for connecting to an external audio device such as a CD player, tape player, etc. The Mic jack is for connecting to a microphone.

Note:

The audio ports can be switched to Smart 5.1 6-channel audio output. You can enable the function by clicking the “Vinyl Audio” icon on your desktop after installing the audio driver.

After completing the previous installation, connect the speakers to the 3-jack connectors on the back panel.

Shown below are the corresponding connections to setup the 6-channel system.

Jack	2-channel	6-channel
Line-out	Line-out	Front (Left/Right)
Line-in	Line-in	Rear (Left/Right)
Microphone	Microphone	Center/Sub-woofer

CONNECTORS

Hard Disk Connectors: IDE1 & IDE2

The mainboard has a 32-bit Enhanced IDE and Ultra DMA 133/100 controller that provides PIO mode 0~4, Bus Master, and Ultra DMA 133/100 functions. You can connect up to four hard disk drives, CD-ROM and other devices.

The primary hard drive should always be connected to IDE1 as the master drive. Both IDE drives can connect to a master and a slave drive.

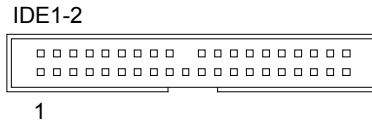

If two drives are connected to a single cable, the jumper on the second drive must be set to slave mode. Refer to the drive documentation supplied by the vendor for the jumper settings.

Case Connector: F_PANEL1

The F_PANEL1 pin header allows you to connect the power switch, reset switch, power LED, sleep LED, HDD LED and the case speaker.

Pin	Signal
1	+5V
3	+5V
5	-PLED_2
7	+5V
9	NC
11	NC
13	SPEAK
15	Key

Pin	Signal
2	+5V
4	HD_LED
6	PW_BN
8	GND
10	RST_SW
12	GND
14	+5V
16	-SLEEP_LED

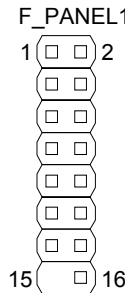

Power Switch (PW_BN)

Connect to a 2-pin power button switch. Pressing this button will turn the system power on or off.

Reset Switch (RST_SW)

The reset switch is used to reboot the system rather than turning the power ON/OFF. Avoid rebooting the system, if the HDD is still working. Connect the reset switch from the system case to this pin.

Power LED (-PLED_2)

The LED will light when the system is on. If the system is in S1 (POS - Power On Suspend) or S3 (STR - Suspend To RAM) state, the LED will blink.

HDD LED (HD_LED)

HDD LED shows the activity of a hard disk drive. Avoid turning the power off when the HDD LED still has a lit. Connect the HDD LED from the system case to this pin.

Speaker (SPEAK)

The speaker from the system case is connected to this pin.

Serial ATA Connectors: SATA1 and SATA2

These next generation connectors support the thin Serial ATA cables for primary internal storage devices. The current Serial ATA interface allows up to 150MB/s data transfer rate, faster than the standard parallel ATA with 133 MB/s (Ultra DMA).

SATA1-2

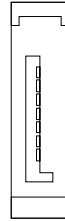

Digital Audio Connector: SPDIF1

This connector is for connecting the Sony Philips Digital Interface (S/PDIF) bracket. The S/PDIF output provides digital audio to external speakers or compressed AC3 data to an external Dolby Digital Decoder. The feature is available only with stereo system that has digital output function.

SPDIF1

Pin	Signal
1	+5V
2	S/PDIF Out
3	GND

SPDIF1

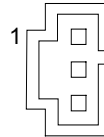

System Management Bus Connector: SMBUS1

This pin header allows you to connect SMBUS1 (System Management Bus) devices. Devices communicate with an SMBus host and/or other SMBus devices using the SMBus interface.

Pin	Signal
1	SMBCK
2	SMBDT
3	GND

SMBUS1

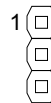

USB Pin Connector: USB_3-4

The mainboard provides 1 front USB pin header, allowing up to 2 additional USB2.0 ports up to maximum throughput of 480 Mbps. Connect each 2-port USB cable into this pin header. This port can be used to connect high-speed USB interface peripherals such as USB HDD, digital cameras, MP3 players, printers, modem and the like.

Pin	Signal
1	VCC
3	USBD_T4-
5	USBD_T4+
7	GND
9	Key

Pin	Signal
2	VCC
4	USBD_T5-
6	USBD_T5+
8	GND
10	GND

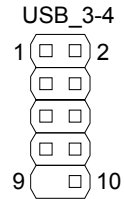

Fast IrDA Infrared Module Connector: SIR1

This pin header is used to connect to an IrDA module. The BIOS settings must be configured to activate the IR function.

Pin	Signal
1	+5V
2	Key
3	IRRX
4	GND
5	IRTX

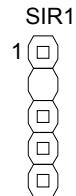

Serial Port Connector: COM2

COM2 pin header can be used to attach additional port for serial mouse or another serial device.

Pin	Signal	Pin	Signal
1	RIN12	2	RIN32
3	DOUT22	4	DOUT32
5	GND	6	RIN22
7	DOUT12	8	RIN42
9	-XRI2	10	Key

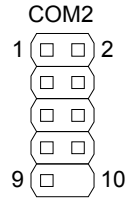

Front Panel Audio Connector: F_AUDIO1

This is an interface for the VIA front panel audio cable that allow convenient connection and control of audio devices. By default, the pins labeled LINE_OUT_R/NEXT_R and the pins LINE_OUT_L/NEXT_L are shorted with jumper caps. Remove the caps only when you are connecting the front panel audio cable.

Pin	Signal	Pin	Signal
1	FRON_MIC	2	AGND
3	MIC_BIAS	4	+5V
5	LINE_OUT_R	6	NEXT_R
7	NC	8	Key
9	LINE_OUT_L	10	NEXT_L

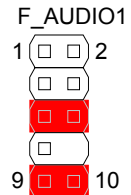

Note:
 If you don't want to connect to the front audio header, pins 5 & 6, 9 & 10 have to be jumpered in order to have signal output directed to the rear audio ports. Otherwise, the Line-Out connector on the back panel will not function.

LVDS/TTL/DVI Connector: J1

This connector works as the interface to multi display devices. An additional daughter card is required for a certain display support. Daughter cards for LVDS and DVI are currently available respectively.

Pin	Signal	Pin	Signal
1	DVID0	2	DVID1
3	DVID2	4	DVID3
5	DVID4	6	DVID5
7	DVID6	8	DVID9
9	DVID8	10	DVID7
11	DVID10	12	DVID11
13	DVIDE	14	DVICLK
15	DVIVS	16	NC
17	DVIHS	18	NC
19	GND	20	GND
21	+12V	22	+5V
23	+12V	24	+5V
25	GND	26	GND
27	+3.3V	28	GND
29	ENPVEE	30	GND
31	FPBKLP	32	ENPVDD
33	GFPD13	34	GFPDE
35	GND	36	GFPD17
37	GFPD23	38	GND
39	GFPVS	40	GFPHS
41	GFPD2	42	+5V
43	GFPD11	44	GFPD21
45	GFPD7	46	GFPD10
47	+3.3V	48	GFPD20
49	+3.3V	50	Key
51	GFPD9	52	GFPCLK
53	Key	54	NC
55	GFPD12	56	GND
57	GFPD15	58	GND
59	GFPD14	60	GND
61	GFPD16	62	GND
63	GFPD18	64	GFPD22
65	GFPD19	66	GFPD1
67	GFPD0	68	GFPD3
69	GND	70	GFPD4
71	GND	72	GFPD6
73	GFPD8	74	GFPD5
75	GND	76	GND
77	DVI_SBDT	78	DVI_SBCK
79	PWRGD_SB	80	GND

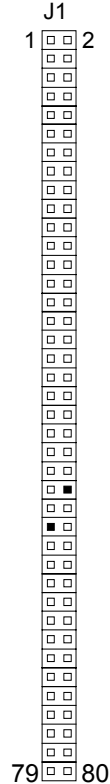

Note:

ENPVDD: Enable Panel VDD power
 ENPVEE: Enable Panel VEE power
 GFPD: Graphic Flat Panel Device signals

KBMS Connector: KBMS1

The mainboard provides a PS2 pin header to attach a PS2 keyboard and mouse.

Pin	Signal	Pin	Signal
1	+5VDUAL	2	GND
3	KB_CLK	4	KB_DATA
5	EKBCLK	6	EKBDATA
7	MS_CLK	8	MS_DATA
9	EMSCLK	10	EMSDATA

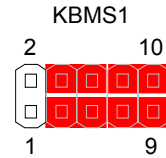

Note: When the pin header is not in use, please short pin 3&5, pin 4&6, pin 7&9 and pin 8&10.

LPC Connector: JLPC

This pin connector is for LPC devices.

Pin	Signal	Pin	Signal
1	LAD1	2	PCICLK_JLPC
3	-PCIRSTX	4	GND
5	LAD0	6	LPCSI0J
7	LAD2	8	-LFRAME
9	SERIRQ	10	LAD3
11	-LDRQ1	12	-EXTSMI
13	+5V	14	+3.3V
15	+5V	16	+3.3V
17	GND	18	GND
19	GND	20	Key

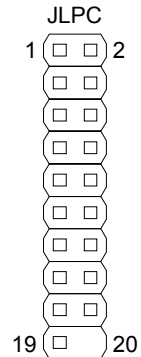

LPT Connector: LPT1

The mainboard provides a 26-pin connector to be able to connect a 25-pin female external connector for LPT (parallel port). A parallel port is a standard printer port that supports Enhanced Parallel Port (EPP) and Extended Capabilities Parallel Port (ECP) modes.

Pin	Signal
1	-LP_STB
3	LP_D0
5	LP_D1
7	LP_D2
9	LP_D3
11	LP_D4
13	LP_D5
15	LP_D6
17	LP_D7
19	-LP_ACK
21	LP_BUSY
23	LP_PE
25	LP_SLCT

Pin	Signal
2	-LP_AFD
4	-LP_ERR
6	-LP_INIT
8	-LP_SLIN
10	GND
12	GND
14	GND
16	GND
18	GND
20	GND
22	GND
24	GND
26	Key

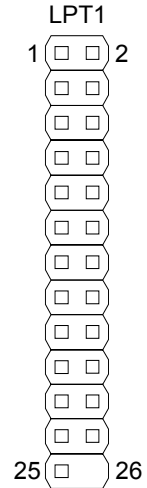

JUMPERS

The mainboard provides jumpers for setting some mainboard functions. This section will explain how to change the settings of the mainboard functions using the jumpers.

Clear CMOS: CLEAR_CMOS1

The onboard CMOS RAM stores system configuration data and has an onboard battery power supply. To reset the CMOS settings, set the jumper on pins 2 and 3 while the system is off. Return the jumper to pins 1 and 2 afterwards. Setting the jumper while the system is on will damage the mainboard.

Setting	1	2	3
Clear CMOS setting	OFF	ON	ON
Keep CMOS setting	ON	ON	OFF



WARNING: Except when clearing the RTC RAM, never remove the cap on CLEAR_CMOS1 jumper default position. Removing the cap will cause system boot failure. Avoid clearing the CMOS while the system is on; it will damage the mainboard.

CPU Front Side Bus Speed Select: FS1

This jumper is for selecting CPU Front Side Bus Speed between 533MHz and 400MHz. Setting: shorting pins 1 & 2 will select 533MHz, while shorting pins 2 & 3 will select 400MHz.

Setting	1	2	3
400MHz	OFF	ON	ON
533MHz	ON	ON	OFF

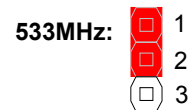

Intel Pentium® M or Celeron® M Select: J2, P4_1-2

These jumpers are for selecting between Intel Pentium® M or Celeron® M processors. Shorting pin 1 & 2 of J2 will select 1.8V VCCA power; shoring pin 2 & 3 will select 1.5V. For CPU type, shorting P4_1 and opening P4_2 will select Intel Pentium-M / Celeron-M.

J2 Setting	1	2	3
1.5V	OFF	ON	ON
1.8V	ON	ON	OFF

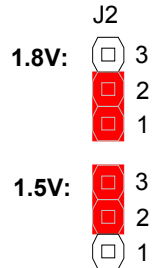

Setting	P4_1	P4_2
Intel Pentium-M / Celeron-M	ON	OFF

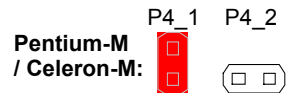

SATA LED / C4 Function Select: S_LED1

This jumper is for selecting between SATA LED and C4 function. Setting: shorting S_LED1 will enable SATA LED and disable C4 function (default); opening S_LED1 will enable C4 function and disable SATA LED.

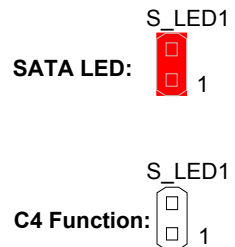

BIOS Write Protection: WP1

This jumper allows you to protect from flashing the BIOS. BIOS Write Protection setting: pin1 = /WP & /TBL, pin2 = GND, short 1-2.



SLOTS

Peripheral Component Interconnect: PCI

The PCI slot allows you to insert PCI expansion card. When adding or removing expansion card, unplug first the power supply. Read the documentation for the expansion card if any changes to the system are necessary.

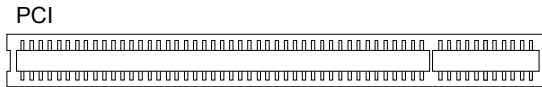

PCI Interrupt Request Routing

The IRQ (interrupt request line) are hardware lines over which devices can send interrupt signals to the microprocessor. The "PCI & LAN" IRQ pins are typically connected to the PCI bus INT A# ~ INT D# pins as follows:

	Order 1	Order 2	Order 3	Order 4
PCI Slot 1	INT B#	INT C#	INT D#	INT A#
PCI Slot 2	INT A#	INT B#	INT C#	INT D#

CHAPTER 3

BIOS Setup

This chapter gives a detailed explanation of the BIOS setup functions.

ENTERING SETUP

Power on the computer and press <Delete> during the beginning of the boot sequence to enter the BIOS setup menu. If you missed the BIOS setup entry point, you may restart the system and try again.

CONTROL KEYS

Keys	Description
Up Arrow	Move to the previous item
Down Arrow	Move to the next item
Left Arrow	Move to the item in the left side
Right Arrow	Move to the item in the right side
Enter	Select the item
Escape	Jumps to the Exit menu or returns to the main menu from a submenu
Page Up / +	Increase the numeric value or make changes
Page Down / -	Decrease the numeric value or make changes
F1	General help, only for Status Page Setup Menu and Option Page Setup Menu
F5	Restore the previous CMOS value from CMOS, only for Option Page Setup Menu
F6	Load the default CMOS value from Fail-Safe default table, only for Option Page Setup Menu
F7	Load Optimized defaults
F9	Jumps to the Main Menu
F10	Save all the CMOS changes and exit

NAVIGATING THE BIOS MENUS

The main menu displays all the BIOS setup categories. Use the control keys Up/Down arrow keys to select any item/sub-menu. Description of the selected/highlighted category is displayed at the bottom of the screen.

An arrow symbol next to a field indicates that a sub-menu is available (see figure below). Press <Enter> to display the sub-menu. To exit the sub-menu, press <Esc>.

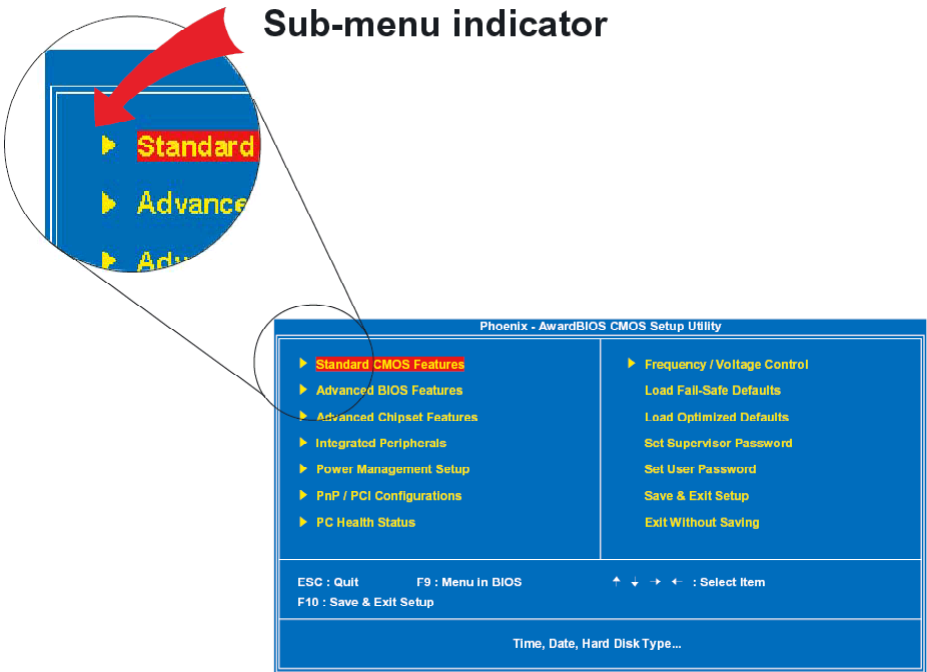

GETTING HELP

The BIOS setup program provides a "General Help" screen. You can display this screen from any menu/sub-menu by pressing <F1>. The help screen displays the keys for using and navigating the BIOS setup. Press <Esc> to exit the help screen.

MAIN MENU

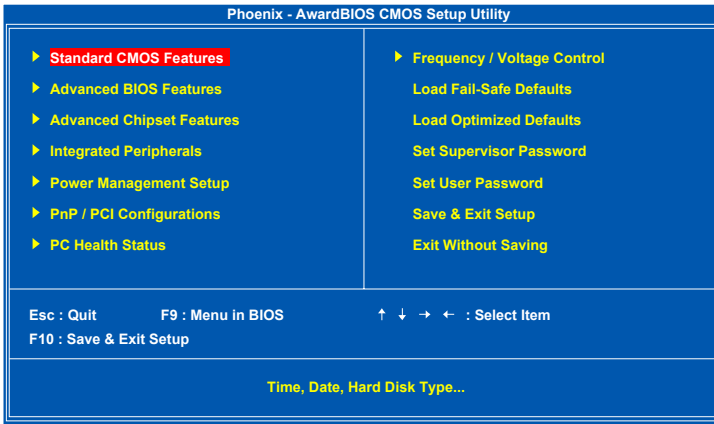

Standard CMOS Features

Use this menu to set basic system configurations.

Advanced BIOS Features

Use this menu to set the advanced features available on your system.

Advanced Chipset Features

Use this menu to set chipset specific features and optimize system performance.

Integrated Peripherals

Use this menu to set onboard peripherals features.

Power Management Setup

Use this menu to set onboard power management functions.

PnP/PCI Configurations

Use this menu to set the PnP and PCI configurations.

PC Health Status

This menu shows the PC health status.

Frequency/Voltage Control

Use this menu to set the system frequency and voltage control.

Load Fail-Safe Defaults

Use this menu option to load the BIOS default settings for minimal and stable system operations.

Load Optimized Defaults

Use this menu option to load BIOS default settings for optimal and high performance system operations.

Set Supervisor Password

Use this menu option to set the BIOS supervisor password.

Set User Password

Use this menu option to set the BIOS user password.

Save & Exit Setup

Save BIOS setting changes and exit setup.

Exit Without Saving

Discard all BIOS setting changes and exit setup.

STANDARD CMOS FEATURES

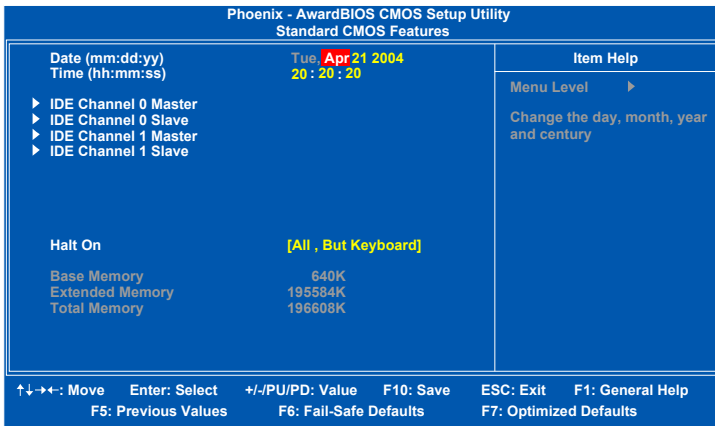

Date

The date format is [Day, Month Date Year]

Time

The time format is [Hour : Minute : Second]

Halt On

Sets the system's response to specific boot errors. Below is a table that details the possible settings.

Setting	Description
All Errors	System halts when any error is detected
No Errors	System does not halt for any error
All, But Keyboard	System halts for all non-key errors

IDE DRIVES

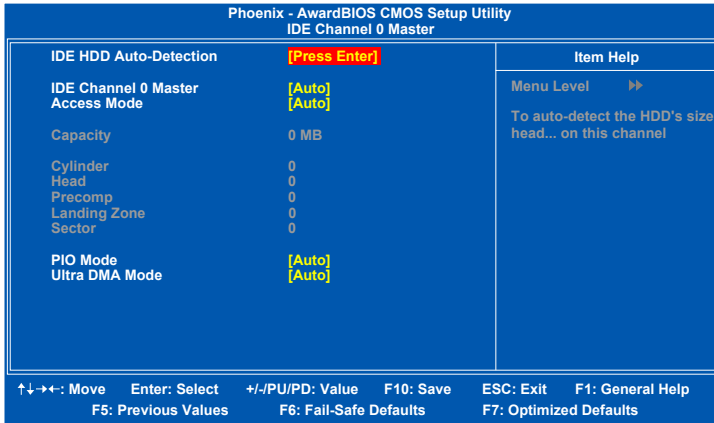

The specifications of your drive must match with the drive table. The hard disk will not work properly if you enter incorrect information in this category. Select "Auto" whenever possible. If you select "Manual", make sure the information is from your hard disk vendor or system manufacturer. Below is a table that details required hard drive information when using the "Manual" mode.

Setting	Description
IDE Channel	The name of this match the name of the menu. Settings: [None, Auto, Manual]
Access Mode	Settings: [CHS, LBA, Large, Auto]
Capacity	Formatted size of the storage device
Cylinder	Number of cylinders
Head	Number of heads
Precomp	Write precompensation
Landing Zone	Cylinder location of the landing zone
Sector	Number of sectors
PIO Mode	Settings: [0, 1, 2, 3, 4]
Ultra DMA Mode	Settings: [Disabled, Auto]

ADVANCED BIOS FEATURES

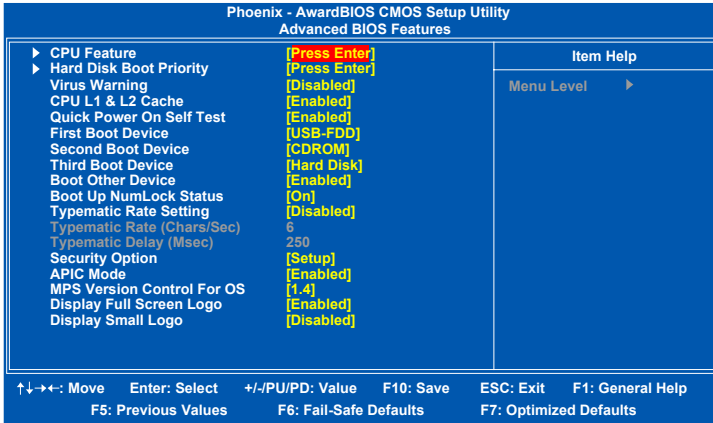

Virus Warning

Setting	Description
Enabled	Turns on hard disk boot sector virus protection
Disabled	Turns off hard disk boot sector virus protection

CPU L1 & L2 Cache

Setting	Description
Enabled	Turns on CPU L1 & L2 cache
Disabled	Turns off CPU L1 & L2 cache

Quick Power On Self-Test

Shortens Power On Self-Test (POST) cycle to enable shorter boot up time.

Setting	Description
Enabled	Shorten Power On Self Test (POST) cycle and bootup time
Disabled	Standard Power On Self Test (POST)

First/Second/Third Boot Device

Set the boot device sequence as BIOS attempts to load the disk operating system.

Setting	Description
LS120	Boot from LS-120 drive
Hard Disk	Boot from the HDD
CD-ROM	Boot from CD-ROM
ZIP100	Boot from ATAPI ZIP drive
USB-FDD	Boot from USB floppy drive
USB-ZIP	Boot from USB ZIP drive
USB-CDROM	Boot from USB CDROM
Legacy LAN	Boot from network drive
Disabled	Disable the boot device sequence

Boot Other Device

Enables the system to boot from alternate devices if the system fails to boot from the "First/Second/Third Boot Device" list.

Setting	Description
Enabled	Enable alternate boot device
Disabled	No alternate boot device allowed

Boot Up NumLock Status

Set the NumLock status when the system is powered on.

Setting	Description
On	Forces keypad to behave as 10-key
Off	Forces keypad to behave as arrow keys

Typematic Rate Setting

Enables "Typematic Rate" and "Typematic Delay" functions.

Settings: [Enabled, Disabled]

Typematic Rate (Chars/Sec)

This item sets the rate (characters/second) at which the system retrieves a signal from a depressed key.

Settings: [6, 8, 10, 12, 15, 20, 24, 30]

Typematic Delay (Msec)

This item sets the delay between when the key was first pressed and when the system begins to repeat the signal from the depressed key.

Settings: [250, 500, 750, 1000]

Security Option

Selects whether the password is required every time the System boots, or only when you enter Setup.

Setting	Description
Setup	Password prompt appears only when end users try to run BIOS Setup
System	Password prompt appears every time when the computer is powered on and when end users try to run BIOS Setup

APIC Mode

Enables APIC (Advanced Programmable Interrupt Controller) functionality.

Settings: [Enabled, Disabled]

MPS Variation Control for OS

Settings: [1.1, 1.4]

Display Full Screen Logo

Show full screen logo during BIOS boot up process.

Settings: [Enabled, Disabled]

Display Small Logo

Show small energy star logo during BIOS boot up process.

Settings: [Enabled, Disabled]

CPU FEATURE

This feature IS NOT SUPPORTED for Intel Pentium® M or Celeron® M processors.

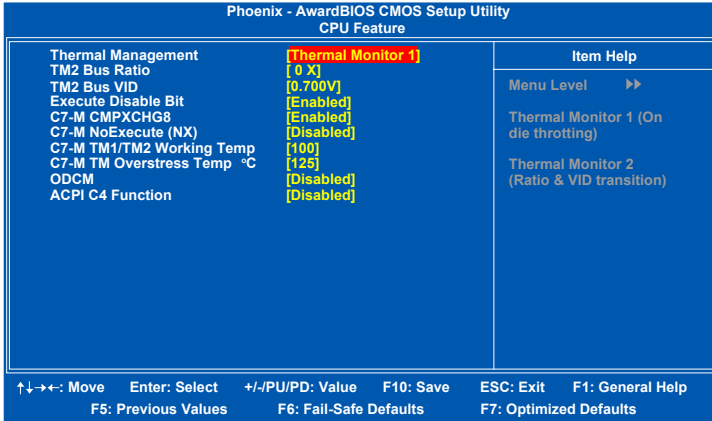

Thermal Management

This item sets CPU's thermal control rule to protect CPU from overheat.

Setting	Description
Thermal Monitor 1	On-die throttling
Thermal Monitor 2	Ratio & VID transition

TM2 Bus Ratio

This item sets the frequency (bus ratio) of the throttled performance that will be initiated when the on die sensor goes from not hot to hot.

Key in a DEC number.

Settings: [Min = 0, Max = 255]

TM2 Bus VID

This item sets the voltage of the throttled performance that will be initiated when the on die sensor goes from not hot to hot.

Settings: [0.700V, 0.716V, 0.732V, 0.748V, 0.764V, 0.780V, 0.796V, 0.812V, 0.828V, 0.844V, 0.860V, 0.876V, 0.892V, 0.908V, 0.924V, 0.940V, 0.956V, 0.972V, 0.988V, 1.004V, 1.020V, 1.036V, 1.052V, 1.068V, 1.084V, 1.100V, 1.116V, 1.132V, 1.148V, 1.164V, 1.180V, 1.196V, 1.212V, 1.228V, 1.244V, 1.260V, 1.276V, 1.292V, 1.308V, 1.324V, 1.340V, 1.356V, 1.372V, 1.388V, 1.404V, 1.420V, 1.436V, 1.452V, 1.468V, 1.484V, 1.500V, 1.516V, 1.532V, 1.548V, 1.564V, 1.580V, 1.596V, 1.612V, 1.628V, 1.644V, 1.660V, 1.676V, 1.692V, 1.708]

Execute Disable Bit

Settings: [Enabled, Disabled]

C7-M CMPXCHG8

Settings: [Enabled, Disabled]

C7-M NoExecute (NX)

Settings: [Enabled, Disabled]

C7-M TM1/TM2 Working Temp °C

This item sets the high threshold and the low threshold (lo = high-5°C).

Key in a DEC number.

Settings: [Min = 0, Max = 255]

C7-M TM Overstress Temp °C

Key in a DEC number.

Settings: [Min = 0, Max = 255]

ODCM

Enables the ODCM (On Demand Clock Modulation) functionality.

Settings: [12.5%, 25.0%, 37.5%, 50.0%, 62.5%, 75.0%, 87.5%, Disabled]

ACPI C4 Function

Enables the ACPI (Advanced Configuration and Power Management Interface) C4 functionality.

Settings: [Enabled, Disabled]

HARD DISK BOOT PRIORITY

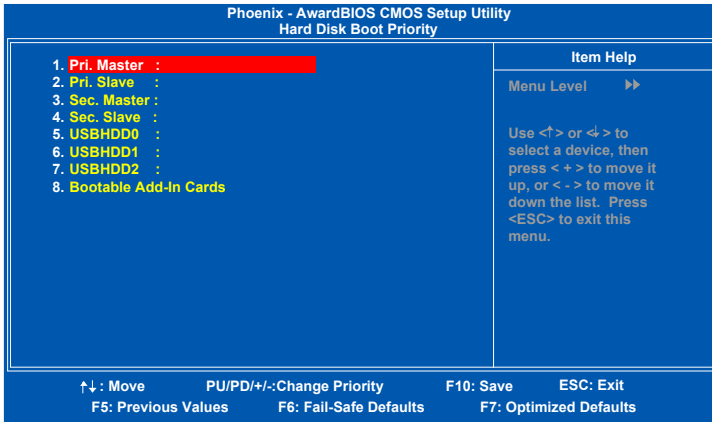

This is for setting the priority of the hard disk boot order when the "Hard Disk" option is selected in the "[First/Second/Third] Boot Device" menu item.

ADVANCED CHIPSET FEATURES

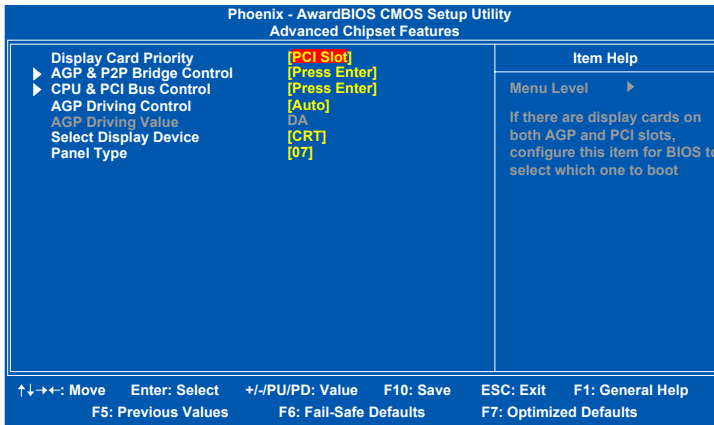

WARNING: The Advanced Chipset Features menu is used for optimizing the chipset functions. Do not change these settings unless you are familiar with the chipset.

Display Card Priority

This setting specifies which VGA card is your primary graphics adapter.

Settings: [PCI Slot, AGP]

AGP Driving Control

This item is used to signal driving current on AGP cards to auto or manual.

Settings: [Auto, Manual]

AGP Driving Value

Key in a HEX number.

Settings: [Min = 0000, Max = 00FF]

Select Display Device

This setting refers to the type of display being used with the system.

Settings: [CRT, LCD, CRT+LCD, DVI, CRT+DVI]

Panel Type

This setting refers to the native resolution of the display being used with the system.

Key in a HEX number.

Settings: [Min = 0000, Max = 000F]

AGP & P2P BRIDGE CONTROL

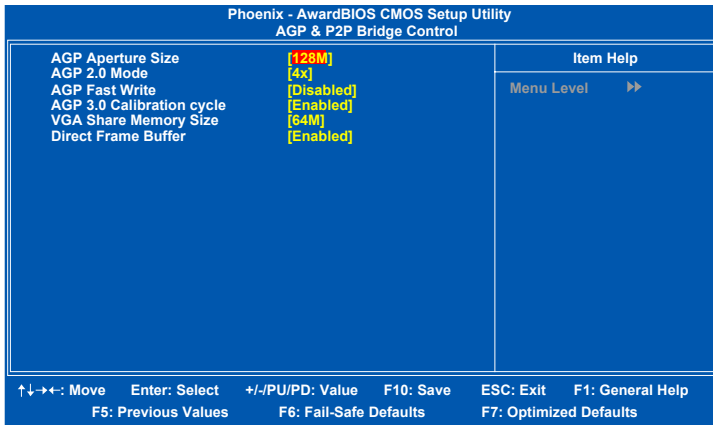

AGP Aperture Size

This setting controls how much memory space can be allocated to AGP for video purposes. The aperture is a portion of the PCI memory address range dedicated to graphics memory address space. Host cycles that hit the aperture range are forwarded to the AGP without any translation.

Settings: [32MB, 64MB, 128MB, 256MB, 512MB, 1G]

AGP 2.0 Mode

This mainboard supports the AGP 4x interface. When the AGP 4x video card is used, it can transfer video data at 1066MB/s. AGP 4x is backward compatible, leave the default 4x mode on. AGP 4x mode can be detected automatically once you plug in the AGP 4x card.

Settings: [4x, 2x, 1x]

AGP Fast Write

This item is used to enable or disable the caching of display data for the video memory of the processor.

Settings: [Enabled, Disabled]

AGP 3.0 Calibration Cycle

Settings: [Enabled, Disabled]

VGA Share Memory Size

Settings: [Disabled, 16M, 32M, 64M]

Direct Frame Buffer

Settings: [Enabled, Disabled]

CPU & PCI BUS CONTROL

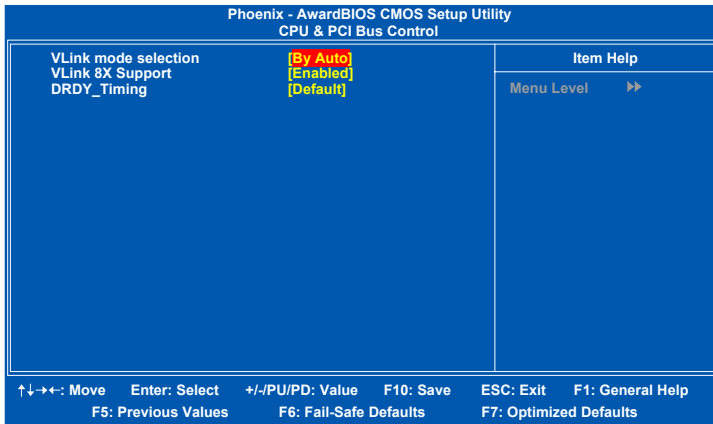

V-Link mode selection

This menu item controls the data transfer speed between the north and south bridge.

Settings: [By Auto, Mode 0~4]

V-Link 8X Support

Settings: [Enabled, Disabled]

DRDY_Timing

Settings: [Slowest, Default, Optimize]

INTEGRATED PERIPHERALS

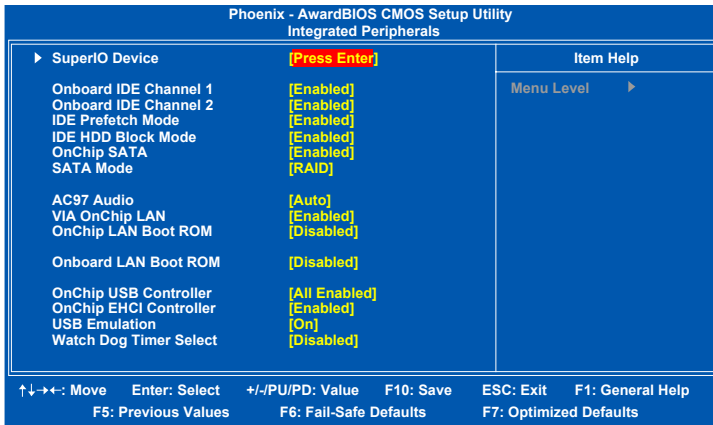

Onboard IDE Channel 1 and 2

The integrated peripheral controller contains an IDE interface with support for two IDE channels.

Setting	Description
Enabled	Activates each channel separately
Disabled	Deactivates IDE channels

IDE Prefetch Mode

Settings: [Enabled, Disabled]

IDE HDD Block Mode

This allows the hard disk controller to use the fast block mode to transfer data to and from the hard disk drive. Block mode is also called block transfer, multiple commands or multiple sector read / write.

Setting	Description
Enabled	Block mode
Disabled	Standard mode

OnChip SATA

Settings: [Enabled, Disabled]

SATA Mode

Serial ATA is the latest generation of the ATA interface. Serial ATA hard drives deliver transfer speeds of up to 150MB/sec.

Setting	Description
IDE	Supports two SATA plus two PATA hard disk drives
RAID	Only SATA supports RAID

AC'97 Audio

Auto allows the mainboard to detect whether an audio device is used. If the device is detected, the onboard VIA AC'97 (Audio Codec'97) controller will be enabled; otherwise, it is disabled. Disable the controller if another controller card is being used to connect to an audio device.

Setting	Description
Auto	Enables onboard controller if audio device is detected
Disabled	Turn off onboard controller to allow external controller

VIA OnChip LAN

Settings: [Enabled, Disabled]

OnChip LAN Boot ROM

Settings: [Enabled, Disabled]

OnBoard LAN Boot ROM

Settings: [Enabled, Disabled]

OnChip USB Controller

Settings: [All Disabled, All Enabled, 1&2 USB Port, 2&3 USB Port, 1&3 USB Port, 1 USB Port, 2 USB Port, 3 USB Port]

OnChip EHCI Controller

Settings: [Enabled, Disabled]

USB Emulation

Set this field to choose the USB emulation. When set to "OFF ", do not support any USB device on DOS. When set to "KB/MS", support USB legacy keyboard and mouse, no support USB storage. And set to "ON", support USB legacy keyboard, mouse and storage.

Settings: [OFF, KB/MS, ON]

Watch Dog Timer Select

Settings: [Disabled, 20 sec, 30 sec, 40 sec, 1 min, 2 min, 4 min]

SUPER IO DEVICE

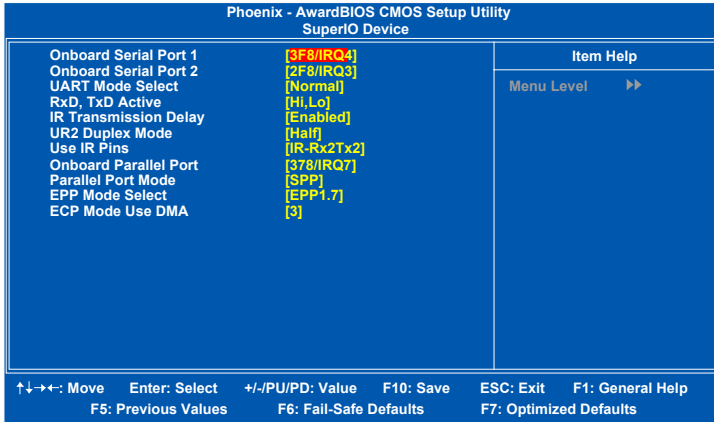

Onboard Serial Port 1/2

Sets the base I/O port address and IRQ for the onboard serial ports A and B. Selecting "Auto" allows the BIOS to automatically determine the correct base I/O port address.

Port	Settings					
1	Disabled	3F8 IRQ4	2F8 IRQ3	3E8 IRQ4	2E8 IRQ3	Auto
2	Disabled	3F8 IRQ4	2F8 IRQ3	3E8 IRQ4	2E8 IRQ3	Auto

UART Mode Select

Settings: [IrDA, ASKIR, Normal]

RxD, TxD Active

Settings: [Hi.Hi, Hi.Lo, Lo.Hi, Lo.Lo]

IR Transmission Delay

Settings: [Disabled, Enabled]

UR2 Duplex Mode

Settings: [Full, Half]

Use IR Pins

Settings: [Rx2Tx2, IR-Rx2Tx2]

Onboard Parallel Port

This specifies the I/O port address and IRQ of the onboard parallel port.

Settings: [Disabled, 378/IRQ7, 278/IRQ5, 3BC/IRQ7]

Parallel Port Mode

Set the parallel port mode. To operate the onboard parallel port as Standard Parallel Port, choose *SPP*. To operate the onboard parallel port in the EPP mode, choose *EPP*. By choosing *ECP*, the onboard parallel port will operate in ECP mode. Choosing *ECP + EPP* will allow the onboard parallel port to support both the ECP and EPP modes simultaneously.

Settings: [SPP, EPP, ECP, ECP+EPP, Normal]

EPP Mode Select

EPP (Enhanced Parallel Port) comes in two modes: 1.9 and 1.7. EPP 1.9 is the newer version of the protocol and is backwards compatible with most EPP devices. If your EPP device does not work with the EPP 1.9 setting, try changing the setting to EPP 1.7.

Settings: [EPP 1.9, EPP 1.7]

ECP Mode Use DMA

ECP (Extended Capabilities Port) has two DMA channels that it can use. The default channel is 3. However, some expansion cards may use channel 3 as well. To solve this conflict, change the ECP channel to 1. Select a DMA channel for the port.

Settings: [1, 3]

POWER MANAGEMENT SETUP

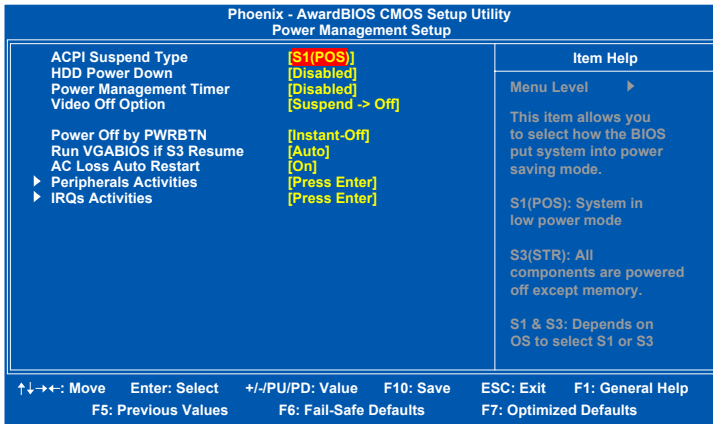

ACPI Suspend Type

Setting	Description
S1(POS)	S1/Power On Suspend (POS) is a low power state. In this state, no system context (CPU or chipset) is lost and hardware maintains all system contexts.
S3(STR)	S3/Suspend To RAM (STR) is a power-down state. In this state, power is supplied only to essential components such as main memory and wakeup-capable devices. The system context is saved to main memory, and context is restored from the memory when a "wakeup" event occurs.
S1 & S3	Depends on the OS to select S1 or S3.

HDD Power Down

Sets the length of time for a period of inactivity before powering down the hard disk.

Settings: [Disabled, 1~15(minutes)]

Power Management Timer

Set the idle time before system enters power saving mode. ACPI OS such as Windows XP will override this option.

Settings: [Disabled, 1/2/4/6/8/10/20/30/40(minutes), 1(hour)]

Video Off Option

Select whether or not to turn off the screen when system enters power saving mode, ACPI OS such as Windows XP will override this option.

Setting	Description
Always On	Screen is always on even when system enters power saving mode
Suspend -> Off	Screen is turned off when system enters power saving mode

Power Off by PWRBTN

This field configures the power button on the chassis.

Setting	Description
Delay 4 Sec	System is turned off if power button is pressed for more than four seconds
Instant-Off	Power button functions as a normal power-on/-off button

Run VGABIOS if S3 Resume

Select whether to run VGA BIOS if resuming from S3 state. This is only necessary for older VGA drivers.

Settings: [Auto, Yes, No]

AC Loss Auto restart

The field defines how the system will respond after an AC power loss during system operation.

Setting	Description
Off	Keeps the system in an off state until the power button is pressed
On	Restarts the system when the power is back
Former-Sts	Former-Sts

PERIPHERAL ACTIVITIES

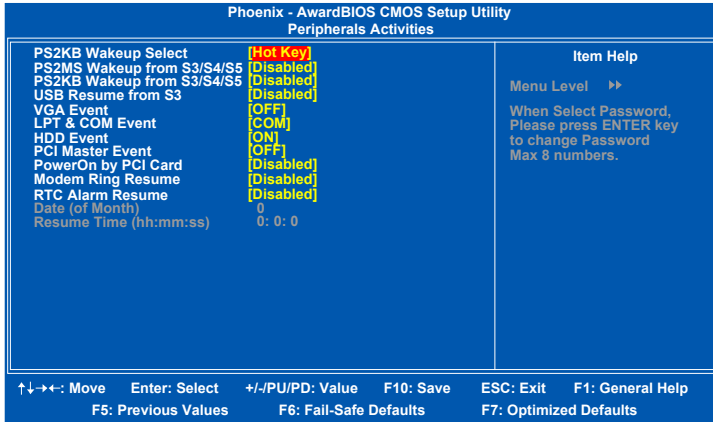

PS2KB Wakeup Select

When selecting "Password", press <Page Up> or <Page Down> to change password. The maximum number of characters is eight. "PS2MS Wakeup from S3/S4/S5" and "PS2KB Wakeup from S3/S4/S5" will be disabled while changing the password.

Settings: [Hot Key, Password]

PS2KB Wakeup from S3/S4/S5

Sets a Hot Key to restore the system from the power saving mode to an active state.

Settings: [Disabled, Ctrl+F1, Ctrl+F2, Ctrl+F3, Ctrl+F4, Ctrl+F5, Ctrl+F6, Ctrl+F7, Ctrl+F8, Ctrl+F9, Ctrl+F10, Ctrl+F11, Ctrl+F12, Power, Wake, Any Key]

PS2MS Wakeup from S3/S4/S5

Enables any mouse activity to restore the system from the power saving mode to an active state.

Settings: [Disabled, Enabled]

USB Resume from S3

Enables activity detected from USB devices to restore the system from a suspended state to an active state.

Settings: [Disabled, Enabled]

VGA Event

Enables the power management unit to monitor VGA activities.

Settings: [Off, On]

LPT & COM Event

Decide whether or not the power management unit should monitor LPT & serial port (COM) activities.

Settings: [None, COM]

HDD Event

Enables the power management unit to monitor hard disk activities.

Settings: [Off, On]

PCI Master Event

Enables the power management unit to monitor PCI master activities.

Settings: [Off, On]

PowerOn by PCI Card

Enables activity detected from any PCI card to power up the system or resume from a suspended state. Such PCI cards include LAN, onboard USB ports, etc.

Settings: [Disabled, Enabled]

Modem Ring Resume

Enables any Ring-In signals from the modem to restore the system from a suspended state to an active state.

Settings: [Disabled, Enabled]

RTC Alarm Resume

Sets a scheduled time and/or date to automatically power on the system.

Settings: [Disabled, Enabled]

Date (of Month)

The field specifies the date for "RTC Alarm Resume".

Resume Time (hh:mm:ss)

The field specifies the time for "RTC Alarm Resume".

IRQs ACTIVITIES

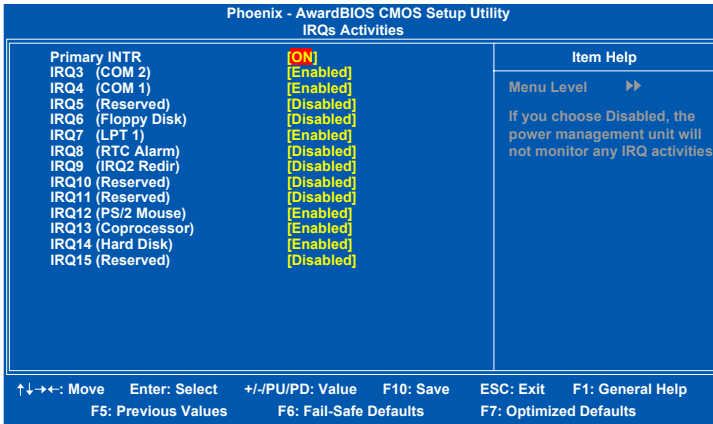

Primary INTR

Restores the system to an active state if IRQ activity is detected from any of the enabled channels

Settings: [Off, On]

IRQ3~IRQ15

Enables or disables the monitoring of the specified IRQ line. These fields are only available if "Primary INTR" is on.

Settings: [Enabled, Disabled]

NOTE: IRQ (Interrupt Request) lines are system resources allocated to I/O devices. When an I/O device needs to gain attention of the operating system, it signals this by causing an IRQ to occur. After receiving the signal, when the operating system is ready, the system will interrupt itself and perform the service required by the IO device.

PNP/PCI CONFIGURATIONS

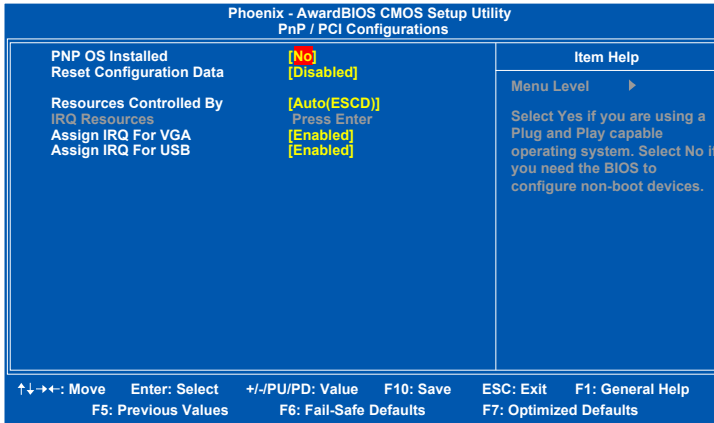

NOTE: This section covers some very technical items and it is strongly recommended to leave the default settings as is unless you are an experienced user.

PNP OS Installed

Setting	Description
Yes	BIOS will only initialize the PnP cards used for booting (VGA, IDE, SCSI). The rest of the cards will be initialized by the PnP operating system
No	BIOS will initialize all the PnP cards

Reset Configuration Data

This field should usually be left "Disabled".

Setting	Description
Enabled	Resets the ESCD (Extended System Configuration Data) after exiting BIOS Setup if a newly installed PCI card or the system configuration prevents the operating system from loading
Disabled	Default setting

Resource Controlled By

Enables the BIOS to automatically configure all the Plug-and-Play compatible devices.

Setting	Description
Auto(ESCD)	BIOS will automatically assign IRQ, DMA and memory base address fields
Manual	Unlocks "IRQ Resources" for manual configuration

Assign IRQ For VGA/USB

Assign IRQ for VGA and USB devices.

Settings: [Disabled, Enabled]

IRQ RESOURCES

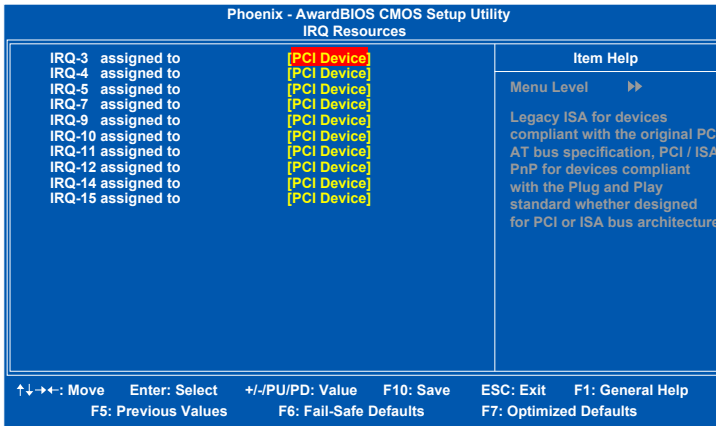

NOTE: The items are adjustable only when “Resources Controlled By” is set to “Manual.”

IRQ Resources list IRQ 3/4/5/7/9/10/11/12/14/15 for users to set each IRQ a type depending on the type of device using the IRQ.

Setting	Description
PCI Device	For Plug-and-Play compatible devices designed for PCI bus architecture
Reserved	The IRQ will be reserved for other requests

PC HEALTH STATUS

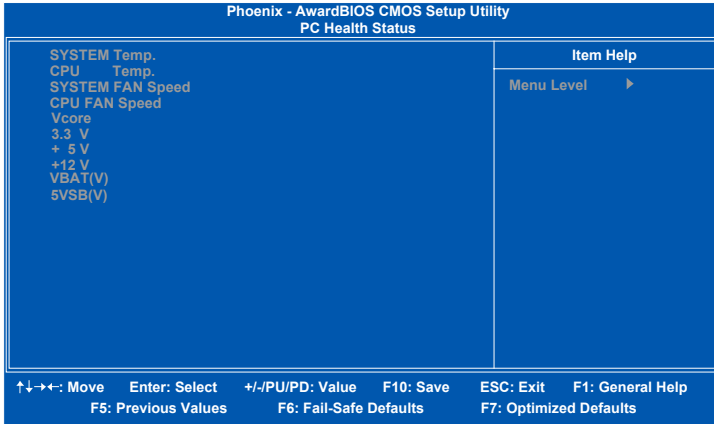

The PC Health Status displays the current status of all of the monitored hardware devices/components such as CPU voltages, temperatures and fan speeds.

FREQUENCY / VOLTAGE CONTROL

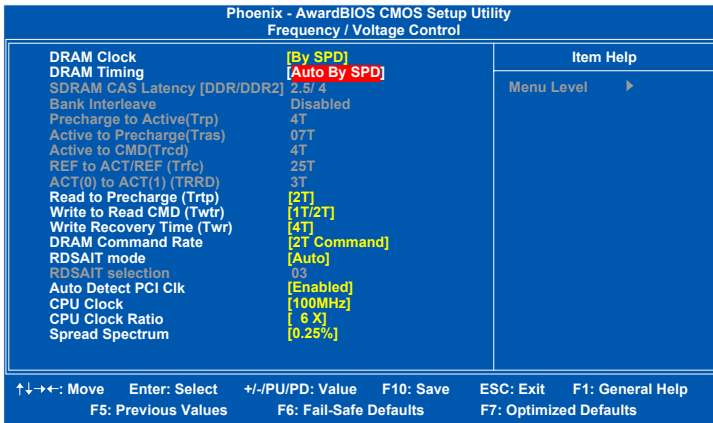

DRAM Clock

The chipset supports synchronous and asynchronous mode between host clock and DRAM clock frequency.

Settings: [By SPD, 100 MHz, 133 MHz, 166 MHz, 200MHz, 266MHz]

DRAM Timing

The value in this field depends on the memory modules installed in your system. Changing the value from the factory setting is not recommended unless you install new memory that has a different performance rating than the original modules.

Settings: [Manual, Auto By SPD, Turbo, Ultra]

SDRAM CAS Latency [DDR/DDR2]

This item is for setting the speed it takes for the memory module to complete a command. Generally, a lower setting will improve the performance of your system. However, if your system becomes less stable, you should change it to a higher setting. This field is only available when "DRAM Timing" is set to "Manual".

Settings: [1.5/2, 2/3, 2.5/4, 3/5]

Bank Interleave

This item is for setting the interleave mode of the SDRAM interface. Interleaving allows banks of SDRAM to alternate their refresh and access cycles. One bank will undergo its refresh cycle while another is being accessed. This improves performance of the SDRAM by masking the refresh time of each bank. This field is only available when "DRAM Timing" is set to "Manual".

Settings: [Disabled, 2 Bank, 4 Bank, 8 Bank]

Precharge to Active (Trp)

This field is for setting the length of time it takes to precharge a row in the memory module before the row becomes active. Longer values are safer but may not offer the best performance. This field is only available when "DRAM Timing" is set to "Manual".

Settings: [2T, 3T, 4T, 5T]

Active to Precharge (Tras)

This field is for setting the length of time it a row stays active before precharging. Longer values are safer but may not offer the best performance. This field is only available when "DRAM Timing" is set to "Manual".

Settings: [05T, 06~20T]

Active to CMD (Trcd)

This field is only available when "DRAM Timing" is set to "Manual".

Settings: [2T, 3T, 4T, 5T]

REF to ACT / REF (Trfc)

This field is only available when "DRAM Timing" is set to "Manual".

Settings: [08T, 09~71T]

ACT(0) to ACT(1) (TRRD)

This field is only available when "DRAM Timing" is set to "Manual".

Settings: [2T, 3T, 4T, 5T]

Read to Precharge (Trptp)

Settings: [2T, 3T]

Write to Read CMD (Twtr)

Settings: [1T/2T, 2T/3T]

Write Recovery Time (Twr)

Settings: [2T, 3T, 4T, 5T]

DRAM Command Rate

This field is for setting how fast the memory controller sends out commands. Lower setting equals faster command rate.

NOTE: Some memory modules may not be able to handle lower settings.

Settings: [2T Command, 1T Command]

RDSAIT Mode

Settings: [Manual, Auto]

RDSAIT Selection

Key in a HEX number.

Settings: [Min = 0000, Max = 003F]

Auto Detect PCI Clk

Settings: [Disabled, Enabled]

CPU Clock

Key in a DEC number.

Settings: [Min = 100, Max = 333]

CPU Clock Ratio

Key in a DEC number.

Settings: [Min = 8, Max = 50]

Spread Spectrum

When the mainboard's clock generator pulses, the extreme values (spikes) of the pulses create EMI (Electromagnetic Interference). The Spread Spectrum function reduces the EMI generated by modulating the pulses so that the spikes of the pulses are reduced to flatter curves.

Settings: [Disabled, 0.20%, 0.25%, 0.35%]

LOAD FAIL-SAFE DEFAULTS

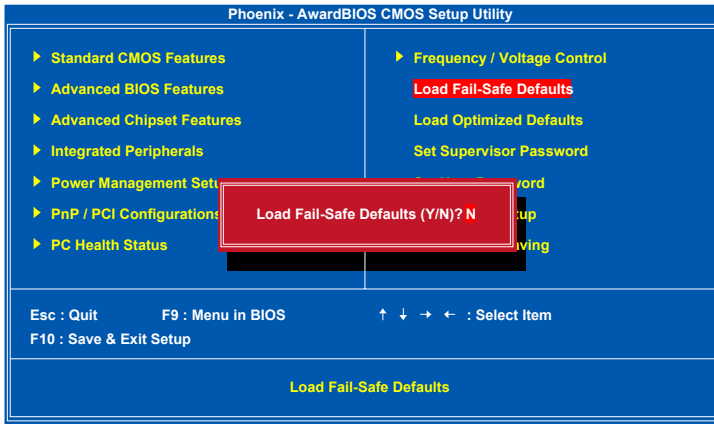

This option is for restoring all the default fail-safe BIOS settings. These values are set by the mainboard manufacturer to provide a stable system with basic performance.

Entering "Y" loads the default fail-safe BIOS values.

LOAD OPTIMIZED DEFAULTS

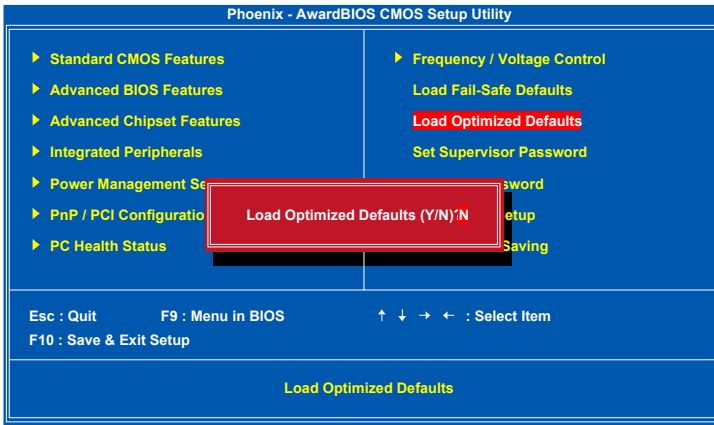

This option is for restoring all the default optimized BIOS settings. The default optimized values are set by the mainboard manufacturer to provide a stable system with optimized performance.

Entering "Y" loads the default optimized BIOS values.

SET SUPERVISOR / USER PASSWORD

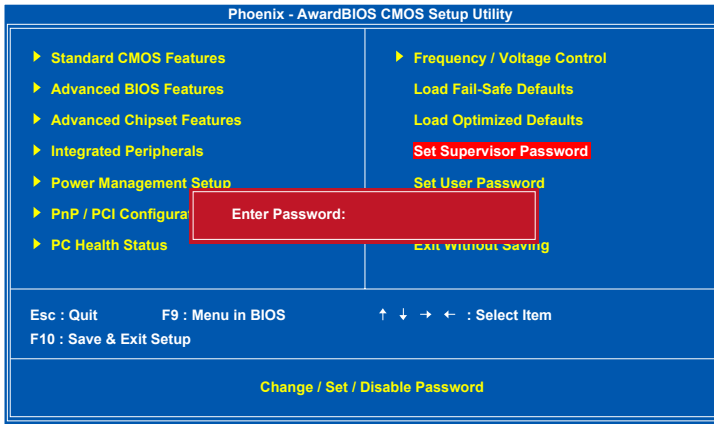

This option is for setting a password for entering BIOS Setup. When a password has been set, a password prompt will be displayed whenever BIOS Setup is run. This prevents an unauthorized person from changing any part of your system configuration.

There are two types of passwords you can set. A supervisor password and a user password. When a supervisor password is used, the BIOS Setup program can be accessed and the BIOS settings can be changed. When a user password is used, the BIOS Setup program can be accessed but the BIOS settings cannot be changed.

To set the password, type the password (up to eight characters in length) and press <Enter>. The password typed now will clear any previously set password from CMOS memory. The new password will need to be reentered to be confirmed. To cancel the process press <Esc>.

To disable the password, press <Enter> when prompted to enter a new password. A message will show up to confirm disabling the password. To cancel the process press <Esc>.

Additionally, when a password is enabled, the BIOS can be set to request the password each time the system is booted. This would prevent unauthorized use of the system. See "Security Option" in the "Advanced BIOS Features" section for more details.

SAVE & EXIT SETUP

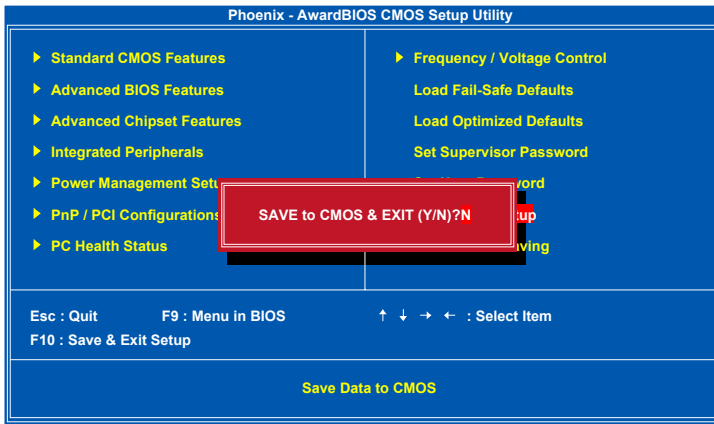

Entering "Y" saves any changes made and exits the program.

Entering "N" will cancel the exit request.

EXIT WITHOUT SAVING

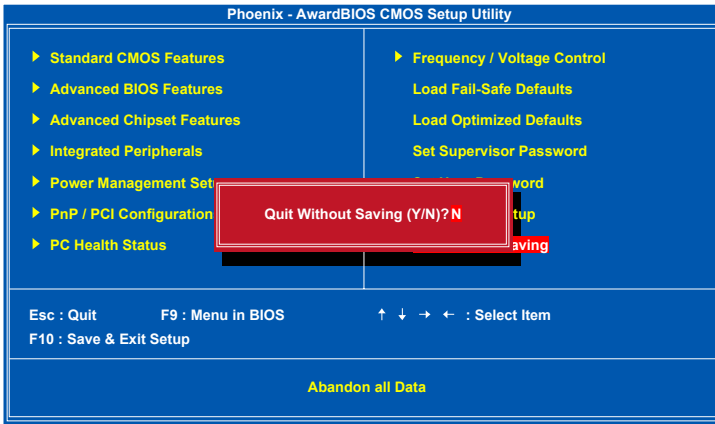

Entering "Y" discards any changes made and exits the program.

Entering "N" will cancel the exit request.

CHAPTER 4

Driver Installation

This chapter gives you brief descriptions of each mainboard driver and application. You must install the VIA chipset drivers first before installing other drivers such as audio or VGA drivers. The applications will only function correctly if the necessary drivers are already installed.

DRIVER UTILITIES

Getting Started

The mainboard includes a Driver Utilities CD that contains the driver utilities and software for enhancing the performance of the mainboard. If the CD is missing from the retail box, please contact the local dealer for the CD.

Note: The driver utilities and software are updated from time to time. The latest updated versions are available at <http://www.viaembedded.com/>

Running the Driver Utilities CD

To start using the CD, insert the CD into the CD-ROM or DVD-ROM drive. The CD should run automatically after closing the CD-ROM or DVD-ROM drive. The driver utilities and software menu screen should then appear on the screen. If the CD does not run automatically, click on the "Start" button and select "Run..." Then type: "D:\Setup.exe".

NOTE: D: might not be the drive letter of the CD-ROM/DVD-ROM in your system.

CD CONTENT

- ☒ **VIA 4in1 Drivers:** Contains VIA ATAPI Vendor Support Driver (enables the performance enhancing bus mastering functions on ATA-capable Hard Disk Drives and ensures IDE device compatibility), AGP VxD Driver (provides service routines to your VGA driver and interface directly to hardware, providing fast graphical access), IRQ Routing Miniport Driver (sets the system's PCI IRQ routing sequence) and VIA INF Driver (enables the VIA Power Management function).
- ☒ **VIA Graphics Driver:** Enhances the onboard VIA graphic chip.
- ☒ **VIA Audio Driver:** Enhances the onboard VIA audio chip.
- ☒ **VIA USB 2.0 Driver:** Enhances VIA USB 2.0 ports.
- ☒ **VIA LAN Driver:** Enhances the onboard VIA 10/100M LAN chip.
- ☒ **VIA GigaLAN Driver:** Enhances the onboard optional VIA VT6122 10/100/1000M LAN chip.
- ☒ **VIA RAID Driver:** Support for SATA RAID devices.