

---

---

## **FCC Information and Copyright**

This equipment has been tested and found to comply with the limits of a Class B digital device, pursuant to Part 15 of the FCC Rules. These limits are designed to provide reasonable protection against harmful interference in a residential installation. This equipment generates, uses and can radiate radio frequency energy and, if not installed and used in accordance with the instructions, may cause harmful interference to radio communications. There is no guarantee that interference will not occur in a particular installation.

The vendor makes no representations or warranties with respect to the contents here of and specially disclaims any implied warranties of merchantability or fitness for any purpose. Further the vendor reserves the right to revise this publication and to make changes to the contents here of without obligation to notify any party beforehand.

Duplication of this publication, in part or in whole, is not allowed without first obtaining the vendor's approval in writing.

The content of this user's manual is subject to be changed without notice and we will not be responsible for any mistakes found in this user's manual. All the brand and product names are trademarks of their respective companies.

---

---

---

---

## Table of Contents

---

---

<b>Notice .....</b>	<b>1</b>
<b>Mainboard Features .....</b>	<b>2</b>
1. Features Introduction.....	2
1-1. Hardware.....	2
1-2. BIOS & Software.....	6
1-3. Package Contents.....	6
2. Mainboard Configuration.....	7
2-1. Layout of U8768.....	7
2-2. Component Index.....	8
3. CPU Configuration.....	9
3-1. CPU Socket 478 Configuration Steps:.....	9
3-2. CPU Fan Header: JCFAN1.....	10
3-3. System Fan Header: JSFAN1.....	11
4. Jumpers, Headers & Connectors.....	12
4-1. Front Panel Connector: JPANEL1.....	13
4-2. ATX 20-pin Power Connector: JATXPWR1.....	15
4-3. Hard Disk Connectors: IDE1/IDE2.....	15
4-4. Floppy Disk Connector: FDD1.....	16
4-5. Wake On LAN Header: JWOL1.....	16
4-6. Clear CMOS Jumper: JCMOS1.....	16
4-7. Front USB Header: JUSB3.....	17
4-8. Front USB Header: JUSB4.....	17
4-9. 5V / 5VSB Selection for KB: JKBV1.....	17

## Table of Contents

---

---

4-10. ATX 12V Power Connector: JATXPWR2.....	18
4-11. 5V / 5VSB Selection for USB: JUSBV1.....	18
4-12. 5V / 5VSB Selection for USB: JUSBV3.....	18
4-13. 5V / 5VSB Selection for USB: JUSBV4.....	18
5. RAM Module Configuration.....	19
5-1. DDR SDRAM.....	19
5-2. How to install DDR DIMM Module.....	20
6. Peripheral Port Features.....	21
6-1. PS/2 Mouse / Keyboard Connector: JKBMS1.....	21
6-2. USB & LAN Port Connectors: JUSBLAN1.....	22
6-3. Serial and Parallel Interface Ports.....	24
6-6. Audio Subsystem.....	28

## Notice

### **Introduction of system**

This mainboard is designed to take advantage of the latest industry technology to provide you with the ultimate solution in data processing. In the tradition of its predecessors, this mainboard continues a commitment to reliability and performance and strives for full compliance and compatibility with industry software and hardware standards.

### **U8768 Features:**

1. Contains on board I/O facilities that include two serial ports, a parallel port, a PS/2 mouse port, a PS/2 keyboard port, audio ports, USB ports and a game port.
2. Contains on board IDE facilities for IDE devices such as hard disks and CD-ROM Drives.
3. Supports the Intel Pentium<sup>®</sup> 4 processor, a leading edge processor. Complies with PC Micro-ATX form factor specifications.
4. Supports popular operating systems such as Windows NT, Windows 2000, Windows ME, Windows XP, Novell, LINUX and SCO UNIX.

# Mainboard Features

## 1. Features Introduction

### 1-1. Hardware

**CPU:**

1. Provides Socket-478.
2. Supports the Intel Pentium® 4 processor providing the new generation power for high-end workstations and servers.

**Speed:**

1. Running at 533 MHz Front Side Bus frequency.
2. Supports up to 2.53 GHz CPU core speeds.
3. The 33MHz 32 bit PCI 2.2 compliant.
4. The 66MHz AGP 2.0 compliant interface supports 1x, 2x and 4x data transfer mode.

**Chipset:**

Chipset – VIA VT8753E (P4X266E)/ VT8235.

**Super I/O**

Chipset – ITE 8705

**DRAM Memory:**

1. Supports 200MHz, 266MHz DDR SDRAM devices.
2. Supports 64Mb, 128Mb, 256Mb and 512Mb technologies for x8 and 16 devices.
3. Max of 2 Double-Sided DDR SDRAM with unbuffered / Registered.
4. The largest memory capacity is 2 GB.

**Shadow RAM:**

Motherboard is equipped with a memory controller providing shadow RAM and support for ROM BIOS.

**Green Functionality:**

1. Supports Award BIOS™ power management functionality.
2. Has a power down timer from 1 to 15 minutes.

**BUS Slots:**

1. Contains 1 AGP slot.
2. Contains 1 CNR slot.
3. Contains 3 32-bit PCI bus slots

**Flash Memory:**

1. Supports flash memory functionality.
2. Supports ESCD functionality.

**Built in IDE Facilities:**

1. Supports four IDE hard disk drives.
2. Supports PIO Mode 4, Master Mode, and high performance hard disk drives.
3. Supports disk transfer rates up to 133 MB/second.
4. Supports Ultra DMA 33, Ultra DMA 66, Ultra DMA 100, Ultra DMA 133 Bus Master Modes.
5. Supports IDE interface with CD-ROM.
6. Supports high capacity hard disk drives.
7. Supports LBA mode.

**AC'97 Sound Codec Onboard:**

1. AC-LINK protocol compliance.
2. Compliant with AC'97 specification.
3. 18-bit full duplex stereo ADC, DACs.
4. SNR>95 Bb throughmixer and DAC.
5. Full-duplex codec.
6. Earphone buffer.
7. Line in/ Rear out share jack capability.
8. Mic in/ Center and Bass out share jack capability.
9. Internal PLL built-in saving additional crystal.
10. Meet Microsoft's ® PC2001 requirements.
11. Support 6-CH speaker mode.

**I/O facilities:**

1. One multi-mode Parallel Port capable of supporting the following specifications:
  - Standard & Bidirection Parallel Port.
  - Enhanced Parallel Port (EPP).
  - Extended Capabilities Port (ECP).
  - Normal
2. Supports two serial ports, 16550 UART.
3. Supports Infrared Data Transmission using IrDA.
4. Supports PS/2 mouse and PS/2 keyboard.
5. Supports 360KB, 720KB, 1.2MB, 1.44MB, and 2.88MB floppy disk drives.

**Universal Serial Bus:**

Supports two back panel Universal Serial Bus Port and four front panel Universal Serial Bus Ports.

**Hardware Monitor Function:**

1. Monitors CPU Fan Speed.
2. Monitors System Voltage.

***Dimensions (MATX form-factor):***  
*24.5cm x 22.8cm (WxL)*



**1-2. BIOS & Software**

1. Award legal BIOS.
2. Supports APM1.2.
3. Supports USB Function.
4. Supports ACPI.

**Operating System:**

Offers the highest performance for MS-DOS, Windows NT, Windows 2000, Windows ME, Windows XP, Novell, LINUX, and SCO UNIX etc.

**1-3. Package Contents**

1. HDD Cable.
2. FDD Cable.
3. Flash Memory Writer for BIOS Update.
4. USB Cable (Optional).
5. Rear I/O Panel for MATX Case (Optional).
6. Fully Setup Driver CD.

## 2. Mainboard Configuration

### 2-1. Layout of U8768

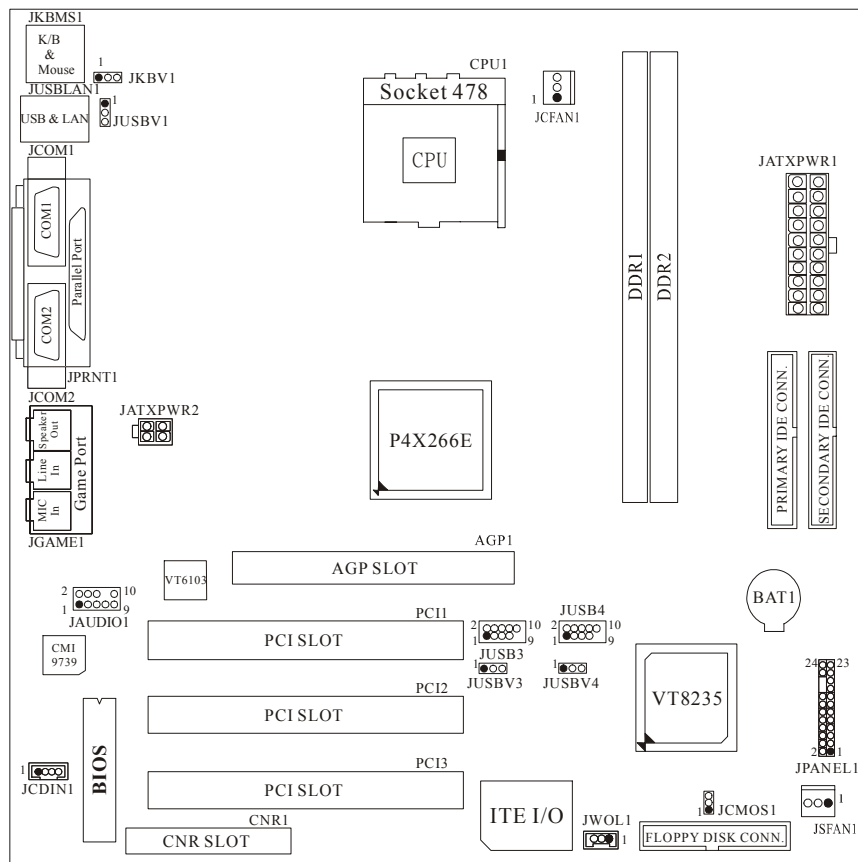

## 2-2. Component Index

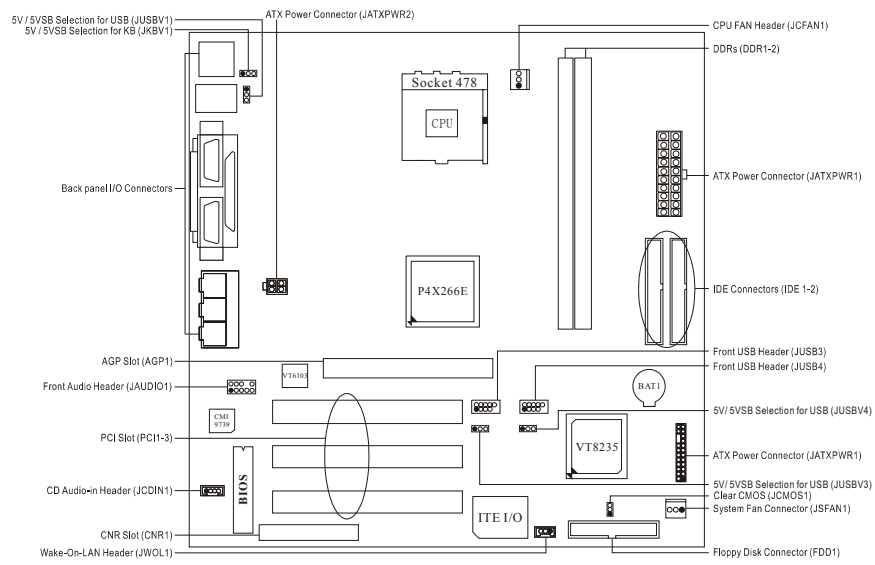

## 3. CPU Configuration

### 3-1. CPU Socket 478 Configuration Steps:

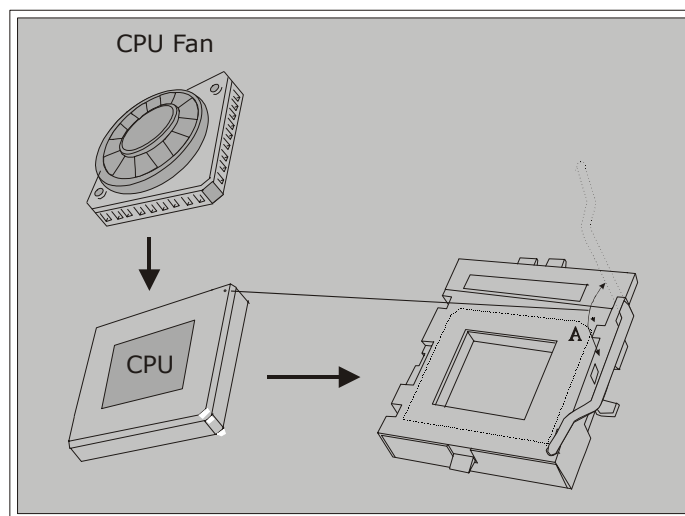

1. Pull the lever sideways away from the socket then raise the lever up to a 90-degree angle.
2. Locate Pin A in the socket and look for the white dot or cut edge in the CPU. Match Pin A with the white dot/cut edge then insert the CPU.
3. Press the lever down. Then Put the fan on the CPU and buckle it and put the fan's power port into the JCFAN1, then to complete the installation.

**CPU Configuration Layout**

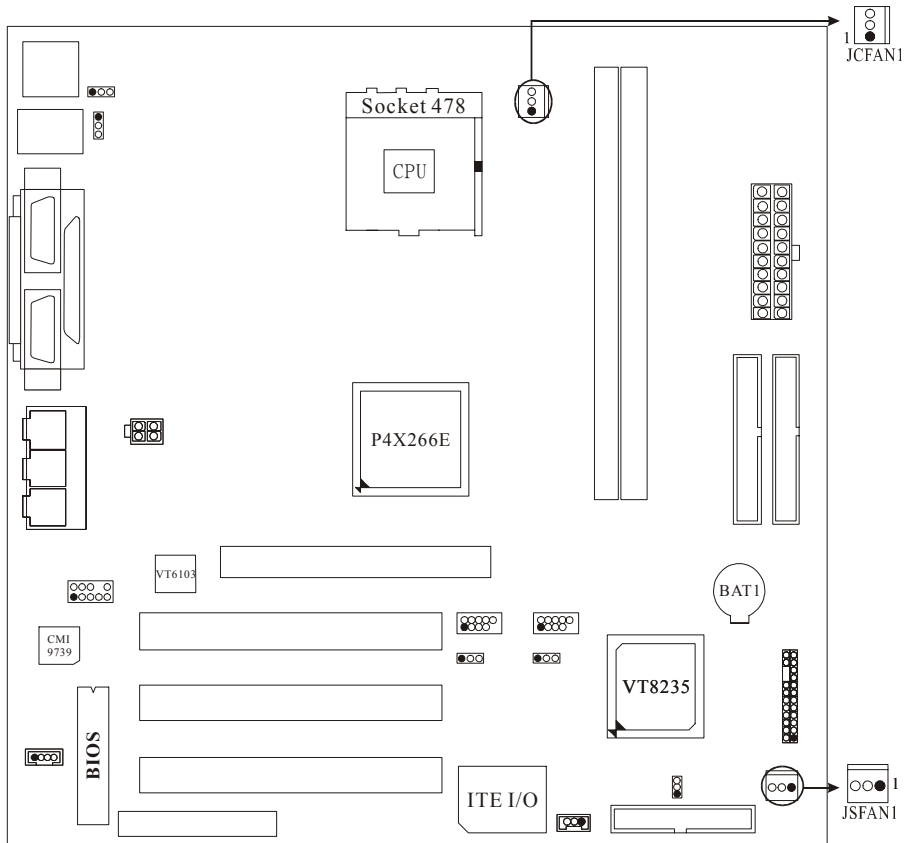

**3-2. CPU Fan Header: JCFAN1**

Pin No.	Assignment
1	Ground
2	+12V
3	Sense

**3-3. System Fan Header: JSFAN1**

<b>Pin No.</b>	<b>Assignment</b>
<b>1</b>	Ground
<b>2</b>	+12V
<b>3</b>	Sense

## 4. Jumpers, Headers & Connectors

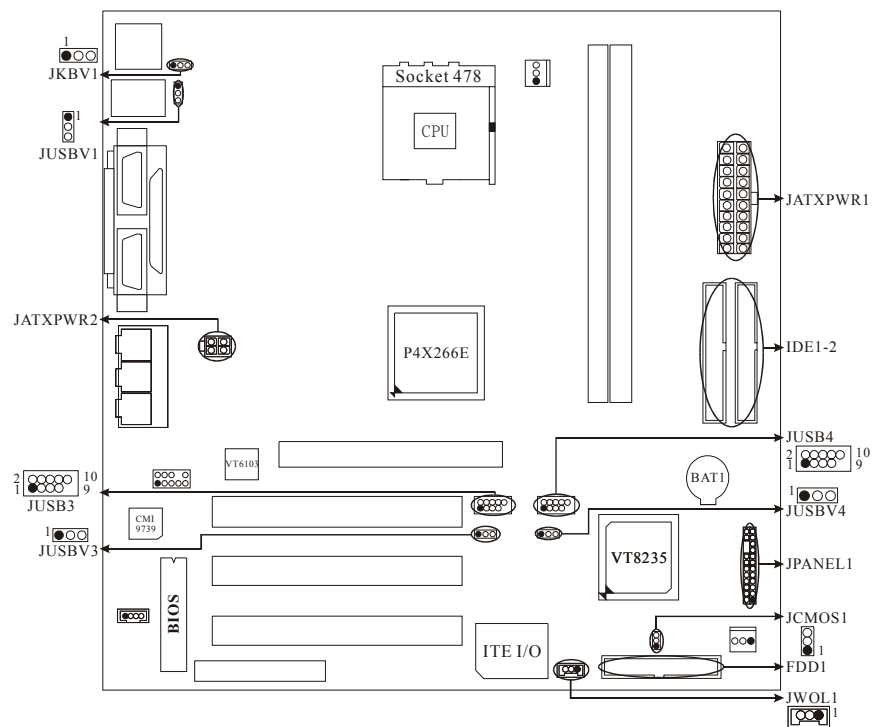

### 4-1. Front Panel Connector: JPANEL1

Pin No.	Assignment	Function	Pin No.	Assignment	Function
<b>1</b>	+5V	Speaker Connector	<b>2</b>	Sleep Control	Sleep Button
<b>3</b>	NA		<b>4</b>	Ground	
<b>5</b>	NA		<b>6</b>	NA	NA
<b>7</b>	Speaker		<b>8</b>	Power LED (+)	POWER LED
<b>9</b>	HDD LED (+)	<b>10</b>	Power LED (+)		
<b>11</b>	HDD LED (-)	<b>12</b>	Power LED (-)		
<b>13</b>	Ground	Reset Button	<b>14</b>	Power Button	Power-on Button
<b>15</b>	Reset Control		<b>16</b>	Ground	
<b>17</b>	NA		<b>18</b>	KEY	
<b>19</b>	NA	IrDA Connector	<b>20</b>	KEY	IrDA
<b>21</b>	VCC5		<b>22</b>	Ground	
<b>23</b>	IRTX		<b>24</b>	IRRX	

#### SPK (Speaker Connector)

An offboard speaker can be installed on the motherboard as a manufacturing option. An offboard speaker can be connected to the motherboard at the front panel connector. The speaker (onboard or offboard) provides error beep code information during the Power On Self-Test when the computer cannot use the video interface. The speaker is not connected to the audio subsystem and does not receive output from the audio subsystem.

#### RST (Reset Button)

This connector can be attached to a momentary SPST switch. This switch is usually open and when closed will cause the motherboard to reset and run the POST (Power On Self Test).



**POW-LED (Power LED Connector)**

This connector can be attached to an LED on the front panel of a computer case. The LED will illuminate while the computer is powered on.

**HLED (Hard Drive LED Connector)**

This connector can be attached to an LED on the front panel of a computer case. The LED will flicker during disk activity. This disk activity only applies to those IDE drives directly attached to the system board.

**IR (Infrared Connector)**

This connector is used to attach to an infrared sensing device. After the IrDA interface is configured, connectionless data transfer to and from portable devices such as laptops, PDAs is possible.

**SLP (Sleep/Green Button)**

This connector is used to conserve energy by powering down the monitor and the hard disk when not in use. To configure this option, you need to connect a button from the front panel to this connector. Depressing the button will power down the monitor and hard drives until the system is invoked by any keyboard activity, mouse activity, modem activity or when the sleep button is depressed again. APM (Advanced Power Management) must be enabled in the system BIOS and the APM driver must be loaded.

**ON/OFF (Power Button)**

This connector can be attached to a front panel power switch. The switch must pull the Power Button pin to ground for at least 50 ms to signal the power supply to switch on or off. (The time required is due to internal debounce circuitry on the system board). At least two seconds must pass before the power supply will recognize another on/off signal.

### 4-2. ATX 20-pin Power Connector: JATXPWR1

PIN	Assignment	PIN	Assignment
1	3.3V	11	3.3V
2	3.3V	12	-12V
3	Ground	13	Ground
4	5V	14	PS_ON
5	Ground	15	Ground
6	5V	16	Ground
7	Ground	17	Ground
8	PW_OK	18	-5V
9	5V_SB	19	5V
10	12V	20	5V

### 4-3. Hard Disk Connectors: IDE1/IDE2

This mainboard has a 32-bit Enhanced PCI IDE Controller that provides PIO Mode 0~4, Bus Master, and Ultra DMA / 33, Ultra DMA / 66, Ultra DMA / 100, and Ultra DMA / 133 functionality. It has two HDD connectors IDE1 (primary) and IDE2 (secondary).

- **IDE1 (Primary IDE Connector)**

The first hard drive should always be connected to IDE1. IDE1 can connect a Master and a Slave drive. You must configure the second hard drive on IDE1 to Slave mode by setting the jumper accordingly.

- **IDE2 (Secondary IDE Connector)**

The IDE2 controller can also support a Master and a Slave drive. The configuration is similar to IDE1. The second drive on this controller must be set to slave mode.



#### 4-4. Floppy Disk Connector: FDD1

The motherboard provides a standard floppy disk connector (FDC) that supports 360K, 720K, 1.2M, 1.44M and 2.88M floppy disk types. This connector supports the provided floppy drive ribbon cables.

#### 4-5. Wake On LAN Header: JWOL1

Pin No.	Assignment
1	5V SB
2	Ground
3	Wake up

#### 4-6. Clear CMOS Jumper: JCMOS1

JCMOS1	Assignment
1  3 1-2 Closed	Normal Operation (default)
1  3 2-3 Closed	Clear CMOS Data



The following procedures are for resetting the BIOS password. It is important to follow these instructions closely.

#### ※ Clear CMOS Procedures:

1. Remove AC power line.
2. Make JCMOS1 (2-3) closed.

3. Wait for five seconds.
4. Make JCMOS1 (1-2) closed.
5. Let AC power on.
6. Reset your desired password or clear the CMOS data.

#### 4-7. Front USB Header: JUSB3

(JUSB3)



Pin	Assignment	Pin	Assignment
1	+5V(fused)	2	+5V(fused)
3	USBP2-	4	USBP3-
5	USBP2+	6	USBP3+
7	Ground	8	Ground
9	KEY	10	NC

#### 4-8. Front USB Header: JUSB4

(JUSB4)

Pin	Assignment	Pin	Assignment
1	+5V(fused)	2	+5V(fused)
3	USBP2-	4	USBP3-
5	USBP2+	6	USBP3+
7	Ground	8	Ground
9	KEY	10	NC

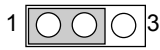

#### 4-9. 5V / 5VSB Selection for KB: JKBV1

JKBV1	Assignment
 1-2 Closed	5V
 2-3 Closed	5V_SB



**4-10. ATX 12V Power Connector: JATXPWR2**

PIN	Assignment	PIN	Assignment
1	12V	3	Ground
2	12V	4	Ground



**4-11. 5V / 5VSB Selection for USB: JUSBV1**

JUSBV1	Assignment
1  3 1-2 Closed	5V
1  3 2-3 Closed	5V_SB

**4-12. 5V / 5VSB Selection for USB: JUSBV3**

JUSBV3	Assignment
1  3 1-2 Closed	5V
1  3 2-3 Closed	5V_SB

**4-13. 5V / 5VSB Selection for USB: JUSBV4**

JUSBV4	Assignment
1  3 1-2 Closed	5V
1  3 2-3 Closed	5V_SB

## 5. RAM Module Configuration

### 5-1. DDR SDRAM

DRAM Access Time: 2.5V Unbuffered DDR SDRAM  
 PC1600/ PC2100 Type required.  
 DRAM Type: 128MB/ 256MB/ 512MB/ 1GB DIMM  
 Module (184 pin)

### Total Memory Size with unbuffer DIMMs

(Only for reference)

DIMM Socket Location	DDR Module	Total Memory Size (MB)
DDR 1	64MB/128MB/256MB/512MB/1GB *1	Max is 2GB
DDR 2	64MB/128MB/256MB/512MB/1GB *1	

## 5-2. How to install DDR DIMM Module

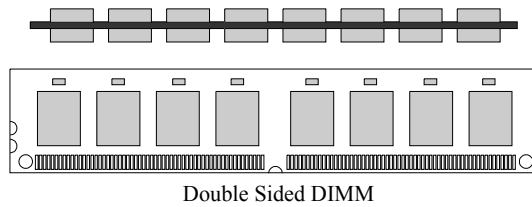
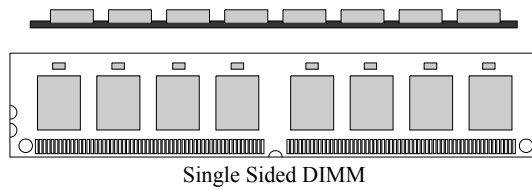

1. The DDR DIMM socket has a "Plastic Safety Tab", and the DDR DIMM memory module has an Asymmetrical notch", so the DDR DIMM memory module can only fit into the slot in one direction.

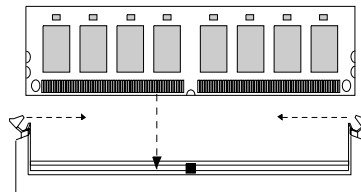

2. Push the tabs out. Insert the DDR DIMM memory modules into the socket at a 90-degree angle, then push down vertically so that it will fit into the place.

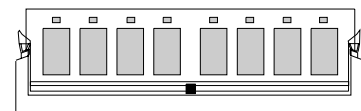

3. The Mounting Holes and plastic tabs should fit over the edge and hold the DDR DIMM memory modules in place.

## 6. Peripheral Port Features

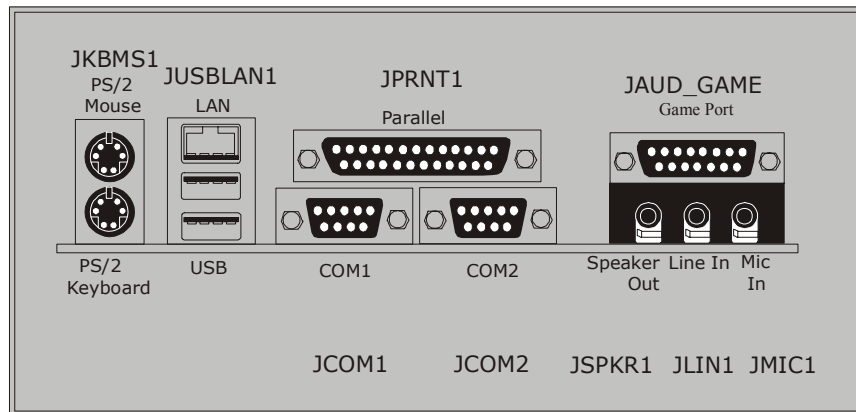

### 6-1. PS/2 Mouse / Keyboard Connector: JKBMS1

The motherboard provides a standard PS/2 mouse / Keyboard mini DIN connector for attaching a PS/2 mouse. You can plug a PS/2 mouse / Keyboard directly into this connector. The connector location and pin definition are shown below:

#### PS/2 Mouse / Keyboard Connectors

Pin	Assignment
1	Data
2	No connect
3	Ground
4	+5 V (fused)
5	Clock
6	No connect



## 6-2. USB & LAN Port Connectors: JUSBLAN1

### 6-2-1. USB Connectors:

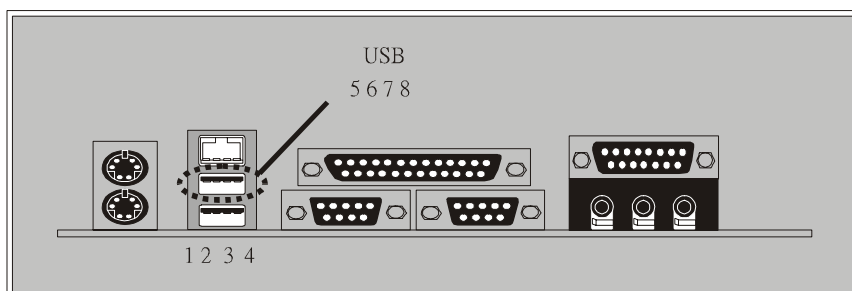

#### USB Connector (the below one)

Pin	Assignment
1	+5 V (fused)
2	USBP1-
3	USBP1+
4	Ground

#### USB Connector (the above one)

Pin	Assignment
5	+5 V (fused)
6	USBP2-
7	USBP2+
8	Ground

### 6-2-2. LAN Port Connector

This connector allows you to connect to the Internet through a Local Area Network (LAN). You can set up the connection by entering account information provided by your ISP.

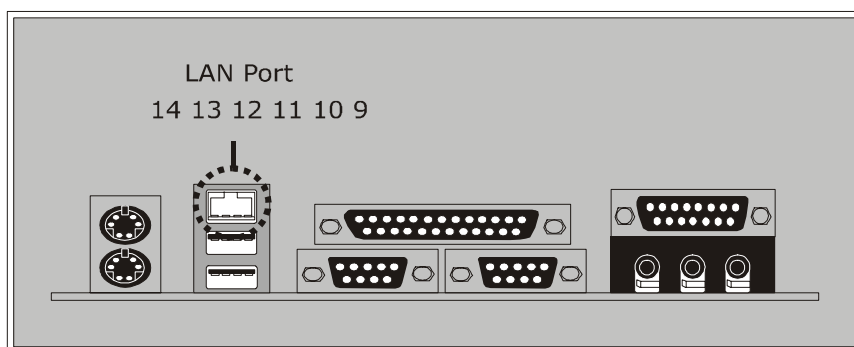

**LAN Port Connector**

Pin	Assignment
9	VCC3
10	TD+
11	TD-
12	RD+
13	RD-
14	NC

## 6-3. Serial and Parallel Interface Ports

This system comes equipped with two serial ports and one parallel port. Both types of interface ports will be explained in this chapter.

### 6-3-1. The Serial Interface: JCOM1/JCOM2

The serial interface port is sometimes referred to as an RS-232 port or an asynchronous communication port. Mice, printers, modems and other peripheral devices can be connected to a serial port. The serial port can also be used to connect your computer with another computer system.

#### Connectivity

The serial ports can be used in many ways, and it may be necessary to become familiar with the pinout diagram. The following chart gives you the function of each pin on the 9-pin connector and some of the 25-pin connector. This information can be used when configuring certain software programs to work with the serial ports.

Signal	Name	DB9 PIN	DB25 PIN
DCD	Data Carrier Detect	1	8
RX	Receive Data	2	3
TX	Transmit Data	3	2
DTR	Data Terminal Ready	4	20
GND	Signal Ground	5	7
DSR	Data Set Ready	6	6
RTS	Request to Send	7	4
CTS	Clear to Send	8	5
RI	Ring Indicator	9	22

**6-3-2. Parallel Interface Port: JPRNT1**

Unlike the serial ports, parallel interface port has been standardized and should not present any difficulty interfacing peripherals to your system. Sometimes called centronics port, the parallel port is almost exclusively used with printers. The parallel port on your system has a 25-pin, DB25 connector. The pinout for the parallel port are shown in the table below.

<b>Pin</b>	<b>Signal</b>
1	-Strobe
2	Data 0
3	Data 1
4	Data 2
5	Data 3
6	Data 4
7	Data 5
8	Data 6
9	Data 7
10	-Ack
11	Busy
12	Paper Empty
13	+Select
14	-Auto FDXT
15	-Error
16	-Init
17	-SLCTN
18	Ground
19	Ground
20	Ground
21	Ground
22	Ground
23	Ground
24	Ground
25	Ground

#### 6-4. Game (Joystick/MIDI) Port Connector: JAUD\_GAME

This connector allows you to connect a joystick or game pad for playing computer games. Also, you may play or edit professional music by connecting MIDI devices.

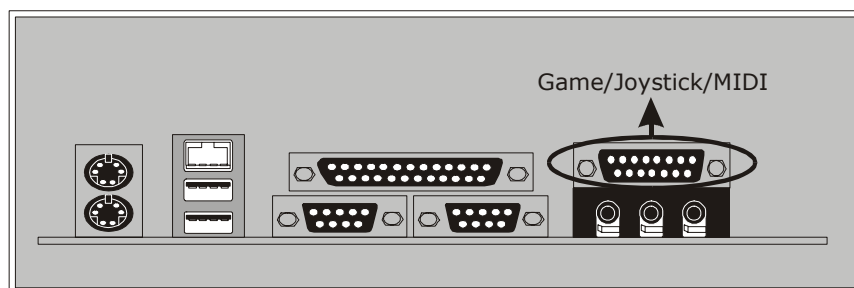

#### 6-5. Audio Port Connectors: JSPKR1/JLIN1/JMIC1

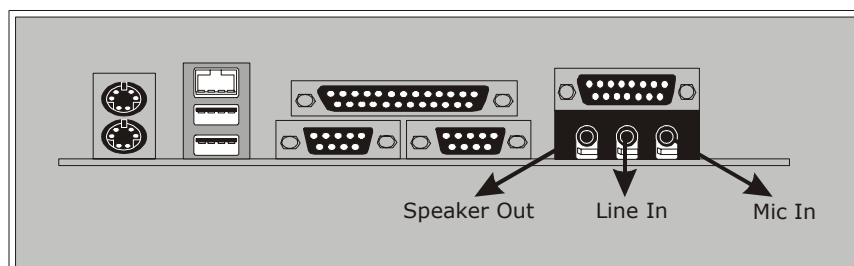

1. **Speaker Out** is used to connect speakers or headphones for audio output.
2. **Line In** can be connected to the external CD player, Tape player or other audio devices for audio input.
3. **Rear Speaker** can be connected to the rear speakers while

- four/six channel speakers mode is enabled.
- 4. **Mic In** is used to connect a microphone, which allows you to input sounds and voices.
  - 5. **Center and Bass** can be connected to center speaker and bass while six channel speakers mode is enabled.

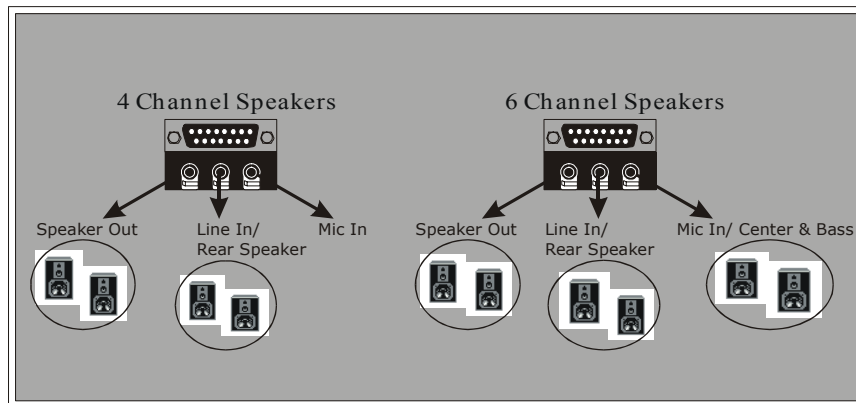

## 6-6. Audio Subsystem

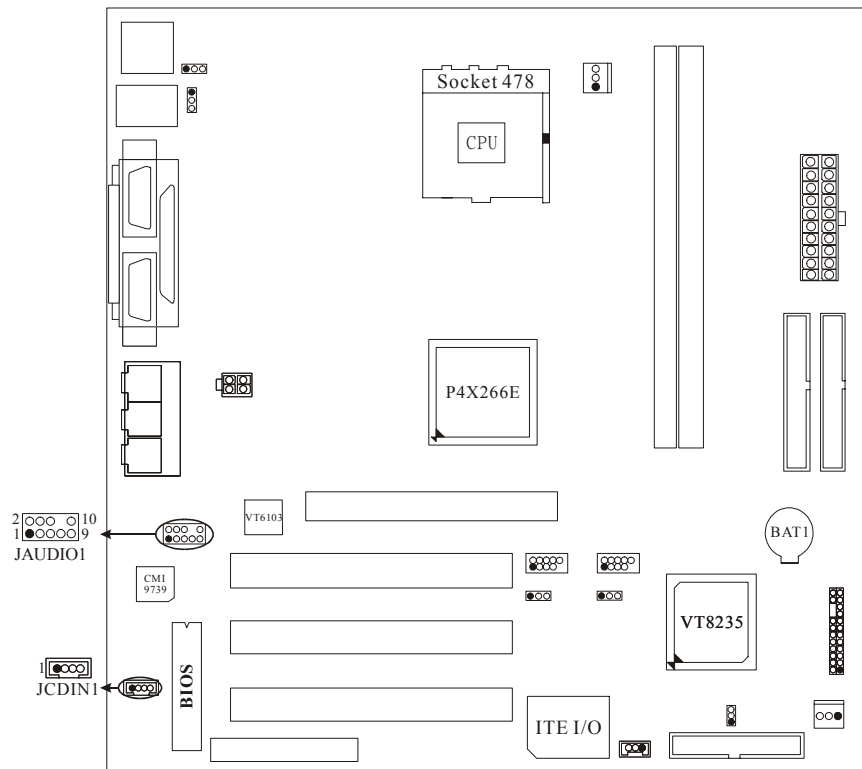

**6-6-1. CD-ROM Audio-In Header: JCDIN1**

Pin No.	Assignment
<b>1</b>	Left Channel Input
<b>2</b>	Ground
<b>3</b>	Ground
<b>4</b>	Right Channel Input

**6-6-2. Front Panel Audio Header: JAUDIO1**

Pin No.	Assignment	Pin No.	Assignment
<b>1</b>	Mic In	<b>2</b>	Ground
<b>3</b>	Mic Power	<b>4</b>	Audio Power
<b>5</b>	RT Line Out	<b>6</b>	RT Line Out
<b>7</b>	Reserved	<b>8</b>	
<b>9</b>	LFT Line Out	<b>10</b>	LFT Line Out



06/28/2002