

ASUS[®] TX97-N
Pentium[®] NLX Motherboard

USER'S MANUAL

USER'S NOTICE

No part of this manual, including the products and software described in it, may be reproduced, transmitted, transcribed, stored in a retrieval system, or translated into any language in any form or by any means, except documentation kept by the purchaser for backup purposes, without the express written permission of ASUSTeK COMPUTER INC. ("ASUS").

ASUS PROVIDES THIS MANUAL "AS IS" WITHOUT WARRANTY OF ANY KIND, EITHER EXPRESS OR IMPLIED, INCLUDING BUT NOT LIMITED TO THE IMPLIED WARRANTIES OR CONDITIONS OF MERCHANTABILITY OR FITNESS FOR A PARTICULAR PURPOSE. IN NO EVENT SHALL ASUS, ITS DIRECTORS, OFFICERS, EMPLOYEES OR AGENTS BE LIABLE FOR ANY INDIRECT, SPECIAL, INCIDENTAL, OR CONSEQUENTIAL DAMAGES (INCLUDING DAMAGES FOR LOSS OF PROFITS, LOSS OF BUSINESS, LOSS OF USE OR DATA, INTERRUPTION OF BUSINESS AND THE LIKE), EVEN IF ASUS HAS BEEN ADVISED OF THE POSSIBILITY OF SUCH DAMAGES ARISING FROM ANY DEFECT OR ERROR IN THIS MANUAL OR PRODUCT.

Product warranty or service will not be extended if: (1) the product is repaired, modified or altered, unless such repair, modification or alteration is authorized in writing by ASUS; or (2) the serial number of the product is defaced or missing.

Products and corporate names appearing in this manual may or may not be registered trademarks or copyrights of their respective companies, and are used only for identification or explanation and to the owners' benefit, without intent to infringe.

- Intel, LANDesk, and Pentium are registered trademarks of Intel Corporation.
- IBM and OS/2 are registered trademarks of International Business Machines.
- Symbios is a registered trademark of Symbios Logic Corporation.
- Windows and MS-DOS are registered trademarks of Microsoft Corporation.
- Sound Blaster AWE32 and SB16 are trademarks of Creative Technology Ltd.
- Adobe and Acrobat are registered trademarks of Adobe Systems Incorporated.

The product name and revision number are both printed on the product itself. Manual revisions are released for each product design represented by the digit before and after the period of the manual revision number. Manual updates are represented by the third digit in the manual revision number.

For previous or updated manuals, BIOS, drivers, or product release information, contact ASUS at <http://www.asus.com.tw> or through any of the means indicated on the following page.

SPECIFICATIONS AND INFORMATION CONTAINED IN THIS MANUAL ARE FURNISHED FOR INFORMATIONAL USE ONLY, AND ARE SUBJECT TO CHANGE AT ANY TIME WITHOUT NOTICE, AND SHOULD NOT BE CONSTRUED AS A COMMITMENT BY ASUS. ASUS ASSUMES NO RESPONSIBILITY OR LIABILITY FOR ANY ERRORS OR INACCURACIES THAT MAY APPEAR IN THIS MANUAL, INCLUDING THE PRODUCTS AND SOFTWARE DESCRIBED IN IT.

Copyright © 1998 ASUSTeK COMPUTER INC. All Rights Reserved.

Product Name:	ASUS TX97-N
Manual Revision:	1.04
Release Date:	January 1998

ASUS CONTACT INFORMATION

ASUSTeK COMPUTER INC.

Marketing Info

Address: 150 Li-Te Road, Peitou, Taipei, Taiwan 112, ROC
Telephone: +886-2-2894-3447
Fax: +886-2-2894-3449
Email: info@asus.com.tw

Technical Support

Fax: +886-2-2895-9254
BBS: +886-2-2896-4667
Email: tsd@asus.com.tw
WWW: www.asus.com.tw
Gopher: gopher.asus.com.tw
FTP: ftp.asus.com.tw/pub/ASUS

ASUS COMPUTER INTERNATIONAL

Marketing Info

Address: 721 Charcot Avenue, San Jose, CA 95131, USA
Telephone: +1-408-474-0567
Fax: +1-408-474-0568
Email: info-usa@asus.com.tw

Technical Support

BBS: +1-408-474-0569
Email: tsd-usa@asus.com.tw
WWW: www.asus.com

ASUS COMPUTER GmbH

Marketing Info

Address: Harkort Str. 25, 40880 Ratingen, BRD, Germany
Telephone: 49-2102-445011
Fax: 49-2102-442066
Email: info-ger@asus.com.tw

Technical Support

Hotline: 49-2102-499712
BBS: 49-2102-448690
Email: tsd-ger@asus.com.tw
WWW: www.asuscom.de
FTP: ftp.asuscom.de/pub/ASUSCOM

CONTENTS

I. INTRODUCTION	7
How this manual is organized	7
Item Checklist	7
II. FEATURES	8
Features of the ASUS TX97-N Motherboard	8
Parts of the ASUS TX97-N Motherboard	9
Riser Card Front	9
Riser Card Back	9
III. INSTALLATION	10
ASUS TX97-N Motherboard Layout	10
Installation Steps	12
1. Jumpers	12
Jumper Settings	13
2. System Memory (DIMM)	17
DIMM Memory Installation Procedures:	18
3. Central Processing Unit (CPU)	19
4. Expansion Cards	20
Expansion Card Installation Procedure:	20
Assigning IRQs for Expansion Cards	20
Assigning DMA Channels for ISA Cards	21
ISA Cards and Hardware Monitor	21
5. External Connectors	22
Front Panel Descriptions	27
Power Connection Procedures	31
Main Menu	32
Support Software	32
Flash Memory Writer Utility	32
Advanced Features Menu	33
Managing and Updating Your Motherboard's BIOS	34
6. BIOS Setup	35
Load Defaults	36
Standard CMOS Setup	36
Details of Standard CMOS Setup:	37
BIOS Features Setup	39
Details of BIOS Features Setup	39
Chipset Features Setup	41
Details of Chipset Features Setup	41
Power Management Setup	44
Details of Power Management Setup	44

CONTENTS

PNP and PCI Setup	46
Details of PNP and PCI Setup	46
Load BIOS Defaults	48
Load Setup Defaults	48
Supervisor Password and User Password	49
IDE HDD Auto Detection	50
Save and Exit Setup	51
Exit Without Saving	51
V. SUPPORT SOFTWARE	52
Desktop Management Interface (DMI)	52
Introducing the ASUS DMI Configuration Utility	52
System Requirements	52
Using the ASUS DMI Configuration Utility	53
Notes	53
VI. ASUS PCI SCSI Cards	55
Symbios SCSI BIOS and Drivers	55
ASUS PCI-SC200 & PCI-SC860 SCSI Cards	55
Setting Up the ASUS PCI-SC200 & PCI-SC860	56
Setting the INT Assignment for the ASUS PCI-SC200	56
Terminator Requirements for SCSI Devices	56
Terminator Settings for the ASUS PCI-SC860	57
Terminator Settings for the ASUS PCI-SC200	57
SCSI ID Numbers for SCSI Devices	58
SCSI ID Priority	58
VII. ASUS LAN Card	59
ASUS PCI-L101 Fast Ethernet Card	59
Features	60
Drivers Supported	60
Question and Answer	60

FCC & DOC COMPLIANCE

Federal Communications Commission Statement

This device complies with FCC Rules Part 15. Operation is subject to the following two conditions:

- This device may not cause harmful interference, and
- This device must accept any interference received, including interference that may cause undesired operation.

This equipment has been tested and found to comply with the limits for a Class B digital device, pursuant to Part 15 of the FCC Rules. These limits are designed to provide reasonable protection against harmful interference in a residential installation. This equipment generates, uses and can radiate radio frequency energy and, if not installed and used in accordance with manufacturer's instructions, may cause harmful interference to radio communications. However, there is no guarantee that interference will not occur in a particular installation. If this equipment does cause harmful interference to radio or television reception, which can be determined by turning the equipment off and on, the user is encouraged to try to correct the interference by one or more of the following measures:

- Re-orient or relocate the receiving antenna.
- Increase the separation between the equipment and receiver.
- Connect the equipment to an outlet on a circuit different from that to which the receiver is connected.
- Consult the dealer or an experienced radio/TV technician for help.

WARNING! The use of shielded cables for connection of the monitor to the graphics card is required to assure compliance with FCC regulations. Changes or modifications to this unit not expressly approved by the party responsible for compliance could void the user's authority to operate this equipment.

Canadian Department of Communications Statement

This digital apparatus does not exceed the Class B limits for radio noise emissions from digital apparatus set out in the Radio Interference Regulations of the Canadian Department of Communications.

I. INTRODUCTION

How this manual is organized

This manual is divided into the following sections:

- I. Introduction:** Manual information and checklist
- II. Features:** Information and specifications concerning this product
- III. Installation:** Instructions on setting up the motherboard
- IV. BIOS Software:** Instructions on setting up the BIOS software
- V. Support Software:** Information on the included support software
- VI. ASUS SCSI Cards:** Installation of ASUS SCSI cards (optional)
- VII. ASUS L101 Card:** Installation of the ASUS LAN card (optional)

Item Checklist

Please check that your package is complete. If you discover damaged or missing items, please contact your retailer.

- (1) ASUS motherboard
- (1) IDE ribbon cable for master and slave drives
- (1) Floppy ribbon cable for one 3.5inch floppy drive
- (1) Support drivers and utilities
- (1) Motherboard User's Manual
- (1) System housing User's Manual

- (1) NLX Form-factor system housing, riser card, and power supply
- DIMM memory module
- 3.5inch Floppy Drive
- Slim CD-ROM and cable
- ASUS PCI-SC200 Fast-SCSI or PCI-SC860 Ultra-Fast SCSI card (optional)
- ASUS PCI-L101 Wake-on-LAN 10/100 Ethernet Card (optional)

II. FEATURES

Features of the ASUS TX97-N Motherboard

The ASUS TX97-N motherboard is carefully designed for the demanding PC user who wants many features in a small package, namely:

- **Mini NLX:** Features ASUS' custom designed mini-NLX form factor.
- **Intel Chipset:** Features Intel's 430TX PCIset.
- **Onboard VGA:** Has ATI 3D Rage VGA onboard with 1MB upgradable to 2MB.
- **Onboard Audio:** Has Yamaha 16-bit audio onboard.
- **LCD Support:** Supports a LCD panel as an alternative to a bulky monitor.
- **Slim CD-ROM:** Supports a notebook-sized slim CD-ROM drive.
- **Wake on LAN:** Supports wake on LAN activity with special network cards.
- **Versatile Processor Support:** Intel Pentium® 75–233MHz (P55C-MMX™, P54C/P54CS), IBM®/Cyrix® 6x86-PR166+ (Rev 2.7 or later), IBM®/Cyrix® 6x86MX™ (PR166 & faster), AMD-K5™ (PR75–PR133), AMD-K6™ (PR166 & faster).
- **Versatile Memory Support:** Is equipped with two DIMM sockets to support 8-128MB 168-pin 3.3Volt SDRAM/EDO memory modules up to 256MB.
- **ISA & PCI Expansion Slots:** Provides one 16-bit ISA slot & two 32-bit PCI slots
- **Super Multi-I/O:** Provides an onboard I/O processor for two high-speed UART-compatible serial ports and one parallel port with EPP and ECP capabilities.
- **Level 2 Cache:** Comes with onboard 512K Pipelined Burst SRAM.
- **Onboard IrDA:** Has an infrared port on the riser card for wireless interface.
- **Desktop Management Interface (DMI):** Supports DMI through BIOS, which allows hardware to communicate within a standard protocol creating a higher level of compatibility. (Requires DMI-enabled components.) (See section V)
- **PCI Bus Master IDE Controller:** Has onboard Ultra DMA/33 Bus Master IDE controller with two connectors (one for CD-ROM only). Supports two IDE devices up to 8.4GB using one channel. Supports Bus Master UltraDMA/33 IDE, PIO Modes 3 & 4, and Bus Master IDE DMA Mode 2. Includes integrated keyboard controller. Supports two of either 5.25-inch (360KB, 1.2KB) or 3.5-inch disk drives (720KB, 1.44MB, 2.88MB). Supports Japanese "Floppy 3 mode" (3.5-inch disk drive: 1.2MB) and LS-120 floppy disk drives (3.5-inch disk drive: 120 MB, 1.44MB, 720K). BIOS supports IDE CD-ROM or SCSI device bootup.
- **TV Out:** Supports optional onboard TV out function using ImpacTV chipset.
- **Symbios SCSI BIOS:** Supports optional ASUS SCSI controller cards through onboard firmware.
- **Performance:** Provides 528MB/s data transfer rate using SDRAM, 33MB/s IDE transfer rate using Bus Master UltraDMA/33 IDE, concurrent PCI allows multiple PCI transfers
- **Compliance:** Is ACPI ready for advanced power management features and PC'97 for greater support.
- **Easy Installation:** Incorporates BIOS that supports autodetection of hard disk drives, PS/2 mouse, and Plug and Play devices to make setup of hard disk drives, expansion cards, and other devices virtually automatic.
- **Riser Card:** Provides NLX power, primary IDE, floppy drive, LAN wake up connector, 2 PCI slots, 1 ISA slot, 2 USB ports, and IrDA.

II. FEATURES

Parts of the ASUS TX97-N Motherboard

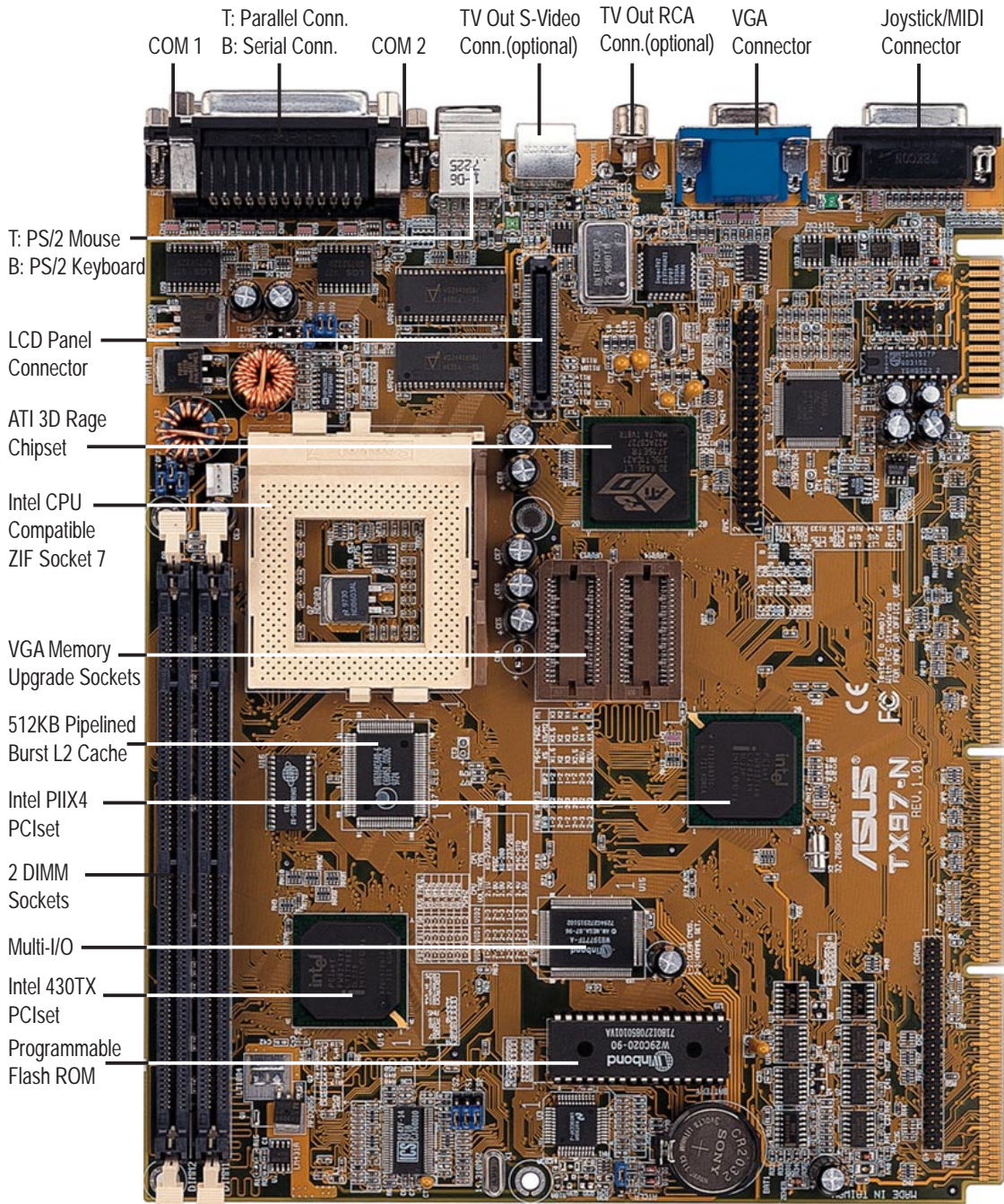

II. FEATURES
(Motherboard Parts)

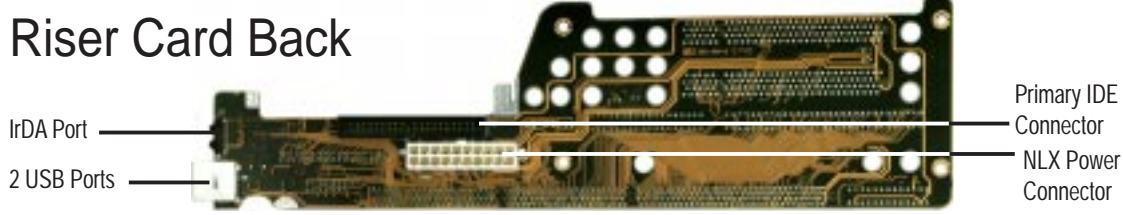

III. INSTALLATION

ASUS TX97-N Motherboard Layout

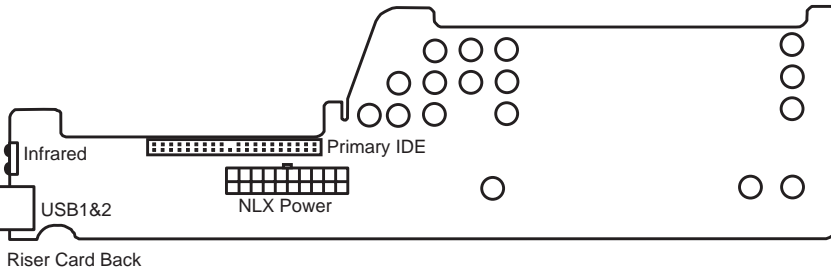
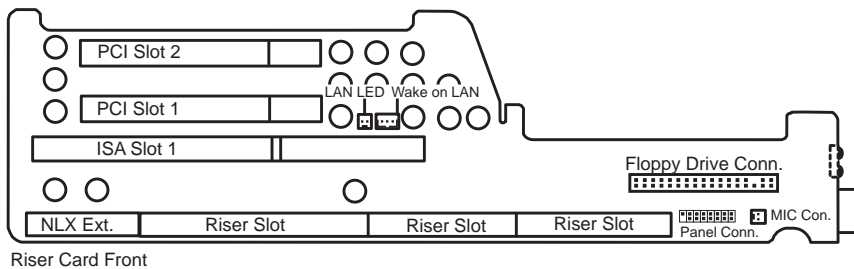
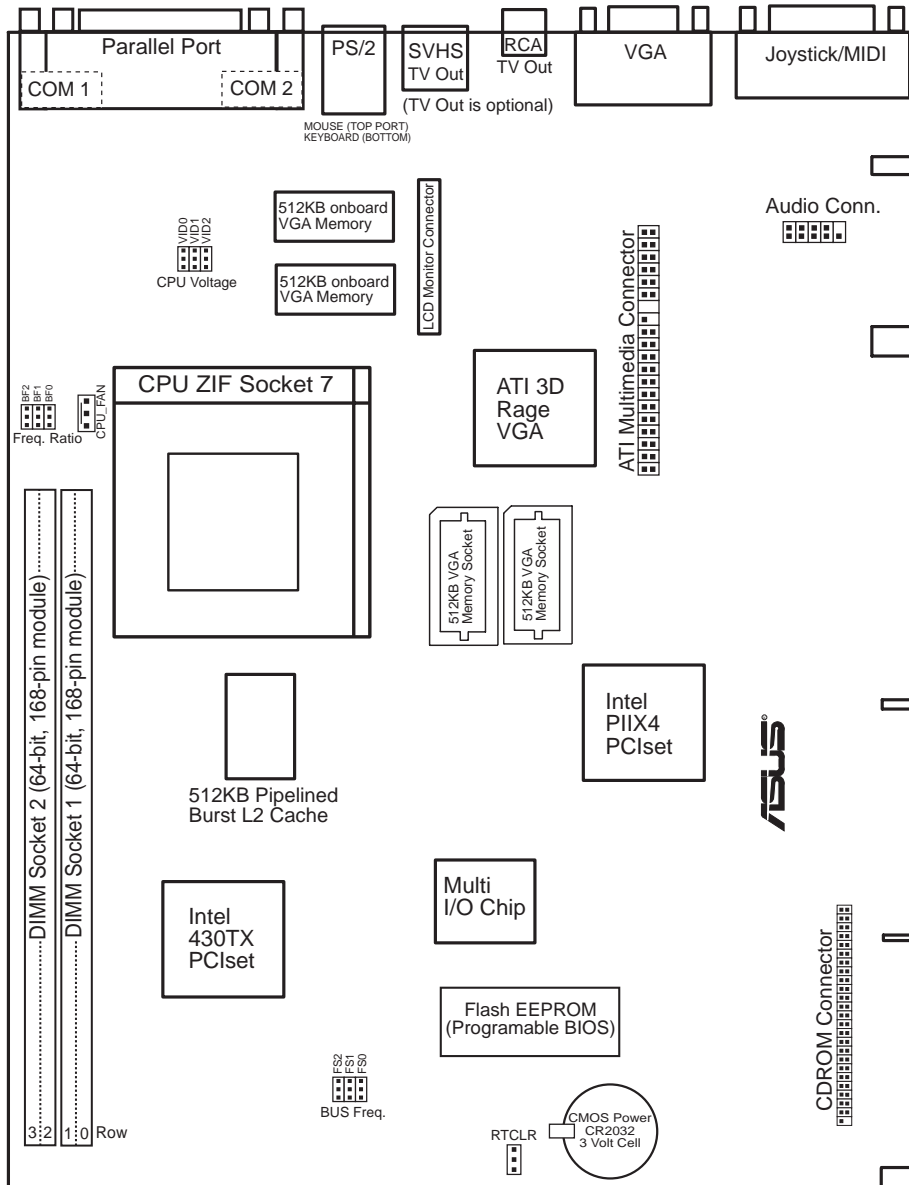

III. INSTALLATION
(Motherboard Layout)

III. INSTALLATION

Jumpers

- | | | |
|------------------|-------|--|
| 1) RTCLR | p. 13 | Real Time Clock RAM (Operation/Clear Data) |
| 2) BF0, BF1, BF2 | p. 14 | CPU:BUS Frequency Ratio |
| 3) FS0, FS1, FS2 | p. 14 | CPU External Clock (BUS) Frequency Selection |
| 4) VID0, 1, 2 | p. 16 | CPU Voltage Regulator Output Selection |

Expansion Slots

- | | | |
|---------------------|-------|---------------------------------------|
| 1) DIMM Sockets | p. 17 | 168-Pin DIMM Memory Expansion Sockets |
| 2) CPU ZIF Socket 7 | p. 19 | Central Processing Unit (CPU) Socket |
| 3) SLOT 1 | p. 20 | 16-bit ISA Bus Expansion Slots |
| 4) PCI 1, 2 | p. 20 | 32-bit PCI Bus Expansion Slots |

Connectors

- | | | |
|----------------------|-------|---|
| 1) PS2KEYBOARD | p. 22 | PS/2 Keyboard Connector (6-pin Female) |
| 2) PS2MOUSE | p. 22 | PS/2 Mouse Connector (6-pin Female) |
| 3) GAME_PORT | p. 22 | Joystick or MIDI Connector (15-pin Female) |
| 4) PRINTER | p. 23 | Parallel (Printer) Port Connector (25-pin Female) |
| 5) COM1, COM2 | p. 23 | Serial Port COM1 and COM2 (Two 9-pin Male) |
| 6) VGA | p. 23 | VGA Compatible Connector (15-pin Female) |
| 7) TV Out (optional) | p. 23 | Television Connector (RCA & 4-pin Female S-Video) |
| 8) USB | p. 24 | Universal Serial BUS Ports 1 & 2 (Two 4-pin Female) |
| 9) IR | p. 24 | Infrared Module |
| 10) POWER | p. 24 | NLX Motherboard Power Connector (20-pin Block) |
| 11) IDE1 | p. 25 | Primary IDE Connector (40-pin Block) |
| 12) FLOPPY | p. 25 | Floppy Drive Connector (34-pin Block) |
| 13. LAN_LED, WOL_ | p. 25 | LAN Activity Connectors (2-pin & 3-pin) |
| 14) PAN_CON | p. 26 | Front Panel Display LEDs and Switches (16-1 pin) |
| 15) MIC_CON | p. 26 | Front Panel Microphone Jack Connector (2 pin) |
| 16) AMC | p. 28 | ATI Multimedia Connector (40-3 pin Block) |
| 17) AUDIO | p. 28 | Back Panel Audio Connectors (10-1 pin Block) |
| 18) CPU_FAN | p. 28 | CPU Fan Power (3-pin Block) |
| 19) VGA Memory | p. 29 | Onboard VGA Memory Expansion Sockets (40 pins) |
| 20) CDROM | p. 29 | CD-ROM Drive Connector (50-1 pins) |





III. INSTALLATION

Installation Steps

Before using your computer, you must complete the following steps:

1. **Set Jumpers on the Motherboard**
2. **Install System Memory**
3. **Install the Central Processing Unit (CPU)**
4. **Install Expansion Cards**
5. **Connect Ribbon Cables, Cabinet Wires, and Power Supply**
6. **Setup the BIOS Software**

1. Jumpers

Several hardware settings are made through the use of jumper caps to connect jumper pins (JP) on the motherboard. See “Motherboard Layout” for locations of jumpers. The jumper settings will be described numerically such as [---], [1-2], [2-3] for no connection, connect pins 1&2, and connect pins 2&3 respectively. A “1” is written besides pin 1 on jumpers with three pins. The jumpers will also be shown graphically such as  to connect pins 1&2 and  to connect pins 2&3. Jumpers with two pins will be shown as  for Short (On) and  for Open (Off). For manufacturing simplicity, the jumpers may be sharing pins from other groups. Use the diagrams in this manual instead of following the pin layout on the board. Settings with two jumper numbers require that both jumpers be moved together. To connect the pins, simply place a plastic jumper cap over the two pins as diagramed.

WARNING! Computer motherboards, baseboards and components, such as SCSI cards, contain very delicate Integrated Circuit (IC) chips. To protect them against damage from static electricity, you should follow some precautions whenever you work on your computer.

1. Unplug your computer when working on the inside.
2. Use a grounded wrist strap before handling computer components. If you do not have one, touch both of your hands to a safely grounded object or to a metal object, such as the power supply case.
3. Hold components by the edges and try not to touch the IC chips, leads or connectors, or other components.
4. Place components on a grounded antistatic pad or on the bag that came with the component whenever the components are separated from the system.

III. INSTALLATION

Jumper Settings

1. Real Time Clock (RTC) RAM (RTCLR)

The CMOS RAM is powered by the onboard button cell battery. To clear the RTC data: (1) Turn off your computer and remove the AC power, (2) Move this jumper to “Clear Data,” (3) Move the jumper back to “Operation,” (4) Turn on your computer, (5) Hold down <Delete> during bootup and enter BIOS setup to re-enter user preferences.

Battery Test Jumper (RTCLR)

You can test the battery’s current by removing this jumper and attaching a current meter to the “Operation” pins.

WARNING! You must unplug the power cord to your power supply to ensure that there is no power to your motherboard. The CMOS RAM containing BIOS setup information *may* be cleared by this action. You *should* enter BIOS to “Load Setup Defaults” and re-enter any user information after removing and reapplying this jumper.

<u>RTC RAM</u>	<u>RTCLR</u>
Operation	[2-3] (Default)
Clear Data	[1-2] (momentarily)

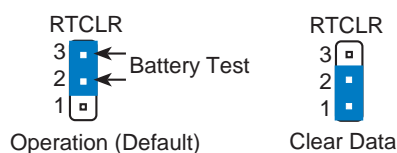
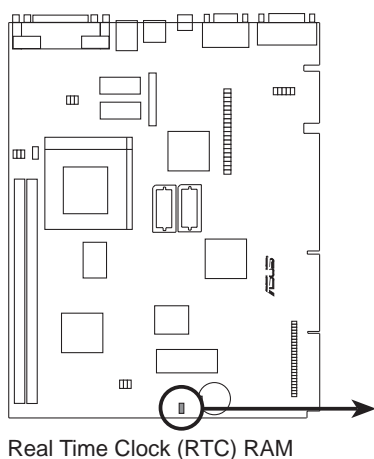

III. INSTALLATION

2. CPU to BUS Frequency Ratio (BF0, BF1, BF2)

These jumpers set the frequency ratio between the *Internal* frequency of the CPU and the *External* frequency (called the *BUS Clock*) within the CPU. These must be set together with the above jumpers *CPU External (BUS) Frequency Selection*.

3. CPU External (BUS) Frequency Selection (FS0, FS1, FS2)

These jumpers tell the clock generator what frequency to send to the CPU. These allow the selection of the CPU's *External* frequency (or *BUS Clock*). The *BUS Clock* times the *BUS Ratio* equals the CPU's *Internal* frequency (the advertised CPU speed).

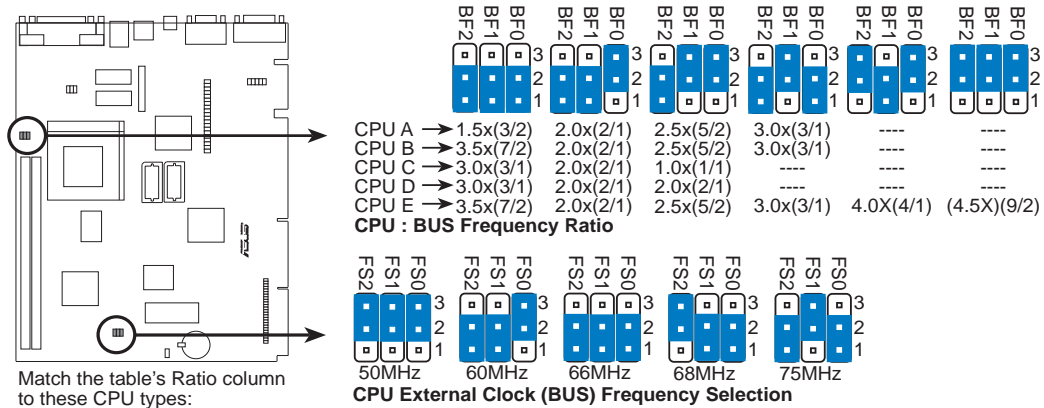

WARNING! Frequencies above 66MHz exceed the specifications for the onboard Intel Chipset and are not guaranteed to be stable.

III. INSTALLATION

Set the jumpers by the Internal speed of the Intel, AMD, IBM, or Cyrix CPU as follows:

CPU Model	Freq.	Ratio	BUS F.	(BUS Freq.)			(Freq. Ratio)		
				FS2	FS1	FS0	BF2	BF1	BF0
Intel Pentium P54C	166MHz	A-2.5x	66MHz	[1-2]	[1-2]	[1-2]	[1-2]	[2-3]	[2-3]
Intel Pentium P54C	150MHz	A-2.5x	60MHz	[1-2]	[1-2]	[2-3]	[1-2]	[2-3]	[2-3]
Intel Pentium P54C	133MHz	A-2.0x	66MHz	[1-2]	[1-2]	[1-2]	[1-2]	[1-2]	[2-3]
Intel Pentium P54C	120MHz	A-2.0x	60MHz	[1-2]	[1-2]	[2-3]	[1-2]	[1-2]	[2-3]
Intel Pentium P54C	100MHz	A-1.5x	66MHz	[1-2]	[1-2]	[1-2]	[1-2]	[1-2]	[1-2]
Intel Pentium P54C	90MHz	A-1.5x	60MHz	[1-2]	[1-2]	[2-3]	[1-2]	[1-2]	[1-2]
Intel Pentium P54C	75MHz	A-1.5x	50MHz	[2-3]	[2-3]	[2-3]	[1-2]	[1-2]	[1-2]
AMD-K5-PR133	100MHz	A-1.5x	66MHz	[1-2]	[1-2]	[1-2]	[1-2]	[1-2]	[1-2]
AMD-K5-PR120	90MHz	A-1.5x	60MHz	[1-2]	[1-2]	[2-3]	[1-2]	[1-2]	[1-2]
AMD-K5-PR100	100MHz	A-1.5x	66MHz	[1-2]	[1-2]	[1-2]	[1-2]	[1-2]	[1-2]
AMD-K5-PR90	90MHz	A-1.5x	60MHz	[1-2]	[1-2]	[2-3]	[1-2]	[1-2]	[1-2]
AMD-K5-PR75	75MHz	A-1.5x	50MHz	[2-3]	[2-3]	[2-3]	[1-2]	[1-2]	[1-2]
Intel Pentium P55C	233MHz	B-3.5x	66MHz	[1-2]	[1-2]	[1-2]	[1-2]	[1-2]	[1-2]
Intel Pentium P55C	200MHz	B-3.0x	66MHz	[1-2]	[1-2]	[1-2]	[1-2]	[2-3]	[1-2]
Intel Pentium P55C	166MHz	B-2.5x	66MHz	[1-2]	[1-2]	[1-2]	[1-2]	[2-3]	[2-3]
IBM/Cyrix 6x86MX-PR233	200MHz	B-3.0x	66MHz	[1-2]	[1-2]	[1-2]	[1-2]	[2-3]	[1-2]
IBM/Cyrix 6x86MX-PR200	166MHz	B-2.5x	66MHz	[1-2]	[1-2]	[1-2]	[1-2]	[2-3]	[2-3]
IBM/Cyrix 6x86MX-PR166	150MHz	B-2.5x	60MHz	[1-2]	[1-2]	[2-3]	[1-2]	[2-3]	[2-3]
*IBM/Cyrix 6x86-PR166+	133MHz	C-2.0x	66MHz	[1-2]	[1-2]	[1-2]	[1-2]	[1-2]	[2-3]
*IBM/Cyrix 6x86L-PR166+	133MHz	D-2.0x	66MHz	[1-2]	[1-2]	[1-2]	[1-2]	[1-2]	[2-3]
AMD-K6-PR233	233MHz	E-3.5x	66MHz	[1-2]	[1-2]	[1-2]	[1-2]	[1-2]	[1-2]
AMD-K6-PR200	200MHz	E-3.0x	66MHz	[1-2]	[1-2]	[1-2]	[1-2]	[2-3]	[1-2]
AMD-K6-PR166	166MHz	E-2.5x	66MHz	[1-2]	[1-2]	[1-2]	[1-2]	[2-3]	[2-3]

III. INSTALLATION
(Jumpers)

***NOTE:** The only IBM/Cyrix 6x86(L) (or M1) that is supported on this motherboard is rev 2.7 or later. Look on the underside of the CPU for the serial number. The number should read G8DC6620A or later.

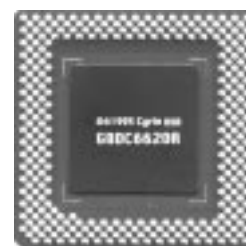

III. INSTALLATION

5. Voltage Regulator Output Selection (VID0, 1, 2)

These jumpers set the voltage supplied to the CPU.

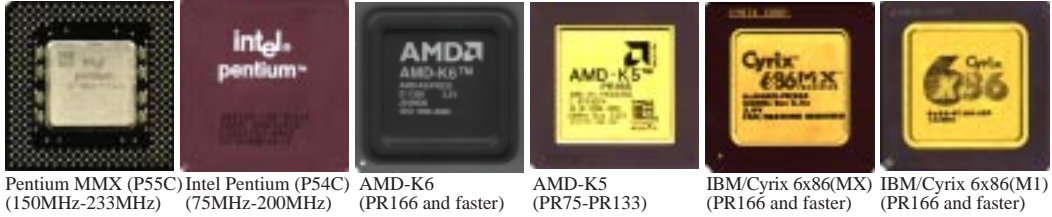

WARNING! Because CPU designs change rapidly, the table below is only intended as a simple guideline and thus may not be true for your CPU. Always refer to the CPU documentation for your CPU's voltage and then set the appropriate VID jumpers according to the illustration below.

Manufacturer	CPU Type	Single Plane	Dual Plane	VID0	VID1	VID2
Intel	P54C/P54CS	3.5V(VRE)	----	[1-2]	[1-2]	[2-3]
AMD	K5	3.5V(VRE)	----	[1-2]	[1-2]	[2-3]
IBM/Cyrix	6x86	3.5V(VRE)	----	[1-2]	[1-2]	[2-3]
Intel	P54C/P54CS	3.4V(STD)	----	[2-3]	[2-3]	[2-3]
AMD	K5	3.4V(STD)	----	[2-3]	[2-3]	[2-3]
Intel	P55C-MMX	----	2.8V(Dual)	[2-3]	[2-3]	[2-3]
AMD (.35micron)	K6-PR233	----	3.2V(Dual)	[2-3]	[2-3]	[1-2]
AMD (.35micron)	K6-166,200	----	2.9V(Dual)	[1-2]	[2-3]	[2-3]
IBM/Cyrix	6x86MX	----	2.9V(Dual)	[1-2]	[2-3]	[2-3]
AMD (.25micron)	K6-233,266,300	----	2.1V(Dual)	[1-2]	[2-3]	[2-3]

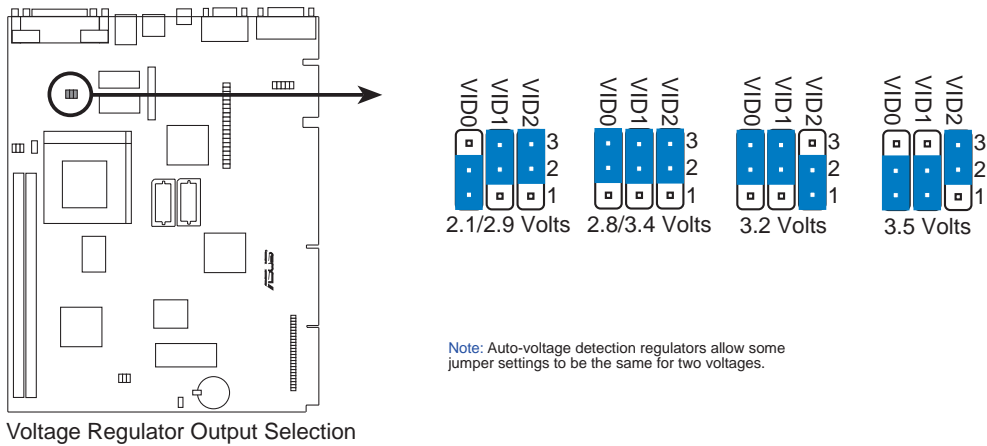

III. INSTALLATION
(Jumpers)

III. INSTALLATION

2. System Memory (DIMM)

Only Dual Inline Memory Modules (DIMM's) can be used with this motherboard. Two sockets are available for **3.3Volt** (power level) Unbuffered Synchronous DRAMs (SDRAM) or EDO DRAM of either 8, 16, 32, 64, or 128MB to form a memory size between 8MB to 512MB. One side (with memory chips) of the DIMM module takes up one Row on the motherboard.

To utilize the chipset's Error Checking and Correction (ECC) feature, you must use a DIMM module with 9 chips per side (standard 8 chips/side + 1 parity chip) and make the proper settings in the BIOS Chipset Features Setup.

IMPORTANT: Memory speed setup is required through "Auto Configuration" in BIOS Chipset Features Setup.

Install memory in any combination as follows:

DIMM Location	168-pin DIMM Memory Modules		Total Memory
Socket 0 (Rows 0&1)	SDRAM/EDO 8, 16, 32, 64, 128MB	x1	
Socket 1 (Rows 2&3)	SDRAM/EDO 8, 16, 32, 64, 128MB	x1	
	Total System Memory (Max 256MB)	=	

III. INSTALLATION
(System Memory)

ASUS DIMM Module Examples:



Parity EDO DIMM (9 chips)

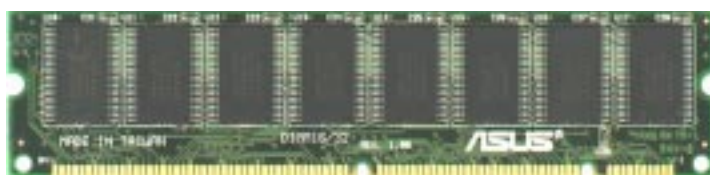

Non-Parity SDRAM DIMM (8 chips)

General DIMM Notes: (not true for all memory modules)

- Four possible memory chips are supported: EDO or SDRAM with and without parity.
- SDRAM chips are generally thinner with higher pin density than EDO chips.
- BIOS shows EDO or SDRAM memory on bootup screen.
- 8 chip/side modules do not support parity, only 9 chip/side modules support parity.
- Single sided modules are usually 16 or 64 MB, double sided are usually 8, 32, or 128MB.

III. INSTALLATION

DIMM Memory Installation Procedures:

Insert the module(s) as shown. Because the number of pins are different on either side of the breaks, the module will only fit in the orientation as shown. DRAM SIMM modules have the same pin contact on both sides. SDRAM DIMM modules have different pin contact on each side and therefore have a higher pin density.

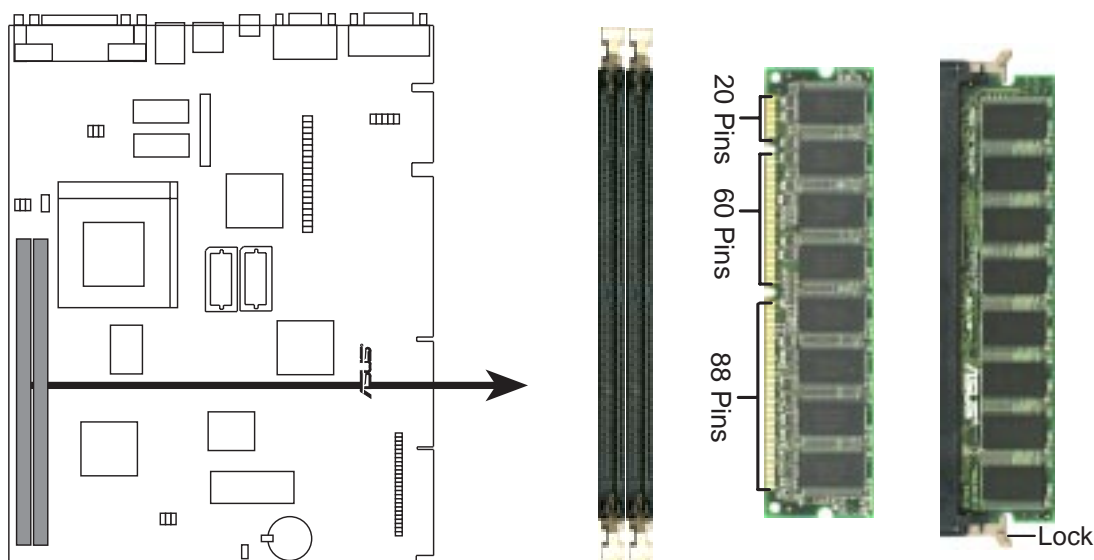

III. INSTALLATION
(System Memory)

168 Pin DIMM Memory Sockets

The Dual Inline Memory Module (DIMM) memory modules must be 3.3Volt Unbuffered Synchronous DRAM (SDRAM) or Extended Data Output (EDO) . You can identify the type of DIMM module by the illustration below:

168-Pin DIMM Notch Key Definitions (3.3V)

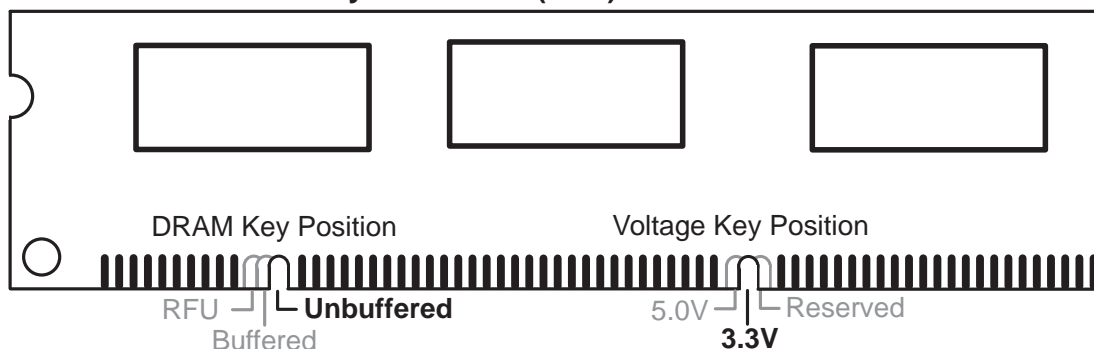

The notch on the DIMM module will shift between left, center, or right to identify the type and also to prevent the wrong type to be inserted into the DIMM slot on the motherboard. You must ask your retailer for the specifications before purchasing. Four clock signals are supported on this motherboard.

III. INSTALLATION

3. Central Processing Unit (CPU)

The motherboard provides a 321-pin ZIF Socket 7 that is backwards compatible with ZIF Socket 5 processors. The CPU that came with the motherboard should have a fan attached to it to prevent overheating. If this is not the case then purchase a fan before you turn on your system.

WARNING! Without a fan circulating air on the CPU, the CPU can overheat and cause damage to both the CPU and the motherboard.

To install a CPU, first turn off your system and remove its cover. Locate the ZIF socket and open it by first pulling the lever sideways away from the socket then upwards to a 90-degree right angle. Insert the CPU with the correct orientation as shown. Use the notched corner of the CPU with the white dot as your guide. The white dot should point towards the end of the lever. Notice that there is a blank area where one hole is missing from that corner of the square array of pin holes and a “1” printed on the motherboard next to that corner. Because the CPU has a corner pin for three of the four corners, the CPU will only fit in the one orientation as shown. The picture is for reference only; you should have a CPU fan that will cover the face of the CPU. With the added weight of the CPU fan, no force is required to insert the CPU. Once completely inserted, hold down on the fan and close the socket’s lever.

IMPORTANT: You must set jumpers for “CPU to BUS Frequency Ratio” and jumpers for “BUS Frequency Selection” depending on the CPU that you install.

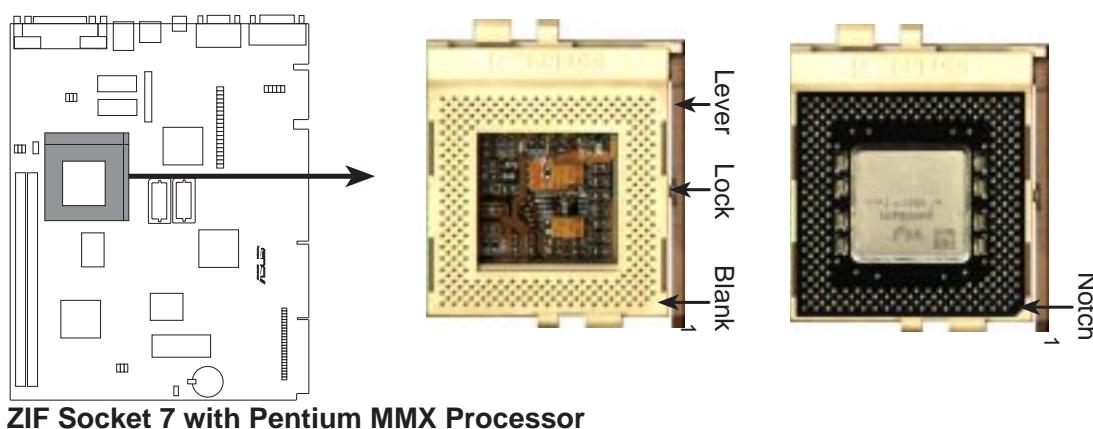

III. INSTALLATION

4. Expansion Cards

WARNING! Make sure that you unplug your power supply when adding or removing expansion cards or other system components. Failure to do so may cause severe damage to both your motherboard and expansion cards.

First read your expansion card documentation on any hardware and software settings that may be required to setup your specific card.

Expansion Card Installation Procedure:

1. Read the documentation for your expansion card.
2. Set any necessary jumpers on your expansion card.
3. Remove your computer system's cover.
4. Remove the bracket on the slot you intend to use. Keep the bracket for possible future use.
5. Carefully align the card's connectors and press firmly.
6. Secure the card on the slot with the screw you removed in step 4.
7. Replace the computer system's cover.
8. Setup the BIOS if necessary
(such as "IRQ xx Used By ISA: Yes" in PNP AND PCI SETUP)
9. Install the necessary software drivers for your expansion card.

Assigning IRQs for Expansion Cards

Some expansion cards need to use an IRQ to operate. Generally an IRQ must be exclusively assigned to one use. In a standard design there are 16 IRQs available but most of them are already in use by parts of the system which leaves 6 free for expansion cards.

Both ISA and PCI expansion cards may need to use IRQs. System IRQs are available to cards installed in the ISA expansion bus first, and any remaining IRQs are then used by PCI cards. Currently, there are two types of ISA cards.

III. INSTALLATION

The original ISA expansion card design, now referred to as “Legacy” ISA cards, requires that you configure the card’s jumpers manually and then install it in any available slot on the ISA bus. You may use Microsoft’s Diagnostic (MSD.EXE) utility included in the Windows directory to see a map of your used and free IRQs. For Windows 95 users, the “Control Panel” icon in “My Computer,” contains a “System” icon which gives you a “Device Manager” tab. Double clicking on a specific device give you “Resources” tab which shows the Interrupt number and address. Make sure that no two devices use the same IRQs or your computer will experience problems when those two devices are in use at the same time.

To simplify this process this motherboard has complied with the Plug and Play (PNP) specification which was developed to allow automatic system configuration whenever a PNP-compliant card is added to the system. For PNP cards, IRQs are assigned automatically from those available.

If the system has both Legacy and PNP ISA cards installed, IRQs are assigned to PNP cards from those not used by Legacy cards. The PCI and PNP configuration of the BIOS setup utility can be used to indicate which IRQs are being used by Legacy cards. For older Legacy cards that does not work with the BIOS, you can contact your vendor for an ISA Configuration Utility.

An IRQ number is automatically assigned to PCI expansion cards after those used by Legacy and PNP ISA cards. In the PCI bus design, the BIOS automatically assigns an IRQ to a PCI slot that has a card in it that requires an IRQ. To install a PCI card, you need to set something called the INT (interrupt) assignment. Since all the PCI slots on this motherboard use an INTA #, be sure that the jumpers on your PCI cards are set to INT A.

Assigning DMA Channels for ISA Cards

Some ISA cards, both legacy and PnP, may also need to use a DMA (Direct Memory Access) channel. DMA assignments for this motherboard are handled the same way as the IRQ assignment process described earlier. You can select a DMA channel in the PCI and PnP configuration section of the BIOS Setup utility.

IMPORTANT: To avoid conflicts, reserve the necessary IRQs and DMAs for legacy ISA cards (under PNP AND PCI SETUP of the BIOS SOFTWARE, choose *Yes* in *IRQ xx Used By ISA* and *DMA x Used By ISA* for those IRQs and DMAs you want to reserve).

ISA Cards and Hardware Monitor

The onboard hardware monitor uses the address 290H-297H so legacy ISA cards must not use this address or else conflicts will occur.

III. INSTALLATION

5. External Connectors

WARNING! Some pins are used for connectors or power sources. These are clearly separated from jumpers in “Map of the Motherboard.” Placing jumper caps over these will cause damage to your motherboard.

IMPORTANT: Ribbon cables should always be connected with the red stripe on the Pin 1 side of the connector. The four corners of the connectors are labeled on the motherboard. Pin 1 is the side closest to the power connector on hard drives and floppy drives. IDE ribbon cable must be less than 18in. (46cm), with the second drive connector no more than 6in. (15cm) from the first connector.

1. PS/2 Keyboard Connector (6-pin Female)

This connector is for a standard keyboard using an PS/2 plug (mini DIN). **This connector will not allow standard AT size (large DIN) keyboard plugs. You may use a DIN to mini DIN adapter on standard AT keyboards.**

2. PS/2 Mouse Connector (6-pin Female)

The system will direct IRQ12 to the PS/2 mouse if one is detected. If not detected, expansion cards can use IRQ12. See “PS/2 Mouse Control” in BIOS Features Setup of the BIOS SOFTWARE.

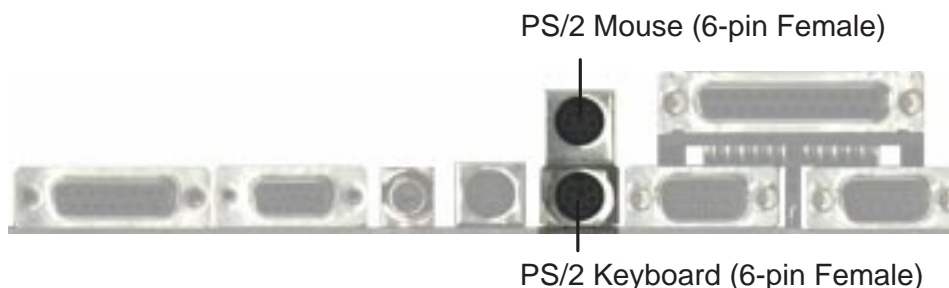

3. Joystick/MIDI Connector (15-pin Female)

This connector is for a standard joystick or MIDI device.



III. INSTALLATION

4. Parallel Printer Connector (25-pin Female)

You can enable the parallel port and choose the IRQ through “Onboard Parallel Port” in Chipset Features Setup of the BIOS SOFTWARE. **NOTE:** Serial printers must be connected to the serial port.

Parallel (Printer) Port (25-pin Female)



5. Serial Port COM1 and COM2 Connectors (Two 9-pin Male)

The two serial ports can be used for pointing devices or other serial devices. See “Onboard Serial Port” in Chipset Features Setup of the BIOS SOFTWARE.



6. VGA Connector (15-pin Female)

This connector is for displaying on a standard VGA-compatible device.

VGA Monitor (15-pin Female)



7. TV Out Connectors (RCA and 4-pin Female S-Video) (optional)

These connectors are for displaying on a television using the RCA connector or the S-Video connector.

TV Out Connectors

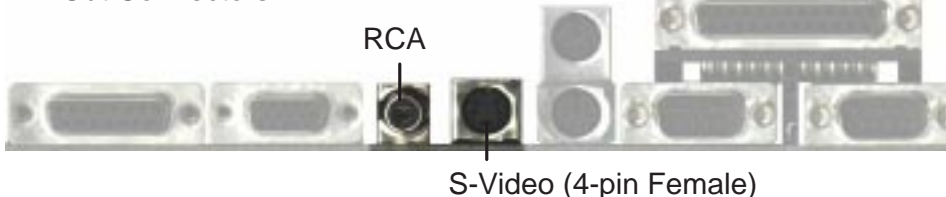

III. INSTALLATION

8. Universal Serial BUS Ports 1 & 2 (Two 4-pin Female Sockets)

Two USB ports are available for connecting USB devices.

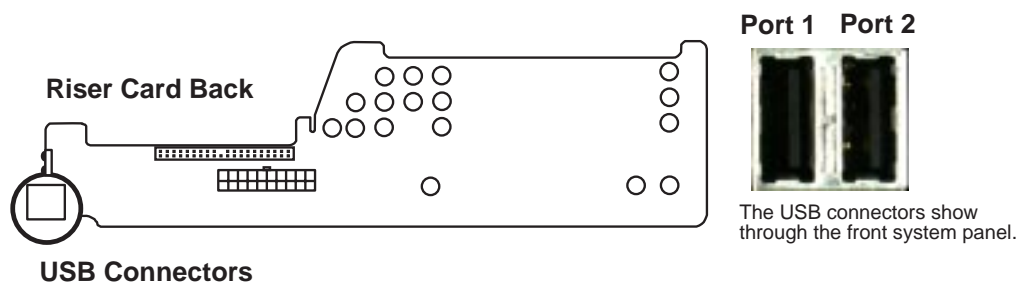

9. IrDA / Fast IR-Compliant Infrared Module

This is an onboard infrared module for wireless transmitting and receiving data through the front panel infrared lens.

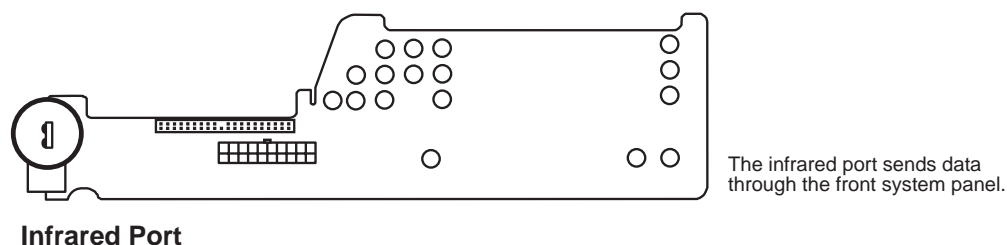

10. NLX Power Supply Connector (20-pin NLXPWR)

This connector connects to an NLX power supply. The plug from the power supply will only insert in one orientation because of the different hole sizes. Find the proper orientation and push down firmly making sure that the pins are aligned.

IMPORTANT: Be sure that the NLX power supply can deliver at least 720mAmp on the 5volt standby lead (5VSB). You may experience difficulty in powering on your system without this specification.

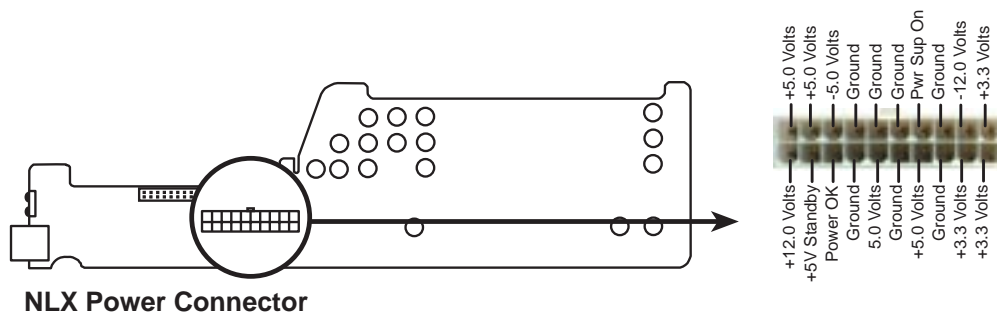

III. INSTALLATION

11. Primary IDE Connector (40-pin IDE)

This connector supports the provided IDE hard disk drive ribbon cable. After connecting one end to the riser card, connect the other end to a hard disk drive. The primary IDE channel supports both a master and a slave IDE device but the system housing size only permits a standard IDE hard drive to be installed.

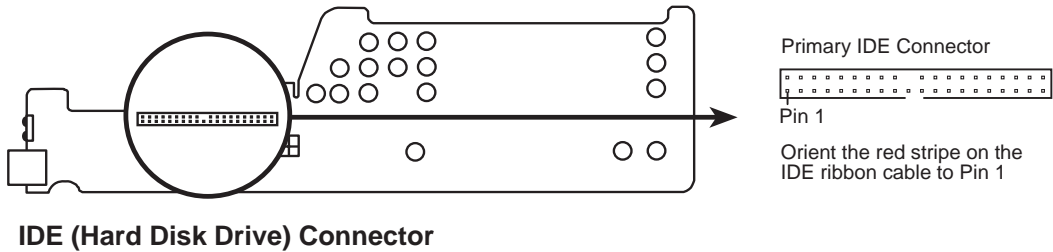

12. 3.5inch Floppy Disk Drive Connector (34-pin FLOPPY)

This connector supports the provided floppy drive ribbon cable. After connecting the single end to the riser card, connect the other end to a 3.5inch floppy disk drive.

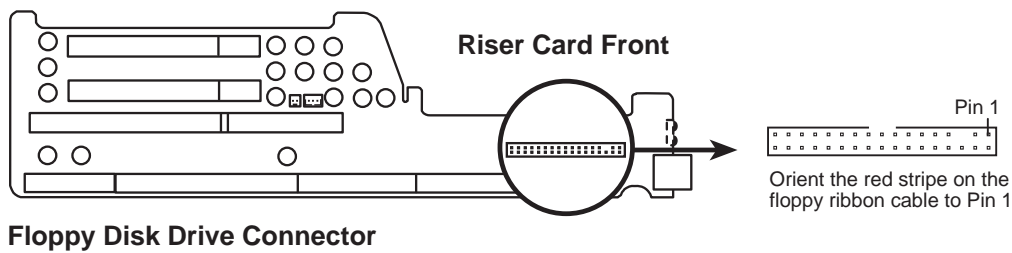

13. LAN Activity Connectors (2-pin LAN_LED & 3-pin WOL_CON)

These connectors support Local Area Network (LAN) cards such as the ASUS PCI-L101 with output signals for data transfer activity. The LAN_LED connector allows the front panel LED to blink during transfer activity between the network and the computer. The WOL_CON connector allows the system to power up when there is a wakeup package (signal) received from the network.

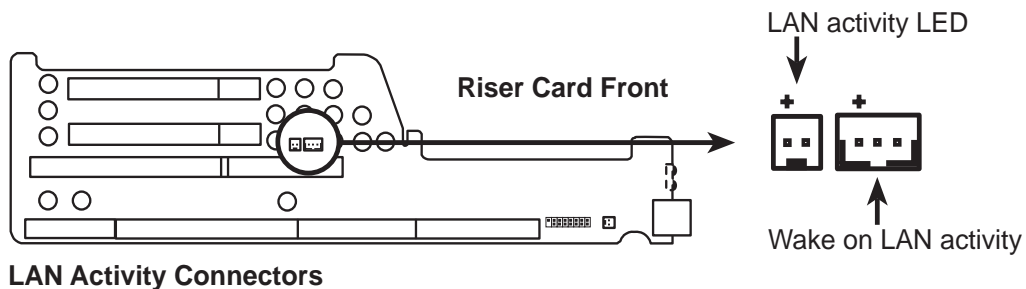

III. INSTALLATION

14. Riser Front Panel Connector (16-1 pin)

This connector is used to connect the front panel display LED's and buttons to the motherboard through a ribbon cable.

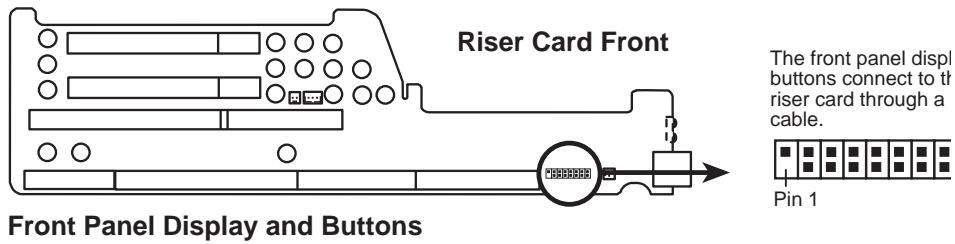

Front Panel Display and Buttons

15. Riser Front Panel Microphone Connector (2 pin)

This connector is used to connect the front panel microphone jack to the motherboard through a ribbon cable.

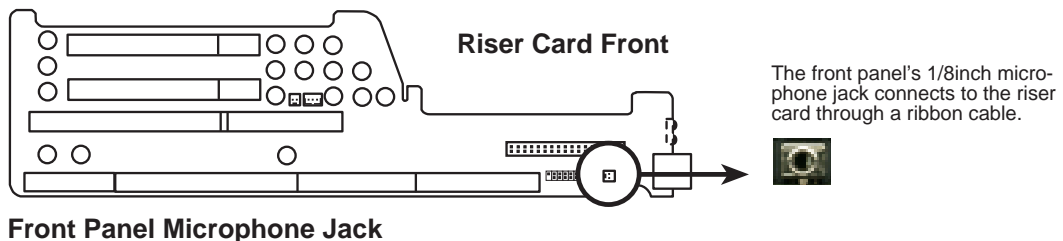

Front Panel Microphone Jack

III. INSTALLATION

Front Panel Descriptions

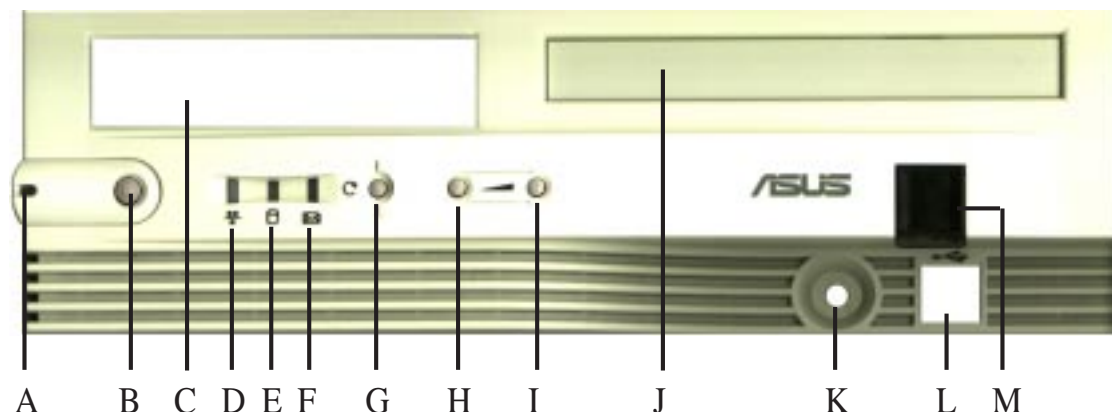

A. System Power LED

Lights when the system is powered on and blinks when it is in sleep mode.

B. NLX Power Button/ Soft Power Button

Switches between ON, OFF, and SLEEP mode. The functions are controlled and configurable through the “Power Up Control” in the POWER MANAGEMENT SETUP of the BIOS SOFTWARE.

C. Floppy Drive Bay

Accepts a standard 3.5inch floppy drive, LS-120, or other compatible devices.

D. Network Activity LED

Blinks when data is transferred to or from a network card. (The network card requires an external LED wire connected to the Riser card’s LAN_LED.)

E. IDE Activity LED

Blinks when data is transferred via the IDE channels, includes the CD-ROM.

F. Message LED

The LED will remain lit when there is no modem activity and blink when there is data being transferred or waiting in the inbox.

G. Reset Button

Switch used for rebooting the computer without having to use the power switch

H. Volume Down Button

Decreases the onboard audio amplifier’s volume.

I. Volume Up Button

Increases the onboard audio amplifier’s volume.

J. CD-ROM Drive Bay

Accepts only a notebook-size CD-ROM.

K. Microphone Jack

Accepts a 1/8inch connector from a microphone or other audio source.

L. USB Port1 and Port 2

Accepts 15 USB devices on each port.

M. Infrared Window

Allows transmission and reception of infrared signals by the onboard module.

III. INSTALLATION

16. ATI Multimedia Connector (40-3 pin AMC)

This connector is used for ATI video accessories such as video capture cards or television tuners.

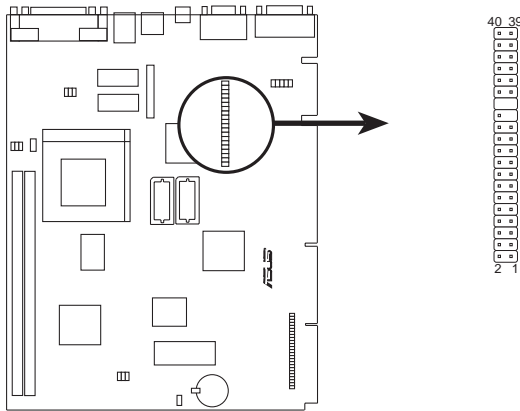

ATI Multimedia Connector

17. Audio Connectors (Three 1/8inch. female)

These connectors are provided for audio input and output signals.

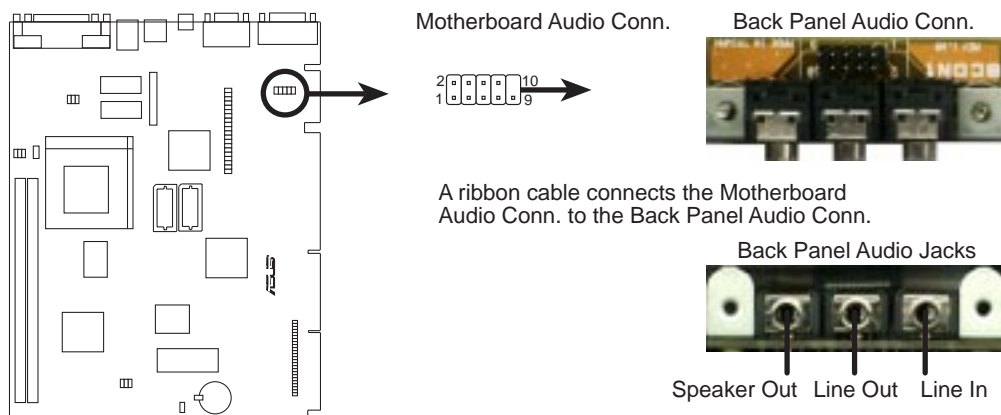

Audio Jack Connector

18. CPU Fan Connector (3-pin)

This connector support a cooling fan of 500mAMP (6WATT) or less.

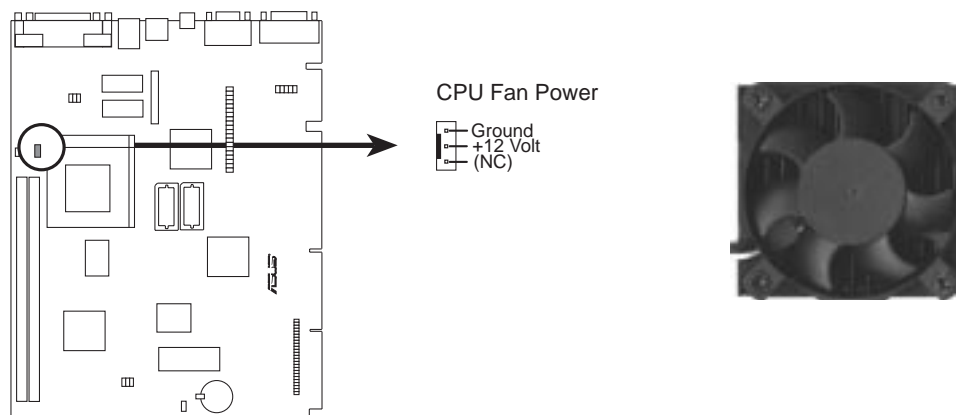

12Volt Cooling Fan Power

III. INSTALLATION

19. VGA Memory Sockets (40 pins)

There are 1MB memory standard for the onboard VGA. Add two DRAM chips to upgrade the onboard VGA memory to 2MB.

20. CD-ROM Connector (50-1 pin CDROM)

This is a proprietary CD-ROM connector which requires a converter in order to attach to a slim CD-ROM. Only a slim CD-ROM will fit in the NLX system housing.

III. INSTALLATION

Power Connection Procedures

1. After all jumpers settings and connections are made, close and secure the system housing cover.
 2. Make sure that all your computer's peripherals are switched off.
 3. Connect the power supply cords into your computer's peripherals and system power supply.
 4. Connect the power cords into a power source that is equipped with a surge protector such as a UPS or protected power strip.
 5. Turn on your computer by pressing the power switch on the front of the case.
 6. The power LED on the front panel of the system case will light. The system will then run power-on tests. While the tests are running, additional messages will appear on the screen. If you do not see anything within 30 seconds from the time you turn on the power, the system may have failed a power-on test. Recheck your jumper settings and connections or call your retailer for assistance.
 7. During power-on, press <Delete> to enter the BIOS setup. Follow the instructions on the next section, "BIOS SOFTWARE."
- * **Powering Off Your Computer:** You must first exit or shut down your operating system before pressing the power switch. For Windows 95/NT users, click the **Start** button, **Shut Down...**, then **Yes** when asked **Shut down the computer?** The operating system will close Windows 95/NT and power off your computer.

NOTE: The message, **It's now safe to turn off your computer**, will not be shown in Windows 95/NT when using Shut Down with NLX power supplies.

IV. BIOS SOFTWARE

Support Software

NOTE: This motherboard has onboard VGA and Audio which requires a 2Mbit flash ROM. This flash ROM requires PFLASH2.EXE as opposed to PFLASH.EXE as used by other ASUS motherboards with 1Mbit flash ROM.

PFLASH2.EXE - This is the Flash Memory Writer utility that updates the BIOS by uploading a new BIOS file to the 2Mbit programmable flash ROM chip on the motherboard. To determine the BIOS version, check the last four numbers of the code displayed on the upper left-hand corner of your screen during bootup. Larger numbers represent a newer BIOS file. This file works in DOS or Windows mode.

NOTE: A binary BIOS file is no longer included with the support software. Save the motherboard's BIOS file to a floppy disk as soon as your system is operational. See "Flash Memory Writer Utility" in this section to "Save Current BIOS to File."

NOTE: The following screen contents in this user's manual are provided as examples only and may not reflect the screen contents displayed on your system.

Flash Memory Writer Utility

```
ASUS!Tek PnP BIOS
FLASH MEMORY WRITER V1.5
Copyright (C) 1995, ASUS!Tek COMPUTER INC.

Flash Type -- INTEL 28F001BK1
Current BIOS Revision: #40100-0204-0
Choose one of the following:
1. Save Current BIOS To File
2. Update BIOS Main Block From File
3. Advanced Feature

Enter choice: 111

Press ESC To Exit
```

IMPORTANT! If "unknown" is displayed after **Flash Type --** , the memory chip is either not programmable or is not supported with the PnP BIOS and therefore cannot be programmed by the Flash Memory Writer utility.

Main Menu

1. Save Current BIOS To File

This option allows you to save a copy of the original motherboard BIOS in case you need to reinstall it. It is recommended that you save PFLASH2 and the BIOS file to a bootable floppy diskette.

2. Update BIOS Main Block From File

This option updates the BIOS from a file on the disk. The file can be either a new file or a backup file created by the "Save Current BIOS To File" option. If the boot block in the file is different from the current boot block, this option will not update the main block. Instead, it will display the following messages.

IV. BIOS SOFTWARE

```
Update BIOS Main Block From File

Flash Type -- INTEL 28F001BK1
Current BIOS Revision: #40100-0204-0
Please Enter File Name for NEW BIOS: a:\0205.003
Are you Sure (Y/N) ? [Y]

Boot Block of New BIOS is different from old one !!!
Please Use 'Advanced Feature' to flash whole bios !!!

Press ESC To Return to Main Menu
```

3. Advanced Features

This option displays the Advanced Features screen for clearing the PnP configuration record and updating the motherboard BIOS.

```
Advanced Feature

Flash Type -- INTEL 28F001BK1
Current BIOS Revision: #40100-0204-0
Choose one of the following:
1. Clear PNP ESCD Parameter Block
2. Update BIOS Including Boot Block and ESCD

Enter choice: [2]

Press ESC To Return to Main Menu
```

Advanced Features Menu

1. Clear PNP ESCD Parameter Block

This option erases the Plug-and-Play (PnP) configuration record.

2. Update BIOS Including Boot Block and ESCD

This option updates the boot block, the baseboard BIOS, and the PnP extended system configuration data (ESCD) parameter block from a new BIOS file.

```
Update BIOS Including Boot Block and ESCD

Flash Type -- INTEL 28F001BK1
Current BIOS Revision: #40100-0204-0
Please Enter File Name for NEW BIOS: 0205.003
Are you Sure (Y/N) ? [Y]

Block Erasing -- Done
Programming -- 1FFF
Block Erasing -- Done
Programming -- 1FFF

Flashed Successfully
Press ESC To Continue
```

IV. BIOS SOFTWARE

Managing and Updating Your Motherboard's BIOS

Upon First Use of the Computer System

1. Create a bootable system floppy diskette by typing [FORMAT A:/S] from the DOS prompt without creating "AUTOEXEC.BAT" and "CONFIG.SYS" files.
2. Copy PFLASH2.EXE to your new diskette.
3. Run PFLASH2.EXE from your new diskette and select option 1 "Save Current BIOS to File." Enter the "Current BIOS Revision:" for the file name.

Updating BIOS Procedures (only when necessary)

1. Download an updated ASUS BIOS file from the Internet (WWW or FTP) or a BBS (Bulletin Board Service) (see ASUS CONTACT INFORMATION on page 3 for details) and save to the disk you created earlier.
2. Boot from the disk you created earlier.
3. At the "A:\>" prompt, type PFLASH2 and then press <Enter>.
4. Enter 2 "Update BIOS Main Block From File" from the Main Menu or option 2 "Update BIOS Including Boot Block and ESCD" from the Advanced Features Menu if prompted by option 2 of the Main Menu.
5. The program displays a second screen prompting you for the name of the BIOS file. Type in the complete file name and extension of the new BIOS, and then press <Enter>. The utility then updates the BIOS file from disk.

WARNING! If you encounter problems while updating the new BIOS, DO NOT turn off your system since this might prevent your system from booting up. Just repeat the process, and if the problem still persists, update the original BIOS file you saved to disk above. If the Flash Memory Writer utility was not able to successfully update a complete BIOS file, your system may not be able to boot up. If this happens, your system will need service.

6. After successfully updating the new BIOS file, exit the Flash Memory Writer utility and then reboot.
7. Hold down <Delete> to enter BIOS setup. You must select "Setup Default" to effect the new BIOS, after which you may set the other items from the Main Menu.

IV. BIOS SOFTWARE

6. BIOS Setup

The motherboard supports two programmable Flash ROM chips: 5 volts and 12 volts. Either of these memory chips can be updated when BIOS upgrades are released. Use the Flash Memory Writer utility to download the new BIOS file into the ROM chip as described in detail in this section.

All computer motherboards provide a Setup utility program for specifying the system configuration and settings. If your motherboard came in a computer system, the proper configuration entries may have already been made. If so, run the Setup utility, as described later, and take note of the configuration settings for future reference, in particular, the hard disk specifications.

If you are installing the motherboard, reconfiguring your system or you receive a Run Setup message, you will need to enter new setup information. This section describes how to configure your system using this utility.

The BIOS ROM of the system stores the Setup utility. When you turn on the computer, the system provides you with the opportunity to run this program. This appears during the Power-On Self Test (POST). Press <Delete> to call up the Setup utility. If you are a little bit late pressing <Delete>, POST will continue with its test routines, thus preventing you from calling up Setup. If you still need to call Setup, reset the system by pressing <Ctrl> + <Alt> + <Delete>, or by pressing the Reset button on the system case. You can also restart by turning the system off and then back on again. Do this only, however, if the first two methods fail.

When you run Setup, the CMOS SETUP UTILITY main program screen will appear with the following options:



IV. BIOS SOFTWARE

Load Defaults

Load BIOS Defaults loads the minimized settings for troubleshooting. **Load Setup Defaults**, on the other hand, is for loading optimized defaults for regular use. Choosing defaults at this level will modify all applicable settings.

A section at the bottom of the preceding screen displays the control keys for this screen. Take note of these keys and their respective uses. Another section just below the control keys section displays information on the currently highlighted item in the list.

Standard CMOS Setup

Standard CMOS Setup allows you to record some basic system hardware configuration and set the system clock and error handling. If the motherboard is already installed in a working system, you will not need to select this option anymore. However, if the configuration stored in the CMOS memory on the board gets lost or damaged, or if you change your system hardware configuration, you will need to respecify the configuration values. The configuration values usually get lost or corrupted when the power of the onboard CMOS battery weakens.



User-configurable fields appear in a different color. If you need information on the selected field, press <F1>. The help menu will then appear to provide you with the information you need. The memory display at the lower right-hand side of the screen is read-only and automatically adjusts accordingly.

IV. BIOS SOFTWARE

Details of Standard CMOS Setup:

Date

To set the date, highlight the “Date” field and then press either <Page Up>, <Page Down>, plus or minus signs (on the numeric keypad) to set the current date. Follow the month, day and year format. Valid values are **Month: (1 to 12)**, **Day: (1 to 31)**, **Year: (up to 2079)**.

Time

To set the time, highlight the “Time” field and then press either <Page Up>, <Page Down>, plus or minus signs (on the numeric keypad) to set the current time. Follow the hour, minute and second format. Valid values are **Hour: (00 to 23)**, **Minute: (00 to 59)**, **Second: (00 to 59)**.

NOTE: You can bypass the date and time prompts by creating an AUTOEXEC.BAT file. For information on how to create this file, please refer to the MS-DOS manual.

Hard Disk Drives

This field records the specifications for all non-SCSI hard disk drives installed in your system. The onboard PCI IDE connectors provide Primary and Secondary channels for connecting up to four IDE hard disks or other IDE devices. Each channel can support up to two hard disks; the first of which is the “master” and the second is the “slave”.

Specifications for SCSI hard disks need not to be entered here because they operate using device drivers and are not supported by any BIOS. If you install the optional PCI-SC200 SCSI controller card into the motherboard (see section VI for instructions). If you install other vendor’s SCSI controller card, refer to the documentation that came with the card on how to install the required SCSI drivers.

For IDE hard disk drive setup, you can:

- Use the *Auto* setting for detection during bootup.
- Use the IDE HDD AUTO DETECTION in the main menu to automatically enter the drive specifications.
- Enter the specifications yourself manually by using the “User” option.

The entries for specifying the hard disk type include **CYLS** (number of cylinders), **HEAD** (number of read/write heads), **PRECOMP** (write precompensation), **LANDZ** (landing zone), **SECTOR** (number of sectors) and **MODE**. The **SIZE** field automatically adjusts according to the configuration you specify. The documentation that came with your hard disk should provide you with the information regarding the drive specifications.

IV. BIOS SOFTWARE

The **MODE** entry is for IDE hard disks only, and can be ignored for MFM and ESDI drives. This entry provides three options: *Normal*, *Large*, *LBA*, or *Auto* (see below). Set **MODE** to the *Normal* for IDE hard disk drives smaller than 528MB; set it to *LBA* for drives over 528MB that support Logical Block Addressing (LBA) to allow larger IDE hard disks; set it to *Large* for drives over 528MB that do not support LBA. *Large* type of drive can only be used with MS-DOS and is very uncommon. Most IDE drives over 528MB support the *LBA* mode.

Autodetection of Hard Disks on Bootup

For each field, Primary Master, Primary Slave, Secondary Master, and Secondary Slave, you can select *Auto* under the TYPE and MODE fields. This will enable auto detection of your IDE disk drives during bootup. This will allow you to change your hard disks (with the power off) and then power on without having to reconfigure your hard disk type. If you use older hard disks that do not support this feature, then you must configure the hard disk in the standard method as described earlier using the “User” option.

NOTE: After the IDE hard disk drive information has been entered into BIOS, new IDE hard disk drives must be partitioned (such as with FDISK) and then formatted before data can be read from and write on. Primary IDE hard disk drives must have its partition set to *active* (also possible with FDISK).

NOTE: SETUP Defaults are noted in parenthesis next to each function heading.

Drive A / Drive B (None)

These fields record the types of floppy disk drives installed in your system. The available options for drives A and B are *360KB, 5.25 in.; 1.2MB, 5.25 in.; 720KB, 3.5 in.; 1.44MB, 3.5 in.; 2.88MB, 3.5 in.; None*.

To enter the configuration value for a particular drive, highlight its corresponding field and then select the drive type using the left or right arrow keys.

Floppy 3 Mode Support (Disabled)

This is the Japanese standard floppy drive. The standard stores 1.2MB in a 3.5-inch disk drive. This is normally disabled but you may choose from either *Drive A*, *Drive B*, *Both*, or *Disabled*.

Video (EGA/VGA)

Set this field to the type of video display card installed in your system. The options are *EGA/VGA*, *CGA 40*, *CGA 80*, and *Mono (for Hercules or MDA)*. If you are using a VGA or any higher resolution card, choose *EGA/VGA*.

Halt On (All Errors)

This field determines which types of errors will cause the system to halt. Choose from either *All Errors*; *No Errors*; *All, But Keyboard*; *All, But Diskette*; or *All, But Disk/Key*.

IV. BIOS SOFTWARE

BIOS Features Setup

BIOS Features Setup consists of configuration entries that allow you to improve your system performance, or let you set up some system features according to your preference. Some entries are required by the motherboard's design to remain in their default settings.



NOTE: SETUP Defaults are noted in parenthesis next to each function heading.

Details of BIOS Features Setup

Virus Warning (Disabled)

This field protects the boot sector and partition table of your hard disk against accidental modifications. Any attempt to write to them will cause the system to halt and display a warning message. If this occurs, you can either allow the operation to continue or use a bootable virus-free floppy disk to reboot and investigate your system. This setting is recommended because of conflicts with new operating systems or some programs. Installation of these programs requires that you disable *Virus Warning* to prevent write errors.

CPU Internal Cache (Enabled)

Choose *Disable* to turn off the CPU's built-in level 1 cache.

External Cache (Enabled)

Choose *Disable* to turn off the CPU's external level 2 cache.

Quick Power On Self Test (Enabled)

This field speeds up the Power-On Self Test (POST) routine by skipping retesting a second, third, and fourth time. Setup default setting for this field is *Enabled*. A complete test of the system is done on each test.

HDD Sequence SCSI/IDE First (IDE)

When using both SCSI and IDE hard disk drives, IDE is always the boot disk using drive letter C (default setting of *IDE*). This new feature allows a SCSI hard disk drive to be the boot disk when set to *SCSI*. This allows multiple operating systems to be used on both IDE and SCSI drives or the primary operating system to boot using a SCSI hard disk drive.

IV. BIOS SOFTWARE

Boot Sequence (C,A)

This field determines where the system looks first for an operating system. Options are *C,A*; *A,CDROM,C*; *CDROM,C,A*; *D,A*; *E,A*; *F,A*; *C only*; *LS/ZIP, C*; and *A,C*. The default is to check first the hard disk and then the floppy disk drive, that is, *C, A*.

Boot Up Floppy Seek (Disabled)

When enabled, the BIOS will seek drive A one time.

Floppy Disk Access Control (R/W)

This allows protection of files from the computer system to be copied to floppy disk drives by allowing the setting of *Read Only* to only allow reads from the floppy disk drive but not writes. The setup default *R/W* allows both reads and writes.

IDE HDD Block Mode Sectors (HDD MAX)

This field enhances hard disk performance by making multi-sector transfers instead of one sector per transfer. Most IDE drives, except older versions, can utilize this feature. Selections are *HDD MAX*, *Disabled*, *2*, *4*, *8*, *16*, and *32*.

Security Option (System)

This field determines when the system prompts for the password. The default setting is *System*, where the system prompts for the User Password every time you boot up. The other option is *Setup*, where the system always boots up, and prompts for the Supervisor Password only when the Setup utility is called up. You can specify a password by using the *Supervisor Password* or *User Password* option from the main screen as explained later in this section.

PS/2 Mouse Function Control (Auto)

Auto allows the BIOS to detect the PS/2 mouse on bootup. If detected, IRQ12 will be used for the PS/2 Mouse. If not detected, IRQ12 will be reserved for expansion cards. *Enabled* will always reserve IRQ12 for devices on the PS/2 mouse port.

PCI/VGA Palette Snoop (Disabled)

Some display cards that are nonstandard VGA such as graphics accelerators or MPEG Video Cards may not show colors properly. The setting *Enabled* should correct this problem. Otherwise leave this on the setup default setting of *Disabled*.

OS/2 Onboard Memory > 64M (Disabled)

When using OS/2 operating systems with installed DRAM of greater than 64MB, you need to *Enable* this option otherwise leave this on the setup default of *Disabled*.

.....

Video ROM BIOS Shadow (Enabled)

This field allows you to change the video BIOS location from ROM to RAM. Relocating to RAM enhances system performance, as information access is faster than the ROM.

C8000-CBFFF to DC000-DFFFF (Disabled)

These fields are used for shadowing other expansion card ROMs. If you install other expansion cards with ROMs on them, you will need to know which addresses the ROMs use to shadow them specifically. Shadowing a ROM reduces the memory available between 640KB and 1024KB by the amount used for this purpose.

IV. BIOS SOFTWARE

Boot Up NumLock Status (On)

This field enables users to activate the Number Lock function upon system boot.

Typematic Rate Setting (Disabled)

When enabled, you can set the two typematic controls listed next. Setup default setting is *Disabled*.

Typematic Rate (Chars/Sec) (6)

This field controls the speed at which the system registers repeated keystrokes. Options range from 6 to 30 characters per second. Setup default setting is **6**; other settings are *8, 10, 12, 15, 20, 24, and 30*.

Typematic Delay (Msec) (250)

This field sets the time interval for displaying the first and second characters. Four delay rate options are available: 250, 500, 750, and 1000.

Chipset Features Setup

This “Chipset Features Setup” option controls the configuration of the board’s chipset. Control keys for this screen are the same as for the previous screen.



IV. BIOS
(Chipset Features)

NOTE: SETUP Defaults are noted in parenthesis next to each function heading.

Details of Chipset Features Setup

Auto Configuration (60ns DRAM)

The default setting of *60ns DRAM* sets the optimal timings for items 2 through 9 for 60ns DRAM modules. If you are using 70ns DRAM modules, you must change this item to *70ns DRAM*. See section III for DRAM installation information.

SDRAM CAS# Latency (Leave on default setting of 3T)

IV. BIOS SOFTWARE

SDRAM CAS# Latency (3T)

If you use ASUS SDRAM DIMM modules, you can set this to 2T for better performance, otherwise leave on default or check with your vendor for DIMM specs.

SDRAM Speculative Read (Disabled)

If *Enabled*, the CPU will issue predict commands to access the DRAM, if a miss occurs, the CPU will cancel this command. Some operating systems under certain situations have a problem utilizing this feature so it is normally *Disabled*.

Passive Release (Enabled)

This is a mechanism that allows concurrency of ISA/EISA cycles and CPU-to-PCI cycles. When this feature is enabled, the TXC will be possible to re-arbitrate PCI bus and allow the CPU to access PCI even when the PCEB has been granted the bus.

Delayed Transaction (Disabled)

If *Enabled*, this frees the PCI Bus during CPU accessing of 8-bit ISA cards which normally consume about 50-60 PCI Clocks without PCI delayed transaction. If PCI Bus Masters cannot use the PCI Bus, leave this on the default setting of *Disabled* for some ISA cards that are not PCI 2.1 compliant.

16-bit I/O Recovery Time (1 BUSCLK)

Timing for 16-bit ISA cards.

8-bit I/O Recovery Time (1 BUSCLK)

Timing for 8-bit ISA cards.

Video BIOS Cacheable (Enabled)

Allows the Video BIOS to be cached to allow faster execution. Leave on default setting of *Enabled* for better performance, otherwise *Disabled*.

Memory Hole at Address (None)

This features reserves either 14MB-16MB or 15MB-16MB memory address space to ISA expansion cards that specifically require this setting. Memory from 14MB and up or 15MB and up will be unavailable to the system because expansion cards can only access memory up to 16MB.

.....

Onboard FDC Controller (Enabled)

When enabled, this field allows you to connect your floppy disk drives to the onboard floppy drive connector instead of a separate controller card. If you want to use a different controller card to connect the floppy drives, set this field to *Disabled*.

Onboard FDC Swap A & B (No Swap)

This field allows you to reverse the hardware drive letter assignments of your floppy disk drives. Two options are available: *Swap AB* and *No Swap* (default). If you want to switch drive letter assignments, set this field to *Swap AB*, and the swap will be controlled by the onboard chipset.

IV. BIOS SOFTWARE

Onboard Serial Port 1 (3F8H/IRQ4)

Settings are *3F8H/IRQ4*, *2F8H/IRQ3*, *3E8H/IRQ4*, *2E8H/IRQ10*, and *Disabled* for the onboard serial connector.

Onboard Serial Port 2 (2F8H/IRQ3)

Settings are *3F8H/IRQ4*, *2F8H/IRQ3*, *3E8H/IRQ4*, *2E8H/IRQ10*, and *Disabled* for the onboard serial connector.

Onboard Parallel Port (378H/IRQ7)

This field sets the address of the onboard parallel port connector. You can select either *3BCH/IRQ7*, *378H/IRQ7*, *278H/IRQ5*, or *Disabled*. If you install an I/O card with a parallel port, ensure that there is no conflict in the address assignments. The PC can support up to three parallel ports as long as there are no conflicts for each port.

Parallel Port Mode (ECP+EPP)

This field allows you to set the operation mode of the parallel port. The setting *Normal*, allows normal-speed operation but in one direction only; *EPP* allows bidirectional parallel port operation at maximum speed; *ECP* allows the parallel port to operate in bidirectional mode and at a speed faster than the maximum data transfer rate; *ECP+EPP* allows normal speed operation in a two-way mode.

ECP DMA Select (3)

This selection is available only if you select *ECP* or *ECP+EPP* in the **Parallel Port Mode**. Select either DMA Channel *1*, *3*, or *Disabled*.

UART2 Use Infrared (Disabled)

When enabled, this field activates the onboard infrared feature and sets the second serial UART to support the infrared module connector on the motherboard. If your system already has a second serial port connected to the onboard COM2 connector, it will no longer work if you enable the infrared feature. By default, this field is set to *Disabled*, which leaves the second serial port UART to support the COM2 serial port connector.

Onboard PCI IDE Enable (Both)

You can select to enable the *Primary* IDE channel, *Secondary* IDE channel, *Both*, or *Disable* both channels (for systems with only SCSI drives).

IDE Ultra DMA Mode (Auto)

This sets the IDE UltraDMA to be active when using UltraDMA-capable IDE devices. The BIOS will automatically adjust or disable this setting for slower IDE devices so that Auto or high settings will not cause problems for older IDE devices. Choose *Disable* if you do not want this feature for all devices.

IDE 0 Master/Slave PIO/DMA Mode, IDE 1 Master/Slave PIO/DMA Mode (Auto)

Each channel (0 & 1) has both a master and a slave making four IDE devices possible. Because each IDE device may have a different Mode timing (0, 1, 2, 3, 4), it is necessary for these to be independent. PIO and DMA timings can be independently set. The default setting of *Auto* will allow autodetection to ensure optimal performance.

IV. BIOS SOFTWARE

Power Management Setup

This “Power Management Setup” option allows you to reduce power consumption. This feature turns off the video display and shuts down the hard disk after a period of inactivity.

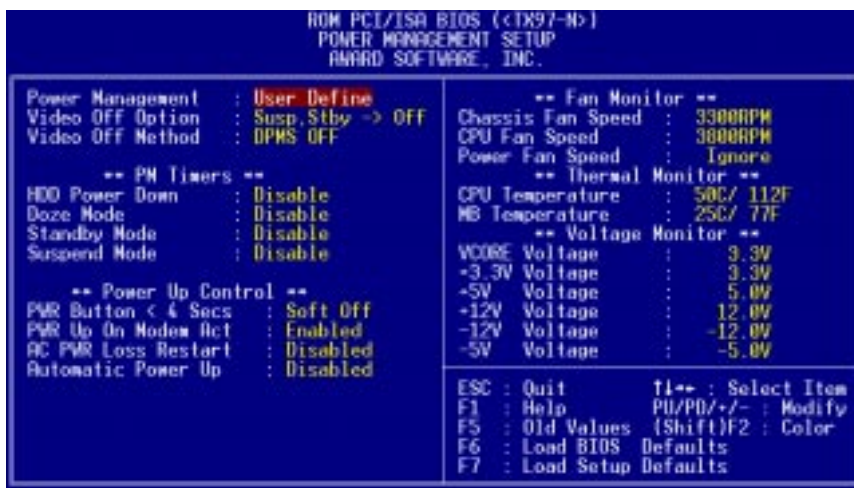

NOTE: SETUP Defaults are noted in parenthesis next to each function heading.

Details of Power Management Setup

Power Management (User Define)

This field acts as the master control for the power management modes. *User Define* allows you to set power saving options according to your preference; *Disable* disables the power saving features; *Min Saving* puts the system into power saving mode after 40 min of system inactivity; *Max Saving* puts the system into power saving mode after 30 sec of system inactivity.

IMPORTANT: Advanced Power Management (APM) should be installed to keep the system time updated when the computer enters suspend mode activated by the BIOS Power Management. For DOS environments, you need to add `DEVICE=C:\DOS\POWER.EXE` in you `CONFIG.SYS`. For Windows 3.x and Windows 95, you need to install Windows with the APM feature. A battery and power cord icon labeled “Power” will appear in the “Control Panel.” Choose “Advanced” in the Power Management Field.

Video Off Option (Susp,Stby -> Off)

This field determines when to activate the video off feature for monitor power management. The settings are *All Modes -> Off*; *Always On*; *Suspend -> Off*; and *Susp,Stby -> Off*.

IV. BIOS SOFTWARE

Video Off Method (DPMS OFF)

This field defines the video off features. The following options are available: *DPMS OFF*, *DPMS Reduce ON*, *Blank Screen*, *V/H SYNC+Blank*, *DPMS Standby*, and *DPMS Suspend*. The DPMS (Display Power Management System) features allow the BIOS to control the video display card if it supports the DPMS feature. *Blank Screen* only blanks the screen (use this for monitors without power management or “green” features. If set up in your system, your screen saver will not display with *Blank Screen* selected). *V/H SYNC+Blank* blanks the screen and turns off vertical and horizontal scanning.

.....

PM Timers

This section controls the time-out settings. The fields included in this section are **HDD Power Down**, which places the hard disk into its lowest power consumption mode, and the **Doze**, **Standby** and **Suspend** system inactivation modes. The system automatically “wakes up” from any power saving mode when there is system activity, such as when a key is pressed from the keyboard, or when there is activity detected from the enabled IRQ channels.

HDD Power Down (Disable)

This shuts down any IDE hard disk drives in the system after a period of inactivity, configurable to *1-15 Mins* or *Disable*. This feature does not affect SCSI hard disks.

Doze Mode, Standby Mode, Suspend Mode (Disable)

These fields set the period of time after which each of these modes activate: *30 Sec*, *1 Min*, *2 Min*, *4 Min*, *8 Min*, *20 Min*, *30 Min*, *40 Min*, *1 Hour*, and *Disable*.

.....

Power Up Control

This section determines the ways the system can be controlled when modem activity is detected, or when power to the computer is interrupted and reapplied.

Ring Power Up Act (Enable)

Allows either settings of *Enable* or *Disable* for powering up the computer (turns the ATX power supply on) when the modem begins receiving or transmitting data while the computer is off.

Automatic Power Up (Disable)

Allows you to have an unattended or automatic power up of your system. The default does not allow automatic power up. You may, however, configure your system to power up at a certain time of the day by selecting *Everyday*, which will allow you to set the time or at a certain time and day by selecting *By Date*.

.....

IRQ3 (device)-IRQ15 (device)

You can individually *Enable* or *Disable* each IRQ to include in the sleep function. IRQ8 (RTC Alarm) is usually set to *Disable* so that any software alarm clock or event calendar can wake up the system.

IV. BIOS SOFTWARE

Fan Monitor (xxxxRPM)

The onboard hardware monitor is able to detect the Chassis Fan Speed, CPU Fan Speed, and the Power Supply Fan Speed in Rotations Per Minute (RPM). These values refresh upon any key entries in the BIOS setup screen. Set to *Ignore* if one of these are not used so that error messages will not be given.

Thermal Monitor (xxxC/xxxF)

The onboard hardware monitor is able to detect the CPU and MB (motherboard) temperatures. These values refresh upon key entries. Set to *Ignore* only if necessary.

Voltage Monitor (xx.xV)

The onboard hardware monitor is able to detect the voltages put out by the voltage regulators. These values refresh upon key entries. Set to *Ignore* only if necessary.

NOTE: If any of the monitored items are out of range, you will be prompted by this message: “Hardware Monitor found an error, enter POWER MANAGEMENT SETUP for details” The bottom of the screen will instruct you to: “Press **F1** to continue, **DEL** to enter SETUP”

PNP and PCI Setup

This “PNP and PCI Setup” option configures the PCI bus slots. All PCI bus slots on the system use INTA#, thus all installed PCI cards must be set to this value.

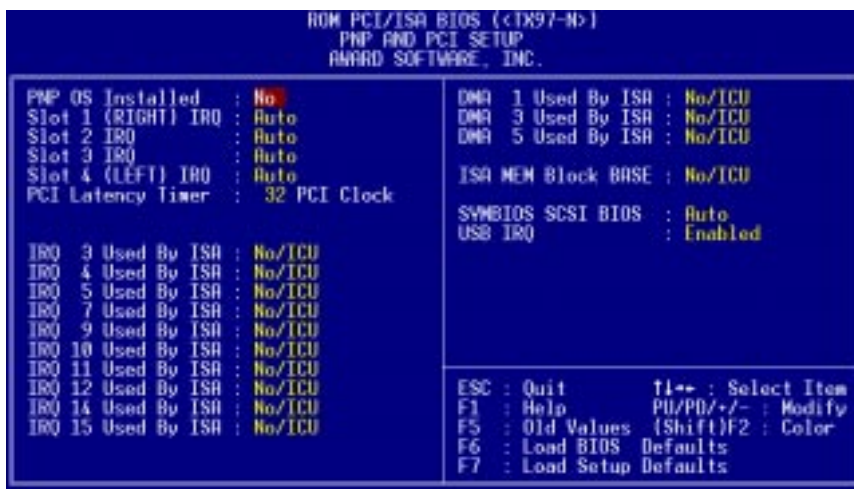

IV. BIOS
(PnP and PCI)

NOTE: SETUP Defaults are noted in parenthesis next to each function heading.

Details of PNP and PCI Setup

PNP OS Installed (No)

When Plug and Play operating systems (OS) are installed, interrupts may be reassigned by the OS when *Yes* is selected. When a non-Plug and Play OS is installed or to prevent reassigning of interrupt settings, select *No*.

IV. BIOS SOFTWARE

Slot 1/2/3/4 IRQ (Auto)

The first four fields on the screen set how IRQ use is determined for each PCI slot. Slot 1 (Right) is nearest the memory sockets. The default setting for each field is *Auto*, which uses autorouting to determine IRQ use. The other options are the manual settings of *NA*, *5*, *7*, *9*, *10*, *11*, *12*, *14*, or *15* for each slot.

PCI Latency Timer (32 PCI Clock)

The default setting of *32 PCI Clock* enables maximum PCI performance for this motherboard.

IRQ xx Used By ISA (No/ICU)

These fields indicate whether or not the displayed IRQ for each field is being used by a legacy (non-PnP) ISA card. Two options are available: *No/ICU* and *Yes*. The first option, the default value, indicates either that the displayed IRQ is not used or an ISA Configuration Utility (ICU) is being used to determine if an ISA card is using that IRQ. If you install a legacy (non-PnP) ISA card that requires a unique IRQ, and you are not using an ICU, you must set the field for that IRQ to *Yes*. For example: If you install a legacy ISA card that requires IRQ 10, then set **IRQ10 Used By ISA** to *Yes*.

.....

DMA x Used By ISA (No/ICU)

These fields indicate whether or not the displayed DMA channel for each field is being used by a legacy ISA card. Available options include: *No/ICU* and *Yes*. The first option, the default setting, indicates either that the displayed DMA channel is not used or an ICU is being used to determine if an ISA card is using that channel. If you install a legacy ISA card that requires a unique DMA channel, and you are not using an ICU, you must set the field for that channel to *Yes*.

ISA MEM Block BASE (No/ICU)

This field allows you to set the base address and block size of a legacy ISA card that uses any memory segment within the C800, CC00, D000, D400, D800, and DC00 address range. If you have such a card, and you are not using an ICU to specify its address range, select a base address from the six available options; the **ISA MEM Block SIZE** field will then appear for selecting the block size. If you have more than one legacy ISA card in your system that requires to use this address range, you can increase the block size to either 8K, 16K, 32K, or 64K. If you are using an ICU to accomplish this task, leave **ISA MEM Block BASE** to its default setting of *No/ICU*.

SYMBIOS SCSI BIOS (Auto)

The default uses *Auto* settings for the onboard SCSI BIOS. If you do not want to use the onboard SCSI BIOS, choose *Disabled*.

USB Function (Disabled)

The motherboard supports Universal Serial Bus (USB) devices but current operating systems do not. The default is set to *Disabled*. If you have the necessary support disks and USB devices, set this function to *Enabled* to use the onboard USB connector.

USB IRQ (Auto)

When USB devices are connected to the onboard USB connector, the resource settings or IRQs for these devices are, by default, automatically assigned by the BIOS. You may manually select the settings: *5*, *7*, *9*, *10*, *11*, *12*, *14*, and *15*. If you are not using any USB devices, you may set this field to *N/A*.

IV. BIOS SOFTWARE

Load BIOS Defaults

This “Load BIOS Defaults” option allows you to load the troubleshooting default values permanently stored in the BIOS ROM. These default settings are non-optimal and disable all high performance features. To load these default settings, highlight “Load BIOS Defaults” on the main screen and then press <Enter>. The system displays a confirmation message on the screen. Press <Y> and then <Enter> to confirm. Press <N> and then <Enter> to abort. This feature does not affect the fields on the Standard CMOS Setup screen.

Load Setup Defaults

This “Load Setup Defaults” option allows you to load the default values to the system configuration fields. These default values are the optimized configuration settings for the system. To load these default values, highlight “Load Setup Defaults” on the main screen and then press <Enter>. The system displays a confirmation message on the screen. Press <Y> and then <Enter> to confirm. Press <N> and then <Enter> to abort. This feature does not affect the fields on the Standard CMOS Setup screen.



IV. BIOS SOFTWARE

Supervisor Password and User Password

These two options set the system passwords. “Supervisor Password” sets a password that will be used to protect the system and the Setup utility; “User Password” sets a password that will be used exclusively on the system. By default, the system comes without any passwords. To specify a password, highlight the type you want and then press <Enter>. A password prompt appears on the screen. Taking note that the password is case sensitive, and can be up to 8 alphanumeric characters long, type in your password and then press <Enter>. The system confirms your password by asking you to type it again. After setting a password, the screen automatically reverts to the main screen.



To implement the password protection, specify in the “Security Option” field of the BIOS Features Setup screen when the system will prompt for the password. If you want to disable either password, press <Enter> instead of entering a new password when the “Enter Password” prompt appears. A message confirms the password has been disabled.

NOTE: If you forget the password, see CMOS RAM in section III for procedures on clearing the CMOS.

IV. BIOS SOFTWARE

IDE HDD Auto Detection

This “IDE HDD Auto Detection” option detects the parameters of an IDE hard disk drive, and automatically enters them into the “Standard CMOS Setup” screen.

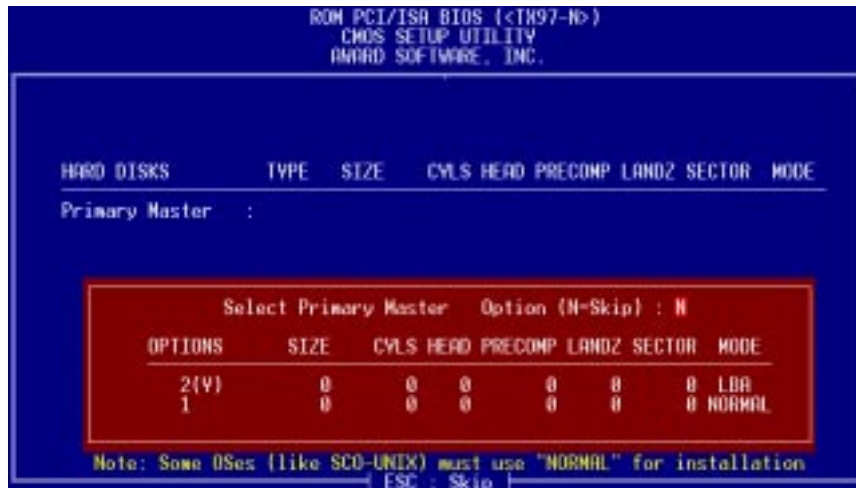

Up to four IDE drives can be detected, with parameters for each listed inside the box. To accept the optimal entries, press <Y>, otherwise select from the numbers displayed under the OPTIONS field (2, 1, 3 in this case); to skip to the next drive, press <N>. If you accept the values, the parameters will appear listed beside the drive letter on the screen. The process then proceeds to the next drive letter. Pressing <N> to skip rather than to accept a set of parameters causes the program to enter zeros after that drive letter.

If you are using another IDE controller that does not feature Enhanced IDE support for four devices, you can only install two IDE hard disk drives. Your IDE controller must support the Enhanced IDE features to use Drive E and Drive F. The onboard PCI IDE controller supports Enhanced IDE, with two connectors for connecting up to four IDE devices. If you want to use another controller that supports four drives, you must disable the onboard IDE controller in the Chipset Features Setup screen.

When autodetection is completed, the program automatically enters all entries you accepted on the field for that drive in the “Standard CMOS Setup” screen. Skipped entries are ignored and are not entered in the screen.

If you are autodetecting a hard disk that supports the LBA mode, three lines will appear in the parameter box. Choose the line that lists LBA for an LBA drive. Do not select Large or Normal.

The autodetection feature can only detect one set of parameters for a particular IDE hard disk. Some IDE drives can use more than one set. This is not a problem if the drive is new and there is nothing on it.

IV. BIOS SOFTWARE

IMPORTANT: If your hard disk was already formatted on an older previous system, incorrect parameters may be detected. You will need to enter the correct parameters manually or use low-level format if you do not need the data stored on the hard disk.

If the parameters listed differ from the ones used when the drive was formatted, the drive will not be readable. If the autodetected parameters do not match the ones that should be used for your drive, do not accept them. Press <N> to reject the presented settings and enter the correct ones manually from the “Standard CMOS Setup” screen.

Save and Exit Setup

Select this option to save into the CMOS memory all modifications you specify during the current session. To save the configuration changes, highlight “Save & Exit Setup” on the main screen, type “Y”, and then press <Enter>.



Exit Without Saving

Select this option to exit the Setup utility without saving the modifications you specify during the current session. To exit without saving, highlight “Exit Without Saving” on the main screen, type “Y”, and then press <Enter>.

V. SUPPORT SOFTWARE

Desktop Management Interface (DMI)

Introducing the ASUS DMI Configuration Utility

This motherboard supports DMI within the BIOS level and provides a DMI Configuration Utility to maintain the Management Information Format Database (MIFD). DMI is able to autodetect and record information pertinent to a computer's system such as the CPU type, CPU speed, and internal/external frequencies, and memory size. The onboard BIOS will detect as many system information as possible and store those collected information in a 4KB block in the motherboard's Flash EPROM and allow the DMI to retrieve data from this database. Unlike other BIOS software, the BIOS on this motherboard uses the same technology implemented for Plug and Play to allow dynamic real-time updating of DMI information versus creating a new BIOS image file and requiring the user to update the whole BIOS. This DMI Configuration Utility also allows the system integrator or end user to add additional information into the MIFD such as serial numbers, housing configurations, and vendor information. Those information not detected by the motherboard BIOS and has to be manually entered through the DMI Configuration Utility and updated into the MIFD. This DMI Configuration Utility provides the same reliability as PnP updating and will prevent the refreshing failures associated with updating the entire BIOS.

System Requirements

The DMI Configuration Utility (DMICFG.EXE) must be used in real mode in order for the program to run, the base memory must be at least 180K. Memory managers like HIMEM.SYS (required by windows) must not be installed. You can boot up from a system diskette without AUTOEXEC.BAT and CONFIG.SYS files, "REM" HIMEM.SYS in the CONFIG.SYS, or press <F5> during bootup to bypass your AUTOEXEC.BAT and CONFIG.SYS files.

V. SUPPORT SOFTWARE

Using the ASUS DMI Configuration Utility

Edit DMI (or delete)

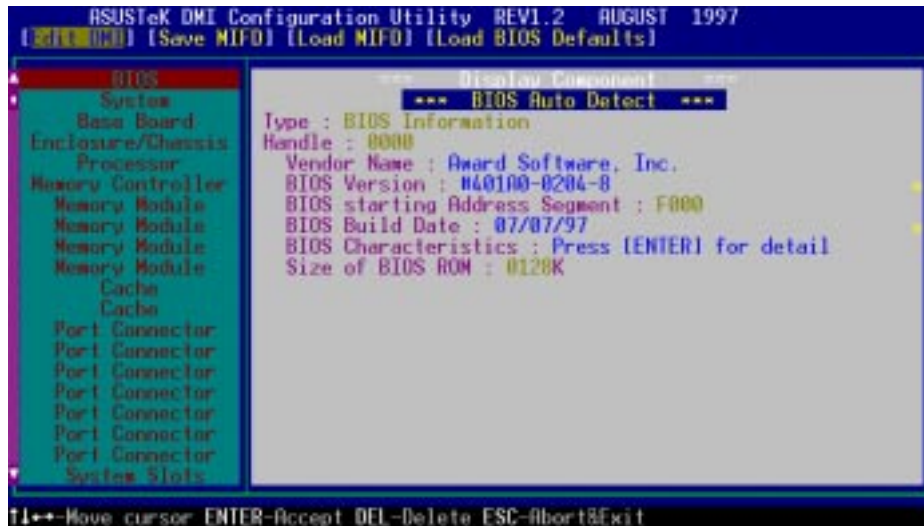

Use the ←→ (left-right) cursors to move the top menu items and the ↑↓ (up-down) cursor to move between the left hand menu items. The bottom of the screen will show the available keys for each screen. Press enter at the menu item to enter the right hand screen for editing. “Edit component” appears on top. The reversed color field is the current cursor position and the blue text are available for editing. The orange text shows autodetected information and are not available for editing. The blue text “Press [ENTER] for detail” contains a second pop-up menu is available, use the + - (plus-minus) keys to change the settings. Enter to exit *and save*, ESC to exit *and not save*.

If the user has made changes, ESC will prompt you to answer Y or N. Enter Y to go back to the left-hand screen *and save*, enter N to go back to left-hand screen and *not save*. If editing has not been made, ESC will send you back to the left hand menu without any messages.

Notes

A heading, ***** BIOS Auto Detect *****, appears on the right for each menu item on the left side that has been auto detected by the system BIOS.

A heading, ***** User Modified *****, will appear on the right for menu items that has been modified by the user.



V. SUPPORT SOFTWARE

Save MIFD

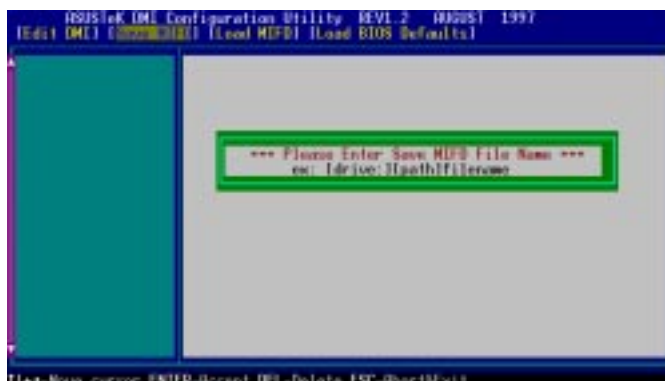

You can save the MIFD (normally only saved to flash ROM) to a file by entering the drive and path here. If you want to cancel save, you may press ESC and a message “Bad File Name” appears here to show it was not saved.

Load MIFD



You can load the disk file to memory by entering a drive and path and file name here.

Load BIOS Defaults

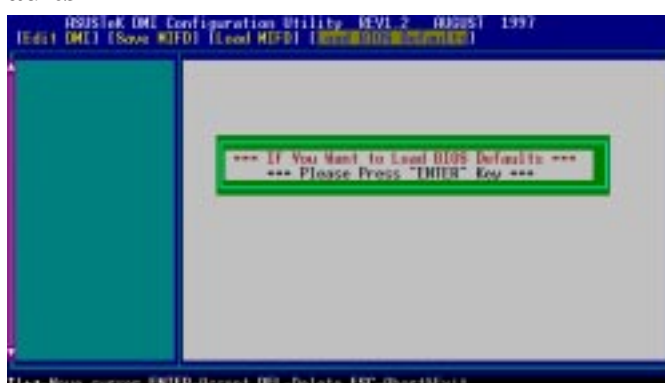

You can load the BIOS defaults from a MIFD file and can clear all user modified and added data. You must reboot your computer in order for the defaults to be saved back into the Flash BIOS.

VI. ASUS PCI SCSI Cards

Symbios SCSI BIOS and Drivers

Aside from the system BIOS, the Flash memory chip on the motherboard also contains the Symbios SCSI BIOS. This Symbios SCSI BIOS works in conjunction with the optional ASUS PCI-SC200 controller card to provide Fast SCSI-2 interface when using compatible SCSI devices or the ASUS PCI-SC860 SCSI controller cards to provide Ultra-Fast SCSI-2 interface when using Ultra-Fast SCSI-2 devices.

All SCSI devices you install on your system require driver software to function. The Symbios SCSI BIOS directly supports SCSI hard disks under the DOS, Windows and OS/2 environments. It also uses device drivers from the DOS floppy disk included in the ASUS PCI-SC200 and ASUS PCI-SC860 controller card packages to support hard disks and other SCSI devices working under DOS, Microsoft Windows, Microsoft Windows NT, Novell NetWare and IBM OS/2. These drivers provide higher performance than the direct BIOS support. To use these drivers, you must install them into your system and add them to your system configuration files. Driver support for SCSI devices used with SCO UNIX is also provided. These drivers are included in the second SCO UNIX floppy disk. Windows 95 support is also available using the device drivers included within the Windows software. The ASUS PCI-SC200 and ASUS PCI-SC860 are Plug and Play adapters that are auto detected by BIOS and current operating systems that support Plug and Play features.

For information about these drivers and their usage, please view the Readme files included in the driver packages.

ASUS PCI-SC200 & PCI-SC860 SCSI Cards

The ASUS PCI-SC200 or the ASUS PCI-SC860 may be bundled with your motherboard or purchased separately. Both cards provide the option of connecting internal or external SCSI devices for a total of 7 devices on each SCSI card.

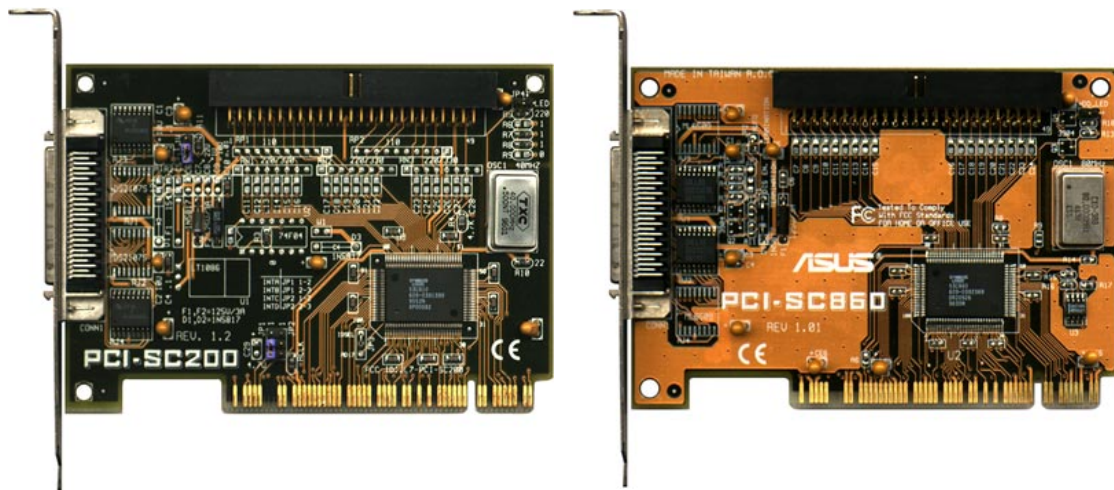

VI. ASUS PCI SCSI Cards

Setting Up the ASUS PCI-SC200 & PCI-SC860

There are two jumper settings you may need to make on the ASUS PCI-SC200 to set it up. One setting assigns the PCI INT interrupt, the other sets the card's termination. The ASUS PCI-SC860 has no jumper settings but you should read the "Terminator Requirements."

Setting the INT Assignment for the ASUS PCI-SC200

You must use PCI INT A setting in order to properly assign the ASUS PCI-SC200's interrupt. On the ASUS PCI-SC200, you assign the INT by setting jumper JP1 or JP2. The default setting for the card already is INT A, so you do not need to change the setting to use the ASUS PCI-SC200 with this motherboard.

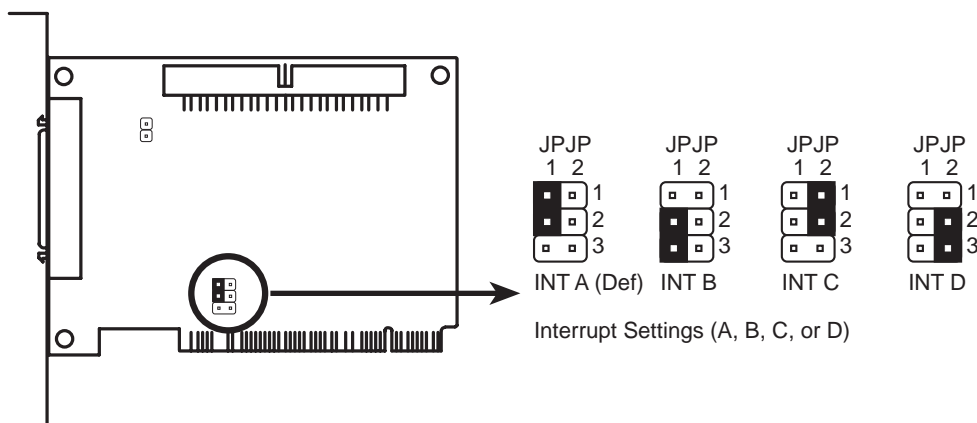

Terminator Requirements for SCSI Devices

SCSI devices are connected together in a "chain" by cables. Internal devices connect to the ASUS PCI-SC200 or ASUS PCI-SC860 with a fifty-pin flat ribbon cable. External devices connect to the external port with a SCSI-2 cable. If there are more than one internal or external devices, additional devices are connected with cables to form a "daisy chain." Terminating the devices on the ends of the SCSI Bus "chain" is necessary for SCSI devices to work properly. Termination of the devices between the ends must be *Disabled*.

VI. ASUS PCI SCSI Cards

Setting Up the ASUS PCI-SC200 & PCI-SC860

There are two jumper settings you may need to make on the ASUS PCI-SC200 to set it up. One setting assigns the PCI INT interrupt, the other sets the card's termination. The ASUS PCI-SC860 has no jumper settings but you should read the "Terminator Requirements."

Setting the INT Assignment for the ASUS PCI-SC200

You must use PCI INT A setting in order to properly assign the ASUS PCI-SC200's interrupt. On the ASUS PCI-SC200, you assign the INT by setting jumper JP1 or JP2. The default setting for the card already is INT A, so you do not need to change the setting to use the ASUS PCI-SC200 with this motherboard.

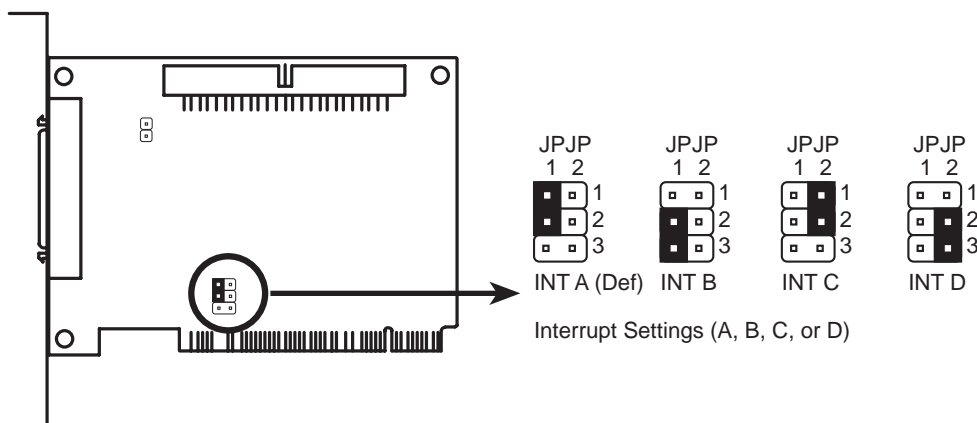

Terminator Requirements for SCSI Devices

SCSI devices are connected together in a "chain" by cables. Internal devices connect to the ASUS PCI-SC200 or ASUS PCI-SC860 with a fifty-pin flat ribbon cable. External devices connect to the external port with a SCSI-2 cable. If there are more than one internal or external devices, additional devices are connected with cables to form a "daisy chain." Terminating the devices on the ends of the SCSI Bus "chain" is necessary for SCSI devices to work properly. Termination of the devices between the ends must be *Disabled*.

VI. ASUS PCI SCSI Cards

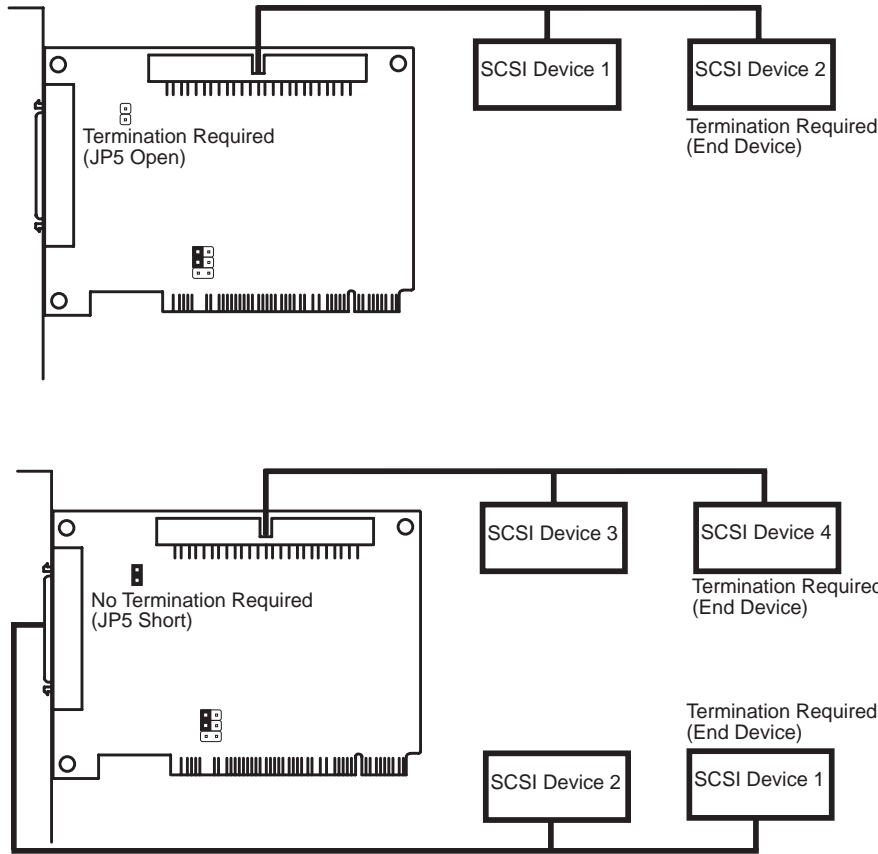

SCSI ID Numbers for SCSI Devices

All SCSI devices, including the ASUS PCI-SC200 and ASUS PCI-SC860 interface card must have a SCSI identification number that is not in use by any other SCSI device. There are eight possible ID numbers, 0 through 7. The ASUS PCI-SC200 and ASUS PCI-SC860 cards have fixed SCSI IDs of 7. The SCSI ID serves two purposes:

- It uniquely defines each SCSI device on the bus.
- It determines which device controls the bus when two or more devices try to use it at the same time.

SCSI IDs on one channel do not interfere with the IDs on another channel. This applies to two SCSI host adapters that implement different buses as well as dual channels on a single host adapter. You can connect up to seven SCSI devices to the interface card. You must set a SCSI ID number (ID 0 to ID 6) for each device. SCSI devices vary in how they set the ID number. Some use jumpers, others have some kind of selector switch. Refer to the manual for any device you install for details on how to set its ID number.

SCSI ID Priority

The ASUS PCI-SC200 and ASUS PCI-SC860 are 8bit single-channel SCSI cards. SCSI ID 7 has the highest priority, and SCSI ID 0 has the lowest priority.

VII. ASUS LAN Card

ASUS PCI-L101 Fast Ethernet Card

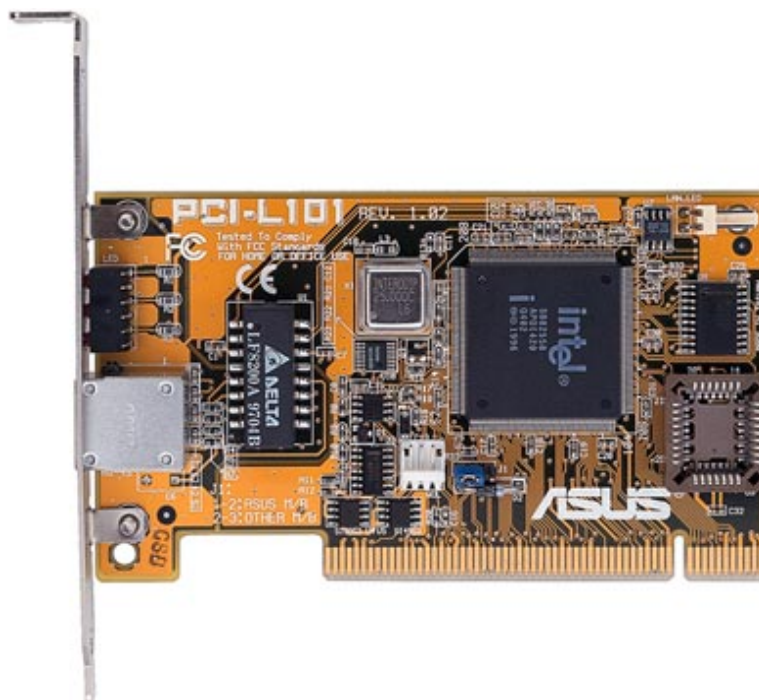

VII. ASUS LAN Card
(Parts / Layout)

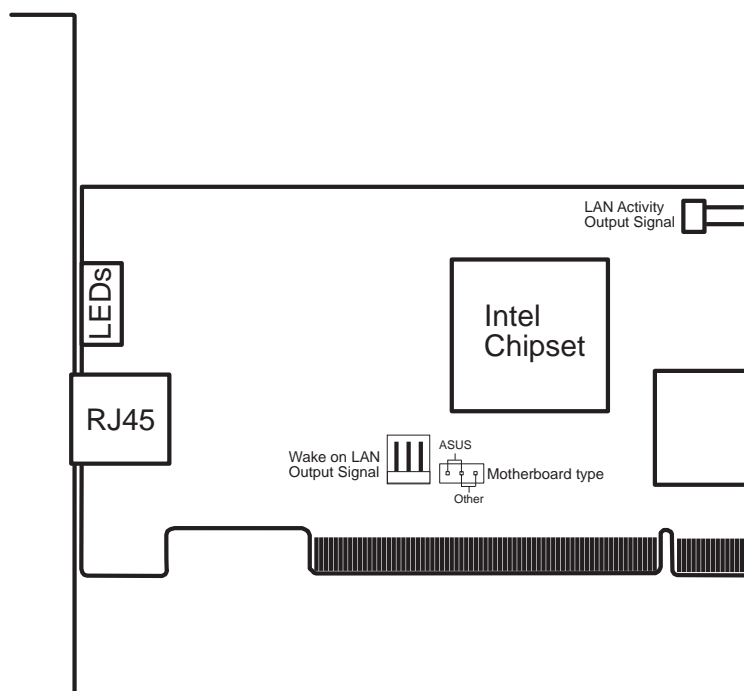

If you are using the ASUS PCI-L101 on an ASUS motherboard, leave the jumper on its default setting of “ASUS.” If you are using another brand of motherboard, set the jumper to “Other.” Connect the Wake on LAN (WOL) output signal to the riser card’s WOL_CON in order to utilize the wake on LAN feature of the motherboard. Connect the LAN activity output signal (LAN_LED) to the riser card’s LAN_LED in order to display the LAN data activity on the system’s front panel LED.

VII. ASUS LAN Card

Features

- Intel 82558 Ethernet LAN Controller (Fully integrated 10BASE-T/100BASE-TX)
- Wake-On-LAN Remote Control Function Supported
- PCI Bus Master Complies to PCI Rev. 2.1
- Consists of MAC & PHY (10/100Mbps) interfaces
- Complies to IEEE 802.3 10BASE-T and IEEE 802.3U 100BASE-TX interfaces
- Fully supports 10BASE-T & 100BASE-TX operations
- Single RJ-45 Connector: Auto-Detection of 10Mbps or 100Mbps Network Data Transfer Rates and Connected Cable Types
- 32 bit Bus Master Technology / PCI Rev. 2.1
- Plug and Play
- Enhancements on ACPI & APM
- Adheres to PCI Bus Power Management Interface Rev. 1.0, ACPI Rev. 1.0, and Device Class Power Management Rev. 1.0

Drivers Supported

- Novell Netware ODI Server 3.X, 4.X, DOS, OS/2 Client
- NDIS 2.01 for MS LAN Manager, WfW, IBM LAN Server
- NDIS 3.0 for MS Windows NT, WfW 3.11, Windows 95
- SCO UNIX Streams

Question and Answer

Q: What is Wake-On-LAN ?

A: The Wake-On-LAN feature provides the capability to remotely power on systems supporting Wake-On-LAN by simply sending a wake-up frame. With this feature, remotely uploading/downloading data to/from systems during off-peak hours will be feasible.

Q: What can Wake-On-LAN do for you ?

A: Wake-On-LAN is a remote management tool with advantages that can reduce system management workload, provide flexibility to the system administrator's job, and then of course save you time-consuming efforts and costs.

Q: What components does Wake-On-LAN require to be enable?

A: To enable Wake-On-LAN function, your system requires Ethernet LAN adapter card that can activate Wake-On-LAN function, a client with Wake-On-LAN capability, and software such as LDCM Rev. 3.10 or up that can trigger wake-up frame.