

TI5VGS+
Pentium MVP3
ATX Motherboard
User's Manual
Version 1.0

Contents

Chapter 1 Introduction.....	1
Chapter 2 Specifications	3
Chapter 3 Hardware Description	5
3.1 Processor and CPU Voltage	7
3.2 L2 Cache Memory.....	7
3.3 Main Memory.....	7
3.4 BIOS	9
3.5 Onboard PCI EIDE	10
3.6 Onboard Multi-I/O	10
3.7 Onboard Hardware Monitoring IC	10
3.8 I/O Port Address Map	11
3.9 DMA Channels.....	11
3.10 Interrupt Request Lines (IRQ).....	12
3.11 Accelerated Graphics Port (AGP) Slot.....	12
Chapter 4 Hardware Settings.....	13
4.1 SW1(1-8): CPU Frequency Selector	15
4.2 JP1: DRAM Operating Frequency	18
4.3 SW2(1-4): CPU Voltage Selector	18
4.4 JP5: Clear CMOS Selection	20
Chapter 5 Installation	21
5.1 I/O Connectors	23
5.2 J1: PS/2 Keyboard and PS/2 Mouse Connectors.....	23
5.3 J2: USB Connector.....	24
5.4 J3, J5 Serial Ports.....	24
5.5 J4: Parallel Port Connector	25
5.6 J6: ATX Power Supply Connector.....	25
5.7 J7: Floppy Drive Connector	26
5.8 IDE1, IDE2: EIDE Connectors	27
5.9 J8: CPU Fan Power Connector.....	28
5.10 J9: IrDA Connector.....	28
5.11 J10 Wake on LAN Connector	28
5.12 J12: Chassis Fan Power Connector	28
5.13 J13 Front Bezel Connector.....	29

Chapter 6 BIOS Configuration.....	31
6.1 BIOS Introduction	34
6.2 BIOS Setup.....	34
6.3 Standard CMOS Setup	36
6.4 BIOS Features Setup	39
6.5 Chipset Features Setup	42
6.6 Power Management Setup	44
6.7 PNP/PCI Configuration	47
6.8 Load BIOS Defaults	50
6.9 Load Setup Defaults	50
6.10 Integrated Peripherals.....	51
6.11 Supervisor / User Password.....	53
6.12 IDE HDD Auto Detection	54
6.13 HDD Low Level Format.....	54
6.14 Save & Exit Setup	55
6.15 Exit Without Saving	55
Chapter 7 System Monitor User's Guide	56

Chapter 1 Introduction

This manual is designed to give you information on the TI5VGS+ Motherboard. It is divided into the following sections:

- **Introduction**
- **Specifications**
- **Hardware Description**
- **Hardware Settings**
- **Installation**
- **BIOS Configuration**
- **System Monitor User's Guide**

Checklist

Please check that your package is complete and contains the items below. If you discover damaged or missing items, please contact your dealer.

- ✧ **The TI5VGS+ Motherboard**
- ✧ **This user's manual**
- ✧ **1 IDE ribbon cable**
- ✧ **1 floppy ribbon cable**
- ✧ **1 CD containing Bus Master IDE drivers, flash utility, other drivers and System Monitor utility. The LANdesk Client Manager software is optional.**

This page is intentionally left blank.

Chapter 2 Specifications

Based on VIA's MVP3 chipset, the TI5VGS+ is an ATX Pentium motherboard that supports all the features to make a Microsoft PC'97 compliant PCI/ISA system. *The MVP3 (82C598AT) chipset provides a maximum CPU bus speed of 100MHz.*

The TI5VGS+ comes with 32MB or 64MB of PC-100 compliant SDRAM on board and Accelerated Graphics Port (AGP) slot, power management functionality that is compliant with ACPI (Advanced Configuration and Power Interface) and legacy APM requirements. In addition to standard PIO and DMA mode operation, it features Ultra DMA/33 for improved disk I/O throughput. The main features of this motherboard are listed as follows:

Main Processor

- Intel Pentium 90/100/120/133/150/166/200
- Intel Pentium MMX (P55C) 90/100/120/133/150/166/200/233
- Cyrix 6x86/6x86L P150+/P166+/P200+
- Cyrix 6x86MX PR166/PR200/PR233/PR266
- Cyrix 6x86MII PR266/PR300/PR333/PR350
- AMD K5 PR100/PR133/PR166
- AMD K6 166/200/233/266/300
- AMD K6-2/266/300/333/350/400
- IDT WinChip C6 180/200/225MHz
- IDT WinChip2-3D C6 200/225/266MHz

L2 Cache

512KB or 1MB Pipelined Burst Synchronous SRAM onboard

Main Memory

- Two 168-pin DIMM sockets
- 32MB or 64MB PC-100 compliant SDRAM on board
- DIMMs:** SDRAM (Synchronous DRAM)
- DIMM Size:** 8MB, 16MB, 32MB, 64MB, 128MB

Chipset

VIA's MVP3 chipset with built-in PCI EIDE

Onboard I/O

Winbond W83877 for two serial, one parallel, one floppy drive interface and IrDA support

Onboard Bus Mastering EIDE

Two EIDE interfaces for up to four devices, support PIO Mode 3/4 or Ultra DMA/33 IDE Hard Disk and ATAPI CD-ROM.

BIOS

Licensed BIOS with additional features:

- FLASH EEPROM (128KB) for BIOS update
- ISA Plug and Play (PnP) extension
- Power management

Hardware Monitoring IC

The Winbond W83781D hardware monitoring IC on the motherboard monitors the system temperature, voltages and fan speed. With the use of a system management utility, the hardware status can be checked and a warning message can be displayed when there is a problem.

Windows 95 Shut-Down

This allows the PC to power off via Windows 95 operating system.

PC97 Compliance

The TI5VGS+ implements BIOS and hardware designs that meet PC97 standards and is fully compatible with all Windows operating systems.

Year 2000 Compliant BIOS

The onboard Award BIOS is Year 2000 Compliant and will pass software applications that have the tendency to invoke INT1AH function 04H such as year2000.exe utility released by NSTL.

Expansion Slots

Five 32-bit PCI slots
Two 16-bit ISA slots
One AGP slot (Accelerated Graphics Port)

Form Factor

ATX, 12"x 7.1" (30.5cm x 18cm)

Chapter 3 Hardware Description

This chapter briefly describes each of the major features of the TI5VGS+ motherboard. The layout of the board is shown in Figure 1, which shows the locations of the key components. The topics covered in this chapter are as follows:

3.1 Processor and CPU Voltage	7
3.2 L2 Cache Memory.....	7
3.3 Main Memory.....	7
3.4 BIOS	9
3.5 Onboard PCI EIDE	10
3.6 Onboard Multi-I/O	10
3.7 Onboard Hardware Monitoring IC.....	10
3.8 I/O Port Address Map	11
3.9 DMA Channels.....	11
3.10 Interrupt Request Lines (IRQ).....	12
3.11 Accelerated Graphics Port (AGP) Slot.....	12

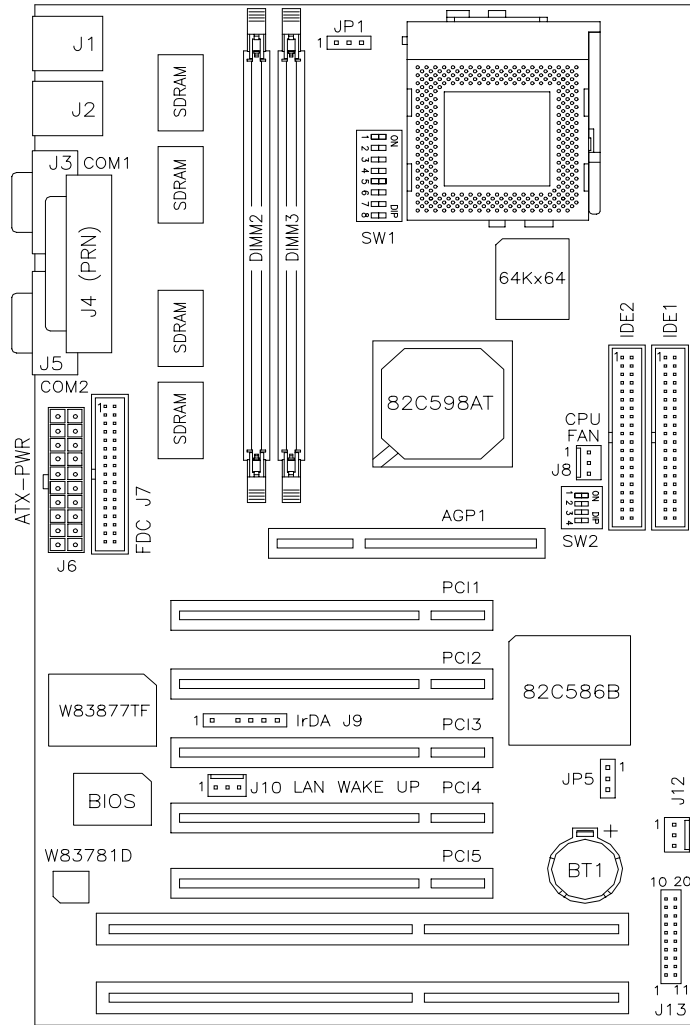

Figure 1: Layout of the TI5VGS+ Motherboard

3.1 Processor and CPU Voltage

The TI5VGS+ is designed to take a Pentium Processor with a bus speed of 60, 66, 75, 83, 95 and 100 MHz. The internal clock of the CPU can be multiples of 1.5, 2, 2.5, 3, 3.5, 4 and 4.5 of the bus clock. The CPU frequency can be 90 to 450MHz.

The onboard CPU voltage regulator provides support for CPUs Vcore which require voltage other than 3.3V such as 2.8V, and/or power consumption higher than 10 watts.

3.2 L2 Cache Memory

The TI5VGS+ supports 512KB or 1MB Pipelined Burst (P.B.) Synchronous Cache. The P.B. Synchronous Cache boosts the system's performance, 10% higher than regular Asynchronous Cache.

3.3 Main Memory

The TI5VGS+ motherboard supports two 168-pin DIMMs (Dual In-line Memory Module) sockets and 32MB or 64MB PC-100 compatible SDRAM on board. DIMM modules can be 8MB, 16MB, 32MB, 64MB and 128MB SDRAM type.

(1) 168-pin DIMM (3.3V) - SDRAM

SDRAM Onboard	Bank1 (DIMM2)	Bank2 (DIMM3)	Total Memory
32MB	8MB	-----	40MB
32MB	8MB	8MB	48MB
32MB	8MB	16MB	56MB
32MB	8MB	32MB	72MB
32MB	8MB	64MB	104MB
32MB	8MB	128MB	168MB
32MB	16MB	-----	48MB
32MB	16MB	16MB	64MB
32MB	16MB	32MB	80MB
32MB	16MB	64MB	112MB
32MB	16MB	128MB	176MB
32MB	32MB	-----	64MB
32MB	32MB	32MB	96MB
32MB	32MB	64MB	128MB
32MB	32MB	128MB	160MB
32MB	64MB	-----	192MB
32MB	64MB	64MB	160MB
32MB	64MB	128MB	224MB
32MB	128MB	-----	160MB
32MB	128MB	128MB	288MB
64MB	8MB	-----	72MB
64MB	8MB	8MB	80MB
64MB	8MB	16MB	88MB
64MB	8MB	32MB	104MB
64MB	8MB	64MB	136MB
64MB	8MB	128MB	200MB

64MB	16MB	-----	80MB
64MB	16MB	16MB	96MB
64MB	16MB	32MB	112MB
64MB	16MB	64MB	144MB
64MB	16MB	128MB	208MB
64MB	32MB	-----	96MB
64MB	32MB	32MB	128MB
64MB	32MB	64MB	160MB
64MB	32MB	128MB	224MB
64MB	64MB	-----	128MB
64MB	64MB	64MB	192MB
64MB	64MB	128MB	256MB
64MB	128MB	-----	192MB
64MB	128MB	128MB	320MB

3.4 BIOS

The BIOS on the TI5VGS+ motherboard provides the standard BIOS functions plus the following additional features:

1. ISA Plug and Play (PnP) Extension

Unlike PCI cards which are plug and play, ISA cards require setting jumpers to resolve hardware conflicts. To make a computer system PnP, an ISA PnP standard is established and supported by new OSes, such as Windows 95. Under Windows 95, the motherboard BIOS must have ISA PnP extension to support the new ISA PnP cards.

2. Power Management

The power management feature provides power savings by slowing down the CPU clock, turning off the monitor screen and stopping the HDD spindle motor.

3.5 Onboard PCI EIDE

The PCI EIDE controller is part of the MVP3 chipset. It supports PIO mode 3/4 and bus mastering. The peak transfer rate of PIO mode 3/4 can be as high as 17MB/sec. Using HDDs that support bus mastering, the peak transfer rate can reach 22MB/sec. There are two IDE connectors, primary IDE and secondary IDE. With two devices per connector, up to four IDE drives are supported. The MVP3 also supports Ultra DMA/33, a new “synchronous DMA” protocol for faster data transfers.

3.6 Onboard Multi-I/O

The onboard multi-I/O chip, Winbond W83877, supports two 16550 UART-compatible serial ports, one high speed EPP/ECP parallel port and one floppy controller. The floppy controller supports 2.88MB format. The I/O port addresses of the serial and parallel ports are programmable via BIOS set-up.

3.7 Onboard Hardware Monitoring IC

The Winbond W83781D hardware monitoring IC on the motherboard monitors the system temperature, voltages and fan speed. With the use of a system management utility, the hardware status can be checked and warning message can be displayed when there is a problem.

3.8 I/O Port Address Map

Each peripheral device in the system is assigned a set of I/O port addresses which also becomes the identity of the device. There is a total of 1K port address space available. The following table lists the I/O port addresses used on the motherboard.

Address	Device Description
000h - 01Fh	DMA Controller #1
020h - 03Fh	Interrupt Controller #1
040h - 05Fh	Timer
060h - 06Fh	Keyboard Controller
070h - 07Fh	Real Time Clock, NMI
080h - 09Fh	DMA Page Register
0A0h - 0BFh	Interrupt Controller #2
0C0h - 0DFh	DMA Controller #2
0F0h	Clear Math Coprocessor Busy Signal
0F1h	Reset Math Coprocessor
1F0h - 1F7h	IDE Interface
278 - 27F	Parallel Port #2 (LPT2)
2F8h - 2FFh	Serial Port #2 (COM2)
2B0 - 2DF	Graphics adapter Controller
378h - 3FFh	Parallel Port #1(LPT1)
360 - 36F	Network Ports
3B0 - 3BF	Monochrome & Printer adapter
3C0 - 3CF	EGA adapter
3D0 - 3DF	CGA adapter
3F0h - 3F7h	Floppy Disk Controller
3F8h - 3FFh	Serial Port #1 (COM1)

3.9 DMA Channels

There are seven DMA Channels available on the motherboard; only DMA2 is used by the floppy controller. In the case that ECP mode on the parallel port is used, DMA1 or DMA3 will be used.

3.10 Interrupt Request Lines (IRQ)

There are a total of 15 IRQ lines available on the motherboard. Peripheral devices use interrupt request lines to notify the CPU for the service required. The following table shows the IRQ used by the devices on the motherboard.

Level	Function
IRQ0	System Timer Output
IRQ1	Keyboard
IRQ2	Interrupt Cascade
IRQ3	Serial Port #2
IRQ4	Serial Port #1
IRQ5	Parallel Port #2
IRQ6	Floppy Disk Controller
IRQ7	Parallel Port #1
IRQ8	Real Time Clock
IRQ9	Software Redirected to Int 0Ah
IRQ10	Reserved
IRQ11	Reserved
IRQ12	Reserved
IRQ13	80287
IRQ14	Primary IDE
IRQ15	Secondary IDE

3.11 Accelerated Graphics Port (AGP) Slot

The TI5VGS+ motherboard comes with an AGP slot for an AGP VGA card that supports 133MHz 2X mode for AD and SBA signaling to provide high-performance 3D graphic display.

Chapter 4 Hardware Settings

The following sections describe the necessary procedures and proper jumper settings to configure the TI5VGS+ motherboard.



- 4.1 SW1(1-8): CPU Frequency Selector 15
- 4.2 JP1: DRAM Operating Frequency 18
- 4.3 SW2(1-4): CPU Voltage Selector 18
- 4.4 JP5: Clear CMOS Selection 20

The TI5VGS+ supports VIA's MVP3 chipset and has a maximum CPU bus speed of 100MHz. Please note the correct settings of both the CPU and SDRAM clocks.

In case your motherboard, TI5VGS+, has a processor supporting 100MHz CPU clock (such as AMD K6-300) and your DIMM module is PC100 compliant, the SDRAM clock can be set to *Run CPU Clock*. Otherwise, set the SDRAM clock at *Run AGP Clock*.

For the locations of the jumpers, refer to Figure 2 on the following page.

The following examples show the conventions used in this chapter

	Jumper Open
	Jumper Closed

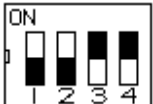
	<p>Switch 1 and switch 2 are set to OFF. Switch 3 and switch 4 are set to ON.</p>
-------------------------------------------------------------------------------------	---------------------------------------------------------------------------------------

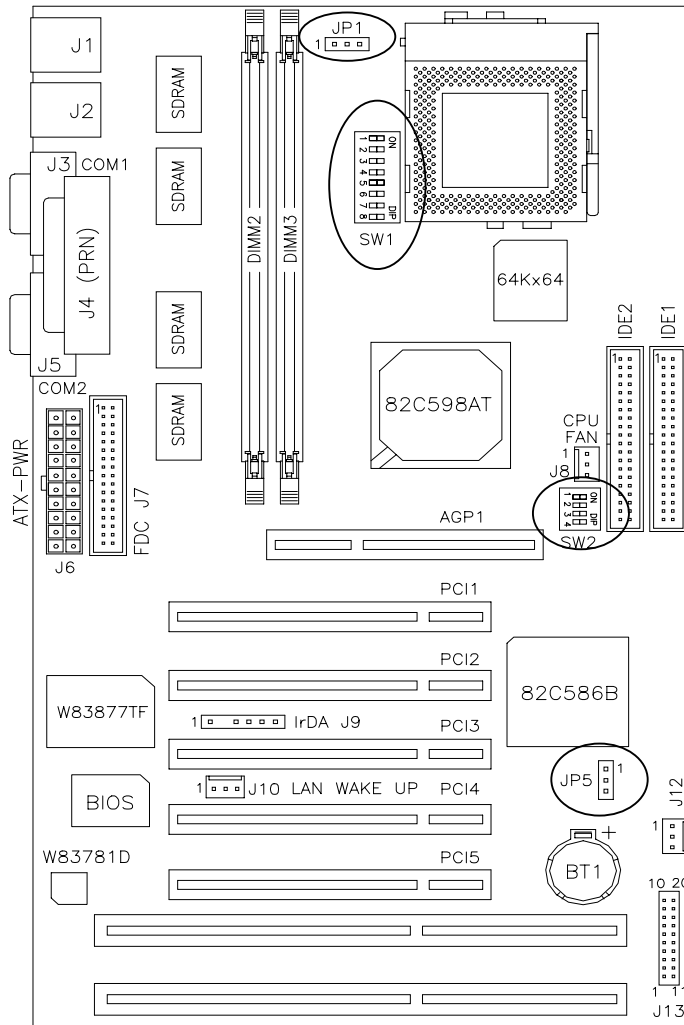

Figure 2: Jumper Locations of the TI5VGs+

4.1 SW1(1-8): CPU Frequency Selector

For Intel Pentium, IDT WinChip 2-3D / C6

SW1	CPU Clock	AGP Clock	Multiplier	CPU FREQ.
<p>ON 1 2 3 4 5 6 7 8 on on on off off off on on</p>	60MHz	60MHz	1.5x	P54C-90
<p>ON 1 2 3 4 5 6 7 8 off on on off off off on on</p>	66MHz	66MHz	1.5x	P54C-100
<p>ON 1 2 3 4 5 6 7 8 on on on on off on on on</p>	60MHz	60MHz	2x	P54C-120
<p>ON 1 2 3 4 5 6 7 8 off on on on off on on on</p>	66MHz	66MHz	2x	P54C-133
<p>ON 1 2 3 4 5 6 7 8 on on on on on on off on</p>	60MHz	60MHz	2.5x	P54C-150
<p>ON 1 2 3 4 5 6 7 8 off on on on on on on on</p>	66MHz	66MHz	2.5x	P54C/P55C-166
<p>ON 1 2 3 4 5 6 7 8 on on on off off on off on</p>	60MHz	60MHz	3x	C6-180
<p>ON 1 2 3 4 5 6 7 8 off on on off off on off on</p>	66MHz	66MHz	3x	P54C/P55C-200 WinChip 2-3D / C6-200
<p>ON 1 2 3 4 5 6 7 8 off on on off off off on on</p>	66MHz	66MHz	3.5x	P55C-233
<p>ON 1 2 3 4 5 6 7 8 off off on off off on on on</p>	75MHz	75MHz	3x	WinChip 2-3D / C6-225
<p>ON 1 2 3 4 5 6 7 8 off on on off off on off on</p>	66MHz	66MHz	4x	WinChip 2-3D 266

For Cyrix 6x86, 6x86L, 6x86MX. MII CPU

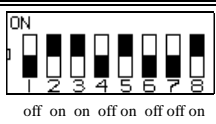
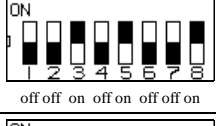
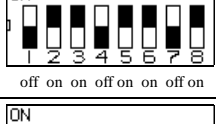
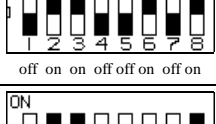
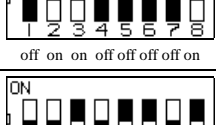
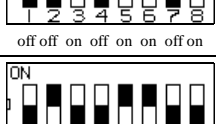
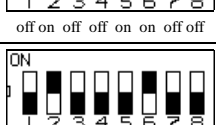
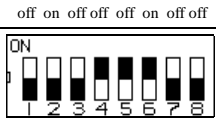
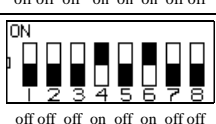
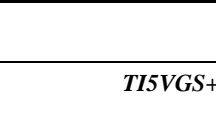
SW1	CPU Clock	AGP Clock	Multiplier	CPU FREQ.
 <p>off on on off on off off on</p>	66MHz	66MHz	2x	P166+ (133MHz)
 <p>off off on off on off off on</p>	75MHz	75MHz	2x	P200+ (150MHz)
 <p>off on on off on on off on</p>	66MHz	66MHz	2.5x	PR200 (166MHz)
 <p>off on on off off on off on</p>	66MHz	66MHz	3x	PR233 (200MHz)
 <p>off on on off off off off on</p>	66MHz	66MHz	3.5x	PR300 (233MHz)
 <p>off off on off on on on off</p>	75MHz	75MHz	2.5x	PR233 (187.5MHz)
 <p>off on off off on on on off</p>	83MHz	66MHz	2.5x	PR266 (208MHz)
 <p>off on off off off on off off</p>	83MHz	66MHz	3x	PR333 (250MHz)
 <p>off off off on on on off off</p>	100MHz	66MHz	2.5x	PR333 (250MHz)
 <p>off off off on off on off off</p>	100MHz	66MHz	3x	PR350 (300MHz)

For AMD K5, K6, K6-2 CPU

SW1	CPU Clock	AGP Clock	Multiplier	CPU FREQ.
<p>ON 1 2 3 4 5 6 7 8 on on on off off off off on</p>	60MHz	60MHz	1.5x	PR90
<p>ON 1 2 3 4 5 6 7 8 off on on on off off off on</p>	66MHz	66MHz	1.5x	PR100
<p>ON 1 2 3 4 5 6 7 8 off on on on off off off on</p>	66MHz	66MHz	2x	PR133
<p>ON 1 2 3 4 5 6 7 8 off on on on off on off on</p>	66MHz	66MHz	2.5x	PR166 / K6-166
<p>ON 1 2 3 4 5 6 7 8 off on on off off on on on</p>	66MHz	66MHz	3x	K6-200
<p>ON 1 2 3 4 5 6 7 8 off on on off off off off on</p>	66MHz	66MHz	3.5x	K6-233
<p>ON 1 2 3 4 5 6 7 8 off on on on off on on on</p>	66MHz	66MHz	4x	K6-266 K6-2/266
<p>ON 1 2 3 4 5 6 7 8 off on on on on on on on</p>	66MHz	66MHz	4.5x	K6-300
<p>ON 1 2 3 4 5 6 7 8 off off off on off on off off</p>	100MHz	66MHz	3x	K6-2/300
<p>ON 1 2 3 4 5 6 7 8 on off off on off off off off</p>	95MHz	63MHz	3.5x	K6-2/333
<p>ON 1 2 3 4 5 6 7 8 off off off on off off off off</p>	100MHz	66MHz	3.5x	K6-2/350

	100MHz	66MHz	4x	K6-2/400
--	--------	-------	----	----------

4.2 JP1: DRAM Operating Frequency

JP1		SDRAM Frequency
pin 1-2	short	Run CPU Clock
pin 2-3	short	Run AGP Clock

*NOTE: Set the SDRAM Frequency to **Run CPU Clock** only when the CPU clock is 100MHz and the DIMM module onboard meets PC-100 specifications.*

4.3 SW2(1-4): CPU Voltage Selector

For Single Voltage CPU:
Intel P54C, Cyrix 6x86, AMD K5, IDT WinChip C6



SW2	V _{IO}	V _{CORE}
	3.5V	3.5V

For Dual Voltage CPU:
Intel P55C, Cyrix 6x86L/MX/MII, AMD K6/K6-2, IDT WinChip 2-3D

SW2	V _{IO}	V _{CORE}	CPU
	3.3V	3.5V	WinChip 2-3D (0.35μ)
	3.3V	3.4V	
	3.3V	3.3V	

Remarks: 0.35μ and 0.25μ refers to CPU manufacturing process.

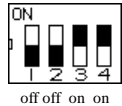
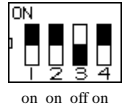
For Dual Voltage CPU:
Intel P55C, Cyrix 6x86L/MX/MII, AMD K6/K6-2, IDT WinChip 2-3D

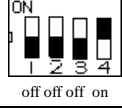
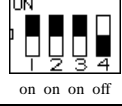
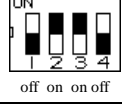
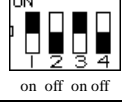
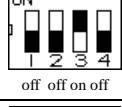
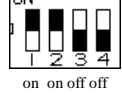

SW2	V _{IO}	V _{CORE}	CPU
 off on on on	3.3V	3.2V	K6-233 (0.35μ)
 on on off on	3.3V	3.1V	
 off on off on	3.3V	3.0V	
 on off on on	3.3V	2.9V	K6-166/200 6x86MX
 off off off on	3.3V	2.8V	WinChip 2-3D (0.35μ) P55C 6x86L
 on on on off	3.3V	2.7V	
 off on on off	3.3V	2.6V	
 on off on off	3.3V	2.5V	
 off off on off	3.3V	2.4V	
 on on off off	3.3V	2.3V	

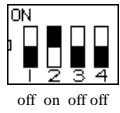
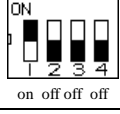
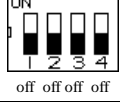
For Dual Voltage CPU:
 Intel P55C, Cyrix 6x86L/MX/MII, AMD K6/K6-2

SW2	V _{IO}	V _{CORE}	CPU
 off on off off	3.3V	2.2V	K6, K6-2 (0.25μ)
 on off off off	3.3V	2.1V	
 off off off off	3.3V	2.0V	

4.4 JP5: Clear CMOS Selection

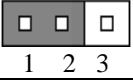
Use JP5, a 3-pin header, to clear the contents of the CMOS RAM. Do not clear the CMOS RAM unless it is absolutely necessary. You will lose your password, etc.

JP5	Function
 1 2 3	Normal
 1 2 3	Clear CMOS

NOTE: The ATX-power connector should be disconnected from the motherboard before clearing CMOS.

Chapter 5 Installation

This chapter describes the connectors and interfaces that the TI5VGS+ provides for creating a working system. Refer to Figure 3 for the location of the connectors.

The following items are covered in this chapter:

5.1 I/O Connectors	23
5.2 J1: PS/2 Keyboard and PS/2 Mouse Connectors.....	23
5.3 J2: USB Connector.....	24
5.4 J3, J5 Serial Ports.....	24
5.5 J4: Parallel Port Connector	25
5.6 J6: ATX Power Supply Connector.....	25
5.7 J7: Floppy Drive Connector	26
5.8 IDE1, IDE2: EIDE Connectors	27
5.9 J8: CPU Fan Power Connector.....	28
5.10 J9: IrDA Connector.....	28
5.11 J10 Wake on LAN Connector	28
5.12 J12: Chassis Fan Power Connector	28
5.13 J13 Front Bezel Connector.....	29

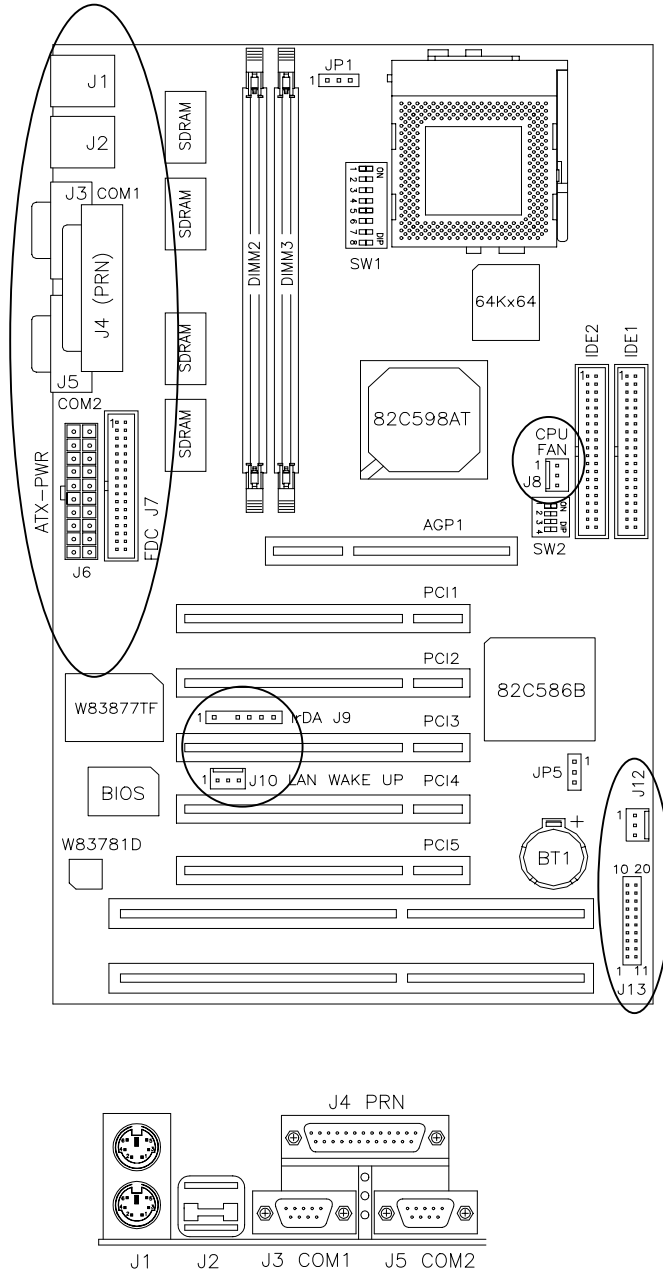

Figure 3: Connector Location on the TI5VGS+

5.1 I/O Connectors

The I/O connectors connect the TI5VGS+ to the most common peripherals. To attach cables to these connectors, carefully align Pin 1 of the cables to that of the connectors. Refer to Figure 4 for the location and orientation of the connectors.

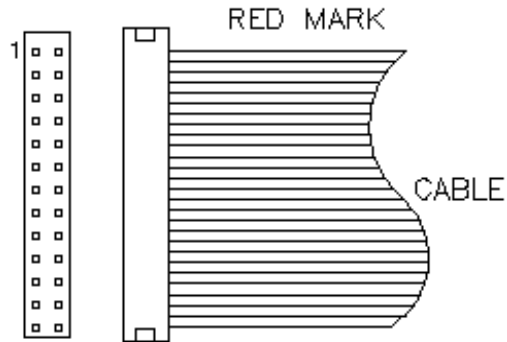
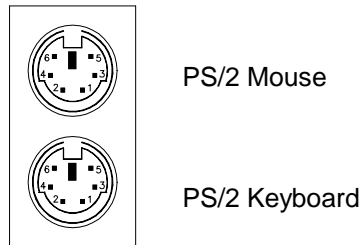

Figure 4: Orientation of the I/O Connector

5.2 J1: PS/2 Keyboard and PS/2 Mouse Connectors



Below are the pin-out assignments of the connectors.

Signal Name	Keyboard	Mouse	Signal Name
Keyboard data	1	1	Mouse data
N.C.	2	2	N.C.
Ground	3	3	Ground
5V	4	4	5V
Keyboard clock	5	5	Mouse Clock
N.C.	6	6	N.C.

5.3 J2: USB Connector

J2 is the standard USB external connector consisting of two ports. USB support allows connections of up to 64 plug and play external peripherals per channel. The following table shows the pin outs of these ports.

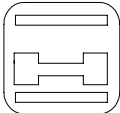
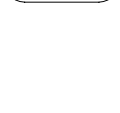
USB0  USB1 	J2 Pin #	Signal Name
	1/5	Vcc
	2/6	USB-
	3/7	USB+
	4/8	Ground

5.4 J3, J5 Serial Ports

The onboard serial ports of the TI5VGS+, J3 and J5, are two DB-9 external connectors. The following table shows the pin-out assignments of the these connectors.

Signal Name	Pin #	Pin #	Signal Name
DCD, Data carrier detect	1	6	DSR, Data set ready
RXD, Receive data	2	7	RTS, Request to send
TXD, Transmit data	3	8	CTS, Clear to send
DTR, Data terminal ready	4	9	RI, Ring indicator
GND, ground	5	10	Not Used

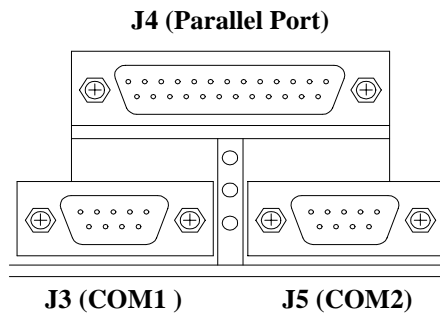

5.5 J4: Parallel Port Connector

J4 is a DB-25 external connector. The following table describes the pin-out assignments of this connector. See the figure on the previous page.

Signal Name	Pin #	Pin #	Signal Name
Line printer strobe	1	14	AutoFeed
PD0, parallel data 0	2	15	Error
PD1, parallel data 1	3	16	Initialize
PD2, parallel data 2	4	17	Select
PD3, parallel data 3	5	18	Ground
PD4, parallel data 4	6	19	Ground
PD5, parallel data 5	7	20	Ground
PD6, parallel data 6	8	21	Ground
PD7, parallel data 7	9	22	Ground
ACK, acknowledge	10	23	Ground
Busy	11	24	Ground
Paper empty	12	25	Ground
Select	13	N/A	N/A

5.6 J6: ATX Power Supply Connector

J6 is a 20-pin ATX power supply connector. Refer to the following table for the pin out assignments.

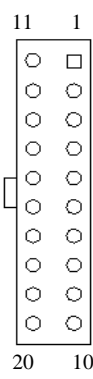

Signal Name	Pin #	Pin #	Signal Name
3.3V	11	1	3.3V
-12V	12	2	3.3V
Ground	13	3	Ground
PS-ON	14	4	+5V
Ground	15	5	Ground
Ground	16	6	+5V
Ground	17	7	Ground
-5V	18	8	Power good
+5V	19	9	5VSB
+5V	20	10	+12V

5.7 J7: Floppy Drive Connector

J7 of the TI5VGS+ is a 34-pin header and will support up to 2.88MB floppy drives.

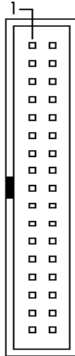

Signal Name	Pin #	Pin #	Signal Name
Ground	1	2	RM/LC
Ground	3	4	No connect
Ground	5	6	No connect
Ground	7	8	Index
Ground	9	10	Motor enable 0
Ground	11	12	Drive select 1
Ground	13	14	Drive select 0
Ground	15	16	Motor enable 1
Ground	17	18	Direction
Ground	19	20	Step
Ground	21	22	Write data
Ground	23	24	Write gate
Ground	25	26	Track 00
Ground	27	28	Write protect
Ground	29	30	Read data
Ground	31	32	Side 1 select
Ground	33	34	Diskette change

5.8 IDE1, IDE2: EIDE Connectors

IDE1: Primary IDE Connector

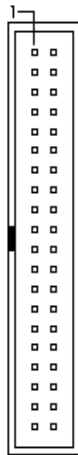

Signal Name	Pin #	Pin #	Signal Name
Reset IDE	1	2	Ground
Host data 7	3	4	Host data 8
Host data 6	5	6	Host data 9
Host data 5	7	8	Host data 10
Host data 4	9	10	Host data 11
Host data 3	11	12	Host data 12
Host data 2	13	14	Host data 13
Host data 1	15	16	Host data 14
Host data 0	17	18	Host data 15
Ground	19	20	Key
DRQ0	21	22	Ground
Host IOW	23	24	Ground
Host IOR	25	26	Ground
IOCHRDY	27	28	Host ALE
DACK0	29	30	Ground
IRQ14	31	32	No connect
Address 1	33	34	No connect
Address 0	35	36	Address 2
Chip select 0	37	38	Chip select 1
Activity	39	40	Ground

IDE2: Secondary IDE Connector

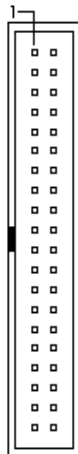

Signal Name	Pin #	Pin #	Signal Name
Reset IDE	1	2	Ground
Host data 7	3	4	Host data 8
Host data 6	5	6	Host data 9
Host data 5	7	8	Host data 10
Host data 4	9	10	Host data 11
Host data 3	11	12	Host data 12
Host data 2	13	14	Host data 13
Host data 1	15	16	Host data 14
Host data 0	17	18	Host data 15
Ground	19	20	Key
DRQ0	21	22	Ground
Host IOW	23	24	Ground
Host IOR	25	26	Ground
IOCHRDY	27	28	Host ALE
DACK1	29	30	Ground
MIRQ0	31	32	No connect
Address 1	33	34	No connect
Address 0	35	36	Address 2
Chip select 0	37	38	Chip select 1
Activity	39	40	Ground

5.9 J8: CPU Fan Power Connector

J8 is a 3-pin header for the CPU fan power connector. The fan must be a 12V fan.

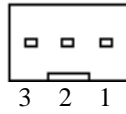

Pin #	Signal Name
1	Fan sensor
2	+12V
3	Ground

5.10 J9: IrDA Connector

This connector is used for an IrDA connector that supports infrared wireless communication with IrDA devices.

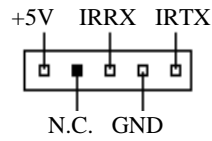

Pin #	Signal Name
1	+5V
2	No connect
3	Ir RX
4	Ground
5	Ir TX

5.11 J10 Wake on LAN Connector

J10 is a 3-pin header for Wake on LAN function on the motherboard.

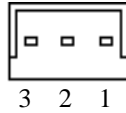

Pin #	Signal Name
1	5VSB
2	Ground
3	Wake on LAN

5.12 J12: Chassis Fan Power Connector

J12 is a 3-pin header for the chassis fan power connector. The fan must be a 12V fan.

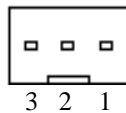

Pin #	Signal Name
1	Fan sensor
2	+12V
3	Ground

5.13 J13 Front Bezel Connector

The front bezel of the case has a control panel which provides light indication of the computer activities and switches to change the computer status. J13 is a 20-pin header that provides interfaces for the following functions.

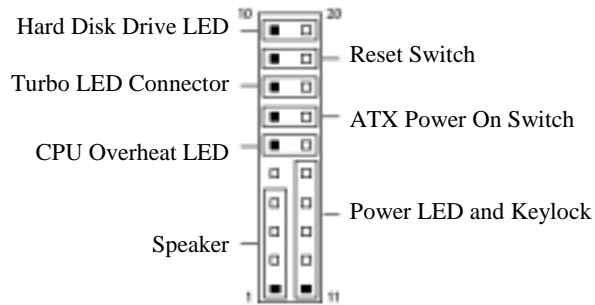

Speaker: Pins 1 - 4

This connector provides an interface to a speaker for audio tone generation. An 8-ohm speaker is recommended.



J13 Pin #	Signal Name
1	Speaker out
2	No connect
3	Ground
4	+5V

Power LED and Keylock: Pins 11 - 15

The power LED indicates the status of the main power switch. The keylock switch, when closed, will disable the keyboard function.



J13 Pin #	Signal Name
11	Power LED
12	No connect
13	Ground
14	Keylock
15	Ground

CPU Overheat LED: Pins 6 and 16

This connector connects to the CPU Overheat LED that lights up when CPU temperature exceeds the CPU warning temperature set in the BIOS. When this occurs, the system slows down until the temperature falls to a safe level.

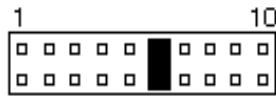

J13 Pin #	Signal Name
6	5V
16	Ground

ATX Power ON Switch: Pins 7 and 17

This is an “ATX Power Supply On/Off Switch” that is connected to the power switch on the case. When pressed for more than 4 seconds, the system powers off. When pressed for less than 4 seconds, the system enters the Suspend Mode (depending on BIOS pre-settings).

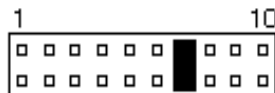

Turbo LED Connector: Pins 8 and 18

There is no turbo/deturbo function on the motherboard. The Turbo LED will always be On when linked to this connector.

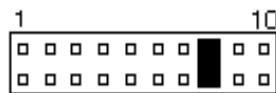

J13 Pin #	Signal Name
8	5V
18	Ground

Reset Switch: Pins 9 and 19

The reset switch allows the user to reset the system without turning the main power off and then on again. Orientation is not required when making a connection to this header.

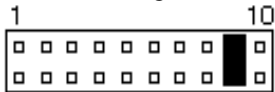

Hard Disk Drive LED Connector: Pins 10 and 20

This connector connects to the hard drive activity LED on the control panel. The LED flashes when HDD is in use.

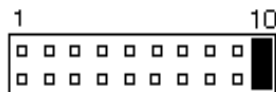

J13 Pin #	Signal Name
10	Ground
20	5V

Chapter 7 BIOS Configuration

This chapter describes the different settings available in the Award BIOS that comes with the T15VGS+ motherboard. The topics covered in this chapter are as follows:

- 6.1 BIOS Introduction34
- 6.2 BIOS Setup34
- 6.3 Standard CMOS Setup36
 - Date
 - Time
 - Primary HDDs / Secondary HDDs
 - Drive A / Drive B
 - Floppy 3 Mode Support
 - Video
 - Halt On
- 6.4 BIOS Features Setup39
 - Virus Warning
 - CPU Internal Cache / External Cache
 - Quick Power On Self Test
 - Boot Sequence
 - Swap Floppy Drive
 - Boot Up Floppy Seek
 - Boot Up NumLock Status
 - Boot Up System Speed
 - Gate A20 Option
 - Memory Parity/ECC Check
 - Typematic Rate Setting
 - Typematic Rate (Chars/Sec)
 - Typematic Delay (Msec)
 - Security Option
 - PCI/VGA Palette Snoop
 - OS Select for DRAM > 64MB
 - Video BIOS Shadow
 - C8000 - CBFFF Shadow/DC000 - DFFFF Shadow
- 6.5 Chipset Features Setup42
 - Bank DRAM Timing
 - SDRAM Cycle Length

- DRAM Read Pipeline
- Sustained 3T Write
- Cache Rd+CPU Wt Pipeline
- Cache Timing
- Video BIOS Cacheable
- System BIOS Cacheable
- Memory Hole at 15MB Addr.
- AGP Aperture Size
- Cyrix M2 ADS# delay
- OnChip USB
- CPU Warning Temperature
- Temperature/Fan Speed/Voltage
- 6.6 Power Management Setup44
 - Power Management
 - PM Control by APM
 - Video Off Method
 - Modem Use IRQ
 - Soft-Off by PWRBTN
 - HDD Power Down
 - Doze Mode
 - Suspend Mode
 - PM Events
- 6.7 PNP/PCI Configuration47
 - PNP OS Installed
 - Resources Controlled by
 - Reset Configuration Data
 - ACPI I/O Device Node
 - IRQ3/4/5/7/9/10/11/12/14/15, DMA0/1/3/5/6/7 assigned to
 - CPU to PCI Write Buffer
 - PCI Dynamic Bursting
 - PCI Master 0 WS Write
 - PCI Delay Transactiona
 - PCI Master Read Prefetch
 - PCI#2 Access #1 Retry
 - AGP Master 1 WS Write
 - AGP Master 1 WS Read
 - PCI IRQ Activated by
 - Assign IRQ for USB/VGA

6.8 Load BIOS Defaults	50
6.9 Load Setup Defaults	50
6.10 Integrated Peripherals	51
OnChip Primary/Secondary PCI IDE	
IDE Prefetch Mode	
IDE HDD Block Mode	
IDE Primary/Secondary Master/Slave PIO	
IDE Primary/Secondary Master/Slave UDMA	
Onboard FDD Controller	
Onboard Serial/Parallel Port	
UART 2 Mode	
Onboard Parallel Mode	
6.11 Supervisor / User Password.....	53
6.12 IDE HDD Auto Detection	54
6.13 HDD Low Level Format.....	54
6.14 Save & Exit Setup.....	55
6.15 Exit Without Saving	55

6.1 BIOS Introduction

The Award BIOS (Basic Input/Output System) installed in your computer system's ROM supports Intel/Cyrix/AMD processors in a standard IBM-AT compatible I/O system. The BIOS provides critical low-level support for a standard device such as disk drives, serial and parallel ports. It also adds virus and password protection as well as special support for detailed fine-tuning of the chipset controlling the entire system.

6.2 BIOS Setup

The Award BIOS provides a Setup utility program for specifying the system configurations and settings. The BIOS ROM of the system stores the Setup utility. When you turn on the computer, the Award BIOS is immediately activated. Pressing the key immediately allows you to enter the Setup utility. If you are a little bit late pressing the key, POST(Power On Self Test) will continue with its test routines, thus preventing you from invoking the Setup. If you still wish to enter Setup, restart the system by pressing the "Reset" button or simultaneously pressing the <Ctrl>, <Alt> and <Delete> keys. You can also restart by turning the system Off and back On again. The following message will appear on the screen:

Press to Enter Setup

In general, you press the arrow keys to highlight items, <Enter> to select, the <PgUp> and <PgDn> keys to change entries, <F1> for help and <Esc> to quit.

When you enter the Setup utility, the Main Menu screen will appear on the screen. The Main Menu allows you to select from various setup functions and exit choices.

ROM PCI/ISA BIOS
CMOS SETUP UTILITY
AWARD SOFTWARE, INC.

STANDARD CMOS SETUP	INTEGRATED PERIPHERALS
BIOS FEATURES SETUP	SUPERVISOR PASSWORD
CHIPSET FEATURES SETUP	USER PASSWORD
POWER MANAGEMENT SETUP	IDE HDD AUTO DETECTION
PNP/PCI CONFIGURATION	HDD LOW LEVEL FORMAT
LOAD BIOS DEFAULTS	SAVE & EXIT SETUP
LOAD SETUP DEFAULTS	EXIT WITHOUT SAVING
ESC : Quit	↑ ↓ → ← : Select Item
F10 : Save & Exit Setup	(Shift) F2 : Change Color
Time, Date, Hard Disk Type	

The section below the setup items of the Main Menu displays the control keys for this menu. At the bottom of the Main Menu just below the control keys section displays information on the currently highlighted item in the list.

NOTE: If your computer cannot boot after making and saving system changes with Setup, the Award BIOS supports an override to the CMOS settings that resets your system to its default.

We strongly recommend that you avoid making any changes to the chipset defaults. These defaults have been carefully chosen by both Award and your system manufacturer to provide the absolute maximum performance and reliability.

6.3 Standard CMOS Setup

The “Standard CMOS Setup” choice allows you to record some basic hardware configurations in your computer system and set the system clock and error handling. If the motherboard is already installed in a working system, you will not need to select this option. You will need to run the Standard CMOS option, however, if you change your system hardware configurations, the onboard battery fails, or the configuration stored in the CMOS memory was lost or damaged.

ROM PCI/ISA BIOS STANDARD CMOS SETUP AWARD SOFTWARE, INC.								
Date (mm:dd:yy) : Mon , Aug 19 1996								
Time (hh:mm:ss) : 00 : 00 : 00								
HARD DISKS	TYPE	SIZE	CYLS	HEAD	PRECOMP	LANDZ	SECTOR	MODE
Primary Master	Auto	0	0	0	0	0	0	Auto
Primary Slave	None	0	0	0	0	0	0	-----
Secondary Master	None	0	0	0	0	0	0	-----
Secondary Slave	None	0	0	0	0	0	0	-----
Drive A	: 1.44M, 3.5in							
Drive B	: None							
Floppy 3 Mode Support	: Disabled							
Video	: EGA / VGA							
Halt On	: All Errors							
			Base Memory			: 640K		
			Extended Memory			: 15360K		
			Other Memory			: 384K		
			Total Memory			: 16384K		
ESC : Quit			↑ ↓ → ← : Select			Item PU / PD / + / - : Modify		
F1 : Help			(Shift) F2 : Change Color					

At the bottom of the menu are the control keys for use on this menu. If you need any help in each item field, you can press the <F1> key. It will display the relevant information to help you. The memory display at the lower right-hand side of the menu is read-only. It will adjust automatically according to the memory changed. The following describes each item of this menu.

Date

The date format is:

Day : Sun to Sat
Month : 1 to 12
Date : 1 to 31
Year : 1994 to 2079

To set the date, highlight the “Date” field and use the PageUp/PageDown or +/- keys to set the current time.

Time

The time format is: **Hour : 00 to 23**
Minute : 00 to 59
Second : 00 to 59

To set the time, highlight the "Time" field and use the <PgUp>/<PgDn> or +/- keys to set the current time.

Primary HDDs / Secondary HDDs

The onboard PCI IDE connectors provide Primary and Secondary channels for connecting up to four IDE hard disks or other IDE devices. Each channel can support up to two hard disks; the first is the "Master" and the second is the "Slave".

To enter the specifications for a hard disk drive, you must select first a "Type". There are 45 predefined types and 4 user definable types are for Enhanced IDE BIOS. Type 1 to 45 are predefined. Type "User" is user-definable. For the Primary Master/Slave as well as Secondary Master/Slave, you can select "Auto" under the TYPE and MODE fields. This will enable auto detection of your IDE drives and CD-ROM drive during POST.

Press <PgUp>/<PgDn> to select a numbered hard disk type or type the number and press the <Enter> key. The hard disk will not work properly if you enter incorrect information for this field. If your hard disk drive type is not matched or listed, you can use Type User to define your own drive type manually. If you select Type User, you will be asked to enter the following information.

CYLS : Number of cylinders
HEAD : Number of read/write heads
PRECOMP : Write precompensation
LANDZ : Landing zone
SECTOR : Number of sectors
SIZE : Automatically adjust according to the configuration
MODE (for IDE HDD only) : Auto
Normal (HD < 528MB)
Large (for MS-DOS only)
LBA (HD > 528MB and supports
Logical Block Addressing)

NOTE: The specifications of your drive must match with the drive table. The hard disk will not work properly if you enter incorrect information in these fields. If your hard disk drive type is not matched or listed, you can use Type User to define your own drive type manually.

Drive A / Drive B

These fields identify the types of floppy disk drive A or drive B that has been installed in the computer. The available specifications are:

360KB 1.2MB 720KB 1.44MB 2.88MB
5.25 in. 5.25 in. 3.5 in. 3.5 in. 3.5 in.

Floppy 3 Mode Support

This is the Japanese standard floppy drive. The standard stores 1.2MB in a 3.5-inch diskette. You have four options to choose:

Disabled	No 3 mode floppy drive installed. (default)
Drive A	Installed 3 mode drive at drive A.
Drive B	Installed 3 mode drive at drive B.
Both	Installed 3 mode drive at drive A and B.

Video

This field selects the type of video display card installed in your system. You can choose the following video display cards:

EGA/VGA	For EGA, VGA, SEGA, SVGA or PGA monitor adapters. (default)
CGA 40	Power up in 40 column mode.
CGA 80	Power up in 80 column mode.
MONO	For Hercules or MDA adapters.

Halt On

This field determines whether the system will halt if an error is detected during power up.

No errors	Whenever the BIOS detects a non-fatal error, the system will stop and you will be prompted.
All errors	The system boot will not be halted for any error that may be detected. (default)
All, But Keyboard	The system boot will not be halted for a keyboard error; it will stop for all other errors.
All, But Diskette	The system boot will not be halted for a disk error; it will stop for all other errors.
All, But Disk/Key	The system boot will not be halted for a keyboard or disk error; it will stop for all others.

6.4 BIOS Features Setup

This section allows you to configure and improve your system and allows you to set up some system features according to your preference.

ROM / PCI ISA BIOS BIOS FEATURES SETUP AWARD SOFTWARE, INC.			
Virus Warning	: Disabled	Video BIOS Shadow	: Enabled
CPU Internal Cache	: Enabled	C8000-CBFFF Shadow	: Disabled
External Cache	: Enabled	CC000-CFFFF Shadow	: Disabled
Quick Power On Self Test	: Enabled	D0000-D3FFF Shadow	: Disabled
Boot Sequence	: A, C, SCSI	D4000-D7FFF Shadow	: Disabled
Swap Floppy Drive	: Disabled	D8000-DBFFF Shadow	: Disabled
Boot Up Floppy Drive	: Enabled	DC000-DFFF Shadow	: Disabled
Boot Up Numlock Status	: On		
Boot Up System Speed	: High		
Gate A20 Option	: Fast		
Memory Parity/ECC Check	: Disabled		
Typematic Rate Setting	: Disabled		
Typematic Rate (chars/Sec)	: 6		
Typematic Delay (Msec)	: 250		
Security Option	: Setup		
PCI /VGA Palette Snoop	: Disabled		
OS Select For DRAM>64MB	: Non-OS2	ESC : Quit	↑ ↓ → ← : Select Item
HDD S.M.A.R.T. capability	: Disabled	F1 : Help	PU/PD/+/- : Modify
		F5 : Old Values	(Shift) F2 : Color
		F6 : Load BIOS Defaults	
		F7 : Load Setup Defaults	

Virus Warning

This item protects the boot sector and partition table of your hard disk against accidental modifications. If an attempt is made, the BIOS will halt the system and display a warning message. If this occurs, you can either allow the operation to continue or run an anti-virus program to locate and remove the problem.

NOTE: Many disk diagnostic programs, which attempt to access the boot sector table, can cause the virus warning. If you will run such a program, disable the Virus Warning feature.

CPU Internal Cache / External Cache

These items allow you to enable (speed up memory access) or disable the cache function. By default, these items are **Enabled**.

Quick Power On Self Test

This choice speeds up the Power On Self Test (POST) after you power up the system. If it is set to **Enabled**, BIOS will skip some items. By default, this choice is **Enabled**.

Boot Sequence

This field determines the drive that the system searches first for an operating system. The options are :

A, C, SCSI	D, A, SCSI	SCSI, C, A
C, A, SCSI	E, A, SCSI	C only
C, CDROM, A	F, A, SCSI	LS/ZIP, C
CDROM, C, A	SCSI, A, C	

The default value is **A, C, SCSI**.

Swap Floppy Drive

This item allows you to determine whether to enable Swap Floppy Drive or not. When enabled, the BIOS swaps floppy drive assignments so that Drive A becomes Drive B, and Drive B becomes Drive A. By default, this field is set to **Disabled**.

Boot Up Floppy Seek

When enabled, the BIOS will seek whether or not the floppy drive installed has 40 or 80 tracks. 360K type has 40 tracks while 760K, 1.2M and 1.44M all have 80 tracks. By default, this field is set to **Enabled**.

Boot Up NumLock Status

This allows you to activate the NumLock function after you power up the system. By default, the system boots up with **NumLock On**.

Boot Up System Speed

This has no function and selects the default system speed (**High**).

Gate A20 Option

This field allows you to select how Gate A20 is worked. The Gate A20 is a device used to address memory above 1 MB. By default, this field is set to **Fast**.

Memory Parity/ECC Check

Set this option to Enabled, when the memory installed in your system supports ECC (error correction code) or parity. By default, this field is set to **Disabled**.

Typematic Rate Setting

When disabled, continually holding down a key on your keyboard will generate only one instance. When enabled, you can set the two typematic controls listed next. By default, this field is set to **Disabled**.

Typematic Rate (Chars/Sec)

When the typematic rate is enabled, the system registers repeated keystrokes speeds. You can select speed range from 6 to 30 characters per second. By default, this item is set to **6**.

Typematic Delay (Msec)

When the typematic rate is enabled, this item allows you to set the time interval for displaying the first and second characters. By default, this item is set to **250msec**.

Security Option

This field allows you to limit access to the System and Setup. The default value is **Setup**. When you select **System**, the system prompts for the User Password every time you boot up. When you select **Setup**, the system always boots up and prompts for the Supervisor Password only when the Setup utility is called up.

PCI/VGA Palette Snoop

Some non-standard VGA display cards may not show colors properly. This field allows you to set whether MPEG ISA/VESA VGA Cards can work with PCI/VGA or not. When this field is enabled, a PCI/VGA can work with an MPEG ISA/VESA VGA card. When this field is disabled, a PCI/VGA cannot work with an MPEG ISA/VESA Card.

OS Select for DRAM > 64MB

This option allows the system to access greater than 64MB of DRAM memory when used with OS/2 that depends on certain BIOS calls to access memory. The default setting is **NON-OS/2**.

HDD S.M.A.R.T. capability

This item enables or disables the SMART capability of hard disks. By default, this field is set to **Disabled**.

Video BIOS Shadow

This item allows you to change the Video BIOS location from ROM to RAM. Video Shadow will increase the video speed.

C8000 - CBFFF Shadow/DC000 - DFFFF Shadow

Shadowing a ROM reduces the memory available between 640KB to 1024KB. These fields determine whether optional ROM will be copied to RAM or not.

6.5 Chipset Features Setup

This Setup menu controls the configuration of the motherboard chipset.

ROM PCI/ISA BIOS CHIPSET FEATURES SETUP AWARD SOFTWARE INC.			
Bank 0/1 DRAM Timing	: SDRAM 8ns	OnChip USB	: Enabled
Bank 2/3 DRAM Timing	: SDRAM 8ns	USB Keyboard Support	: Enabled
Bank 4/5 DRAM Timing	: SDRAM 8ns	CPU Warning Temperature	: 70°C/158°F
SDRAM Cycle Length	: 3	Current System Temp	:
DRAM Read Pipeline	: Enabled	Current CPU Temperature	:
Cache Rd+CPU Wt Pipeline	: Enabled	CPU FAN Speed	:
Cache Timing	: Fast	CHASSIS FAN Speed	:
Video BIOS Cacheable	: Enabled	VCORE	: VIO
System BIOS Cacheable	: Disabled	VCC3	:
Memory Hole At 15MB	: Disabled	+12 V	: +5 V
Aperture Size	: 64M	- 5V	: -12 V
Cyrix M2 ADS# delay	: Disabled	Shutdown Temperature	: 75°C/167°F
		ESC : Quit	↑ ↓ → ← : Select Item
		F1 : Help	PU/PD/+/- : Modify
		F5 : Old Values	(Shift) F2 : Color
		F6 : Load BIOS Defaults	
		F7 : Load Setup Defaults	

Bank DRAM Timing

These fields defines the speed of the DRAM memory onboard. By default, these fields are set to *SDRAM 8ns*.

SDRAM Cycle Length

This field sets the SDRAM cycle length to either 2 or 3. The default setting is 3.

DRAM Read Pipeline

When enabled, this field supports pipelining of DRAM reads The default setting is *Enabled*.

Cache Rd+CPU Wt Pipeline

When enabled, this item allows pipelining of cache reads and CPU writes. The default setting is *Enabled*.

Cache Timing

This field sets the timing of the cache in the system. The options are *Fast* and *Fastest*. By default, this field is set to *Fast*.

Video BIOS Cacheable

When enabled, access to video BIOS addressed at C0000H to C7FFFH are cached, provided that the cache controller is enabled.

System BIOS Cacheable

When enabled, access to the system BIOS ROM addressed at F0000H-FFFFFH are cached, provided that the cache controller is enabled.

Memory Hole at 15MB Addr.

In order to improve performance, certain space in memory can be reserved for ISA cards. This field allows you to reserve 15MB to 16MB of memory address space to ISA expansion cards. This makes memory from 15MB and up unavailable to the system. Expansion cards can only access memory up to 16MB. By default, this field is set to *Disabled*.

AGP Aperture Size

The field sets aperture size of the graphics. The aperture is a portion of the PCI memory address range dedicated for graphics memory address space. Host cycles that hit the aperture range are forwarded to the AGP without any translation. The default setting is *64M*.

Cyrix M2 ADS# delay

This field is only visible when your system supports a Cyrix M2 processor. It enables or disables the ADS# delay signal for Cyrix M2.

OnChip USB

This field allows you either to enable or disable the USB function. By default, this field is set to *Enabled*.

USB Keyboard Support

Enable this field if your system supports a USB keyboard.

CPU Warning Temperature

When the CPU reaches the CPU Warning Temperature, the system alarms the user through the speaker.

Temperature/Fan Speed/Voltage

The values for the system/CPU temperature, CPU/chassis fan speed and system voltages are displayed as monitored by the H/W monitoring IC.

Shutdown Temperature

To avoid hardware damage due to overheat, this field can be configured so that the system shuts down automatically when it reaches the set temperature.

6.6 Power Management Setup

The Power Management Setup allows you to save energy of your system effectively. It will shut down the hard disk and turn off video display after a period of inactivity.

ROM PCI/ISA BIOS (2A59IM29)
POWER MANAGEMENT SETUP
AWARD SOFTWARE, INC.

ACPI Function	: Enabled	Primary INTR	: ON
Power Management	: User Define	IRQ3 (COM2)	: Primary
PM Control by APM	: Yes	IRQ4 (COM1)	: Primary
Video Off Option	: Suspend -> Off	IRQ5 (LPT 2)	: Primary
Video Off Method	: V/H SYNC +Blank	IRQ6 (Floppy Disk)	: Primary
MODEM Use IRQ	: 3	IRQ7 (LPT 1)	: Primary
Soft-Off by PWRBTN	: Instant-Off	IRQ8 (RTC Alarm)	: Disabled
** PM Timers **		IRQ9 (IRQ2 Redir)	: Secondary
HDD Power Down	: Disabled	IRQ10 (Reserved)	: Secondary
Doze Mode	: Disabled	IRQ11 (Reserved)	: Secondary
Suspend Mode	: Disabled	IRQ12 (PS/2 Mouse)	: Primary
** PM Events **		IRQ13 (Coprocessor)	: Primary
VGA	: OFF	IRQ14 (Hard Disk)	: Primary
LPT & COM	: LPT / COM	IRQ15 (Reserved)	: Disabled
HDD & FDD	: ON	ESC : Quit ↑ ↓ → ← : Select Item	
DMA / master	: OFF	F1 : Help PU/PD/+/- : Modify	
Modem Ring Resume	: Disabled	F5 : Old Values (Shift) F2 : Color	
RTC Alarm Resume	: Disabled	F6 : Load BIOS Defaults	
		F7 : Load Setup Defaults	

ACPI Function

This field enables or disables the ACPI function on the motherboard. ACPI stands for Advanced Configuration Power Interface.

Power Management

This field allows you to select the type of power saving management modes. There are four selections for Power Management.

Disabled	No power management.
Min. Power Saving	Minimum power management.
Max. Power Saving	Maximum power management. Only available for SL CPU.
User Define	Each of the ranges are from 1 min. to 1hr. Except for HDD Power Down which ranges from 1 min. to 15 min. (Default)

NOTE: In order to enable the CPU overheat protection feature, the Power Management field should not be set to Disabled.

PM Control by APM

This field allows you to use the Advanced Power Management device to enhance the Max. Power Saving mode and stop the CPU's internal clock. If the Max. Power Saving is not enabled, this will be preset to NO.

Video Off Method

This field defines the Video Off features. There are three options.

- | | |
|------------------|------------------------------------------------------------------------------------|
| V/H SYNC + Blank | Default setting, blank the screen and turn off vertical and horizontal scanning. |
| DPMS | Allows the BIOS to control the video display card if it supports the DPMS feature. |
| Blank Screen | This option only writes blanks to the video buffer. |

Modem Use IRQ

This field defines the IRQ being used by the modem. By default, the IRQ is set to 3.

Soft-Off by PWRBTN

This field defines the power-off mode when using an ATX power supply. The *Instant Off* mode allows powering off immediately upon pressing the power button. In the *Delay 4 Sec* mode, the system powers off when the power button is pressed for more than four seconds or enters the suspend mode when pressed for less than 4 seconds. The default value is *Instant Off*.

HDD Power Down

When enabled, and after the set time of system inactivity, the hard disk drive will be powered down while all other devices remain active.

Doze Mode

When enabled, and after the set time of system inactivity, the CPU clock will run at a slower speed while all other devices still operate at full speed.

Suspend Mode

When enabled, and after the set time of system inactivity, all devices except the CPU will be shut off.

PM Events

The VGA, LPT & COM, HDD & FDD, DMA /master, Modem Ring Resume, RTC Alarm Resume and Primary INTR section are I/O events which can prevent the system from entering a power saving mode or can awaken the system from such a mode. When an I/O device wants to gain the attention of the operating system, it signals this by causing an IRQ to occur. When the operating system is ready to respond to the request, it interrupts itself and performs the service. The default value is *Off*. When set On, activity will neither prevent the system from going into a power management mode nor awaken it. The IRQ section sets the wake-up call of the system. If activity is detected from any enabled IRQ channels in the left-hand group, the system wakes up from suspended mode.

6.7 PNP/PCI Configuration

This option configures the PCI bus system. All PCI bus systems on the system use INT#, thus all installed PCI cards must be set to this value.

ROM PCI/ISA BIOS PNP/PCI Configuration AWARD SOFTWARE INC.			
PNP OS Installed	: No	CPU to PCI Write Buffer	: Enabled
Resources Controlled by	: Manual	PCI Dynamic Bursting	: Enabled
Reset Configuration Data	: Disabled	PCI Master 0 WS Write	: Enabled
ACPI I/O Device Node	: Enabled	PCI Delay Transaction	: Enabled
IRQ-3 assigned to	: Legacy ISA	PCI Master Read Prefetch	: Enabled
IRQ-4 assigned to	: Legacy ISA	PCI#2 Access #1 Retry	: Disabled
IRQ-5 assigned to	: PCI/ISA PnP	AGP Master 1 WS Write	: Enabled
IRQ-7 assigned to	: Legacy ISA	AGP Master 1 WS Read	: Disabled
IRQ-9 assigned to	: PCI/ISA PnP		
IRQ-10 assigned to	: PCI/ISA PnP	PCI IRQ Activated By	: Level
IRQ-11 assigned to	: PCI/ISA PnP	Assign IRQ For USB	: Enabled
IRQ-12 assigned to	: PCI/ISA PnP	Assign IRQ For VGA	: Enabled
IRQ-14 assigned to	: Legacy ISA	Assign IRQ For ACPI	: IRQ10
IRQ-15 assigned to	: Legacy ISA		
DMA-0 assigned to	: PCI/ISA PnP		
DMA-1 assigned to	: PCI/ISA PnP	ESC : Quit	↑ ↓ ← : Select Item
DMA-3 assigned to	: PCI/ISA PnP	F1 : Help	PU/PD/+/- : Modify
DMA-5 assigned to	: PCI/ISA PnP	F5 : Old Values	(Shift) F2 : Color
DMA-6 assigned to	: PCI/ISA PnP	F6 : Load BIOS Defaults	
DMA-7 assigned to	: PCI/ISA PnP	F7 : Load Setup Defaults	

PNP OS Installed

This field allows you to specify if the operating system installed in your system is plug and play aware.

NOTE: Operating systems such as DOS, OS/2, and Windows 3.x do not use PnP.

Resources Controlled by

This PnP BIOS can configure all of the boot and compatible devices automatically. However, this capability needs you to use a PnP operating system such as Windows 95. The default value is *Manual*.

Reset Configuration Data

This field allows you to determine whether or not to reset the configuration data. The default value is *Disabled*.

ACPI I/O Device Node

This field enables or disables the ACPI I/O Device Node. The default setting is *Enabled*.

IRQ3/4/5/7/9/10/11/12/14/15, DMA0/1/3/5/6/7 assigned to

These fields allow you to determine the IRQ/DMA assigned to the ISA bus and is not available to any PCI slot.

CPU to PCI Write Buffer

When enabled, this option increases the efficiency of the PCI bus to and speed up the execution in the processor. By default, this field is set to *Enabled*.

PCI Dynamic Bursting

When enabled, this option combines several PCI cycles into one. By default, this field is set to *Enabled*.

PCI Master 0 WS Write

When enabled, this option increases the write cycle speed. By default, this field is set to *Enabled*.

PCI Delay Transaction

When enabled, this option delays PCI data transaction. By default, this field is set to *Enabled*.

PCI Master Read Prefetch

When this item is enabled, the system is allowed to prefetch the next read and initiate the next process. By default, this field is set to *Enabled*.

PCI#2 Access #1 Retry

This item enables PC#2 Access #1 attempts. By default, this field is set to *Disabled*.

AGP Master 1 WS Write

When enabled, writes to the AGP bus are executed with 1 wait states. By default, this field is set to *Enabled*.

AGP Master 1 WS Read

When enabled, reads to the AGP bus are executed with 1 wait states. By default, this field is set to *Disabled*.

PCI IRQ Activated by

This field allows you to select the method by which the PCI bus recognizes that an IRQ service is being requested by a device. The default value is *Level*.

Assign IRQ for USB/VGA

These fields allow you to enable or disable the IRQ for USB and VGA. The default setting for both is *Enabled*.

Assign IRQ for ACPI

This field assigns an IRQ for ACPI (Advanced Configuration Power Interface). The default setting is *IRQ10*.

6.8 Load BIOS Defaults

This option allows you to load the troubleshooting default values permanently stored in the BIOS ROM. These default settings are non-optimal and disable all high-performance features.

ROM PCI/ISA BIOS
CMOS SETUP UTILITY
AWARD SOFTWARE, INC.

STANDARD CMOS SETUP	INTEGRATED PERIPHERALS
BIOS FEATURES SETUP	SUPERVISOR PASSWORD
CHIPSET FEATURES SETUP	USER PASSWORD
POWER MANAGE	DETECTION
PNP/PCI CONF	FORMAT
LOAD BIOS DEF	UP
LOAD SETUP DEF	EXIT WITHOUT SAVING
ESC : Quit	↑ ↓ → ← : Select Item
F10 : Save & Exit Setup	(Shift) F2 : Change Color
Load BIOS Defaults except Standard CMOS Setup	

To load BIOS defaults value to CMOS SRAM, enter “Y”. If not, enter “N”.

6.9 Load Setup Defaults

This option allows you to load the default values to your system configuration. These default settings are optimal and enable all high performance features.

ROM PCI/ISA BIOS
CMOS SETUP UTILITY
AWARD SOFTWARE, INC.

STANDARD CMOS SETUP	INTEGRATED PERIPHERALS
BIOS FEATURES SETUP	SUPERVISOR PASSWORD
CHIPSET FEATURES SETUP	USER PASSWORD
POWER MANAGE	DETECTION
PNP/PCI CONF	FORMAT
LOAD BIOS DEF	UP
LOAD SETUP DEF	EXIT WITHOUT SAVING
ESC : Quit	↑ ↓ → ← : Select Item
F10 : Save & Exit Setup	(Shift) F2 : Change Color
Load BIOS Defaults except Standard CMOS Setup	

To load SETUP defaults value to CMOS SRAM, enter “Y”. If not, enter “N”.

6.10 Integrated Peripherals

This option sets your hard disk configuration, mode and port.

ROM PCI/ISA BIOS INTEGRATED PERIPHERALS AWARD SOFTWARE INC.			
OnChip IDE First Channel	: Enabled	Onboard Parallel Port	: 378H/IRQ7
OnChip IDE Second Channel	: Enabled	Onboard Parallel Mode	: SPP
IDE Prefetch Mode	: Disabled		
IDE HDD Block Mode	: Enabled		
IDE Primary Master PIO	: Auto		
IDE Primary Slave PIO	: Auto		
IDE Secondary Master PIO	: Auto		
IDE Secondary Slave PIO	: Auto		
IDE Primary Master UDMA	: Auto		
IDE Primary Slave UDMA	: Auto		
IDE Secondary Master UDMA	: Auto		
IDE Secondary Slave UDMA	: Auto		
Init Display First	: AGP		
Onboard FDD Controller	: Enabled		
Onboard Serial Port 1	: 3F8/IRQ4	ESC : Quit	↑ ↓ ← : Select Item
Onboard Serial Port 2	: 2F8/IRQ3	F1 : Help	PU/PD/+/- : Modify
Uart 2 Mode	: Standard	F5 : Old Values	(Shift) F2 : Color
		F6 : Load BIOS Defaults	
		F7 : Load Setup Defaults	

OnChip Primary/Secondary PCI IDE

These fields allow you either to enable or disable the Primary/Secondary controller. You might choose to disable the controller if you were to add a higher performance or specialized controller.

IDE Prefetch Mode

This field allows your hard disk controller to use prefetch mode to transfer data to increase the performance.

IDE HDD Block Mode

This field allows your hard disk controller to use the fast block mode to transfer data to and from your hard disk drive.

IDE Primary/Secondary Master/Slave PIO

These fields allow your system hard disk controller to work faster. Rather than have the BIOS issue a series of commands that transfer to or from the disk drive, PIO (Programmed Input/Output) allows the BIOS to communicate with the controller and CPU directly.

The system supports five modes, numbered from 0 (default) to 4, which primarily differ in timing. When Auto is selected, the BIOS will select the best available mode.

IDE Primary/Secondary Master/Slave UDMA

This field allows your system to improve disk I/O throughput to 33Mb/sec with the Ultra DMA/33 feature. The options are *Auto* and *Disabled*.

Init Display First

This field allows the system to initialize first the VGA card in the AGP slot or in the PCI slot on the motherboard when system is turned on. The default setting is *AGP*.

Onboard FDD Controller

This option allows you to select the onboard FDD port.

Onboard Serial/Parallel Port

These fields allow you to select the onboard serial and parallel ports and their addresses. The default values for these ports are:

Serial Port 1	3F8/IRQ4
Serial Port 2	2F8/IRQ3
Parallel Port	378H/IRQ7

UART 2 Mode

This field determines the UART 2 mode in your computer. The options are *Standard*, *HPSIR*, and *ASKIR*.

Onboard Parallel Mode

This field allows you to determine parallel port mode function.

SPP	Normal Printer Port
EPP	Enhanced Parallel Port
ECP	Extended Capabilities Port

6.11 Supervisor / User Password

These two options set the system password. *Supervisor Password* sets a password that will be used to protect the system and Setup utility. *User Password* sets a password that will be used exclusively on the system. To specify a password, highlight the type you want and press <Enter>. The **Enter Password:** message prompts on the screen. Type the password, up to eight characters in length, and press <Enter>. The system confirms your password by asking you to type it again. After setting a password, the screen automatically returns to the main screen.

To disable a password, just press the <Enter> key when you are prompted to enter the password. A message will confirm the password to be disabled. Once the password is disabled, the system will boot and you can enter Setup freely.

ROM PCI/ISA BIOS CMOS SETUP UTILITY AWARD SOFTWARE, INC.	
STANDARD CMOS SETUP	INTEGRATED PERIPHERALS
BIOS FEATURES SETUP	SUPERVISOR PASSWORD
CHIPSET FEATURES SETUP	USER PASSWORD
POWER MANAGE	DETECTION
PNP/PCI CONF	FORMAT
LOAD BIOS DEF	UP
LOAD SETUP D	AVING
ESC : Quit	↑ ↓ → ← : Select Item
F10 : Save & Exit Setup	(Shift) F2 : Change Color
Change / Set / Disable Password	

6.12 IDE HDD Auto Detection

This option detects the parameters of an IDE hard disk drive, and automatically enters them into the Standard CMOS Setup screen.

ROM PCI/ISA BIOS
STANDARD CMOS SETUP
AWARD SOFTWARE, INC.

HARD DISKS	TYPE	SIZE	CYLS	HEAD	PRECOMP	LANDZ	SECTOR	MODE
Primary Master:								
Select Primary Master Option (N=SKIP) : N								
OPTIONS	TYPE	SIZE	CYLS	HEAD	PRECOMP	LANDZ	SECTOR	MODE
1 (Y)	0	0	0	0	0	0	0	NORMAL

NOTE: Some OSes (like SCO-UNIX) must use "NORMAL" for installation

Up to four IDE drives can be detected, with parameters for each appearing in sequence inside a box. To accept the displayed entries, press the "Y" key; to skip to the next drive, press the "N" key. If you accept the values, the parameters will appear listed beside the drive letter on the screen.

6.13 HDD Low Level Format

This option should only be used by a professional. Low-level formatting can cause irreparable damage to your hard disk. The procedures include selecting the drive you want to low-level format, determining the bad tracks, and proceeding with pre-formatting.

6.14 Save & Exit Setup

This option allows you to determine whether to accept the modifications or not. If you type “Y”, you will quit the setup utility and save all changes into the CMOS memory. If you type “N”, you will return to Setup utility.

ROM PCI/ISA BIOS
CMOS SETUP UTILITY
AWARD SOFTWARE, INC.

STANDARD CMOS SETUP	INTEGRATED PERIPHERALS
BIOS FEATURES SETUP	SUPERVISOR PASSWORD
CHIPSET FEATURES SETUP	USER PASSWORD
POWER MANAGE	DETECTION
PNP/PCI CONF	FORMAT
LOAD BIOS DEF	UP
LOAD SETUP DEFAULTS	EXIT WITHOUT SAVING
ESC : Quit	↑ ↓ → ← : Select Item
F10 : Save & Exit Setup	(Shift) F2 : Change Color
Save Data to CMOS & Exit Setup	

6.15 Exit Without Saving

Select this option to exit the Setup utility without saving the changes you have made in this session. Typing “Y” will quit the Setup utility without saving the modifications. Typing “N” will return you to Setup utility.

ROM PCI/ISA BIOS
CMOS SETUP UTILITY
AWARD SOFTWARE, INC.

STANDARD CMOS SETUP	INTEGRATED PERIPHERALS
BIOS FEATURES SETUP	SUPERVISOR PASSWORD
CHIPSET FEATURES SETUP	USER PASSWORD
POWER MANAGE	DETECTION
PNP/PCI CONF	FORMAT
LOAD BIOS DEF	UP
LOAD SETUP DEFAULTS	EXIT WITHOUT SAVING
ESC : Quit	↑ ↓ → ← : Select Item
F10 : Save & Exit Setup	(Shift) F2 : Change Color
Abandon all Data & Exit Setup	

Chapter 7 System Monitor User's Guide

This chapter introduces System Monitor utility that comes with the motherboard in conjunction with the onboard hardware monitoring IC. The sections below give the functions of the utility.

System Monitor is a utility that oversee the general performance of systems, covering areas like system temperature, system voltage, CPU and system fan rotational speeds. If conditions become adversed, that is, when voltages are erratic or CPU temperature exceeds the safe limits, an alarm will be sounded; thereby preventing system crashing and ensuring overall stability.

NOTE: System Monitor currently supports English and Chinese under Windows 95 and Windows NT. English will be used for other language environments.

When System Monitor is initiated, the icon below appears in the task bar in the Windows environment.



The following screen appears upon clicking on the System Monitor icon.

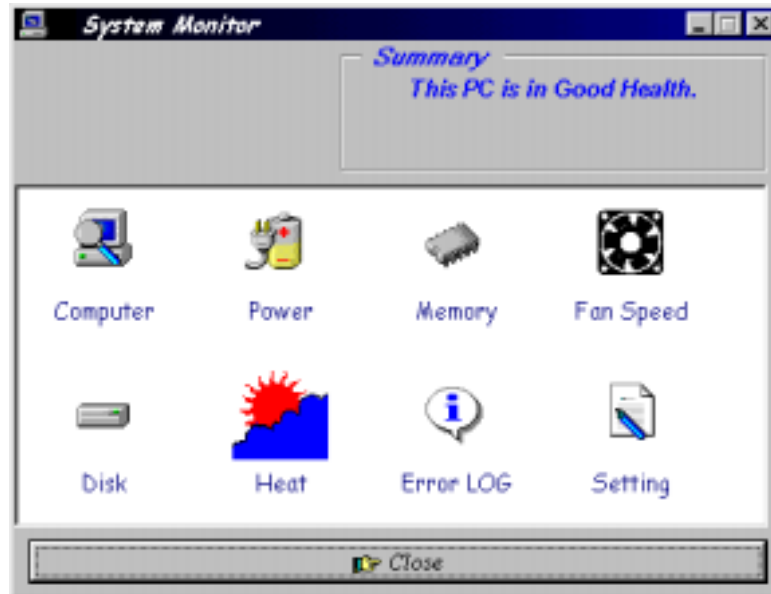

Clicking on the upper left corner button would show you the latest company information. "Summary" provides the current system status.

The section below describes the different functions of System Monitor.

1. Computer - displays the current working system version and processor type.

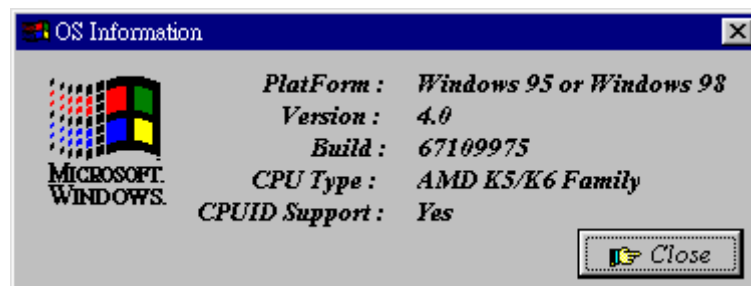

2. Power - displays the current voltage status.

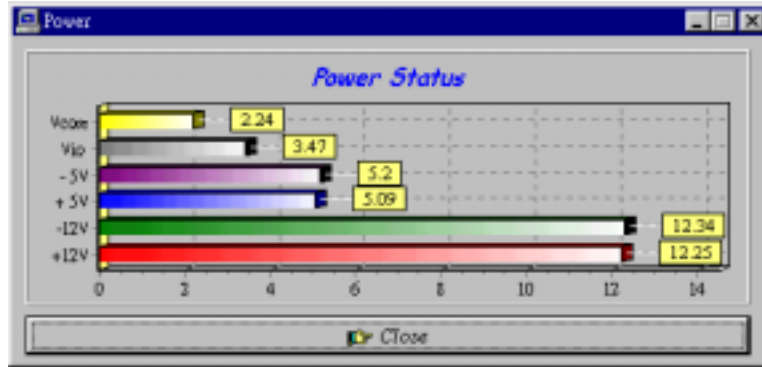

3. Memory - displays the current memory usage status.

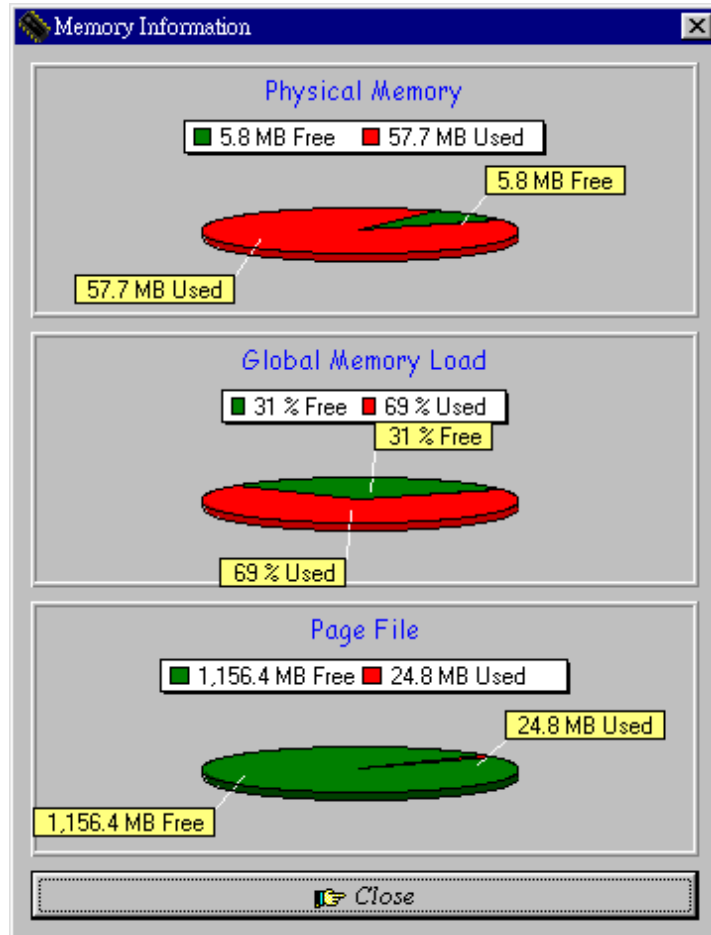

- Fan Speed - displays the current rotational speeds of CPU and Chassis fans.

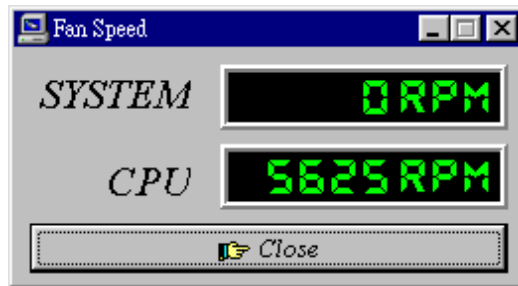

- Disk - displays the disk supported formats and disk space.

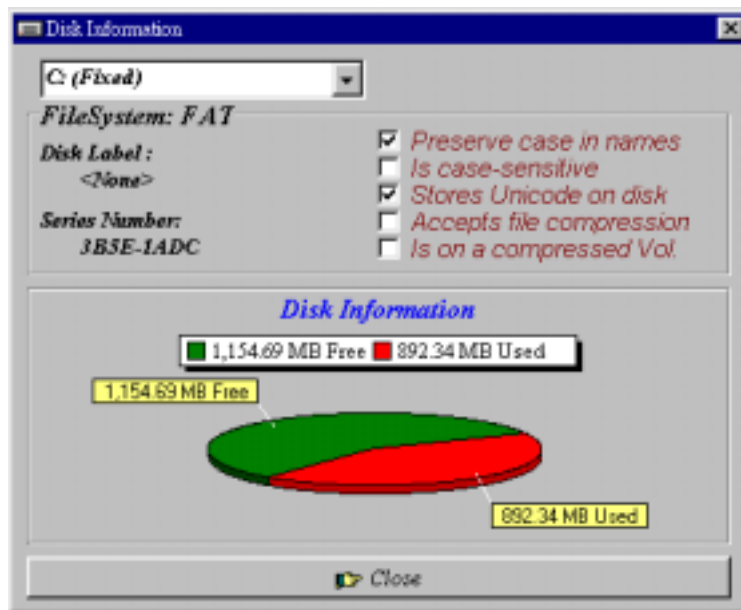

- Heat - displays the CPU and system temperatures.

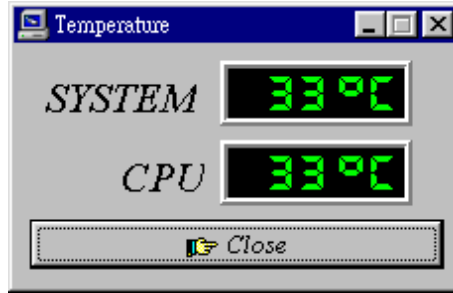

- Error Log - displays errors occurring after System Monitor is started.

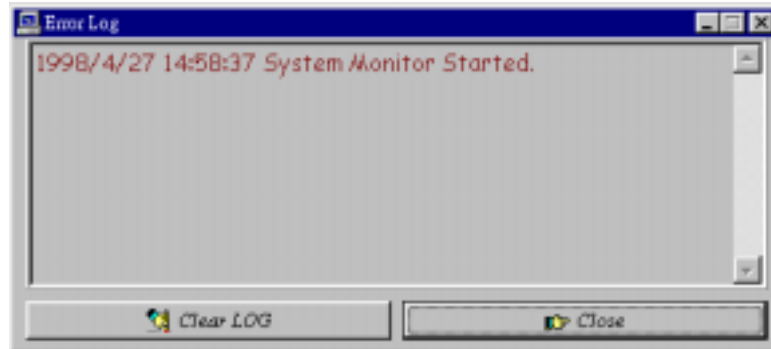

8. Setting - sets the values at which an alarm is sounded.

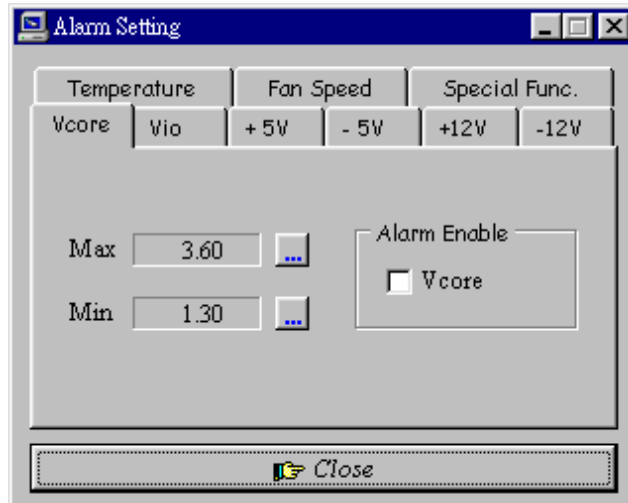

Voltage : the acceptable voltage range between the "MAX"
Temperature : temperature threshold.
Fan Rotation Speed : the minimum rotation speed.

NOTE: Intel has defined a margin of difference for the voltages as below:
12 Volts - 10% (10.8V ~ 13.2V)
5 Volts - 5% (4.75 ~ 5.25%)
Vio - 5% (Vio for P54C CPU is 3.5V. Vio for P55C is 3.3V.)
Vcore- 5%