

## **FCC Information and Copyright**

This equipment has been tested and found to comply with the limits of a Class B digital device, pursuant to Part 15 of the FCC Rules. These limits are designed to provide reasonable protection against harmful interference in a residential installation. This equipment generates, uses and can radiate radio frequency energy and, if not installed and used in accordance with the instructions, may cause harmful interference to radio communications. There is no guarantee that interference will not occur in a particular installation.

The vendor makes no representations or warranties with respect to the contents here and specially disclaims any implied warranties of merchantability or fitness for any purpose. Further the vendor reserves the right to revise this publication and to make changes to the contents here without obligation to notify any party beforehand.

Duplication of this publication, in part or in whole, is not allowed without first obtaining the vendor's approval in writing.

The content of this user's manual is subject to be changed without notice and we will not be responsible for any mistakes found in this user's manual. All the brand and product names are trademarks of their respective companies.

## Table of Contents

<b>Chapter 1: Introduction</b>	<b>1</b>
1.1 Before You Start	1
1.2 Package Checklist	1
1.3 Motherboard Features	2
1.4 Rear Panel Connectors	3
1.5 Motherboard Layout	4
<b>Chapter 2: Hardware Installation</b>	<b>5</b>
2.1 Installing Central Processing Unit (CPU)	5
2.2 FAN Headers	7
2.3 Installing System Memory	8
2.4 2.4 Connectors and Slots	10
<b>Chapter 3: Headers &amp; Jumpers Setup</b>	<b>12</b>
3.1 How to Setup Jumpers	12
3.2 Detail Settings	12
<b>Chapter 4: NVIDIA RAID Functions</b>	<b>21</b>
4.1 Operation System	21
4.2 Raid Arrays	21
4.3 How RAID Works	21
<b>Chapter 5: OverClock Quick Guide</b>	<b>25</b>
5.1: T-Power Introduction	25
5.2: T-Power BIOS Feature	26
5.3 T-Power Windows Feature	34
<b>Chapter 6: Useful Help</b>	<b>43</b>
6.1 Driver Installation Note	43
6.2 Award BIOS Beep Code	44
6.3 Extra Information	44
6.4 Troubleshooting	46
<b>Appendencies: SPEC In Other Language</b>	<b>48</b>
German	48
France	50
Italian	52
Spanish	54
Portuguese	56
Polish	58
RUSSIAN	60
ARABIC	62
JAPANESE	64

---

---

## **CHAPTER 1: INTRODUCTION**

### **1.1 BEFORE YOU START**

Thank you for choosing our product. Before you start installing the motherboard, please make sure you follow the instructions below:

- Prepare a dry and stable working environment with sufficient lighting.
- Always disconnect the computer from power outlet before operation.
- Before you take the motherboard out from anti-static bag, ground yourself properly by touching any safely grounded appliance, or use grounded wrist strap to remove the static charge.
- Avoid touching the components on motherboard or the rear side of the board unless necessary. Hold the board on the edge, do not try to bend or flex the board.
- Do not leave any unfastened small parts inside the case after installation. Loose parts will cause short circuits which may damage the equipment.
- Keep the computer from dangerous area, such as heat source, humid air and water.

### **1.2 PACKAGE CHECKLIST**

- ✚ FDD Cable X 1
- ✚ HDD Cable X 1
- ✚ Serial ATA Cable X 1
- ✚ Serial ATA Power Cable X 1
- ✚ Rear I/O Panel for ATX Case X 1
- ✚ User's Manual X 1
- ✚ Fully Setup Driver CD X 1
- ✚ USB 2.0 Cable X1 (optional)
- ✚ S/PDIF out Cable X 1 (optional)

## 1.3 MOTHERBOARD FEATURES

SPEC		
CPU	Socket AM2 AMD Athlon 64 / Athlon 64 FX / Athlon 64 x2 / Sempron processors	AMD 64 Architecture enables 32 and 64 bit computing Supports Hyper Transport and Cool'n-Quiet
FSB	Support HyperTransport	Supports up to 1 GHz Bandwidth
Chipset	nForce 570 Ultra	
Super I/O	ITE 8716F Provides the most commonly used legacy Super I/O functionality. Low Pin Count Interface	Environment Control initiatives, H/W Monitor Fan Speed Controller ITE's "Smart Guardian" function
Main Memory	DIMM Slots x 4 Each DIMM supports 256/512MB & 1GB DDR2 Max Memory Capacity 4GB	Dual Channel Mode DDR2 memory module Supports DDR2 533 / 667 / 800 Registered DIMM and ECC DIMM is not supported
IDE	Integrated IDE Controller Ultra DMA 33 / 66 / 100 / 133 Bus Master Mode	supports PIO Mode 0~4,
SATA II	Integrated Serial ATA Controller Data transfer rates up to 3 Gb/s.	SATA Version 2.0 specification compliant.
LAN	Marvell 88E1116 PHY	10 / 100 Mb/s and 1Gb/s Auto-Negotiation
Sound	Realtek ALC888	8 channels audio out Supports HD Audio
Slots	PCI slot x3 PCI Express x16 slot x1 PCI Express x 1 slot x3	Supports PCI expansion cards Supports PCI express x16 expansion cards Supports PCI express x1 expansion cards
On Board Connector	Floppy connector x1 Printer Port connector x1 IDE Connector x1 SATA Connector x6 Front Panel Connector x1 Front Audio Connector x1 CD-in Connector x1 S/PDIF out connector x1 CPU Fan header x1	Each connector supports 2 Floppy drives Each connector supports 1 Printer port Each connector supports 2 IDE device Each connector supports 1 SATA devices Supports front panel facilities Supports front panel audio function Supports CD audio-in function Supports digital audio out function CPU Fan power supply (with Smart Fan function)

SPEC			
	System Fan header	x3	System Fan Power supply
	Chassis open header (optional)	x1	For chassis intruder detection function
	CMOS clear header	x1	Restore CMOS data to factory default
	USB connector	x2	Each connector supports 2 front panel USB ports
	Power Connector (24pin)	x1	Connects to Power supply
	Power Connector (8pin)	x1	Connects to Power supply
Back Panel I/O	PS/2 Keyboard	x1	Connects to PS/2 Keyboard
	PS/2 Mouse	x1	Connects to PS/2 Mouse
	Serial Port	x1	Connects to RS-232 devices
	LAN port	x1	Connects to RJ-45 ethernet cable
	USB Port	x6	Connects to USB devices
	Audio Jack	x6	Provide Audio-In/Out and microphone connection
Board Size	244 x 305 (mm)		ATX Size Board
Special Features	NVIDIA nTunes		Tuning and monitoring system performance
	RAID 0 / 1 / 0+1 / 5 support		Supports Raid 0 / 1 / 0+1 / 5 through SATA connector.
OS Support	Windows 2000 / XP		Biostar Reserves the right to add or remove support for any OS With or without notice.

### 1.4 REAR PANEL CONNECTORS

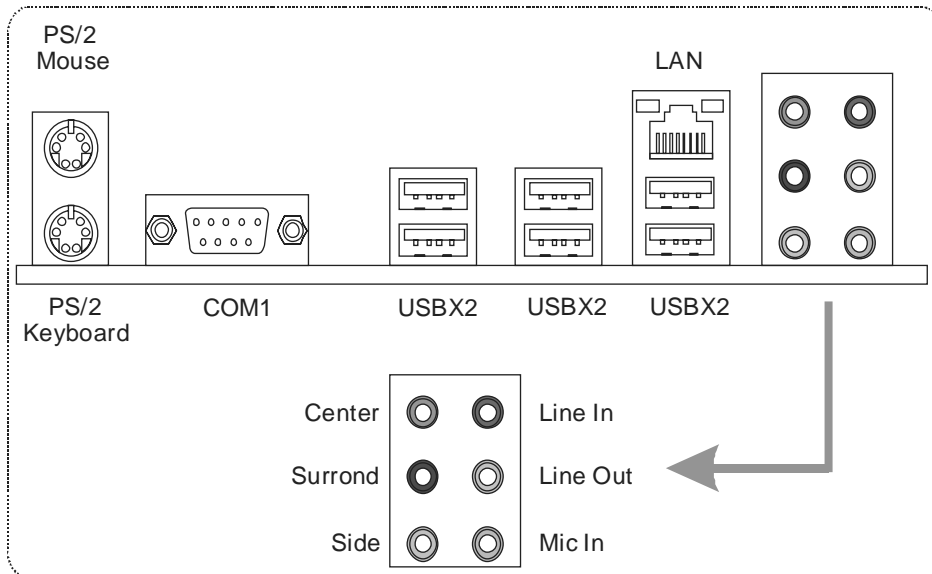

## 1.5 MOTHERBOARD LAYOUT

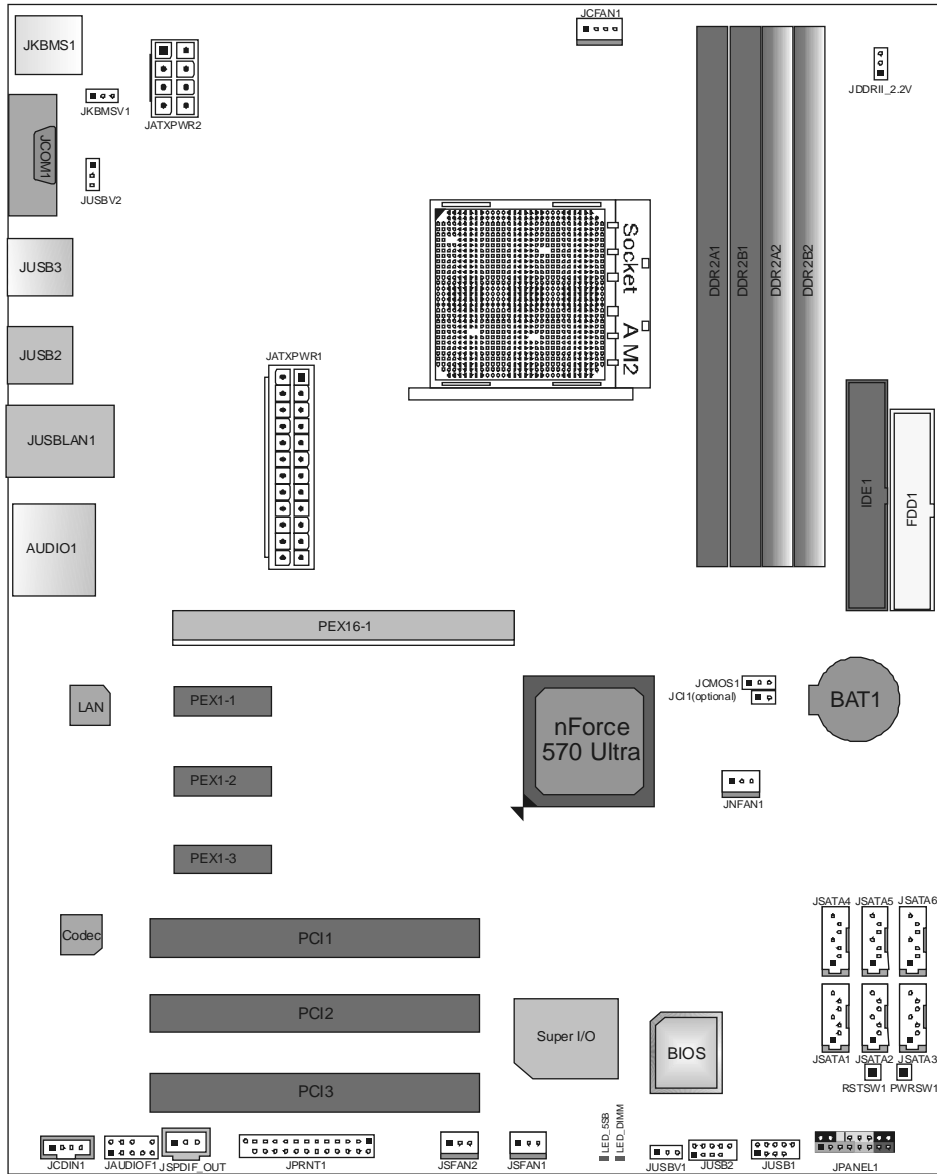

**Note:** ■ represents the 1<sup>st</sup> pin.

---

## CHAPTER 2: HARDWARE INSTALLATION

### 2.1 INSTALLING CENTRAL PROCESSING UNIT (CPU)

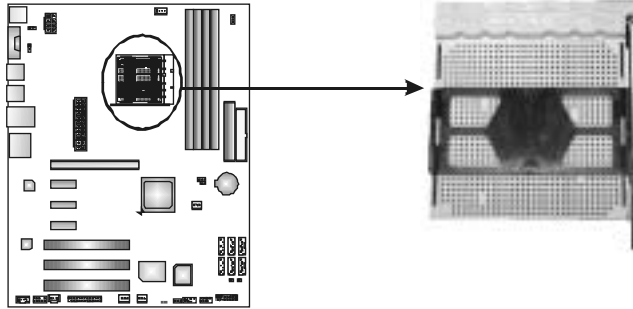

**Step 1:** Remove the socket protection cap.

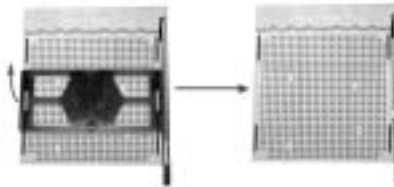

**Step 2:** Pull the lever toward direction A from the socket and then raise the lever up to a 90-degree angle.

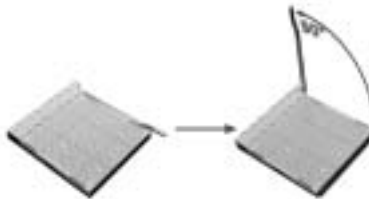

**Step 3:** Look for the white triangle on socket, and the gold triangle on CPU should point towards this white triangle. The CPU will fit only in the correct orientation.



**Step 4:** Hold the CPU down firmly, and then close the lever toward direct B to complete the installation.

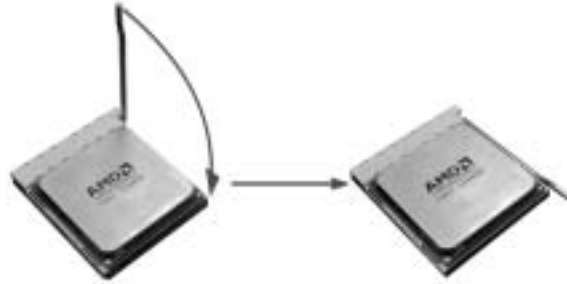

**Step 5:** Put the CPU Fan on the CPU and buckle it. Connect the CPU FAN power cable to the JCFAN1. This completes the installation.



## 2.2 FAN HEADERS

These fan headers support cooling-fans built in the computer. The fan cable and connector may be different according to the fan manufacturer. Connect the fan cable to the connector while matching the black wire to pin#1.

### JCFAN1: CPU Fan Header

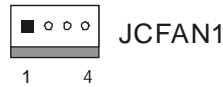
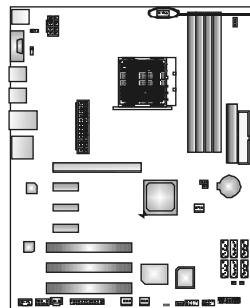

Pin	Assignment
1	Ground
2	Smart Fan Control
3	FAN RPM rate sense
4	Smart Fan Control (By Fan)

### JSFAN1/ JSFAN2: System Fan Header

#### JNFAN1: North Bridge Fan Header

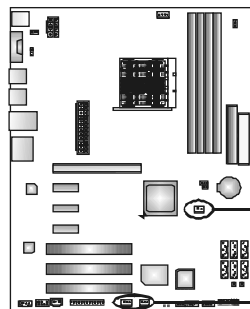

<i>JSFAN1</i>	
Pin	Assignment
1	Ground
2	Smart Fan Control
3	FAN RPM rate sense

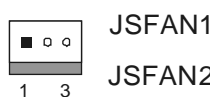

<i>JNFAN1, JSFAN2</i>	
Pin	Assignment
1	Ground
2	+12V
3	FAN RPM rate sense

#### **Note:**

The JCFAN1、JSFAN1/JSFAN2 and JNFAN1 support 4-pin and 3-pin head connector. When connecting with wires onto connectors, please note that the red wire is the positive and should be connected to pin#2, and the black wire is Ground and should be connected to GND.

## 2.3 INSTALLING SYSTEM MEMORY

### A. Memory Modules

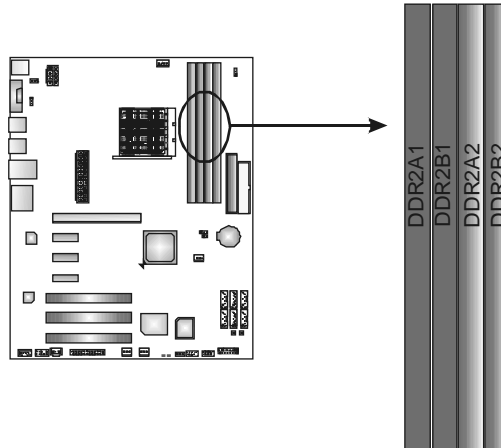

1. Unlock a DIMM slot by pressing the retaining clips outward. Align a DIMM on the slot such that the notch on the DIMM matches the break on the Slot.

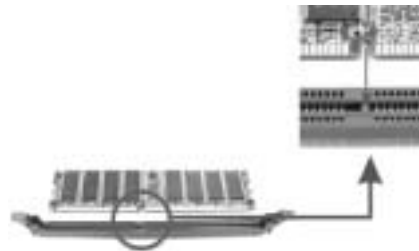

2. Insert the DIMM vertically and firmly into the slot until the retaining chip snap back in place and the DIMM is properly seated.



**B. Memory Capacity**

DIMM Socket Location	DDR Module	Total Memory Size
DDR2A1	256MB/512MB/1024MB	Max is 4GB.
DDR2B1	256MB/512MB/1024MB	
DDR2A2	256MB/512MB/1024MB	
DDR2B2	256MB/512MB/1024MB	

**C. Dual Channel Memory installation**

To trigger the Dual Channel function of the motherboard, the memory module must meet the following requirements:

Install memory module of the same density in pairs, shown in the following table.

Dual Channel Status	DDR2A1	DDR2B1	DDR2A2	DDR2B2
Enabled	O	O	X	X
Enabled	X	X	O	O
Enabled	O	O	O	O

(O means memory installed, X means memory not installed.)

The DRAM bus width of the memory module must be the same (x8 or x16)

## 2.4 2.4 CONNECTORS AND SLOTS

### FDD1: Floppy Disk Connector

The motherboard provides a standard floppy disk connector that supports 360K, 720K, 1.2M, 1.44M and 2.88M floppy disk types. This connector supports the provided floppy drive ribbon cables.

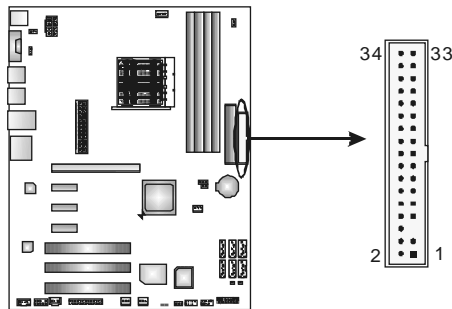

### IDE1: Hard Disk Connector

The motherboard has a 32-bit Enhanced IDE Controller that provides PIO Mode 0~4, Bus Master, and Ultra DMA 33/66/100/133 functionality.

The IDE connector can connect a master and a slave drive, so you can connect up to two hard disk drives.

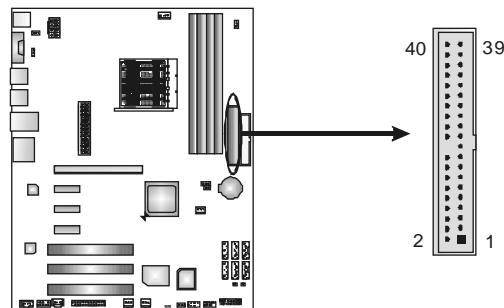

### PCI-Ex16: PCI-Express x16 Slot

- PCI-Express 1.0a compliant.
- Maximum theoretical realized bandwidth of 4GB/s simultaneously per direction, for an aggregate of 8GB/s totally.

### PCI-Ex1\_1/PCI-Ex1\_2/ PCI-Ex1\_3: PCI-Express x1 slots

- PCI-Express 1.0a compliant.
- Data transfer bandwidth up to 250MB/s per direction; 500MB/s in total.
- PCI-Express supports a raw bit-rate of 2.5Gb/s on the data pins.
- 2X bandwidth over the traditional PCI architecture.

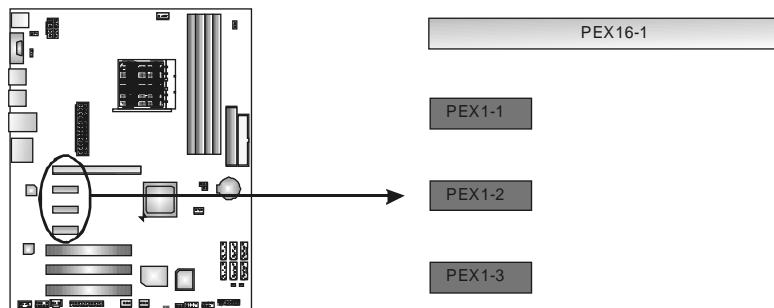

### PCI1~PCI3: Peripheral Component Interconnect Slots

This motherboard is equipped with 3 standard PCI slots. PCI stands for Peripheral Component Interconnect, and it is a bus standard for expansion cards. This PCI slot is designated as 32 bits.

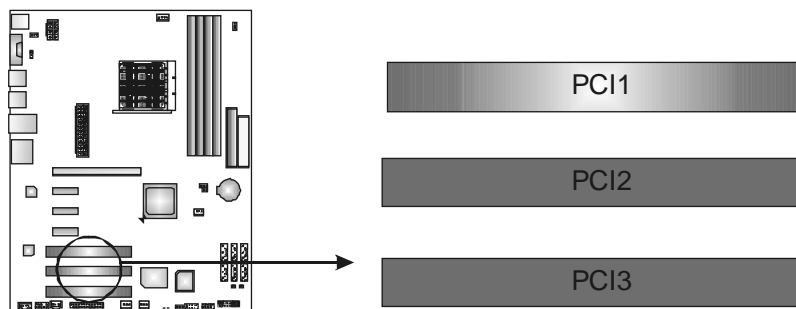

## CHAPTER 3: HEADERS & JUMPERS SETUP

### 3.1 HOW TO SETUP JUMPERS

The illustration shows how to set up jumpers. When the jumper cap is placed on pins, the jumper is “close”, if not, that means the jumper is “open”.



### 3.2 DETAIL SETTINGS

#### JPANEL1: Front Panel Header

This 16-pin connector includes Power-on, Reset, HDD LED, Power LED, Sleep button and speaker connection. It allows user to connect the PC case’s front panel switch functions.

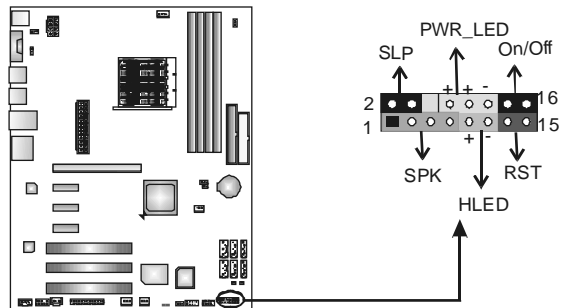

Pin	Assignment	Function	Pin	Assignment	Function
1	+5V	Speaker Connector	9	Sleep control	Sleep button
2	N/A		10	Ground	
3	N/A		11	N/A	N/A
4	Speaker	Hard drive LED	12	Power LED (+)	Power LED
5	HDD LED (+)		13	Power LED (+)	
6	HDD LED (-)		14	Power LED (-)	
7	Ground	Reset button	15	Power button	Power-on button
8	Reset control		16	Ground	

### JATXPWR1: ATX Power Source Connector

This connector allows user to connect 24-pin power connector on the ATX power supply.

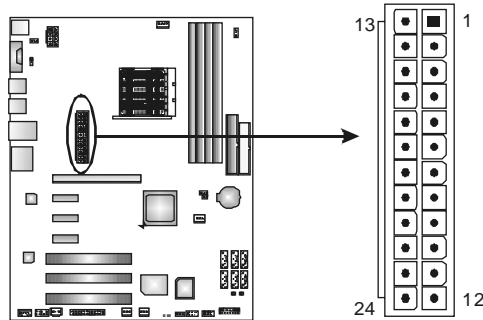

Pin	Assignment	Pin	Assignment
13	+3.3V	1	+3.3V
14	-12V	2	+3.3V
15	Ground	3	Ground
16	PS_ON	4	+5V
17	Ground	5	Ground
18	Ground	6	+5V
19	Ground	7	Ground
20	NC	8	PW_OK
21	+5V	9	Standby Voltage+5V
22	+5V	10	+12V
23	+5V	11	+12V
24	Ground	12	+3.3V

### JATXPWR2: ATX Power Source Connector

By connecting this connector, it will provide +12V to CPU power circuit.

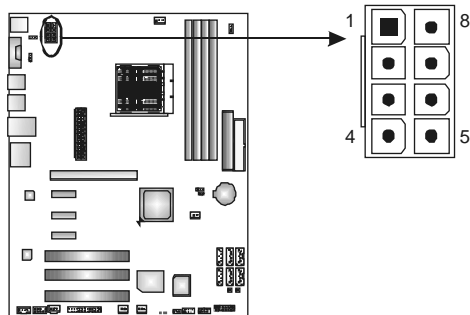

Pin	Assignment
1	+12V
2	+12V
3	+12V
4	+12V
5	Ground
6	Ground
7	Ground
8	Ground

### JKBMSV1: Power Source Selection Headers for Keyboard/Mouse

**Pin 1-2 Close:**

JKBMSV1: +5V for PS/2 keyboard and mouse.

**Pin 2-3 Close:**

JKBMSV1: PS/2 keyboard and mouse are powered with +5V standby voltage.

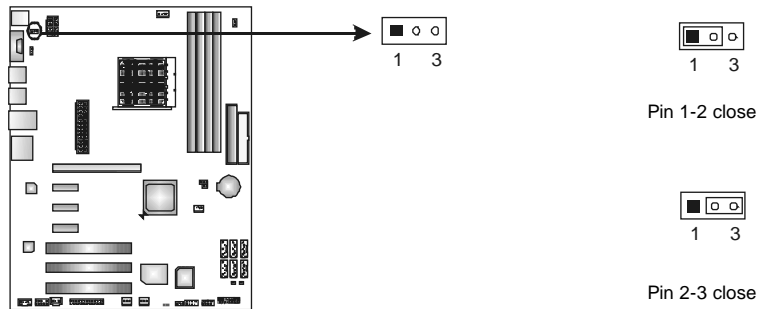

### JUSB1/JUSB2: Headers for USB 2.0 Ports at Front Panel

This header allows user to connect additional USB cable on the PC front panel, and also can be connected with internal USB devices, like USB card reader.

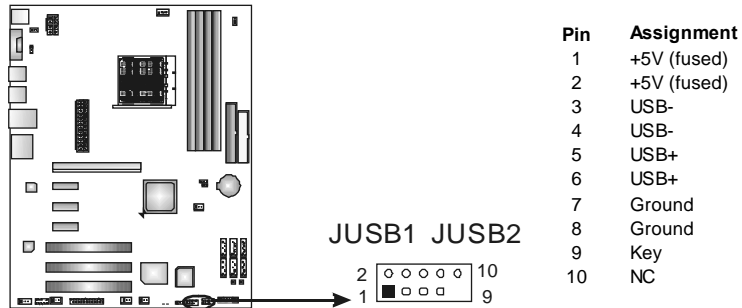



### JUSBV1/JUSBV2: Power Source Headers for USB Ports

**Pin 1-2 Close:**

JUSBV1: +5V for USB ports at JUSBLAN1.

JUSBV2: +5V for USB ports at front panel (JUSB1/JUSB2).

**Pin 2-3 Close:**

JUSBV1: USB ports at JUSBLAN1 are powered by +5V standby voltage.

JUSBV2: USB ports at front panel (JUSB1/JUSB2) are powered by +5V standby voltage.

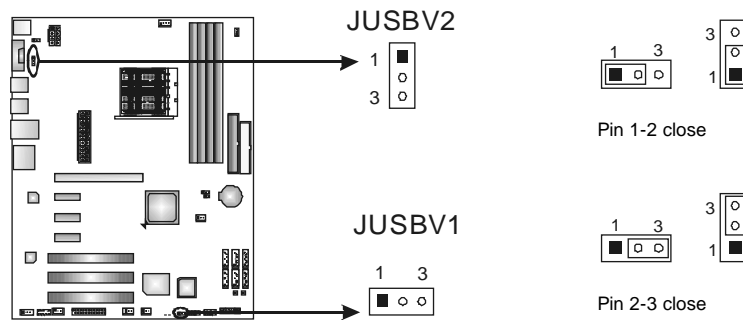

**Note:**

In order to support this function “Power-On system via USB device,” “JUSBV1/ JUSBV2” jumper cap should be placed on Pin 2-3 individually.

### JAUDIOF1: Front Panel Audio Header

This header allows user to connect the front audio output cable with the PC front panel. It will disable the output on back panel audio connectors.

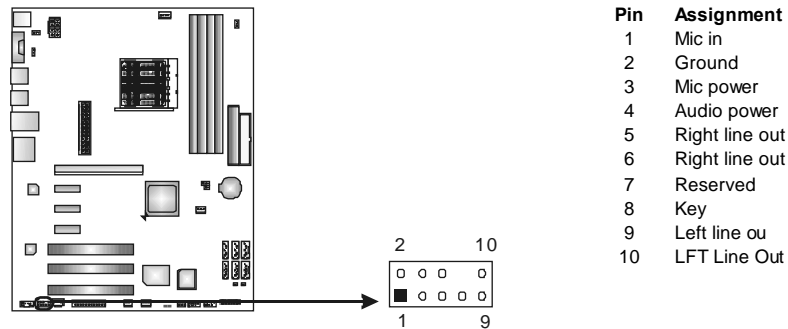

### JCDIN1: CD-ROM Audio-in Connector

This connector allows user to connect the audio source from the variety devices, like CD-ROM, DVD-ROM, PCI sound card, PCI TV turner card etc.

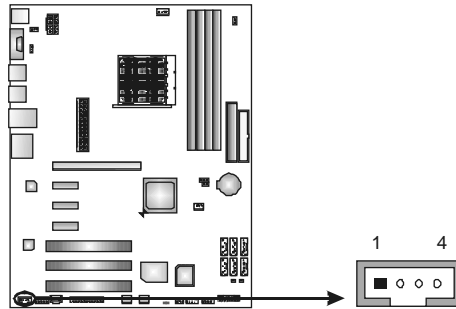

Pin	Assignment
1	Left Channel Input
2	Ground
3	Ground
4	Right Channel Input

### JCMOS1: Clear CMOS Header

By placing the jumper on pin2-3, it allows user to restore the BIOS safe setting and the CMOS data, please carefully follow the procedures to avoid damaging the motherboard.

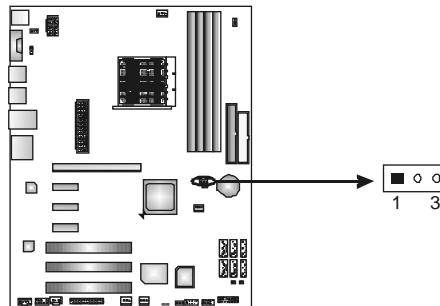

**Pin 1-2 Close:**  
Normal Operation (default).



**Pin 2-3 Close:**  
Clear CMOS data.

#### ※ Clear CMOS Procedures:

1. Remove AC power line.
2. Set the jumper to "Pin 2-3 close".
3. Wait for five seconds.
4. Set the jumper to "Pin 1-2 close".
5. Power on the AC.
6. Reset your desired password or clear the CMOS data.

### JCI1: Chassis Open Header (Optional)

This connector allows system to monitor PC case open status. If the signal has been triggered, it will record to the CMOS and show the message on next boot-up.

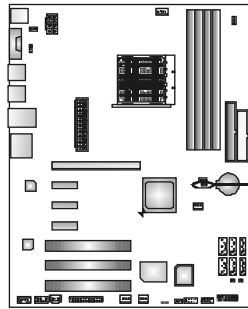

Pin	Assignment
1	Case open signal
2	Ground

### JPRNT1: Printer Port Connector

This header allows you to connector printer on the PC.

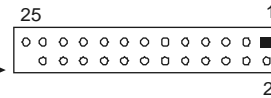
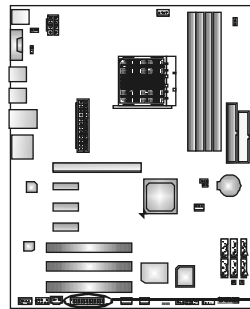

Pin	Assignment	Pin	Assignment
1	-Strobe	14	Ground
2	-ALF	15	Data 6
3	Data 0	16	Ground
4	-Error	17	Data 7
5	Data 1	18	Ground
6	-Init	19	-ACK
7	Data 2	20	Ground
8	-Scltin	21	Busy
9	Data 3	22	Ground
10	Ground	23	PE
11	Data 4	24	Ground
12	Ground	25	SCLT
13	Data 5		

### JSATA1~JSATA6: Serial ATA Connectors

The motherboard has a PCI to SATA Controller with 6 channels SATA interface, it satisfies the SATA 2.0 spec and with transfer rate of 3.0Gb/s.

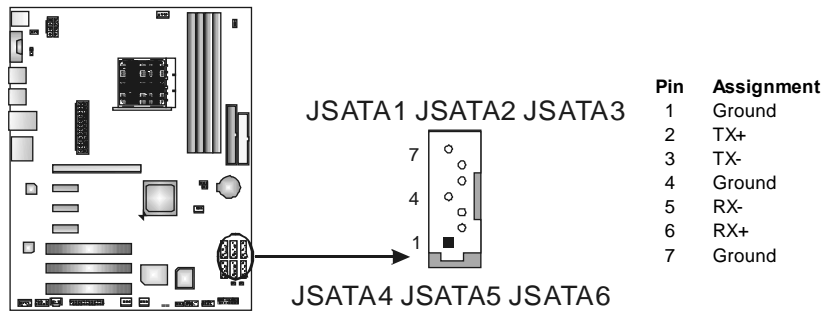

### Header for Memory over-voltage: JDDRIL\_2.2V

When processing Memory over-voltage, please place the jumper to pin2-3 Closed. The Default setting is Pin 1-2 Closed.

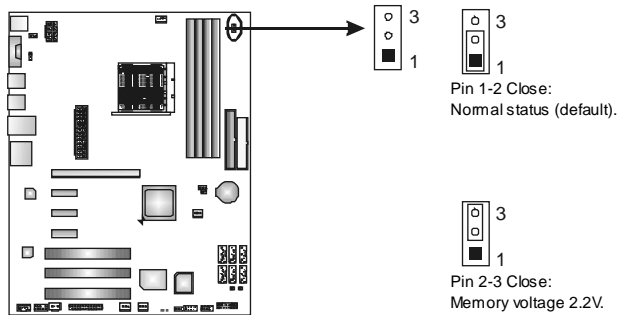

**Note:**

1. When "JDDRIL\_2.2V" jumper cap is placed on Pin 1-2, memory voltage can be manually adjusted in CMOS setup screen.
2. When "JDDRIL\_2.2V" jumper cap is placed on Pin 2-3, memory voltage will be fixed at 2.2V automatically, and can't be adjusted under COMS setup.

Before setting memory over-voltage, please ensure that your DDR2 supports up to 2.2V. (Consult your DDR2 supplier)

### On-Board LED Indicators

There are 2 LED indicators on the motherboard to show system status.

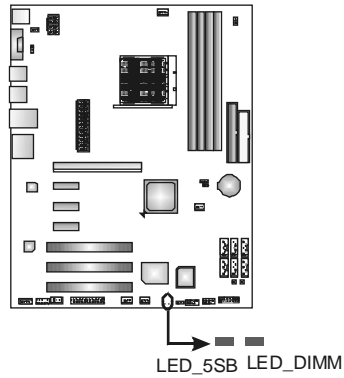

#### **LED\_DIMM:**

This LED indicates the voltage of memory is activated normally.

#### **LED\_5SB:**

This LED indicates the system is ready for Power-on.

### On-Board Buttons

There are 2 on-board buttons.

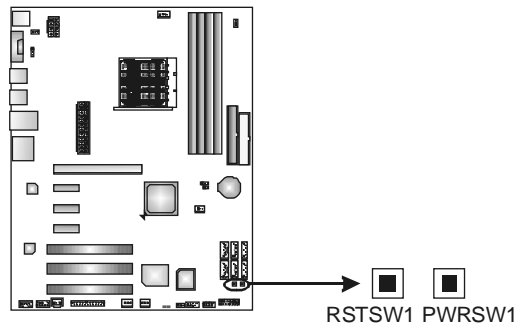

#### **PWRSW1:**

This is an on-board Power Switch button.

#### **RSTSW1:**

This is an on-board Reset button.

### JSPDIF\_OUT1: Digital Audio-out Connector

This connector allows user to connect the PCI bracket SPDIF output header.

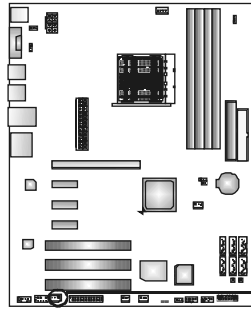

Pin	Assignment
1	+5V
2	SPDIF_OUT
3	Ground

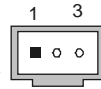

---



---

## CHAPTER 4: NVIDIA RAID FUNCTIONS

### 4.1 OPERATION SYSTEM

Supports Windows XP Home/Professional Edition, and Windows 2000 Professional.

### 4.2 RAID ARRAYS

NVRAID supports the following types of RAID arrays:

**RAID 0:** RAID 0 defines a disk striping scheme that improves disk read and write times for many applications.

**RAID 1:** RAID 1 defines techniques for mirroring data.

**RAID 0+1:** RAID 0+1 combines the techniques used in RAID 0 and RAID 1.

**Spanning (JBOD):** JBOD provides a method for combining drives of different sizes in to one large disk.

**RAID 5:** RAID 5 provides fault tolerance and better utilization of disk capacity.

### 4.3 HOW RAID WORKS

#### **RAID 0:**

The controller “stripes” data across multiple drives in a RAID 0 array system. It breaks up a large file into smaller blocks and performs disk reads and writes across multiple drives in parallel. The size of each block is determined by the stripe size parameter, which you set during the creation of the RAID set based on the system environment. This technique reduces overall disk access time and offers high bandwidth.

#### **Features and Benefits**

- **Drives:** Minimum 1, and maximum is up to 6 or 8. Depending on the platform.
- **Uses:** Intended for non-critical data requiring high data throughput, or any environment that does not require fault tolerance.
- **Benefits:** provides increased data throughput, especially for large files. No capacity loss penalty for parity.
- **Drawbacks:** Does not deliver any fault tolerance. If any drive in the array fails, all data is lost.
- **Fault Tolerance:** No.

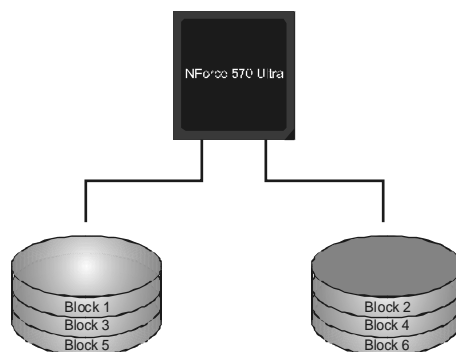

**RAID 1:**

Every read and write is actually carried out in parallel across 2 disk drives in a RAID 1 array system. The mirrored (backup) copy of the data can reside on the same disk or on a second redundant drive in the array. RAID 1 provides a hot-standby copy of data if the active volume or drive is corrupted or becomes unavailable because of a hardware failure.

RAID techniques can be applied for high-availability solutions, or as a form of automatic backup that eliminates tedious manual backups to more expensive and less reliable media.

**Features and Benefits**

- **Drives:** Minimum 2, and maximum is 2.
- **Uses:** RAID 1 is ideal for small databases or any other application that requires fault tolerance and minimal capacity.
- **Benefits:** Provides 100% data redundancy. Should one drive fail, the controller switches to the other drive.
- **Drawbacks:** Requires 2 drives for the storage space of one drive. Performance is impaired during drive rebuilds.
- **Fault Tolerance:** Yes.

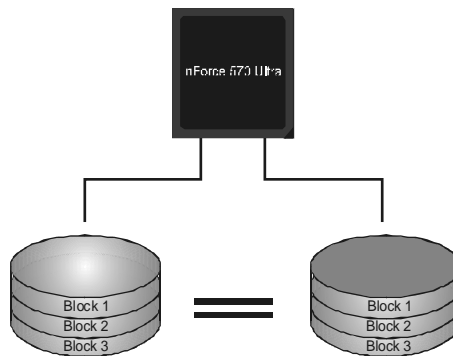



**RAID 0+1:**

RAID 0 drives can be mirrored using RAID 1 techniques. Resulting in a RAID 0+1 solution for improved performance plus resiliency.

**Features and Benefits**

- **Drives:** Minimum 4, and maximum is 6 or 8, depending on the platform.
- **Benefits:** Optimizes for both fault tolerance and performance, allowing for automatic redundancy. May be simultaneously used with other RAID levels in an array, and allows for spare disks.
- **Drawbacks:** Requires twice the available disk space for data redundancy, the same as RAID level 1.
- **Fault Tolerance:** Yes.

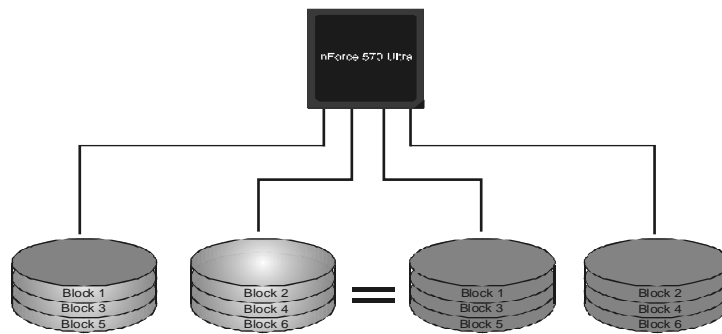
**Spanning (JBOD):**

JBOD stands for “Just a Bunch of Disks”. Each drive is accessed as if it were on a standard SCSI host bus adapter. This is useful when a single drive configuration is needed, but it offers no speed improvement or fault tolerance.

**Features and Benefits**

- **Uses:** JBOD works best if you have odd sized drives and you want to combine them to make one big drive.
- **Benefits:** JBOD provides the ability to combine odd size drives using all of the capacity of the drives.
- **Drawbacks:** Decreases performance because of the difficulty in using drives concurrently.
- **Fault Tolerance:** Yes.



**RAID 5:**

RAID 5 stripes both data and parity information across three or more drives. It writes data and parity blocks across all the drives in the array. Fault tolerance is maintained by ensuring that the parity information for any given block of data is placed on a different drive from those used to store the data itself.

Features and Benefits

- **Drives: Minimum 3.**
- **Uses: RAID 5 is recommended for transaction processing and general purpose service.**
- **Benefits: An ideal combination of good performance, good fault tolerance, and high capacity and storage efficiency.**
- **Drawbacks: Individual block data transfer rate same as a single disk. Write performance can be CPU intensive.**
- **Fault Tolerance: Yes.**

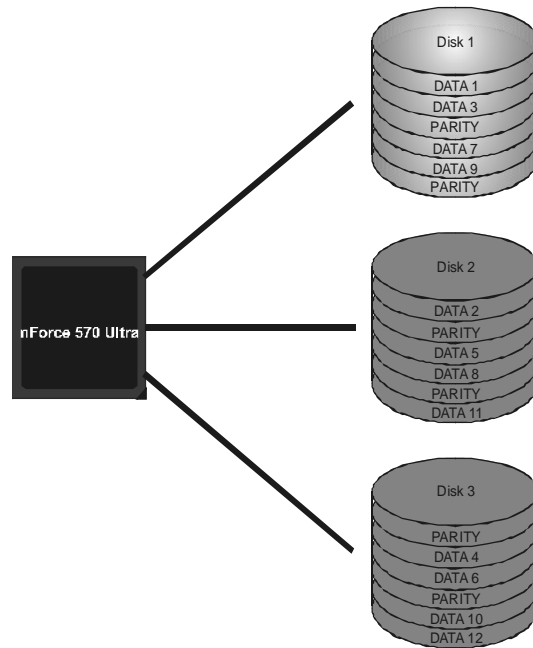

※ For more detailed setup information, please refer to the Driver CD, or go to [http://www.nvidia.com/page/pg\\_20011106217193.html](http://www.nvidia.com/page/pg_20011106217193.html) to download NVIDIA nForce Tutorial Flash.

---

---

## **CHAPTER 5: OVERCLOCK QUICK GUIDE**

### **5.1: T-POWER INTRODUCTION**

*Biostar T-Power* is a whole new utility that is designed for overclock users. Based on many precise tests, *Biostar Engineering Team* (BET) has developed this ultimate overclock engine to raise system performance. No matter whether under BIOS or Windows interface, *T-Power* is able to present the best system state according to users' overclock setting.

#### **T-Power BIOS Features:**

- Overclocking Navigator Engine (O.N.E.)
- CMOS Reloading Program (C.R.P.)
- Memory Integration Test (M.I.T., under Overclock Navigator Engine)
- Integrated Flash Program (I.F.P.)
- Smart Fan Function (under PC Health Status)
- Self Recovery System (S.R.S)

#### **T-Power Windows Feature:**

- Hardware Monitor
- Overclock Engine
- Smart Fan Function
- Life Update

## 5.2: T-POWER BIOS FEATURE

### A. Overclocking Navigator Engine (O.N.E.):

ONE provides two powerful overclocking engines: MOS and AOS for both Elite and Casual overclockers.



### Manual Overclock System (M.O.S.)

MOS is designed for experienced overclock users. It allows users to customize personal overclock settings.

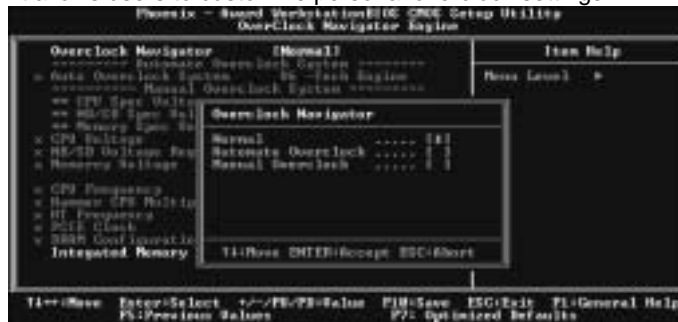

---

---

**CPU Overclock Setting:****CPU Voltage:**

This function will increase CPU stability when overclocking. However, the CPU temperature will increase when CPU voltage is increased.

**Choices:** The range is from 1.2V to 1.725V, with an interval of 0.025V.

**CPU Frequency:**

CPU Frequency is directly in proportion to system performance. To maintain the system stability, CPU voltage needs to be increased also when raising CPU frequency.

**Choices:** This range is from 200 to 450, with an interval of 1MHz.

**Hammer CPU Multiplier:**

The MOS allows users to downgrade the CPU ratio when overclocking.

**Choices:** The lower limit is x4 (800MHz). The upper limit is decided by different CPU type. With an x1 (200MHz) interval.

**Memory Overclock Setting:****Memory Voltage:**

This function will increase memory stability when overclocking.

**Choices:** The range is from 1.85V to 2.0V, with an interval of 0.05V.

**Memclock Frequency:**

To get better system performance, sometimes downgrading the memory frequency is necessary when CPU frequency is adjusted over the upper limit.

**Choices:** DDR2 400, DDR2 533, DDR2 667, DDR2 800 (MHz).

**PCI-Express Overclock Setting:****PCIE Clock:**

It helps to increase VGA card performance.

**Choices:** The range is from 100 to 145, with an interval of 1MHz.

**Chipset Overclock Setting:****NB/SB Voltage Regulator:**

This function will increase chipset stability when overclocking.

**Choices:** 1.52V, 1.60V, 1.68V, 1.76V.

**HT Frequency:**

We recommend users to set this item at "x4" when overclocking.

**Choices:** x1, x2, x3, x4, x5, Auto.

### Automatic Overclock System (A.O.S.)

For beginners in overclock field, BET had developed an easy, fast, and powerful feature to increase the system performance, named A.O.S. Based on many tests and experiments, A.O.S. provides 3 ideal overclock configurations that are able to raise the system performance in a single step.

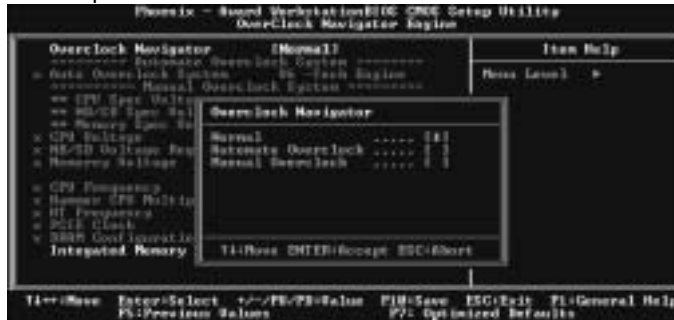

#### V6 Tech Engine:

This setting will raise about 10%~15% of whole system performance.



#### V8 Tech Engine:

This setting will raise about 15%~25% of whole system performance.



**V12 Tech Engine:**

This setting will raise about 25%~30% of whole system performance.

**Notices:**

1. Not all types of AMD CPU perform above overclock setting ideally; the difference will be based on the selected CPU model.
2. From BET experiments, the Athlon64 FX CPU is not suitable for this A.O.S. feature.

**B. CMOS Reloading Program (C.R.P.):**

It allows users to save different CMOS settings into BIOS-ROM.

Users are able to reload any saved CMOS setting for customizing system configurations.

Moreover, users are able to save an ideal overclock setting during overclock operation.

There are 50 sets of record addresses in total, and users are able to name the CMOS data according to personal preference.



**C. Memory Integration Test (M.I.T.):**

This function is under “Overclocking Navigator Engine” item. MIT allows users to test memory compatibilities, and no extra devices or software are needed.

**Step 1:**

The default setting under this item is “Disabled”; the condition parameter should be changed to “Enable” to proceed this test.



**Step 2:**

Save and Exit from CMOS setup and reboot the system to activate this test. Run this test for 5 minutes (minimum) to ensure the memory stability.

**Step 3:**

When the process is done, change the setting back from “Enable” to “Disable” to complete the test.



**D. Self Recovery System (S.R.S.):**

This function can't be seen under T-Power BIOS setup; and is always on whenever the system starts up.

However, it can prevent system hang-up due to inappropriate overclock actions.

When the system hangs up, S.R.S. will automatically log in the default BIOS setting, and all overclock settings will be re-configured.

**E. Integrated Flash Program (I.F.P.):**

IFP is a safe and quick way to upgrade BIOS.

**Step 1:**

Go to Biostar website (<http://www.biostar.com.tw>) to download the latest BIOS file. Then, save the file into a floppy disk.

**Step 2:**

Insert the floppy disk and reboot the system to get into CMOS screen.

**Step 3:**

Select the item "Integrated Flash Program" to get the following frame and choose the BIOS file downloaded in step 1.

**Step 4:**

Press "Enter" key to start BIOS file loading, and BIOS updating will process automatically.

**Step 5:**

When the BIOS update is completed, press YES to the message "Flash done, Reset system", and the system will reboot automatically to finish the process.

**Advise:**

You can update the system BIOS by simply pressing "Enter" key for three times.

**F. Smart Fan Function:**

Smart Fan Function is under “PC Health Status”.

This is a brilliant feature to control CPU Temperature vs. Fan speed.

When enabling Smart Fan function, Fan speed is controlled automatically by CPU temperature.

This function will protect CPU from overheat problem and maintain the system temperature at a safe level.



**CPU Fan Off <°C>:**

If the CPU temperature is lower than the set value, the CPU fan will turn off. The range is from 0°C~127°C, with an interval of 1°C.

**Choices: 16°C (default).**

**CPU Fan Start <°C>**

The CPU fan starts to work when CPU temperature arrives to this set value. The range is from 0°C~127°C, with an interval of 1°C.

**Choices: 32°C (default).**

**CPU Fan Full speed <°C>**

When CPU temperature arrives to the set value, the CPU fan will work under Full Speed. The range is from 0°C~127°C, with an interval of 1°C.

**Choices: 52°C (default).**

**Start PWM Value**

When CPU temperature arrives to the set value, the CPU fan will work under Smart Fan Function mode. The range is from 0~127, with an interval of 1.

**Choices:** 32 (default).

**Slope PWM**

**Choices:** 1 PWM/°C (default), 2 PWM/°C, 4 PWM/°C, 8 PWM/°C, 16 PWM/°C, 32 PWM/°C, 64PWM/°C.

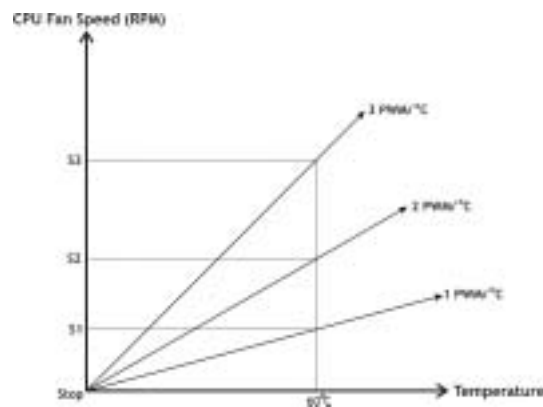

**S1:** CPU temperature is 60°C, and PWM value is 1 PWM/°C.

**S2:** CPU temperature is 60°C, and PWM value is 2 PWM/°C.

**S3:** CPU temperature is 60°C, and PWM value is 3 PWM/°C.

Increasing the value of slope PWM will raise the speed of CPU fan.

As in above diagram, when the CPU temperature reaches 60°C, the CPU fan speed for 3 PWM/°C is higher than 1 PWM/°C ( $S1 < S2 < S3$ ).

## 5.3 T-POWER WINDOWS FEATURE

### A. Hardware Monitor:

T-Power Hardware monitor allows users to monitor system voltage, temperature and fan speed accordingly.

Additionally, a rescue action will be taken by the program automatically while the system faces an abnormal condition. The program will trigger an alarm or shut down the system when unpredictable errors occur. All the monitoring items are illustrated by a waveform diagram.



### Hardware Monitor Toolbar



#### i. Start-up Setting

Click on this item to run Hardware Monitor Program when the Windows starts-up.

#### ii. Dialogue-Box Setting

Click on this item to pop-up warning dialogue-box when PC system is abnormal.

#### iii. Exit

Click on this item to exit Hardware Monitor Program.

#### iv. Hide

Click on this item to hide this program in system tray. When hiding the program, there will be a check icon in the system tray.



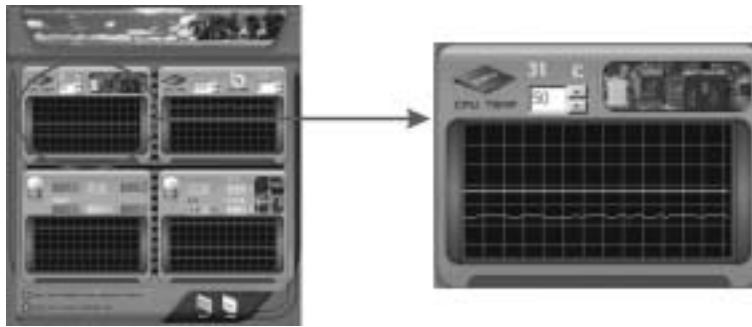

### CPU Temperature

This column configures the CPU temperature. There is a waveform to represent the status of CPU temperature.





By adjusting , users can easily configure the upper limit of CPU temperature for system operating.

In this diagram, the white line represents the upper limit which user-set for CPU temperature and the green line shows present CPU temperature.

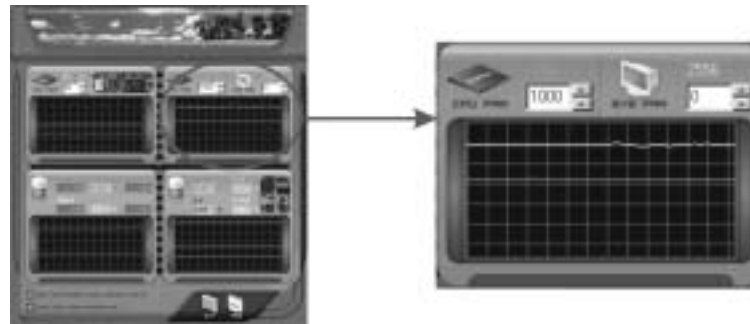

If the CPU temperature is higher than the upper limit, the status line color will change from green to red, and a warning sound will alert you. Also, the system tray icon  would change to .

### FAN Speed



By adjusting , users can easily configure the lower limit of the fan speed.

In this diagram, the green line shows present CPU Fan speed, and the yellow line shows System Fan speed (if any).

If any one of the fans speeds is lower than the set value, the status line will change into a red warning line, and the program will trigger an alarm system automatically. Also, the system tray icon  would change to .

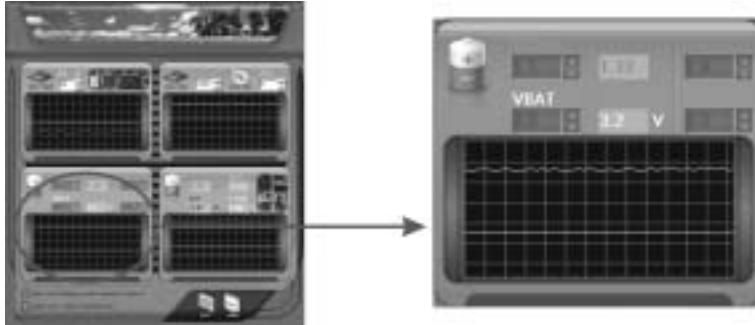

### CPU/Battery Voltage



**i. VCore**

This item displays the CPU voltage, represented by a light blue line.



Users can set the upper and lower limit by adjusting  to monitor the CPU operating voltage.

If CPU voltage is higher or lower than the set value, the status line will change into a red warning line, and a warning sound will alert you. Also, the system tray icon  will change to .

**ii. VBAT**

This item displays the CMOS battery voltage, represented by a light green line.

Users can set the upper and lower limit by adjusting  to monitor the status of battery voltage.

If battery voltage is higher or lower than the set value, the status line will change to a red warning line, and a warning sound will alert you. Also, the system tray icon  will change to .

### Reference data

This column represents the status of power supply voltage and cannot be adjusted, it is only for present status reference.

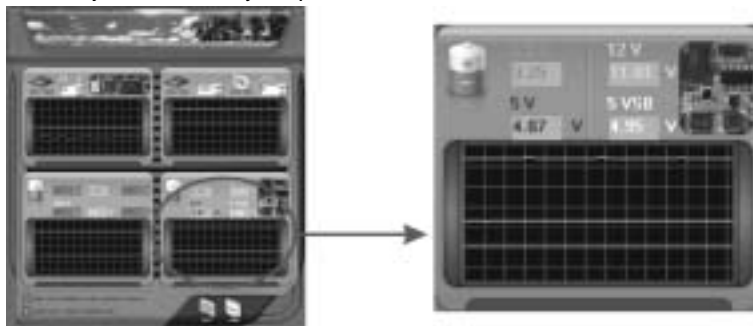

## B. Overclocking Configurations

This diagram is designed for T-series Overclocking utility. Friendly interface and solid overclock features are the major concept of this utility.

Graphic 1 will appear when activating this utility.



Graphic 1

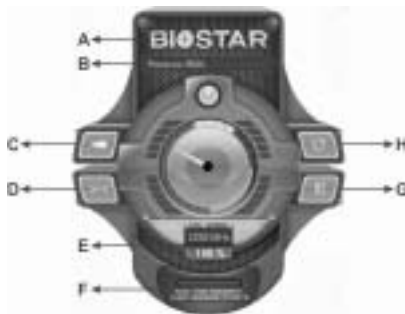

Graphic 2

- A. Clicking on "Biostar" will lead you to the Biostar Homepage.
- B. This column shows the CPU speed information.
- C. Click on this button and the utility will pop-up 4 sub-screens (Please refers to Graphic 3).
- D. Click on this button to minimize this program to taskbar.
- E. This column shows present CPU speed and overclocking percentage.
- F. Clicking on this button will make the program start up as soon as the Windows starts up.
- G. Click on this button to exit this overclock utility.
- H. Click on this button to reset all the overclock features to default setting.

By adjusting the overclocking features in 4 sub-screens, users can tune the system performance to an optimal level.



Graphic 3

### CPU Overclocking Settings:



By adjusting  can configure three items for CPU overclocking.

**A. CPU Frequency**

Range: 200MHz~450MHz.  
Interval: 1MHz.

**B. CPU Ratio**

Range: 4~25.  
Interval: 1.

**C. CPU Voltage**

Range: 0.8V~2.0V.  
Interval: 0.0125V.

### Memory Overclocking Settings:



By adjusting  can configure two items for Memory overclocking.

**A. Memory Clock Frequency**

Choices: 100, 133, 200, 266, 333, 400, 533, 667, 800.

**B. Memory Voltage**

Range: 1.8V~2.8V.  
Interval: 0.1V.

### AGP/PCI-Express Overclocking Setting:



By adjusting  can configure VGA card overclocking. And this function helps to increase VGA card performance.

Range: 100MHz~150MHz.

Interval: 1MHz.



**PCI Overclocking Setting:**



This diagram shows present PCI working status and helps to monitor PCI peripherals working status.

This item cannot be adjusted.

### C. Smart Fan Function



When Smart Fan Function is activated, screens will pop-up to illustrate the fan speed information.

**i. CPU Temperature:**

Show current CPU temperature.

**ii. CPU Fan speed:**

Show current CPU Fan speed.

**iii. System Fan speed:**

Show current system Fan speed.

**iv. Calibrate:**

When changing CPU Fan or System Fan, click on this button to re-calibrate the Fan speed.



**Note:**

1. When Smart Fan Function activates for the first time, this calibrate function would auto-run to get upper and lower limitation of CPU Fan and System Fan.
2. When calibrating process is done, the calibrating window will auto-close, and the main screen will show new fan speed data.



**v. Auto:**

If the green indicator is lit up, the Smart Fan Function is "On" (Default Setting).

Click on this button again to close Smart Fan Function, and a screen as below would pop-up.

There will be pulling-meter besides the CPU Fan and System Fan, the CPU Fan and the System Fan speed can be adjusted by adjusting the Cursor Up or Down.

**vi. Program Tool Bar:**

-  **About:**  
Click on this button to get program-related information.
-  **Minimize:**  
Click on this button to minimize the program to system tray
-  **Exit:**  
Click on this button to exit this program.

### D. Live Update



When Live Update program is activated, a screen will pop up to illustrate BIOS related information.

**i. Link to Internet:**

Click on this button will link to Biostar website and BIOS file will be downloaded.

**ii. Update BIOS:**

Click on this button to run BIOS flashing process, and it's easy and safe.

**iii. Backup BIOS:**

Click on this button, and BIOS file will be saved into the user-selected folder.

**iv. Clear CMOS:**

Click on this item will clear the CMOS Data. When carrying this job, the previous CMOS data would be cleared and returned to default setting.

## **CHAPTER 6: USEFUL HELP**

### **6.1 DRIVER INSTALLATION NOTE**

After you installed your operating system, please insert the Fully Setup Driver CD into your optical drive and install the driver for better system performance.

You will see the following window after you insert the CD



The setup guide will auto detect your motherboard and operating system.

**Note:**

If this window didn't show up after you insert the Driver CD, please use file browser to locate and execute the file **SETUP.EXE** under your optical drive.

#### **A. Driver Installation**

To install the driver, please click on the Driver icon. The setup guide will list the compatible driver for your motherboard and operating system. Click on each device driver to launch the installation program.

#### **B. Software Installation**

To install the software, please click on the Software icon. The setup guide will list the software available for your system, click on each software title to launch the installation program.

#### **C. Manual**

Aside from the paperback manual, we also provide manual in the Driver CD. Click on the Manual icon to browse for available manual.

**Note:**

You will need Acrobat Reader to open the manual file. Please download the latest version of Acrobat Reader software from

<http://www.adobe.com/products/acrobat/readstep2.html>

## 6.2 AWARD BIOS BEEP CODE

Beep Sound	Meaning
One long beep followed by two short beeps	Video card not found or video card memory bad
High-low siren sound	CPU overheated System will shut down automatically
One Short beep when system boot-up	No error found during POST
Long beeps every other second	No DRAM detected or install

## 6.3 EXTRA INFORMATION

### A. BIOS Update

After you fail to update BIOS or BIOS is invaded by virus, the Boot-Block function will help to restore BIOS. If the following message is shown after boot-up the system, it means the BIOS contents are corrupted.

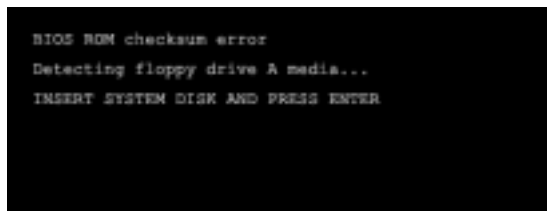

In this Case, please follow the procedure below to restore the BIOS:

1. Make a bootable floppy disk.
2. Download the Flash Utility "AWDFLASH.exe" from the Biostar website: [www.biostar.com.tw](http://www.biostar.com.tw)
3. Confirm motherboard model and download the respectively BIOS from Biostar website.
4. Copy "AWDFLASH.exe" and respectively BIOS into floppy disk.
5. Insert the bootable disk into floppy drive and press Enter.
6. System will boot-up to DOS prompt.
7. Type "*Awdflash xxxx.bf/sn/py/r*" in DOS prompt.  
(xxxx means BIOS name.)
8. System will update BIOS automatically and restart.
9. The BIOS has been recovered and will work properly.

### **B. CPU Overheated**

If the system shutdown automatically after power on system for seconds, that means the CPU protection function has been activated.

When the CPU is over heated, the motherboard will shutdown automatically to avoid a damage of the CPU, and the system may not power on again.

In this case, please double check:

1. The CPU cooler surface is placed evenly with the CPU surface.
2. CPU fan is rotated normally.
3. CPU fan speed is fulfilling with the CPU speed.

After confirmed, please follow steps below to relief the CPU protection function.

1. Remove the power cord from power supply for seconds.
2. Wait for seconds.
3. Plug in the power cord and boot up the system.

Or you can:

1. Clear the CMOS data.  
(See "Close CMOS Header: JCMOS1" section)
2. Wait for seconds.
3. Power on the system again.

## 6.4 TROUBLESHOOTING

Probable	Solution
1. No power to the system at all Power light don't illuminate, fan inside power supply does not turn on. 2. Indicator light on keyboard does not turn on.	1. Make sure power cable is securely plugged in. 2. Replace cable. 3. Contact technical support.
System inoperative. Keyboard lights are on, power indicator lights are lit, and hard drive is spinning.	Using even pressure on both ends of the DIMM, press down firmly until the module snaps into place.
System does not boot from hard disk drive, can be booted from optical drive.	1. Check cable running from disk to disk controller board. Make sure both ends are securely plugged in; check the drive type in the standard CMOS setup. 2. Backing up the hard drive is extremely important. All hard disks are capable of breaking down at any time.
System only boots from optical drive. Hard disk can be read and applications can be used but booting from hard disk is impossible.	1. Back up data and applications files. 2. Reformat the hard drive. Re-install applications and data using backup disks.
Screen message says "Invalid Configuration" or "CMOS Failure."	Review system's equipment. Make sure correct information is in setup.
Cannot boot system after installing second hard drive.	1. Set master/slave jumpers correctly. 2. Run SETUP program and select correct drive types. Call the drive manufacturers for compatibility with other drives.



This page is intentionally left blank

**APPENDENCIES: SPEC IN OTHER LANGUAGE****GERMAN**

Spezifikationen		
CPU	Socket AM2 AMD Athlon 64 / Athlon 64 FX / Athlon 64 x2/ Sempron Prozessoren	Die AMD 64-Architektur unterstützt eine 32-Bit- und 64-Bit-Datenverarbeitung Unterstützt Hyper Transport und Cool'n'Quiet
FSB	Unterstützt HyperTransport mit einer Bandbreite von bis zu 1 GHz	
Chipsatz	nForce 570 Ultra	
Super E/A	ITE 8716F Bietet die häufig verwendeten alten Super E/A-Funktionen. Low Pin Count-Schnittstelle	Umgebungskontrolle, Hardware-Überwachung Lüfterdrehzahl-Controller "Smart Guardian"-Funktion von ITE
Arbeitsspeicher	DDR2 DIMM-Steckplätze x 4 Jeder DIMM unterstützt 256/512MB & 1GB DDR2. Max. 4GB Arbeitsspeicher	Dual-Kanal DDR2 Speichermodul Unterstützt DDR2 533 / 667 / 800 registrierte DIMMs. ECC DIMMs werden nicht unterstützt.
IDE	Integrierter IDE-Controller Ultra DMA 33 / 66 / 100 / 133 Bus Master-Modus	Unterstützt PIO-Modus 0~4,
SATA II	Integrierter Serial ATA-Controller Datenferrate bis zu 3Gb/s	Konform mit der SATA-Spezifikation Version 2.0.
LAN	Marvell 88E1116 PHY 10 / 100 Mb/s und 1Gb/s	Auto-Negotiation Halb-/ Vollduplex-Funktion
Audio-Codec	Realtek ALC888	8-Kanal-Audioausgabe
1394a	VIA VT 6307 / VT 6308	Unterstützt IEEE 1394a mit einer Ferrate von bis zu 400 Mbps
Steckplätze	PCI-Steckplatz x3 PCI Express x16 Steckplatz x1 PCI Express x 1-Steckplatz x3	
Onboard-Anschluss	Diskettenlaufwerkanschluss x1 Druckeranschluss Anschluss x1	Jeder Anschluss unterstützt 2 Diskettenlaufwerke Jeder Anschluss unterstützt 1 Druckeranschluss

Spezifikationen			
	IDE-Anschluss	x1	Jeder Anschluss unterstützt 2 IDE-Laufwerke
	SATA-Anschluss	x6	Jeder Anschluss unterstützt 1 SATA-Laufwerk
	Fronttafelanschluss	x1	Unterstützt die FronttafelFunktionen
	Front-Audioanschluss	x1	Unterstützt die Fronttafel-Audioanschlussfunktion
	CD-IN-Anschluss	x1	Unterstützt die CD Audio-In-Funktion
	S/PDIF- Ausgangsanschluss	x1	Unterstützt die digitale Audioausgabefunktion
	S/PDIF Eingangsanschluss	x1	Unterstützt die digitale Audioeingabefunktion
	CPU-Lüfter-Sockel	x1	CPU-Lüfterstromversorgungsanschluss (mit Smart Fan-Funktion)
	System-Lüfter-Sockel	x3	System-Lüfter-Stromversorgungsanschluss
	"Gehäuse offen"-Sockel(optional)	x1	Zur Erkennung eines geöffneten Gehäuses
	"CMOS löschen"-Sockel	x1	
	USB-Anschluss	x2	Jeder Anschluss unterstützt 2 Fronttafel-USB-Anschlüsse
	Stromanschluss (24-polig)	x1	
	Stromanschluss (8-polig)	x1	
Rückseiten-E/A	PS/2-Tastatur	x1	
	PS/2-Maus	x1	
	Serieller Anschluss	x1	
	LAN-Anschluss	x1	
	USB-Anschluss	x6	
	Audioanschluss	x6	
Platinengröße	244 mm (B) X 305 mm (L)		
Sonderfunktionen	NVIDIA nTunes Unterstützt RAID 0 / 1 / 0+1 / 5		
OS-Unterstützung	Windows 2000 / XP		Biostar behält sich das Recht vor, ohne Ankündigung die Unterstützung für ein Betriebssystem hinzuzufügen oder zu entfernen.

**FRANCE**

SPEC		
UC	Socket AM2 Processeurs AMD Athlon 64 / Athlon 64 FX / Athlon 64 x2/ Sempron	L'architecture AMD 64 permet le calcul 32 et 64 bits Prend en charge Hyper Transport et Cool'n'Quiet
Bus frontal	Prend en charge Hyper Transport jusqu'à une bande passante de 1 GHz	
Chipset	nForce 570 Ultra	
Super E/S	ITE 8716F Fournit la fonctionnalité de Super E/S patrimoniales la plus utilisée. Interface à faible compte de broches	Initiatives de contrôle environnementales, Moniteur de matériel Contrôleur de vitesse de ventilateur Fonction "Gardien intelligent" de l'ITE
Mémoire principale	Fentes DDR2 DIMM x 4 Chaque DIMM prend en charge des DDR2 de 256/512 Mo et 1Go Capacité mémoire maximale de 4 Go	Module de mémoire DDR2 à mode à double voie Prend en charge la DDR2 533 / 667 / 800 Les DIMM à registres et DIMM sans code correcteurs d'erreurs ne sont pas prises en charge
IDE	Contrôleur IDE intégré Mode principale de Bus Ultra DMA 33 / 66 / 100 / 133	Prend en charge le mode PIO 0~4,
SATA SATA II	Contrôleur Serial ATA intégré : Taux de transfert jusqu'à 3 Go/s.	Conforme à la spécification SATA Version 2.0
LAN	Marvell 88E1116 PHY	10 / 100 Mb/s et 1 Gb/s négociation automatique Half / Full duplex capability
Codec audio	Realtek ALC888 Sortie audio à 8 voies	AC'97 Version 2.3 Sortie S/PDIF
Fentes	Fente PCI x3 Slot PCI Express x16 x1 Slot PCI Express x 1 x3	
Connecteur embarqué	Connecteur de disquette x1 Connecteur de Port d'imprimante x1 Connecteur IDE x1	Chaque connector prend en charge 2 lecteurs de disquettes Chaque connector prend en charge 1 Port d'imprimante Chaque connecteur prend en charge 2 périphériques IDE

SPEC			
	Connecteur SATA	x6	Chaque connecteur prend en charge 1 périphérique SATA
	Connecteur du panneau avant	x1	Prend en charge les équipements du panneau avant
	Connecteur Audio du panneau avant	x1	Prend en charge la fonction audio du panneau avant
	Connecteur d'entrée CD	x1	Prend en charge la fonction d'entrée audio de CD
	Connecteur de sortie S/PDIF	x1	Prend en charge la fonction de sortie audio numérique
	Connecteur d'entrée S/PDIF	x1	Prend en charge la fonction d'entrée audio numérique
	Embase de ventilateur UC	x1	Alimentation électrique du ventilateur UC (avec fonction de ventilateur intelligent)
	Embase de ventilateur système	x3	Alimentation électrique du ventilateur système
	Embase d'ouverture de châssis (en option)	x1	Pour la fonction de détection d'intrus dans le châssis
	Embase d'effacement CMOS	x1	
	Connecteur USB	x2	Chaque connecteur prend en charge 2 ports USB de panneau avant
	Connecteur d'alimentation (24 broches)	x1	
	Connecteur d'alimentation (8 broches)	x1	
E/S du panneau arrière	Clavier PS/2	x1	
	Souris PS/2	x1	
	Port série	x1	
	Port LAN	x1	
	Port USB	x6	
	Fiche audio	x6	
Dimensions de la carte	244 mm (l) X 305 mm (H)		
Fonctionnalités spéciales	NVIDIA nTunes Prise en charge RAID 0 / 1 / 0+1 / 5		
Support SE	Windows 2000 / XP		Biostar se réserve le droit d'ajouter ou de supprimer le support de SE avec ou sans préavis.

**ITALIAN**

SPECIFICA		
CPU	Socket AM2 Processori AMD Athlon 64 / Athlon 64 FX / Athlon 64 x2/ Sempron	L'architettura AMD 64 abilita la computazione 32 e 64 bit Supporto di Hyper Transport e Cool'n'Quiet
FSB	Supporto di HyperTransport fino a 1 GHz di larghezza di banda	
Chipset	nForce 570 Ultra	
Super I/O	ITE 8716F Fornisce le funzionalità legacy Super I/O usate più comunemente. Interfaccia LPC (Low Pin Count)	Funzioni di controllo dell'ambiente: Monitoraggio hardware Controller velocità ventolina Funzione "Smart Guardian" di ITE
Memoria principale	Alloggi DIMM DDR2 x 4 Ciascun DIMM supporta DDR2 256/512MB e 1GB Capacità massima della memoria 4GB	Modulo di memoria DDR2 a canale doppio Supporto di DDR2 533 / 667 / 800 DIMM registrati e DIMM ECC sono supportati
IDE	Controller IDE integrato Modalità Bus Master Ultra DMA 33 / 66 / 100 / 133	Supporto modalità PIO Mode 0-4
SATA II	Controller Serial ATA integrato Velocità di trasferimento dei dati fino a 3 Gb/s.	Compatibile specifiche SATA Versione 2.0.
LAN	Marvell 88E1116 PHY	Negoziazione automatica 10 / 100 Mb/s e 1Gb/s Capacità Half / Full Duplex
Codec audio	Realtek ALC888	Uscita audio 8 canali
Alloggi	Alloggio PCI x3 Alloggio PCI Express x16 x1 Alloggio PCI Express x1 x3	
Connettori su scheda	Connettore floppy x1 Connettore Porta stampante x1 Connettore IDE x1 Connettore SATA x6	Ciascun connettore supporta 2 unità Floppy Ciascun connettore supporta 1 Porta stampante Ciascun connettore supporta 2 unità IDE Ciascun connettore supporta 1 unità SATA

SPECIFICA			
	Connettore pannello frontale	x1	Supporta i servizi del pannello frontale
	Connettore audio frontale	x1	Supporta la funzione audio pannello frontale
	Connettore CD-in	x1	Supporta la funzione input audio CD
	Connettore output SPDIF	x1	Supporta la funzione d'output audio digitale
	Connettore input S/PDIF	x1	Supporta la funzione d'input audio digitale
	Collettore ventolina CPU	x1	Alimentazione ventolina CPU (con funzione Smart Fan)
	Collettore ventolina sistema	x3	Alimentazione ventolina di sistema
	Collettore apertura telaio (optional)	x1	Per la funzione di rilevamento intrusione telaio
	Collettore cancellazione CMOS	x1	
	Connettore USB	x2	Ciascun connettore supporta 2 porte USB pannello frontale
	Connettore alimentazione (24 pin)	x1	
	Connettore alimentazione (8 pin)	x1	
I/O pannello posteriore	Tastiera PS/2	x1	
	Mouse PS/2	x1	
	Porta seriale	x1	
	Porta LAN	x1	
	Porta USB	x6	
	Connettore audio	x6	
Dimensioni scheda	244 mm (larghezza) x 305 mm (altezza)		
Caratteristiche speciali	nTunes NVIDIA Supporto RAID 0 / 1 / 0+1 / 5		
Sistemi operativi supportati	Windows 2000 / XP		Biostar si riserva il diritto di aggiungere o rimuovere il supporto di qualsiasi sistema operativo senza preavviso.

**SPANISH**

Especificación		
CPU	Conector AM2 Procesadores AMD Athlon 64 / Athlon 64 FX / Athlon 64 x2/ Sempron	La arquitectura AMD 64 permite el procesado de 32 y 64 bits Soporta las tecnologías Hyper Transport y Cool'n'Quiet
FSB	Admite HyperTransport con un ancho de banda de hasta 1 GHz	
Conjunto de chips	nForce 570 Ultra	
Súper E/S	ITE 8716F Le ofrece las funcionalidades heredadas de uso más común Súper E/S. Interfaz de cuenta Low Pin	Iniciativas de control de entorno, Monitor hardware Controlador de velocidad de ventilador Función "Guardia inteligente" de ITE
Memoria principal	Ranuras DIMM DDR2 x 4 Cada DIMM admite DDR de 256/512MB y 1GB Capacidad máxima de memoria de 4GB	Módulo de memoria DDR2 de canal Doble Admite DDR2 de 533 / 667 / 800 No admite DIMM registrados o DIMM no compatibles con ECC
IDE	Controlador IDE integrado Modo bus maestro Ultra DMA 33 / 66 / 100 / 133	Soporte los Modos PIO 0~4,
SATA II	Controlador ATA Serie Integrado Tasas de transferencia de hasta 3 Gb/s.	Compatible con la versión SATA 2.0.
Red Local	Marvell 88E1116 PHY	Negociación de 10 / 100 Mb/s y 1 Gb/s Funciones Half / Full dúplex
Códecs de sonido	Realtek ALC888	Salida de sonido de 8 canales
Ranuras	Ranura PCI X3 Ranura PCI Express x16 X1 Ranura PCI express x 1 X3	
Conectores en placa	Conector disco flexible X1 Conector Puerto de impresora X1 Conector IDE X1 Conector SATA X6	Cada conector soporta 2 unidades de disco flexible Cada conector soporta 1 Puerto de impresora Cada conector soporta 2 dispositivos IDE Cada conector soporta 1 dispositivos SATA



Especificación			
	Conector de panel frontal	X1	Soporta instalaciones en el panel frontal
	Conector de sonido frontal	X1	Soporta funciones de sonido en el panel frontal
	Conector de entrada de CD	X1	Soporta función de entrada de sonido de CD
	Conector de salida S/PDIF	X1	Soporta función de salida de sonido digital
	Cabecera de ventilador de CPU	X1	Fuente de alimentación de ventilador de CPU (con función Smart Fan)
	Cabecera de ventilador de sistema	X3	Fuente de alimentación de ventilador de sistema
	Cabecera de chasis abierto(opcional)	X1	Función de detección de intrusos en el chasis
	Cabecera de borrado de CMOS	X1	
	Conector USB	X2	Cada conector soporta 2 puertos USB frontales
	Conector de alimentación (24 patillas)	X1	
	Conector de alimentación (8 patillas)	X1	
Panel trasero de E/S	Teclado PS/2	X1	
	Ratón PS/2	X1	
	Puerto serie	X1	
	Puerto de red local	X1	
	Puerto USB	X6	
	Conector de sonido	X6	
Tamaño de la placa	244 mm. (A) X 305 Mm. (H)		
Funciones especiales	NVIDIA nTunes Admite RAID 0 / 1 / 0+1 / 5		
Soporte de sistema operativo	Windows 2000 / XP		Biostar se reserva el derecho de añadir o retirar el soporte de cualquier SO con o sin aviso previo.

**PORTUGUESE**

ESPECIFICAÇÕES		
CPU	Socket AM2 Processadores AMD Athlon 64 / Athlon 64 FX / Athlon 64 x2/ Sempron	A arquitectura AMD 64 permite uma computação de 32 e 64 bits Suporta as tecnologias Hyper Transport e Cool'n'Quiet
FSB	Suporta a tecnologia HyperTransport com uma largura de banda até 1 GHz	
Chipset	nForce 570 Ultra	
Especificação do Super I/O	ITE 8716F Proporciona as funcionalidades mais utilizadas em termos da especificação Super I/O. Interface LPC (Low Pin Count).	Iniciativas para controlo do ambiente Monitorização do hardware Controlador da velocidade da ventoinha Função "Smart Guardian" da ITE
Memória principal	Ranuras DIMM DDR2 x 4 Cada módulo DIMM suporta uma memória DDR2 de 256/512 MB & 1 GB Capacidade máxima de memória: 4 GB	Módulo de memória DDR2 de canal duplo Suporta módulos DDR2 533 / 667 / 800 Os módulos DIMM registados e os DIMM ECC são suportados
IDE	Controlador IDE integrado Modo Bus master Ultra DMA 33 / 66 / 100 / 133	Suporta o modo PIO 0~4,
SATA II	Controlador Serial ATA integrado Velocidades de transmissão de dados até 3 Gb/s.	Compatibilidade com a especificação SATA versão 2.0.
LAN	Marvell 88E1116 PHY	Auto negociação de 10 / 100 Mb/s e 1Gb/s Capacidade semi/full-duplex
Codec de som	Realtek ALC 888	Saída de áudio de 8 canais
Ranuras	Ranhura PCI x3 Ranhura PCI Express x16 x1 Ranhura PCI Express x 1 x3	
Conectores na placa	Conector da unidade de disquetes x1 Conector da para impressora x1	Cada conector suporta 2 unidades de disquetes Cada conector suporta 1 Porta para impressora

ESPECIFICAÇÕES			
	Conector IDE	x1	Cada conector suporta 2 dispositivos IDE
	Conector SATA	x6	Cada conector suporta 1 dispositivo SATA
	Conector do painel frontal	x1	Para suporte de várias funções no painel frontal
	Conector de áudio frontal	x1	Suporta a função de áudio no painel frontal
	Conector para entrada de CDs	x1	Suporta a entrada de áudio a partir de CDs
	Conector de saída S/PDIF	x1	Suporta a saída de áudio digital
	Conector de entrada S/PDIF	x1	Suporta a entrada de áudio digital
	Conector da ventoinha da CPU	x1	Alimentação da ventoinha da CPU (com a função Smart Fan)
	Conector da ventoinha do sistema	x3	Alimentação da ventoinha do sistema
	Conector para detecção da abertura do chassis (opcional)	x1	Para detectar qualquer intrusão no chassis
	Conector para limpeza do CMOS	x1	
	Conector USB	x2	Cada conector suporta 2 portas USB no painel frontal
	Conector de alimentação (24 pinos)	x1	
	Conector de alimentação (8 pinos)	x1	
Entradas/Saídas no painel traseiro	Teclado PS/2	x1	
	Rato PS/2	x1	
	Porta série	x1	
	Porta LAN	x1	
	Porta USB	x6	
	Tomada de áudio	x6	
Tamanho da placa	244 mm (L) X 305 mm (A)		
Características especiais	nTunes da NVIDIA Suporta as funções RAID 0 / 1 / 0+1 / 5		
Sistemas operativos suportados	Windows 2000 / XP		A Biostar reserva-se o direito de adicionar ou remover suporte para qualquer sistema operativo com ou sem aviso prévio.

**POLISH**

SPEC		
Procesor	Socket AM2 AMD Athlon 64 / Athlon 64 FX / Athlon 64 x2/ Sempron Procesory	Architektura AMD 64 umożliwia przetwarzanie 32 i 64 bitowe Obsługa Hyper Transport oraz Cool'n'Quiet
FSB	Obsługa HyperTransport o szerokości pasma do 1 GHz	
Chipset	nForce 570 Ultra	
Pamięć główna	Gniazda DDR2 DIMM x 4 Każde gniazdo DIMM obsługuje moduły 256/512MB oraz 1GB DDR2 Maks. wielkość pamięci 4GB	Moduł pamięci DDR2 z trybem podwójnego kanału Obsługa DDR2 533 / 667 / 800 Brak obsługi Registered DIMM oraz ECC DIMM
Super I/O	ITE 8716F Zapewnia najbardziej powszechne funkcje Super I/O. Interfejs Low Pin Count	Funkcje kontroli warunków pracy, Monitor H/W Kontroler prędkości wentylatora Funkcja ITE "Smart Guardian"
IDE	Zintegrowany kontroler IDE Ultra DMA 33 / 66 / 100 / 133 Tryb Bus Master	obsługa PIO tryb 0~4,
SATA II	Zintegrowany kontroler Serial ATA Transfer danych do 3 Gb/s.	Zgodność ze specyfikacją SATA w wersji 2.0.
LAN	Marvell 88E1116 PHY	10 / 100 Mb/s oraz 1Gb/s z automatyczną negocjacją szybkości Działanie w trybie półwicznego / pełnego duplexu
Kodek dźwiękowy	Realtek ALC 888	8 kanałowe wyjście audio
Gniazda	Gniazdo PCI x3 Gniazdo PCI Express x16 x1 Gniazdo PCI Express x 1 x3	
Złącza wbudowane	Złącze napędu dyskiety x1 Złącze Port drukarki x1 Złącze IDE x1 Złącze SATA x6	Każde złącze obsługuje 2 napędy dyskiety Każde złącze obsługuje 1 Port drukarki Każde złącze obsługuje 2 urządzenia IDE Każde złącze obsługuje 1 urządzenie SATA

SPEC			
	Złącze panela przedniego	x1	Obsługa elementów panela przedniego
	Przednie złącze audio	x1	Obsługa funkcji audio na panelu przednim
	Złącze wejścia CD	x1	Obsługa funkcji wejścia audio CD
	Złącze wyjścia S/PDIF	x1	Obsługa funkcji cyfrowego wyjścia audio
	Złącze wejścia S/PDIF	x1	Obsługa funkcji cyfrowego wejścia audio
	Złącze główkowe wentylatora procesora	x1	Zasilanie wentylatora procesora (z funkcją Smart Fan)
	Złącze główkowe wentylatora systemowego	x3	Zasilanie wentylatora systemowego
	Złącze główkowe otwarcia obudowy (opcja)	x1	Do funkcji wykrywania naruszenia obudowy
	Złącze główkowe kasowania CMOS	x1	
	Złącze USB	x2	Każde złącze obsługuje 2 porty USB na panelu przednim
	Złącze zasilania (24 pinowe)	x1	
	Złącze zasilania (8 pinowe)	x1	
Back Panel I/O	Klawiatura PS/2	x1	
	Mysz PS/2	x1	
	Port szeregowy	x1	
	Port LAN	x1	
	Port USB	x6	
	Gniazdo audio	x6	
Wymiary płyty	244 mm (S) X 305 mm (W)		
Funkcje specjalne	NVIDIA nTunes. Obsługa RAID 0 / 1 / 0+1 / 5		
Obsługa systemu operacyjnego	Windows 2000 / XP		Biostar zastrzega sobie prawo dodawania lub odwoływania obsługi dowolnego systemu operacyjnego bez powiadomienia.

**RUSSIAN**

СПЕЦ.		
CPU (центральный процессор)	Гнездо AM2 Процессоры AMD Athlon 64 / Athlon 64 FX / Athlon 64X2	Архитектура AMD 64 разрешать обработка данных на 32 и 64 бит Поддержка Hyper Transport и Cool'n'Quiet
FSB	Поддержка HyperTransport с пропускной способностью до 1 ГГц	
Набор микросхем	nForce 570 Ultra	
Основная память	Слоты DDR2 DIMM x 4 Каждый модуль DIMM поддерживает 256/512 МБ & 1 ГБ DDR2 Максимальная ёмкость памяти 4 ГБ	Модуль памяти с двухканальным режимом DDR2 Поддержка DDR2 533 / 667 / 800 Не поддерживает зарегистрированные модули DIMM and ECC DIMM
Super I/O	ITE 8716F Обеспечивает наиболее используемые действующие функциональные возможности Super I/O. Интерфейс с низким количеством выводов	Инициативы по охране окружающей среды, Аппаратный монитор Регулятор скорости Функция ITE "Smart Guardian" (Интеллектуальная защита)
IDE	Встроенное устройство управления встроенными интерфейсами устройств	Режим "хозяина" шины Ultra DMA 33 / 66 / 100 / 133 Поддержка режима PIO 0~4,
SATA II	Встроенное последовательное устройство управления ATA	скорость передачи данных до 3 гигабит/с. Соответствие спецификации SATA версия 2.0.
Локальная сеть	Marvell 88E1116 PHY	Автоматическое согласование 10 / 100 Мб/с и 1 Гб/с Частичная / полная дуплексная способность
Звуковой кодек	Realtek ALC 888	Восьмиканальный звуковой выход
Слоты	Слот PCI x3 Слот PCI Express x16 x1 Слот PCI Express x 1 x3	
Встроенный разъём	Разъём НГМД x1 Разъём Порт подключения принтера x1 Разъём IDE x1 Разъём SATA x6	Каждый разъём поддерживает 2 накопителя на гибких магнитных дисках Каждый разъём поддерживает 1 Порт подключения принтера Каждый разъём поддерживает 2 встроенных интерфейса накопителей Каждый разъём поддерживает 1 устройство SATA

СПЕЦ.			
	Разъём на лицевой панели	x1	Поддержка устройств на лицевой панели
	Входной звуковой разъём	x1	Поддержка звуковых функций на лицевой панели
	Разъём ввода для CD	x1	Поддержка функции ввода для CD
	Разъём вывода для S/PDIF	x1	Поддержка вывода цифровой звуковой функции
	Разъём ввода для S/PDIF	x1	Поддержка ввода цифровой звуковой функции
	Контактирующее приспособление вентилятора центрального процессора..		Источник питания для вентилятора центрального процессора (с функцией интеллектуального вентилятора)
	Контактирующее приспособление вентилятора системы	x3	Источник питания для вентилятора системы
	Шасси открытого контактирующего приспособления (дополнительно)	x1	Для функции обнаружения злоумышленника шасси
	Открытое контактирующее приспособление CMOS	x1	
	USB-разъём	x2	Каждый разъём поддерживает 2 USB-порта на лицевой панели
	Разъём питания (24 вывод)	x1	
	Разъём питания (8 вывод)	x1	
Задняя панель средств ввода-вывода	Клавиатура PS/2	x1	
	Мышь PS/2	x1	
	Последовательный порт	x1	
	Порт LAN	x1	
	USB-порт	x6	
	Гнездо для подключения наушников	x6	
Размер панели	244 мм (Ш) X 305 мм (В)		
Специальные технические характеристики	NVIDIA nTunes Поддержка RAID 0 / 1 / 0+1 / 5		
Поддержка OS	Windows 2000 / XP		Biostar сохраняет за собой право добавлять или удалять средства обеспечения для OS с или без предварительного уведомления.

## ARABIC

المواصفات		
وحدة المعالجة المركزية	AM2 مقبس AMD Athlon 64 / Athlon 64 FX / Athlon 64 x2/ Sempron	إجراء العمليات الحاسوبية بسرعة 32 و 64 بت AMD 64 يمكن تقنية Cool'n'Quiet و Hyper Transport تدعم تقنية
النقل الأمامي الجانبي	1300 تيردد يصل إلى HyperTransport تدعم تقنية تردد	
مجموعة التبريد	nForce 570 Ultra	
الذاكرة الرئيسية	قناة DDR2 DIMM عدد 4 سعة DDR2 تدعم ذاكرة من نوع DIMM تدعم كل قناة 256/512 ميجا بايت و 1 جيجا بايت سعة ذاكرة قصوى 4 جيجا بايت	مزودة لقناة DDR2 وحدة ذاكرة سعت 800 / 667 / 533 ميجا بايت DDR2 تدعم الذاكرة من نوع ECC وتلك التي لا تتوافق مع DIMM لا تدعم رقائق الذاكرة
Super I/O	ITE 8716F الأكثر استخداماً . Super I/O يوفر وظيفة Low Pin Count Interface تدعم تقنية	وسائل التحكم في البيئة: مراقب لمعرفة حالة الأجزاء مراقب في سرعة المروحة ITE من "Smart Guardian" وظيفة
منفذ IDE	متكامل IDE متحكم Ultra DMA 33 / 66 / 100 / 133 نقل تقنية وضع رئيسي	PIO Mode 0~4 دعم وضع
SATA II	متكامل Serial ATA متحكم نقل البيانات بسرعة تصل إلى 3 جيجابت/ثانية.	2.0 الإصدار SATA مطابقة لمواصفات
شبكة داخلية	Marvell 88E1116 PHY	تفاوض تلقائي 10/100 ميجا بايت / ثنائية و 1 جيجابت/ثانية إمكانية النقل المزدوج الكامل/القصفي
كوديك الصوت	Realtek ALC 888	قوات لخرج الصوت 8
التحات	قناة PCI قناة PCI Express x16 قناة PCI Express x1	عدد 3 عدد 1 عدد 3
المنفذ على سطح	منفذ محرك أقراص مرنة	عدد 1 يدعم محرك الأقراص المرنة



## TForce 570 U

المواصفات		
الوحة	منفذ طباعة	عدد 1
	منفذ IDE	عدد 1 يُدمج كل منفذ اثنين من أجهزة IDE
	منفذ SATA	عدد 6 يُدمج كل منفذ واحد من أجهزة SATA
	منفذ اللوحة الأمامية	عدد 1 يُدمج تجهيزات اللوحة الأمامية
	منفذ الصوت الأمامي	عدد 1 يُدمج وظيفة الصوت باللوحة الأمامية
	منفذ CD-IN	عدد 1 يُدمج وظيفة دخل صوت القرص المدمج
	منفذ خرج S/PDIF	عدد 1 يُدمج وظيفة خرج الصوت الرقمي
	منفذ دخل S/PDIF	عدد 1 يُدمج وظيفة دخل الصوت الرقمي
	وصلة مروحة وحدة المعالجة المركزية	عدد 1 Smart Fan (توصيل الطاقة لمروحة وحدة المعالجة (مع وظيفة توصيل الطاقة لمروحة النظام
	وصلة مروحة النظام	عدد 3
	وصلة فتح البيكل (اختياري)	عدد 1 للكشف عن اختراق البيكل
	وصلة مسح CMOS	عدد 1
	منفذ USB	عدد 2 باللوحة الأمامية USB يُدمج كل منفذ قحني
	منفذ توصيل الطاقة (24 دبوس)	عدد 1
	منفذ توصيل الطاقة (8 دبوس)	عدد 1
منفذ دخل/خرج اللوحة الخلفية	لوحة مفاتيح PS/2	عدد 1
	مؤس PS/2	عدد 1
	منفذ تناسلي	عدد 1
	منفذ شبكة اتصال محلية	عدد 1
	منافذ USB	عدد 6
	مقيس صوت	عدد 6
مزيا خاصة	NVIDIA nTunes RAID 0 / 1 / 0+1 / 5 دعم تقنية	
حجم اللوحة	244 مم (عرض) X 305 مم (ارتفاع)	
دعم أنظمة التشغيل	Windows 2000 / XP	بحقها في إضافة أو إزالة الدعم لأي نظام تشغيل بإخطار أو بدون إخطار. <b>BioStar</b> يحتفظ

## JAPANESE

仕様		
CPU	Socket AM2 AMD Athlon 64 / Athlon 64 FX / Athlon 64 x2/ Sempron プロセッサ	AMD 64アーキテクチャでは、32ビットと64ビット計算が可能です ハイパートランスポートとクールアンドクワイアットをサポートします
FSB	1.3 GHzのバンド幅までハイパートランスポートをサポートします	
チップセット	nForce 570 Ultra	
メインメモリ	DDR2 DIMMスロット x 4 各DIMMは 256/512MB & 1GB DDR2をサポート 最大メモリ容量4GB	デュアル チャンネルモードDDR2 メモリモジュール DDR2 533 / 667 / 800をサポート 登録済みDIMMとECC DIMMはサポートされません
Super I/O	ITE 8716F もともと一般に使用されるレガシーSuper I/O機能を採用しています。 低ピンカウントインターフェイス	環境コントロールイニシアチブ、 H/W モニター ファン速度コントローラ/ モニター ITEの「スマートガーディアン」機能
IDE	統合IDEコントローラ Ultra DMA 33 / 66 / 100 / 133バスマスタモード	PIO Mode 0~4のサポート、
SATA II	統合シリアルATAコントローラ 最高3 Gb/秒のデータ転送速度	SATAバージョン2.0仕様に準拠。
LAN	Marvell 88E1116 PHY	10 / 100 Mb/秒および1Gb/秒のオートネゴシエーション 半/全二重機能
サウンド Codec	Realtek ALC 888	8チャンネルオーディオアウト
スロット	PCIスロット x3 PCI Express x16スロット x1 PCI Express x 1スロット x31	
オンボードコネクタ	フロッピーコネクタ x1 プリンタポートコネクタ x1	各コネクタは2つのフロッピードライブをサポートします 各コネクタは1つのプリンタポートをサポートします

仕様			
	シリアルポートコネクタ	x1	各コネクタは1つのシリアルポートをサポートします
	IDEコネクタ	x1	各コネクタは2つのIDEデバイスをサポートします
	SATAコネクタ	x6	各コネクタは1つのSATAデバイスをサポートします
	フロントパネルコネクタ	x1	フロントパネル機能をサポートします
	フロントオーディオコネクタ	x1	フロントパネルオーディオ機能をサポートします
	CDインコネクタ	x1	CDオーディオイン機能をサポートします
	S/PDIFアウトコネクタ	x1	デジタルオーディオアウト機能をサポートします
	S/PDIFインコネクタ	x1	デジタルオーディオイン機能をサポートします
	CPUファンヘッダ	x1	CPUファン電源装置(スマートファン機能を搭載)
	システムファンヘッダ	x3	システムファン電源装置
	シャーシオープンヘッダ(オプション)	x1	シャーシ侵入検出機能
	CMOSクリアヘッダ	x1	
	USBコネクタ	x2	各コネクタは2つのフロントパネルUSBポートをサポートします
	電源コネクタ(24ピン)	x1	
	電源コネクタ(8ピン)	x1	
背面パネル I/O	PS/2キーボード	x1	
	PS/2マウス	x1	
	シリアルポート	x1	
	LANポート	x1	
	USBポート	x6	
	オーディオジャック	x6	
ボードサイズ	244 mm (幅) X 305 mm (高さ)		
特殊機能	NVIDIA nTunes		
	RAID 0 / 1 / 0+1 / 5 のサポート		
OSサポート	Windows 2000 / XP		Biostarは事前のサポートなしにOSサポートを追加または削除する権利を留保します。

2006/07/04

# ***TForce 570 U***

---

<b>BIOS Setup.....</b>	<b>1</b>
1 Main Menu .....	3
2 Standard CMOS Features .....	7
3 Advanced BIOS Features .....	9
4 Advanced Chipset Features .....	16
5 Integrated Peripherals .....	19
6 Power Management Setup .....	25
7 PnP/PCI Configurations .....	29
8 PC Health Status .....	32
9 Frequency/Voltage Control .....	35
10 CMOS Reload Program(C.R.P.) .....	41

# ***TForce 570 U***

---

## **BIOS Setup**

### **Introduction**

The purpose of this manual is to describe the settings in the Award™ BIOS Setup program on this motherboard. The Setup program allows users to modify the basic system configuration and save these settings to CMOS RAM. The power of CMOS RAM is supplied by a battery so that it retains the Setup information when the power is turned off.

Basic Input-Output System (BIOS) determines what a computer can do without accessing programs from a disk. This system controls most of the input and output devices such as keyboard, mouse, serial ports and disk drives. BIOS activates at the first stage of the booting process, loading and executing the operating system. Some additional features, such as virus and password protection or chipset fine-tuning options are also included in BIOS.

The rest of this manual will to guide you through the options and settings in BIOS Setup.

### **Plug and Play Support**

This AWARD BIOS supports the Plug and Play Version 1.0A specification and ESCD (Extended System Configuration Data) write.

### **EPA Green PC Support**

This AWARD BIOS supports Version 1.03 of the EPA Green PC specification.

### **APM Support**

This AWARD BIOS supports Version 1.1&1.2 of the Advanced Power Management (APM) specification. Power management features are implemented via the System Management Interrupt (SMI). Sleep and Suspend power management modes are supported. Power to the hard disk drives and video monitors can also be managed by this AWARD BIOS.

### **ACPI Support**

Award ACPI BIOS support Version 1.0 of Advanced Configuration and Power interface specification (ACPI). It provides ASL code for power management and device configuration capabilities as defined in the ACPI specification, developed by Microsoft, Intel and Toshiba.

# ***TForce 570 U***

---

## **PCI Bus Support**

This AWARD BIOS also supports Version 2.1 of the Intel PCI (Peripheral Component Interconnect) local bus specification.

## **DRAM Support**

DDR SDRAM (Double Data Rate Synchronous DRAM) is supported.

## **Supported CPUs**

This AWARD BIOS supports the AMD CPU.

## **Using Setup**

Use the arrow keys to highlight items in most of the place, press <Enter> to select, use the <PgUp> and <PgDn> keys to change entries, press <F1> for help and press <Esc> to quit. The following table provides more detail about how to navigate in the Setup program by using the keyboard.

<b>Keystroke</b>	<b>Function</b>
Up arrow	Move to previous item
Down arrow	Move to next item
Left arrow	Move to the item on the left (menu bar)
Right arrow	Move to the item on the right (menu bar)
Move Enter	Move to the item you desired
PgUp key	Increase the numeric value or make changes
PgDn key	Decrease the numeric value or make changes
+ Key	Increase the numeric value or make changes
- Key	Decrease the numeric value or make changes
Esc key	Main Menu – Quit and not save changes into CMOS Status Page Setup Menu and Option Page Setup Menu – Exit Current page and return to Main Menu
F1 key	General help on Setup navigation keys
F5 key	Load previous values from CMOS
F7 key	Load the optimized defaults
F10 key	Save all the CMOS changes and exit

---

# TForce 570 U

---

## 1 Main Menu

Once you enter Award BIOS™ CMOS Setup Utility, the Main Menu will appear on the screen. The Main Menu allows you to select from several setup functions. Use the arrow keys to select among the items and press <Enter> to accept and enter the sub-menu.

**!! WARNING !!**

For better system performance, the BIOS firmware is being continuously updated. The BIOS information described in this manual (**Figure 1, 2, 3, 4, 5, 6, 7, 8, 9**) is for your reference only. The actual BIOS information and settings on board may be slightly different from this manual.

■ Figure 1: Main Menu

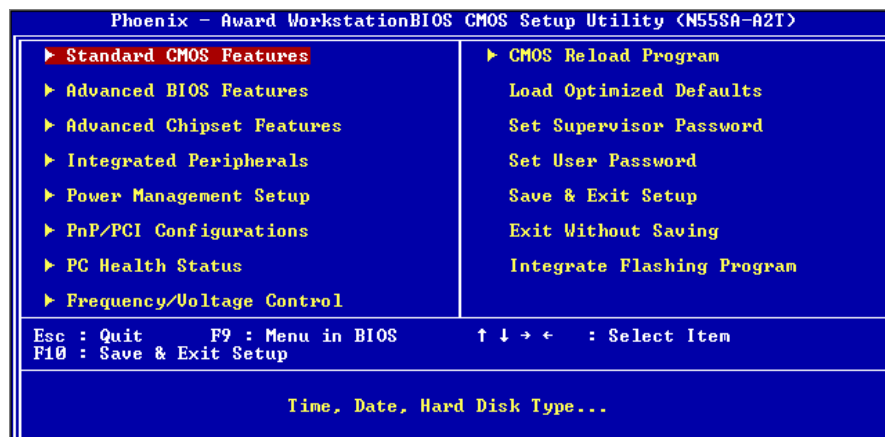

### Standard CMOS Features

This submenu contains industry standard configurable options.

### Advanced BIOS Features

This submenu allows you to configure advanced features of the BIOS.

# ***TForce 570 U***

---

## **Advanced Chipset Features**

This submenu allows you to configure special chipset features.

## **Integrated Peripherals**

This submenu allows you to configure certain IDE hard drive options and Programmed Input/ Output features.

## **Power Management Setup**

This submenu allows you to configure the power management features.

## **PnP/PCI Configurations**

This submenu allows you to configure certain “Plug and Play” and PCI options.

## **PC Health Status**

This submenu allows you to monitor the hardware of your system.

## **Frequency/ Voltage Control**

This submenu allows you to change CPU Vcore Voltage and CPU/PCI clock. (However, we suggest you to use the default setting. Changing the voltage and clock improperly may damage the CPU or M/B!)

## **Load Optimized Defaults**

This selection allows you to reload the BIOS when problem occurs during system booting sequence. These configurations are factory settings optimized for this system. A confirmation message will be displayed before defaults are set.



Load Optimized Defaults (Y/N)? N



# ***TForce 570 U***

---

## **Set Supervisor Password**

Setting the supervisor password will prohibit everyone except the supervisor from making changes using the CMOS Setup Utility. You will be prompted with to enter a password.



Enter Password:

## **Set User Password**

If the Supervisor Password is not set, then the User Password will function in the same way as the Supervisor Password. If the Supervisor Password is set and the User Password is set, the “User” will only be able to view configurations but will not be able to change them.



Enter Password:

## **Save & Exit Setup**

Save all configuration changes to CMOS (memory) and exit setup. Confirmation message will be displayed before proceeding.



SAVE to CMOS and EXIT (Y/N)? Y

## **Exit Without Saving**

Abandon all changes made during the current session and exit setup. Confirmation message will be displayed before proceeding.

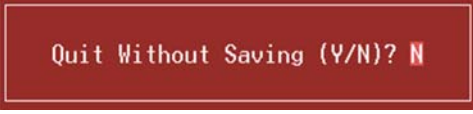

Quit Without Saving (Y/N)? N

# ***TForce 570 U***

---

## **Upgrade BIOS**

This submenu allows you to upgrade bios.

A screenshot of a BIOS utility prompt. The text "BIOS UPDATE UTILITY (Y/N)? N" is displayed in white on a dark red background. The prompt is enclosed in a thin white border.

BIOS UPDATE UTILITY (Y/N)? N

## **Integrate Flashing Program**

This is a very safe way to upgrade BIOS.

By pressing “Enter” key for three times, and the upgrading process will be completed easily.

A screenshot of a BIOS utility prompt. The text "BIOS UPDATE UTILITY <Y/N>? Y" is displayed in white on a dark red background. The prompt is enclosed in a thin white border.

BIOS UPDATE UTILITY <Y/N>? Y

# TForce 570 U

## 2 Standard CMOS Features

The items in Standard CMOS Setup Menu are divided into several categories. Each category includes no, one or more than one setup items. Use the arrow keys to highlight the item and then use the <PgUp> or <PgDn> keys to select the value you want in each item.

■ **Figure 2: Standard CMOS Setup**

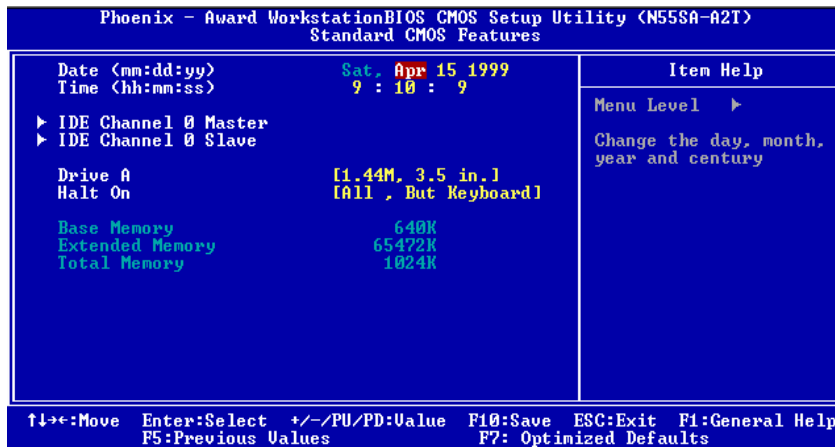

### Main Menu Selections

This table shows the items and the available options on the Main Menu.

Item	Options	Description
Date	mm : dd : yy	Set the system date. Note that the 'Day' automatically changes when you set the date.
Time	hh : mm : ss	Set the system internal clock.
IDE Primary Master	Options are in its sub menu.	Press <Enter> to enter the sub menu of detailed options
IDE Primary Slave	Options are in its sub menu.	Press <Enter> to enter the sub menu of detailed options.
IDE Secondary Master	Options are in its sub menu.	Press <Enter> to enter the sub menu of detailed options.

## ***TForce 570 U***

---

<b>Item</b>	<b>Options</b>	<b>Description</b>
IDE Secondary Slave	Options are in its sub menu.	Press <Enter> to enter the sub menu of detailed options.
Drive A Drive B	360K, 5.25 in 1.2M, 5.25 in 720K, 3.5 in 1.44M, 3.5 in 2.88M, 3.5 in None	Select the type of floppy disk drive installed in your system.
Halt On	All Errors No Errors All, but Keyboard All, but Diskette All, but Disk/ Key	Select the situation in which you want the BIOS to stop the POST process and notify you.
Base Memory	N/A	Displays the amount of conventional memory detected during boot up.
Extended Memory	N/A	Displays the amount of extended memory detected during boot up.
Total Memory	N/A	Displays the total memory available in the system.

# TForce 570 U

## 3 Advanced BIOS Features

■ Figure 3: Advanced BIOS Setup

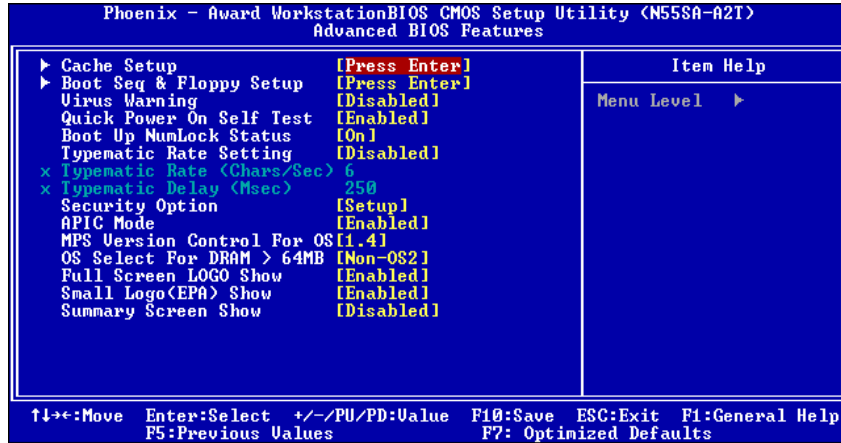

### Cache Setup

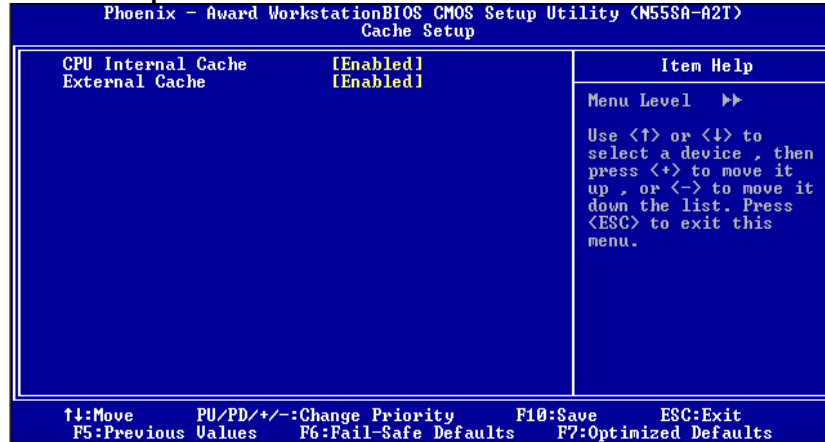

# TForce 570 U

---

## CPU Internal Cache

Depending on the CPU/chipset in use, you may be able to increase memory access time with this option.

**Enabled** (default) Enable cache.  
Disabled Disable cache.

## External Cache

This option enables or disables "Level 2" secondary cache on the CPU, which may improve performance.

**Enabled** (default) Enable cache.  
Disabled Disable cache.

## Boot Seq & Floppy Setup

This item allows you to setup boot sequence & Floppy.

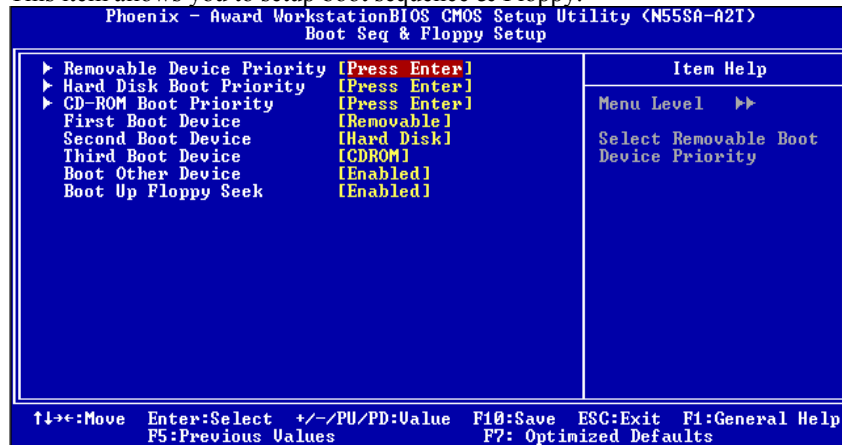

# TForce 570 U

## Removable Device Priority

Select Removable Boot Device Priority.

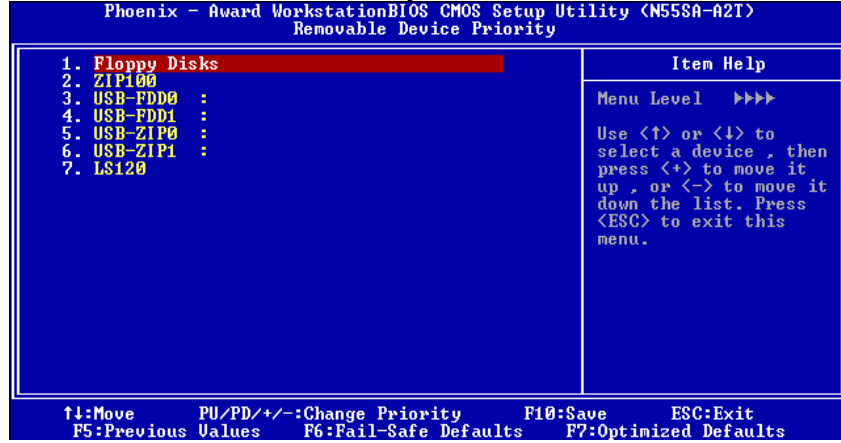

The Choices: Floppy Disks, Zip100, USB-FDD0, USB-FDD1, USB-ZIP0, USB-ZIP1, LS120.

## Hard Disk Boot Priority

The BIOS will attempt to arrange the Hard Disk boot sequence automatically.

You can change the Hard Disk booting sequence here.

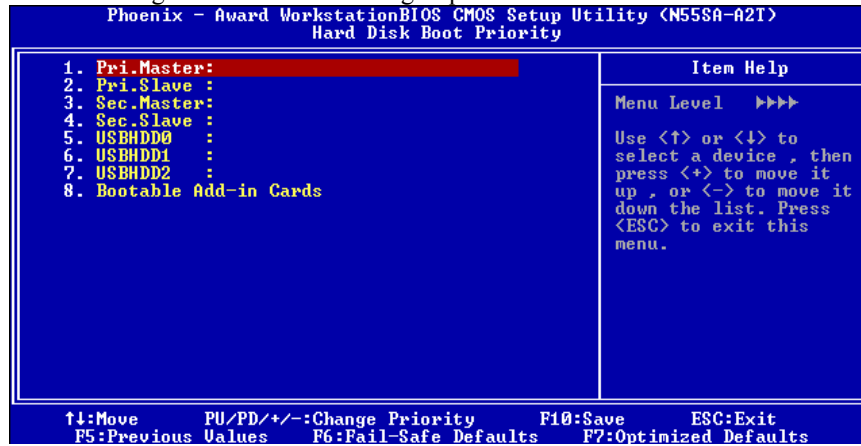

The Choices: Pri. Master, Pri. Slave, Sec. Master, Sec. Slave, USB HDD0, USB HDD1, USB HDD2, and Bootable Add-in Cards.

# TForce 570 U

---

## CD-ROM Boot Priority

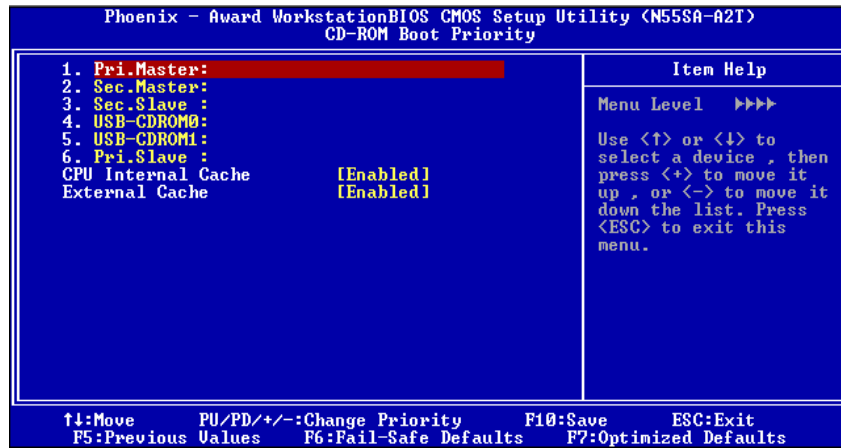

The Choices: Pri. Master, Pri. Slave, Sec. Master, Sec. Slave, USB CDROM0, USB CDROM 1.

### CPU Internal Cache

Depending on the CPU/chipset in use, you may be able to increase memory access time with this option.

**Enabled** (default) Enable cache.  
Disabled Disable cache.

### External Cache

This option enables or disables "Level 2" secondary cache on the CPU, which may improve performance.

**Enabled** (default) Enable cache.  
Disabled Disable cache.



# ***TForce 570 U***

---

## **First/Second/Third Boot Device**

The BIOS will attempt to load the operating system in this order.

**The Choices:** Floppy, LS120, HDD-0, SCSI, CDROM, HDD-1, HDD-2, HDD-3, ZIP100, LAN, HPT370, Disabled.

## **Boot Other Device**

When enabled, BIOS will try to load the operating system from other device when it failed to load from the three devices above.

**The Choices:** Enabled (default), Disabled

## **Swap Floppy Drive**

For systems with two floppy drives, this option allows you to swap logical drive assignments.

**The Choices:** Disabled (default), Enabled.

## **Boot Up Floppy Seek**

When enabled, System will test the floppy drives to determine if they have 40 or 80 tracks during boot up. Disabling this option reduces the time it takes to boot-up.

**The Choices:** Enabled (default), Disabled.

## **Virus Warning**

This option allows you to choose the VIRUS Warning feature that is used to protect the IDE Hard Disk boot sector. If this function is enabled and an attempt is made to write to the boot sector, BIOS will display a warning message on the screen and sound an alarm beep.

**Disabled** (default) Virus protection is disabled.

**Enabled** Virus protection is activated.

## **Quick Power On Self Test**

Enabling this option will cause an abridged version of the Power On Self-Test (POST) to execute after you power up the computer.

**Disabled** Normal POST.

**Enabled** (default) Enable quick POST.

# ***TForce 570 U***

---

## **Boot Up NumLock Status**

Selects the NumLock State after the system switched on.

The Choices:

**On** (default)      Numpad is number keys.  
Off                      Numpad is arrow keys.

## **Typematic Rate Setting**

When a key is held down, the keystroke will repeat at a rate determined by the keyboard controller. When enabled, the typematic rate and typematic delay can be configured.

**The Choices:** Disabled (default), Enabled.

## **Typematic Rate (Chars/Sec)**

Sets the rate at which a keystroke is repeated when you hold the key down.

**The Choices:** 6 (default), 8, 10, 12, 15, 20, 24, 30.

## **Typematic Delay (Msec)**

Sets the delay time after the key is held down before it begins to repeat the keystroke.

**The Choices:** 250 (default), 500, 750, 1000.

## **Security Option**

This option will enable only individuals with passwords to bring the system online and/or to use the CMOS Setup Utility.

System:                      A password is required for the system to boot and is also required to access the Setup Utility.

**Setup** (default):      A password is required to access the Setup Utility only.

This will only apply if passwords are set from the Setup main menu.

## **APIC MODE**

Selecting Enabled enables APIC device mode reporting from the BIOS to the operating system.

**The Choices:** Enabled (default), Disabled.

# ***TForce 570 U***

---

## **MPS Version Control For OS**

The BIOS supports version 1.1 and 1.4 of the Intel multiprocessor specification. Select version supported by the operation system running on this computer.

**The Choices:** 1.4 (default), 1.1.

## **OS Select For DRAM > 64MB**

A choice other than Non-OS2 is only used for OS2 systems with memory exceeding 64MB.

**The Choices:** Non-OS2 (default), OS2.

## **Full Screen LOGO Show**

This item allows you to enable/disable Full Screen LOGO Show.

**The Choices:** Enabled (default), Disabled.

## **Small Logo(EPA) Show**

This item allows you to select whether the “Small Logo” shows. Enabled (default) “Small Logo” shows when system boots up. Disabled No “Small Logo” shows when system boots

**The Choices:** Enabled (default), Disabled.

## **Summary Screen Show**

This item allows you to enable/disable the summary screen. Summary screen means system configuration and PCI device listing.

**The Choices:** Disabled (default), Enabled.

# TForce 570 U

## 4 Advanced Chipset Features

This submenu allows you to configure the specific features of the chipset installed on your system. This chipset manage bus speeds and access to system memory resources, such as DRAM. It also coordinates communications with the PCI bus. The default settings that came with your system have been optimized and therefore should not be changed unless you are suspicious that the settings have been changed incorrectly.

■ **Figure 4: Advanced Chipset Setup**

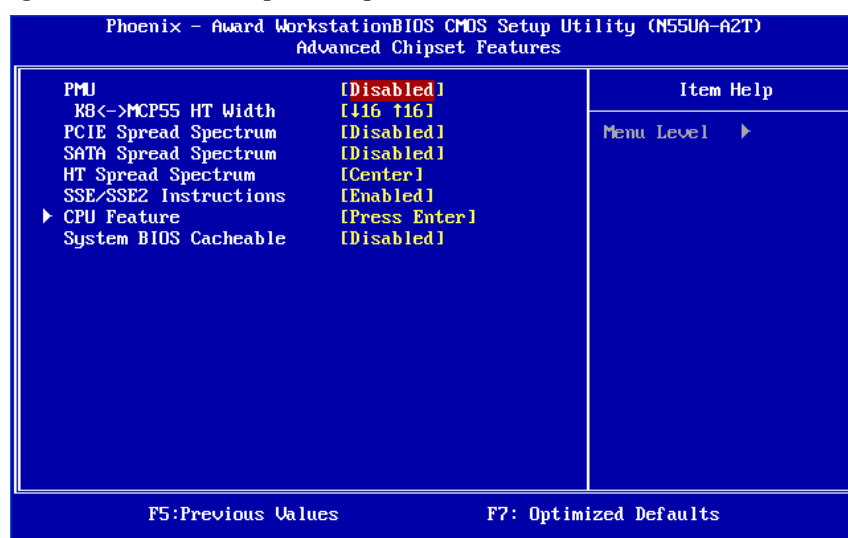

### PMU

This item allows you to enable or disable the PMU function.  
**The Choices:** Disabled (default), Auto.

### K8<->MCP55 HT Width

This item allows you to select the K8<->MCP55 HT Width.  
**The Choices:** [ ↓ 16 ↑ 16 ] (default), [ ↓ 8 ↑ 8 ].

### SATA /PCIE Spread Spectrum

This item allows you to enable/disable the Spread Spectrum function.

# TForce 570 U

---

The Choices: Disabled (default), Enabled.

## HT Spread Spectrum

This item allows you to select HT Spread Spectrum function.

The Choices: Disabled (default), Center, Down.

## SSE/SSE2 instruction

This item allows you to enable/disable SSE/SSE2 instruction.

The Choices: Enabled (default), Disabled.

## CPU Feature

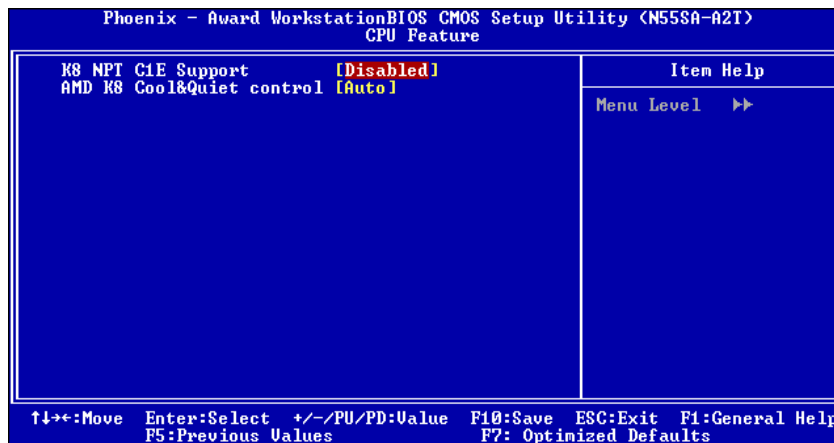

### **K8 NPT C1E Support**

The Choices: Disabled (default), Enabled.

### **AMD K8 Cool&Quiet control**

The Choices: Auto (default).

## ***TForce 570 U***

---

### **System BIOS Cacheable**

Selecting the “Enabled” option allows caching of the system BIOS ROM at F0000h-FFFFFh, which is able to improve the system performance. However, any programs that attempts to write to this memory block will cause conflicts and result in system errors.

**The Choices:** **Disabled** (default), Enabled.

# TForce 570 U

## 5 Integrated Peripherals

■ Figure 5. Integrated Peripherals

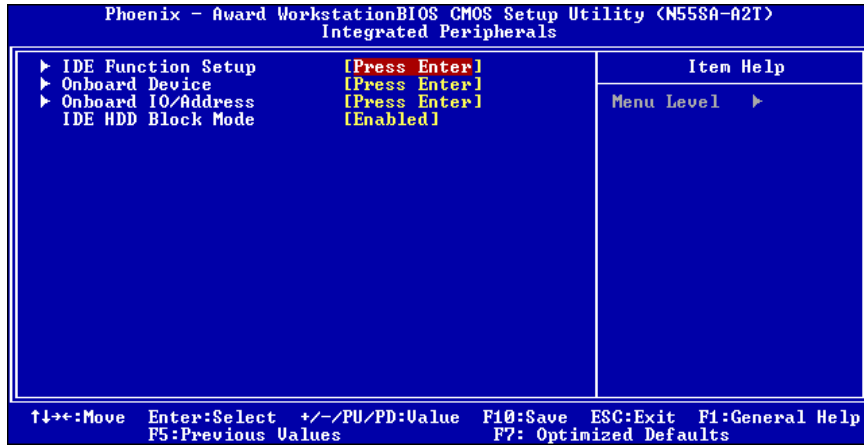

### IDE Function Setup

Highlight the “Press Enter” label next to the “IDE Function Setup” label and press enter key will take you a submenu with the following options:

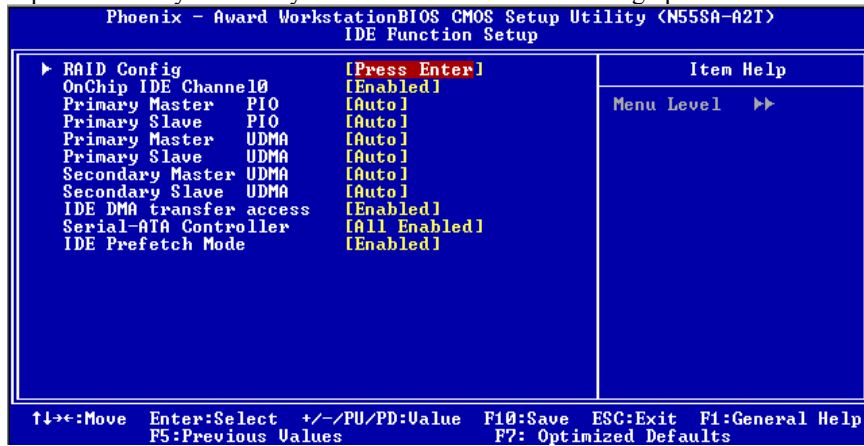

# TForce 570 U

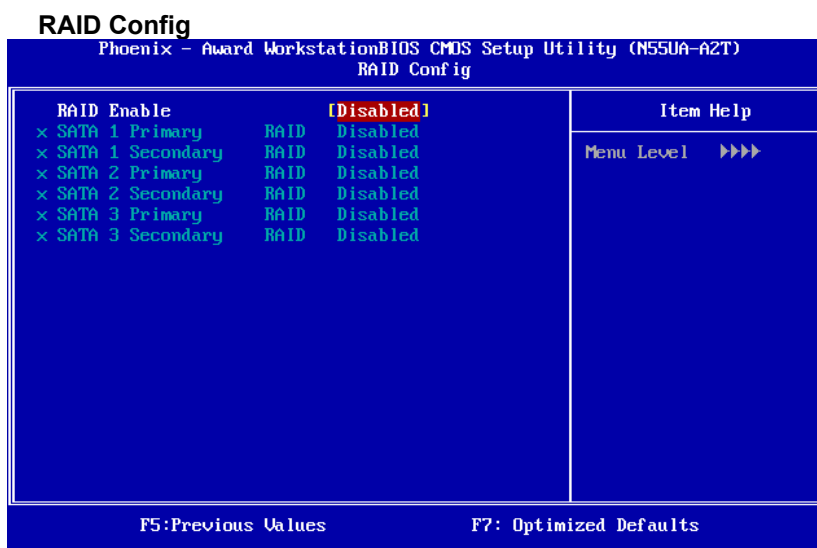

## RAID Enable

This option allows you to enable or disable RAID function.

**The Choices:** Disabled (default), Enabled.

## SATA 1/2/3 Primary/Secondary RAID

This option allows you to enable or disable SATA A Primary/Secondary RAID.

**The Choices:** Disabled (default), Enabled.

## On-chip IDE Channel 0/1

The motherboard chipset contains a PCI IDE interface with support for two IDE channels. Select "Enabled" to activate the first and/or second IDE interface. Select "Disabled" to deactivate an interface if you are going to install a primary and/or secondary add-in IDE interface.

**The Choices:** Enabled (default), Disabled.

## Primary/Secondary/Master/Slave PIO

The IDE PIO (Programmed Input / Output) fields let you set a PIO mode (0-4) for each of the IDE devices that the onboard IDE interface supports. Modes 0 to 4 will increase performance progressively. In Auto mode, the system automatically determines the best mode for each device.

**The Choices:** Auto (default), Mode0, Mode1, Mode2, Mode3, Mode4.



# TForce 570 U

## IDE Primary/Secondary/Master/Slave UDMA

Ultra DMA function can be implemented if it is supported by the IDE hard drives in your system. As well, your operating environment requires a DMA driver (Windows 95 or OSR2 may need a third party IDE bus master driver). If your hard drive and your system software both support Ultra DMA, select Auto to enable BIOS support.

**The Choices:** Auto (default), Disabled.

## IDE DMA Transfer Access

This item allows you to enable or disable the IDE DMA transfer access.

**The Choices:** Enabled (default), Disabled.

## Serial-ATA Controller

**The Choices:** ALL Enabled (default).

## IDE Prefetch Mode

The “onboard” IDE drive interfaces supports IDE prefetch function for faster drive access. If the interface on your drive does not support prefetching, or if you install a primary and/or secondary add-in IDE interface, set this option to “Disabled”.

**The Choices:** Enabled (default), Disabled.

## Onboard Device

Highlight the “Press Enter” label next to the “Onboard Device” label and press the enter key will take you a submenu with the following options:



# ***TForce 570 U***

---

## **OnChip USB**

This option should be enabled if your system has a USB installed on the system board. You may need to disable this feature if you add a higher performance controller.

**The Choices:** V1.1+V2.0 (default), Disabled, V1.1

## **USB Memory Type**

**The Choices:** SHADOW (default).

## **USB Keyboard Support**

This item allows you to enable or disable the USB Keyboard Legacy Support.

Enabled                    Enable USB Keyboard Support.

**Disabled** (default)    Disable USB Keyboard Support.

## **USB Mouse Support**

This item allows you to enable or disable the USB Mouse Legacy Support.

Enabled Enable        USB Mouse Support.

**Disabled** (default)    Disable USB Mouse Support.

## **HD Audio**

**The Choices:** Auto (default), Disabled.

## **MAC LAN**

This option allows you to control the onboard MAC LAN.

**The Choices:** Auto (default), Disabled.

## **Onboard LAN Boot ROM**

This item allows you to enable or disable the Onboard LAN Boot ROM.

**The Choices:** Disabled (default), Enabled.

## **MAC Media Interface**

This option allows you to control the onboard MAC Media Interface.

**The Choices:** Pin Strap (default), Disabled

# TForce 570 U

---

## Onboard I/O Address

Press Enter to configure the Onboard I/O Address.

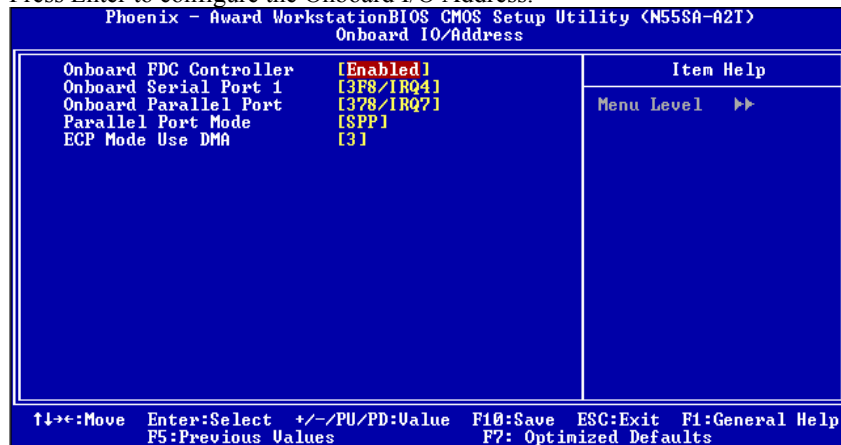

### **Onboard FDC Controller**

Select enabled if your system has a floppy disk controller (FDC) installed on the system board and you wish to use it. If you installed another FDC or the system uses no floppy drive, select disabled in this field.

**The Choices:** Enabled (default), Disabled.

### **Onboard Serial Port 1**

Select an address and corresponding interrupt for the first and second serial ports.

**The Choices:** 3F8/IRQ4 (default), Disabled, 2F8/IRQ3, 3E8/IRQ4, 2E8/IRQ3, Auto.

### **Onboard Parallel Port**

This item allows you to determine access onboard parallel port controller with which I/O Address.

**The Choices:** 378/IRQ7 (default), 278/IRQ5, 3BC/IRQ7, Disabled.

# ***TForce 570 U***

---

## **Parallel Port Mode**

This item allows you to determine how the parallel port should function. The default value is SPP.

### **The Choices:**

<b>SPP</b> (default)	Using Parallel port as Standard Printer Port.
EPP	Using Parallel Port as Enhanced Parallel Port.
ECP	Using Parallel port as Extended Capabilities Port.
ECP+EPP	Using Parallel port as ECP & EPP mode.

## **ECP Mode Use DMA**

Select a DMA Channel for the port.

**The Choices:** 3 (default), 1.

## **IDE HDD Block Mode**

Block mode is also called block transfer, multiple commands, or multiple sectors read / write. If your IDE hard drive supports block mode (most new drives do), select Enabled for automatic detection of the optimal number of block mode (most new drives do), select Enabled for automatic detection of the optimal number of block read / write per sector where the drive can support.

**The Choices:** Enabled (default), Disabled.

# TForce 570 U

## 6 Power Management Setup

The Power Management Setup Menu allows you to configure your system to utilize energy conservation and power up/power down features.

■ **Figure 6. Power Management Setup**

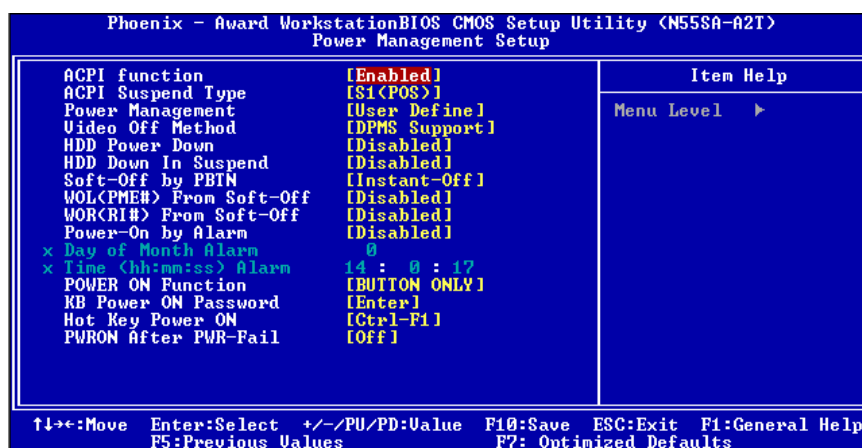

### ACPI Function

This item displays the status of the Advanced Configuration and Power Management (ACPI).

**The Choices:** **Enabled** (default), Disabled.

### ACPI Suspend Type

The item allows you to select the suspend type under the ACPI operating system.

**The Choices:**    **S1 (POS)** (default) Power on Suspend  
                  **S3 (STR)** Suspend to RAM  
                  **S1 & S3 POS+STR**

# TForce 570 U

---

## **Power Management**

This category allows you to select the power saving method and is directly related to the following modes:

1. HDD Power Down.
2. Suspend Mode.

There are three options of Power Management, three of which have fixed mode settings

*Min. Power Saving*

Minimum power management.

Suspend Mode = 1 hr.

HDD Power Down = 15 min

*Max. Power Saving*

Maximum power management only available for sl CPU's.

Suspend Mode = 1 min.

HDD Power Down = 1 min.

**User Define** (default)

Allow you to set each option individually.

When you choose user define, you can adjust each of the item from 1 min. to 1 hr. except for HDD Power Down which ranges from 1 min. to 15 min.

## **Video Off Method**

This option determines the manner when the monitor goes blank.

V/H SYNC+Blank

This selection will cause the system to turn off the vertical and horizontal synchronization ports and write blanks to the video buffer.

Blank Screen

This option only writes blanks to the video buffer.

**DPMS (default)**

Initial display power management signaling.

## **HDD Power Down**

When enabled, the hard-disk drives will power down after a set time of system inactivity. All other devices remain active.

**The Choices: Disabled** (default), 1 Min, 2 Min, 3 Min, 4 Min, 5 Min, 6 Min, 7 Min, 8 Min, 9 Min, 10 Min, 11 Min, 12 Min, 13 Min, 14 Min, 15Min.

# ***TForce 570 U***

---

## **HDD Down In Suspend**

**The Choices:** Disabled (default), Enabled.

## **Soft-Off by PWR-BTN**

This item determines the behavior of system power button. Instant off turn off the power immediately, and Delay 4 Sec. will require you to press and hold the power button for 4 seconds to cut off the system power.

**The Choices:** Delay 4 Sec, **Instant-Off** (default).

## **WOL(PME#)/ From Soft-Off**

This item allows you to enable or disable Wake On LAN from Soft-Off function.

**The Choices:** Disabled (default), Enabled.

## **WOR(RI#) From Soft-Off**

This item allows you to enable or disable Wake On Ring from Soft-Off function.

**The Choices:** Disabled (default), Enabled.

## **Power-On by Alarm**

This function is for setting date and time for your computer to boot up. When enabled, you can choose the date and time to boot up the system.

**The Choices:** Disabled (default), Enabled.

### **Date (of Month) Alarm**

You can choose which month the system will boot up.

### **Time (hh:mm:ss) Alarm**

You can choose the system boot up time, input hour, minute and second to specify.

**Note: If you have change the setting, you must let the system boot up until it goes to the operating system, before this function will work.**

## **POWER ON Function**

This item allows you to choose the power on method.

**The Choices:** **Button Only**(default), Password, Hot Key, Mouse/Click, Mouse Double/Click, Any Key, Keyboard 98.

# ***TForce 570 U***

---

## **KB Power ON Password**

Input password and press Enter to set the Keyboard power on password.

## **Hot Key Power ON**

Choose the Hot Key combination to boot up the system.

**The Choices:** Ctrl-F1(default), Ctrl-F2, Ctrl-F3, Ctrl-F4, Ctrl-F5, Ctrl-F6, Ctrl-F7, Ctrl-F8, Ctrl-F9, Ctrl-F10, Ctrl-F11, and Ctrl-F12.

## **POWER After PWR-Fail**

This setting specifies how your system should behave after a power fail or interrupts occurs. By choosing off will leave the computer in the power off state. Choosing On will reboot the computer. Former-Sts will restore the system to the status before power failure or interrupt occurs.

**The Choices:** Off (default), On, Former-Sts.



# TForce 570 U

## 7 PnP/PCI Configurations

This section describes configuring the PCI bus system. PCI, or Personal Computer Interconnect, is a system which allows I/O devices to operate at speeds nearing the speed of the CPU itself uses when communicating with its own special components. This section covers some very technical items and it is strongly recommended that only experienced users should make any changes to the default settings.

### ■ Figure 7: PnP/PCI Configurations

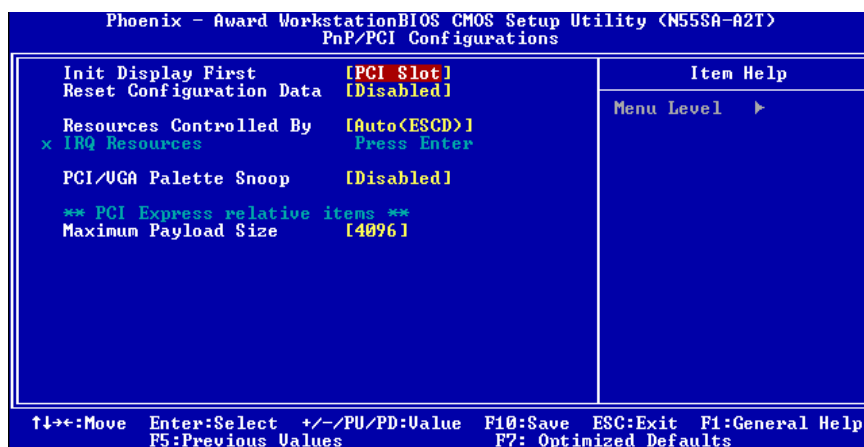

### Init Display First

This item allows you to decide to active whether PCI Slot or on-chip VGA first.  
**The Choices:** PCEx, PCI Slot (default).

### Reset Configuration Data

The system BIOS supports the PnP feature which requires the system to record which resources are assigned and protects resources from conflict. Every peripheral device has a node, which is called ESCD. This node records which resources are assigned to it. The system needs to record and update ESCD to the memory locations. These locations are reserved in the system BIOS. If the Disabled (default) option is chosen, the system's ESCD will update only when the new configuration varies from the last one. If the Enabled option is chosen,

## ***TForce 570 U***

---

the system is forced to update ESCDs and then is automatically set to the “Disabled” mode.

The above settings will be shown on the screen only if “Manual” is chosen for the resources controlled by function.

Legacy is the term, which signifies that a resource is assigned to the ISA Bus and provides non-PnP ISA add-on cards. PCI / ISA PnP signify that a resource is assigned to the PCI Bus or provides for ISA PnP add-on cards and peripherals.

**The Choices:** Disabled (default), Enabled.

### **Resources Controlled By**

By Choosing “Auto(ESCD)” (default), the system BIOS will detect the system resources and automatically assign the relative IRQ and DMA channel for each peripheral. By Choosing “Manual”, the user will need to assign IRQ & DMA for add-on cards. Be sure that there are no IRQ/DMA and I/O port conflicts.

**The Choices:** Auto (ESCD) (default), Manual.

### **IRQ Resources**

This submenu will allow you to assign each system interrupt a type, depending on the type of device using the interrupt. When you press the “Press Enter” tag, you will be directed to a submenu that will allow you to configure the system interrupts. This is only configurable when “Resources Controlled By” is set to “Manual”.

IRQ-3	assigned to PCI Device
IRQ-4	assigned to PCI Device
IRQ-5	assigned to PCI Device
IRQ-7	assigned to PCI Device
IRQ-9	assigned to PCI Device
IRQ-10	assigned to PCI Device
IRQ-11	assigned to PCI Device
IRQ-12	assigned to PCI Device
IRQ-14	assigned to PCI Device
IRQ-15	assigned to PCI Device

### **PCI / VGA Palette Snoop**

Some old graphic controllers need to “snoop” on the VGA palette and then map it to their display as a way to provide boot information and VGA compatibility. This item allows such snooping to take place.

**The Choices:** Disabled (default), Enabled

## ***TForce 570 U***

---

### **Maximum Payload Size**

Set the maximum payload size for Transaction packets (TLP).

**The Choice:** 4096 (default.), 128, 256, 512, 1024, 2048.

# TForce 570 U

## 8 PC Health Status

■ Figure 8: PC Health Status

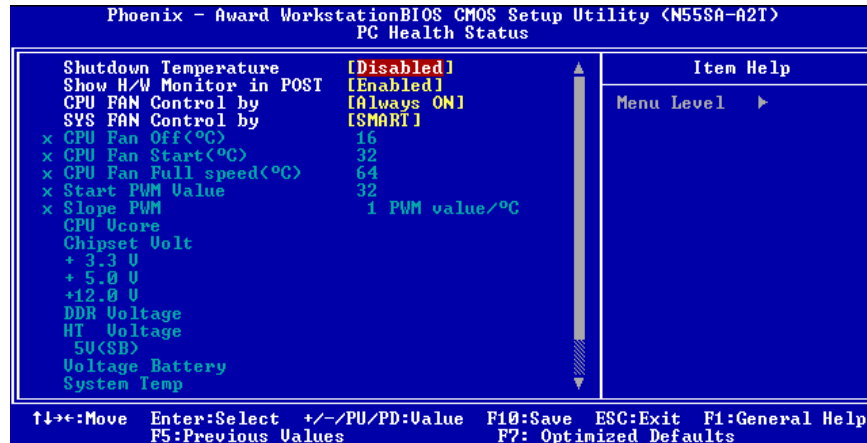

### Shutdown Temperature

This item allows you to set up the CPU shutdown Temperature. This item is only effective under Windows 98 ACPI mode.

**The Choices:** Disabled (default), 70°C / 158°F, 75°C / 167°F, 80°C / 176°F.

### Show H/W Monitor in POST

If your computer contains a monitoring system, it will show PC health status during POST stage. The item offers several different delay times.

**The Choices:** Enabled (default), Disabled.

### CPU FAN Control by

Choose "smart" to reduce the noise caused by CPU FAN.

**The Choices:** Always On (default), Smart.

### SYS FAN Control by

Choose "smart" to reduce the noise caused by the System FAN.

**The Choices:** SMART (default), Always On.

# ***TForce 570 U***

---

## **CPU Fan Off<°C>**

If the CPU Temperature is lower than the set value, FAN will turn off.  
**The Choices: 16** (default).

## **CPU Fan Start<°C>**

CPU fan starts to work under smart fan function when arrive this set value.  
**The Choices: 32**(default).

## **CPU Fan Full speed <°C>**

When CPU temperature is reach the set value, the CPU fan will work under Full Speed.  
**The Choices: 64**(default).

## **Start PWM Value**

When CPU temperature arrives to the set value, the CPU fan will work under Smart Fan Function mode. The range is from 0~127, with an interval of 1.  
**The Choices: 32** (default).

## **Slope PWM**

Increasing the value of slope PWM will raise the speed of CPU fan.  
**The Choices: 1 PWM Value/°C**(default), 2 PWM Value/°C, 4 PWM Value/°C, 8 PWM Value/°C, 16 PWM Value/°C, 32 PWM Value/°C, 64PWM Value/°C.

## **CPU Vcore, Chipset Volt, +3.3V, +5.0V, +12.0V, DDR Voltage, HT Voltage, 5V<SB>, Voltage Battery**

Detect the system's voltage status automatically.

## **SYSTEM Temp**

This field displays the current temperature of SYSTEM.

## **CPU Temp**

This field displays the current temperature of CPU.

## **Current CPU FAN Speed**

## ***TForce 570 U***

---

This field displays the current speed of CPU fan.

### **Current SYS FAN Speed**

This field displays the current speed SYSTEM fan.

### **Current NB FAN Speed**

This field displays the current speed NB fan.

# TForce 570 U

## 9 Frequency/ Voltage Control

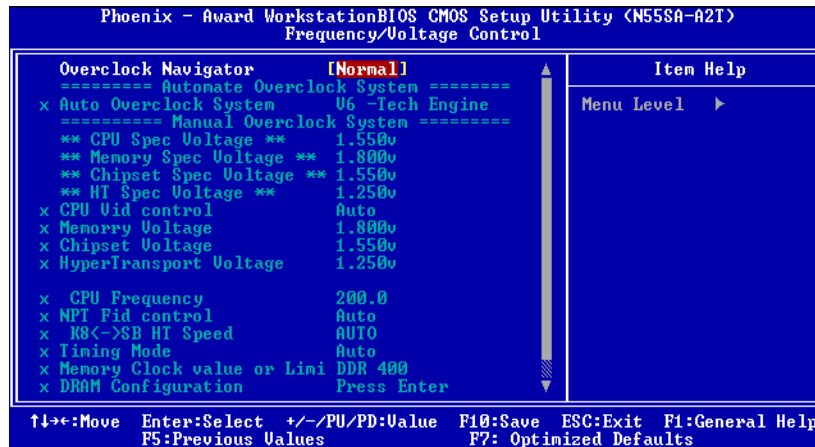

### OverClock Navigator

OverClock Navigator is designed for beginners in overlock field. Based on many test and experiments from Biostar Engineer Team, OverClock Navigator provides 3 default overlock configurations that are able to raise the system performance

**The Choices:** Normal (default), Automate Overclock, Manual Overlock

# TForce 570 U

## Auto OverClock System

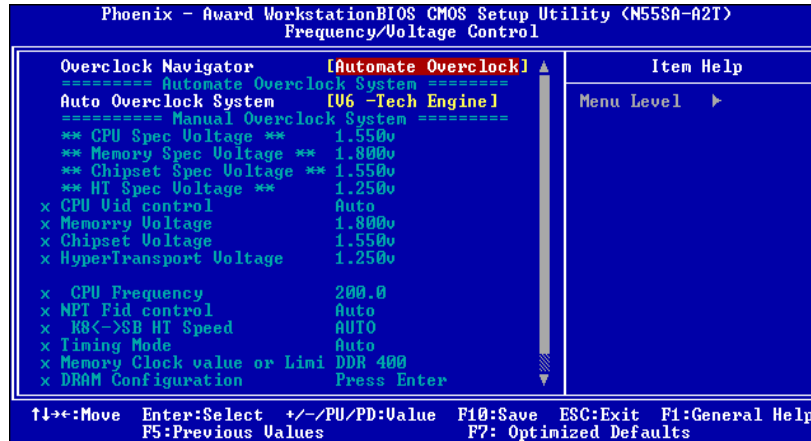

The Overclock Navigator provides 3 different engines helping you to overclock your system. These engines will boost your system performance to different level.

The Choices:

V6 Tech Engine

This setting will raise about 5%~10% of whole system performance.

V8 Tech Engine

This setting will raise about 15%~25% of whole system performance.

V12 Tech Engine

This setting will raise about 25%~30% of whole system performance.

### Cautions:

1. Not every AMD CPU performs the above overclock setting ideally; the difference may vary with the installed CPU model.
2. From BET experiment, the Atholon64 FX CPU is not suitable for this A.O.S. feature.



# TForce 570 U

## Manual Overclock System (M.O.S.)

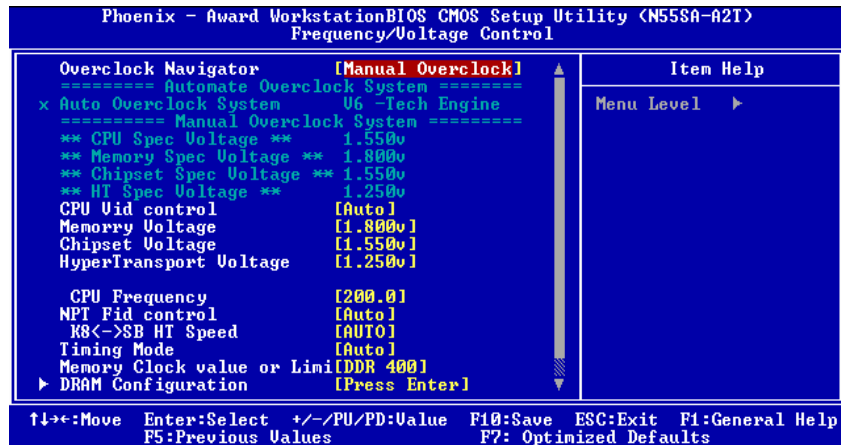

MOS is designed for experienced overclock users.

It allows users to customize personal overclock setting.

### Note:

Based on our test results; the overclock function achieved the best performance on AMD 3000+ CPU

### CPU Vid control

The Choices: Auto (default).

### Memory Voltage

The Choices: 1.950V (default), 2.000V, 2.050V, 2.100V.

### Chipset Voltage

The Choices: 1.550V (default), 1.600V, 1.650V, 1.700V.

### HyperTransport Voltage

The Choices: 1.250V (default), 1.300V, 1.350V, 1.400V.

### CPU Frequency

This item allows you to select the CPU Frequency.

The Choices: 200 (default), 201, 202, 203, 204, 205, 206, 207, 208, 209 ... 450 ( Max is 450).

### NPT Fid control

The Choices: AUTO (default).

# TForce 570 U

## K8<->SB HT Speed

The Choices: AUTO (default).

## Memory Clock Value OR Limi

The Choices: DDR 400 (default).

## Timing Mode

This item allows you to choose to manually or automatically regulate the DDR Timing.

The Choices: Auto (default), Manual.

## DRAM Configuration

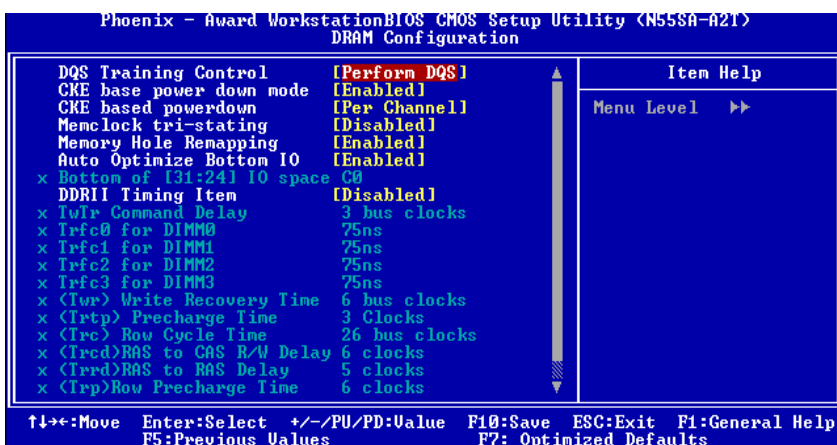

## DQS Training Control

The Choices: Perform DQS (default), Skip DQS.

## CKE base power down mode

The Choices: Enabled (default), Disabled.

## CKE based power down

The Choices: Per Channel (default), Per CS.

## Memclock tri-stating

The Choices: Disabled (default), Enabled.

## Memory Hole Remapping

The Choices: Enabled (default), Disabled.

# ***TForce 570 U***

---

## **Auto Optimize Bottom IO**

The Choices: Enabled (default), Disabled.

## **Bottom of [31:24] IO space**

The Choices: C0 (default).

## **DDRII Timing Item**

The Choices: Disabled (default), Enabled.

## **TwTr Command Delay**

The Choices: 3 bus clocks (default).

## **TrTfc0 for DIMM0**

The Choices: 75ns (default).

## **TrTfc1 for DIMM1**

The Choices: 75ns (default)

## **TrTfc2 for DIMM2**

The Choices: 75ns (default)

## **TrTfc3 for DIMM3**

The Choices: 75ns (default)

## **<Twr> Write Recovery Time**

The Choices: 6 bus clocks (default).

## **<Trtp> Precharge Time**

The Choices: 3 clocks (default).

## **<Trc> Row Cycle Time**

The Choices: 26 bus clocks (default).

## **<Trcd> RAS to CAS R/W Delay**

The Choices: 6 clocks (default).

## **<Trrd> RAS to RAS Delay**

The Choices: 5 clocks (default).

## **<Trp> Row Precharge Time**

The Choices: 6 clocks (default).

## **<Tras> Minimum RAS Active T**

The Choices: 18 bus clocks (default).

# TForce 570 U

## Integrated Memory Test

Integrated Memory Test allows users to test memory module compatibilities without additional device or software.

### Step 1:

This item is disabled on default; change it to “Enable” to precede memory test.

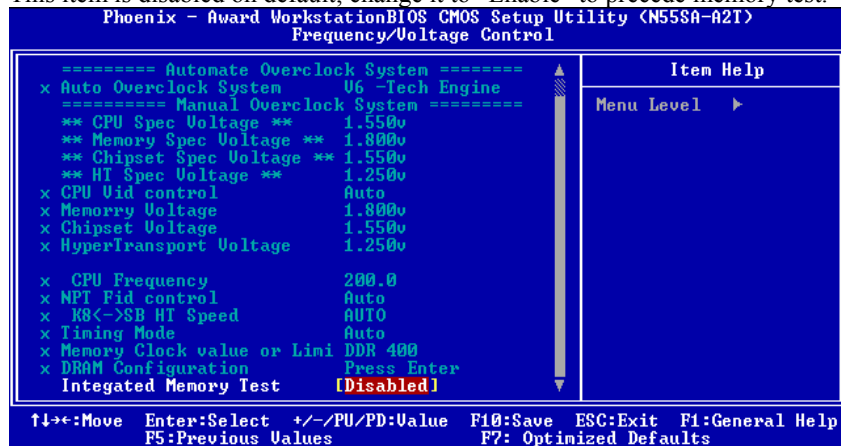

### Step 2:

When the process is done, change the setting back from “Enabled” to “Disabled” to complete the test.

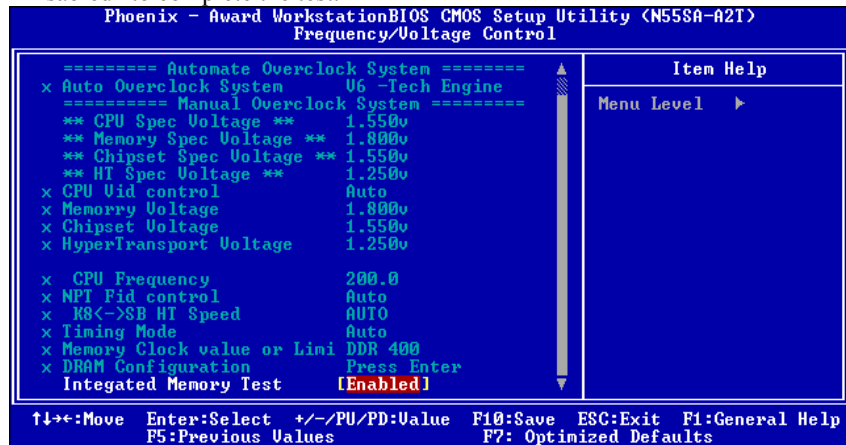

# TForce 570 U

---

## 10 CMOS Reload Program (C.R.P.)

The CMOS Reload Program (CRP) allows you to save different CMOS settings into BIOS-ROM. You may reload any saved CMOS setting to change system configurations. Moreover, you may save your ideal overclock setting for easier overclocking. There are 50 sets record addresses in total, and you may name the saved CMOS data individually.

