



User Guide

TF650i Ultra-A7
Motherboard for
Intel Processor

Installation and Configuration

Table of Contents

Before You Begin...	viii
Parts NOT in the Kit.....	viii
Intentions of the Kit	ix
Introduction	1
Features	1
Ultimate Overclocking	1
Guaranteed FSB speeds	1
High-speed Memory.....	1
Comprehensive Overclocking Tools.....	1
NVIDIA nTune Utility.....	2
NV BIOS	2
True x16 PCI Express Support	2
DualDDR2 Memory Architecture.....	2
NVIDIA MediaShield™ Storage	2
Multiple Disk Setup	2
DiskAlert System.....	3
RAID Morphing	3
Bootable Multidisk Array.....	3
Networking with NVIDIA nForce	3
NVIDIA Native Gigabit Ethernet.....	3
NVIDIA FirstPacket™ Technology	3
High Definition Audio (HDA).....	4
USB 2.0.....	4
Motherboard Specifications	5
TF650i Ultra-A7 Motherboard	7
Hardware Installation	10
Safety Instructions	10

Preparing the Motherboard	11
Installing the CPU	11
Installing the CPU Fan.....	12
Installing Memory DIMMs.....	12
Installing the Motherboard.....	13
Installing the I/O Shield	13
Securing the Motherboard into the Chassis.....	13
Connecting Cables and Setting Switches.....	14
Power Connections	15
24-pin ATX Power (PWR1).....	15
4-pin ATX 12V Power (PWR2).....	16
Connecting IDE Hard Disk Drives.....	16
Connecting Serial ATA Cables.....	16
Connecting Internal Headers	18
Front Panel Header	18
USB Headers	20
Fan Connections.....	21
COM1.....	21
FDD Connector	21
Expansion Slots	22
PCI Slots	22
PCI Express x1 Slot	23
PCI Express x16 Slots.....	23
Jumper Settings	23
Clear CMOS Jumper: CLR_CMOS.....	23
Configuring the BIOS.....	24
Enter BIOS Setup	25

Main Menu	25
Standard CMOS Features Menu	28
Date and Time.....	29
IDE Channel and SATA Channel.....	29
Drive A.....	31
Halt On	31
Memory	32
Advanced BIOS Features.....	33
Removable Device Priority.....	34
Hard Disk Boot Priority.....	34
Network Boot Priority.....	34
CPU Internal Cache.....	34
Quick Power On Self Test.....	35
First/Second/Third Boot Device.....	35
Boot Other Device	35
Boot Up NumLock Status.....	35
Security Option.....	36
APIC Mode	36
MPS Version Control For OS	36
Full Screen LOGO Show	36
Advanced Chipset Features.....	37
System Clocks	38
Frequency Settings.....	39
HT Multiplier.....	40
Spread Spectrum	40
FSB & Memory Config	41
CPU Configuration	45
System Voltages.....	46

NVMEM Memory Test.....	48
Load Timing/Voltage Set.....	48
Save Timing/Voltage Set.....	49
System BIOS Cacheable.....	49
HPET Function.....	49
NVIDIA GPU Ex	49
Integrated Peripherals Menu	50
IDE Function Setup.....	51
RAID Config	52
USB Config.....	52
MAC Config	53
HD Audio	53
IDE HDD Block Mode	53
Onboard FDC Controller	53
Onboard Serial Port 1.....	53
Power Management Setup Menu	54
ACPI Function.....	54
ACPI Suspend Type	54
Soft-Off by PBNT	55
WOL(PME#) From Soft-Off.....	55
Power On by Alarm.....	55
POWER ON Function.....	55
PnP/PCI Configuration Menu	56
Init Display First	57
Reset Configuration Data	57
Resources Controlled By.....	57
IRQ Resources.....	58

PCI/VGA Palette Snoop	58
Maximum Payload Size.....	58
System Monitor Menu	59
Dynamic Fan Control.....	60
Index.....	62

List of Figures

Figure 1.	TF650i Ultra-A7 Motherboard Layout.....	8
Figure 2.	Chassis Backpanel Connectors.....	9
Figure 3.	PWR1 Motherboard Connector.....	15
Figure 4.	Expansion Slots.....	22
Figure 5.	BIOS CMOS Setup Utility Main Menu.....	26
Figure 6.	Standard CMOS Features Menu.....	28
Figure 7.	Advanced BIOS Features Menu.....	33
Figure 8.	Advanced Chipset Features.....	37
Figure 9.	System Clocks Menu.....	38
Figure 10.	FSB & Memory Config Menu.....	41
Figure 11.	CPU Configuration Menu.....	45
Figure 12.	System Voltages Menu.....	46
Figure 13.	Integrated Peripherals Menu.....	50
Figure 14.	Power Management Setup Menu.....	54
Figure 15.	PnP/PCI Configuration Menu.....	56
Figure 16.	System Monitor Menu.....	59



Before You Begin...

Parts NOT in the Kit

This kit contains all the hardware necessary to install and connect your new TF650i Ultra-A7 motherboard. However, it does not contain the following items that must be purchased separately to make the motherboard functional.

- ❑ Intel microprocessor:
Intel Core 2 Extreme, Intel Core 2 Quad, Intel Core 2 Dual, Pentium
- ❑ Cooling fan for the microprocessor
- ❑ System memory support:
Supports dual channel DDR2 533/667/800. Supports up to 8 GBs DDR2 memory.
- ❑ Power Supply
To calculate the power you are going to require for your specific configuration, go to www.slizone.com.

These instructions tell you how to install each of the parts listed so you can have a functioning motherboard. As you go through the installation instructions, we are assuming you have purchased the necessary parts.

Intentions of the Kit

This kit provides you with the motherboard and all connecting cables necessary to install the motherboard into a PC cabinet. If you are *building* a PC, you will use most of the cables provided in the kit. If however, you are *replacing* a motherboard, you will not need many of the cables.

When *replacing* a motherboard in a PC cabinet, you will need to reinstall an operating system even though the current drives have an operating system.



Introduction

Thank you for buying the TF650i Ultra-A7 Motherboard. This motherboard offers the tools and performance PC users' demand.

Features

Ultimate Overclocking

Unleash the underlying hardware. With comprehensive overclocking tools to push the limits on front side bus (FSB) speed and support for higher memory speeds, the NVIDIA nForce 650i Ultra MCPs were designed for overclocking.

Guaranteed FSB speeds

Reach FSB speeds of 1333MHz with a CPU that supports this specification.

High-speed Memory

This board supports high-speed memory up to DDR2-800 to keep pace with overclocked system components.

Comprehensive Overclocking Tools

Award-winning NVIDIA overclocking tools provide a complete kit of tools giving everyone from the most veteran enthusiast to the novice overclocker the ability to unleash the hardware in their PC.

NVIDIA nTune Utility

NVIDIA nTune™ is a Windows-based utility that has added access to more settings. Adjust CPU and memory speeds without rebooting. You can also access most BIOS settings from inside Windows without having to go into the BIOS. Save and automatically load profiles for each application you run.

NV BIOS

NV BIOS delivers easy-to-use tuning to let you have full control over your hardware including processor voltage tables and memory drive strengths.

True x16 PCI Express Support

One full-bandwidth, 16-lane PCI Express link ensure maximum graphics performance for next-generation GPUs and games.

DualDDR2 Memory Architecture

A state-of-the-art Dual DDR2 memory controller allows high bandwidth and low latency data access to the CPU and GPU. Ensures data and information are relayed through the system as quickly as possible for incredible performance.

NVIDIA MediaShield™ Storage

NVIDIA MediaShield is a suite of features that safeguards your most important digital media assets; always reliable, scalable, and accessible. MediaShield includes RAID and SATA drive support.

Multiple Disk Setup

Through a simple wizard-based interface, you can effortlessly set up your drives for better data protection, faster disk access or maximum storage capacity. MediaShield automatically selects RAID 0, 1, 0+1 or 5 configurations according to your needs. Advanced users can access RAID options directly.

DiskAlert System

The event of a disk failure, MediaShield users see an image that highlights which disk has failed to make it easier to identify, replace, and recover.

RAID Morphing

MediaShield allows users to change their current RAID set-up to another configuration in a one-step process called morphing. This eliminates the need to back up data and follow multiple steps in the process.

Bootable Multidisk Array

MediaShield storage fully supports the use of multi-disk array for loading the operating system at power-up.

Networking with NVIDIA nForce

NVIDIA networking delivers the highest network throughput at the lowest CPU utilization. The manageable and stable NVIDIA networking solution results in better networking management and a lower total cost of ownership. Only NVIDIA integrates this level of networking features to allow you to take your online experience to the next level.

NVIDIA Native Gigabit Ethernet

The industry's fastest Gigabit Ethernet performance eliminates network bottlenecks and improves overall system efficiency and performance.

NVIDIA FirstPacket™ Technology

Be the 'King of Ping' with NVIDIA FirstPacket technology. Get the crystal-clear phone conversations and online gaming performance you expect. NVIDIA FirstPacket technology assures your game data, VoIP conversations, and large file transfers are delivered according to preferences set by you in an intuitive wizard.

High Definition Audio (HDA)

High definition audio brings consumer electronics quality sound to the PC delivering high quality sound from multiple channels. Using HDA, systems can deliver 192 kHz/32-bit quality for eight channels, supporting new audio formats.

USB 2.0

USB 2.0 is standard plug-and-play interface that provides easy-to-use connectivity for USB devices.

Motherboard Specifications

- ❑ Size
 - ATX form factor of 12 inch x 9.6 inch
- ❑ Microprocessor support
 - Intel Core 2 Extreme, Intel Core 2 Quad, Intel Core 2 Dual, Pentium
- ❑ Operating systems:
 - Supports Windows XP 32bit/64bit and Windows Vista 32bit/64bit
- ❑ Contains NVIDIA nForce 650i Ultra MCP and SPP
- ❑ System Memory support
 - Supports dual channel JEDEC DDR2-800. Supports up to 8 GBs DDR2 memories.
- ❑ USB 2.0 Ports
 - Supports hot plug
 - Eight USB 2.0 ports (four rear panel ports, four onboard USB headers)
 - Supports wake-up from S1 and S3 mode
 - Supports USB 2.0 protocol up to 480 Mbps transmission rate
 - 300MBps data transfer rate
 - Four Serial ATA II connectors
 - NVIDIA MediaShield RAID with support for RAID 0, RAID 1, RAID 0+1, RAID 5, and JBOD
 - Supports hot plug and NCQ (Native Command Queuing)
- ❑ Onboard LAN
 - Single LAN interface built-in onboard
 - Supports 10/100/1000 Mbit/sec Ethernet
- ❑ Audio
 - Azalia High-Definition audio
 - Supports 8-channel audio
 - Supports Jack-Sensing function

- ❑ PCI Express x16 Support
 - Supports 4 GB/sec (8 GB/sec concurrent) bandwidth
 - Low power consumption and power management features
- ❑ Green Function
 - Supports ACPI (Advanced Configuration and Power Interface)
 - Supports S0 (normal), S1 (power on suspend), S3 (suspend to RAM), S4 (Suspend to disk - depends on OS), and S5 (soft - off)
- ❑ Expansion Slots
 - Three PCI slots
 - Two PCI Express x1 slot
 - One PCI Express x16 Graphics slot



TF650i Ultra-A7 Motherboard

The TF650i Ultra-A7 motherboard with the NVIDIA nForce 650i Ultra SPP and MCP processors is a PCI Express motherboard. Figure 1 shows the motherboard and Figures 2 shows the back panel connectors.

Installing and Configuring the TF650i Ultra-A7 Motherboard

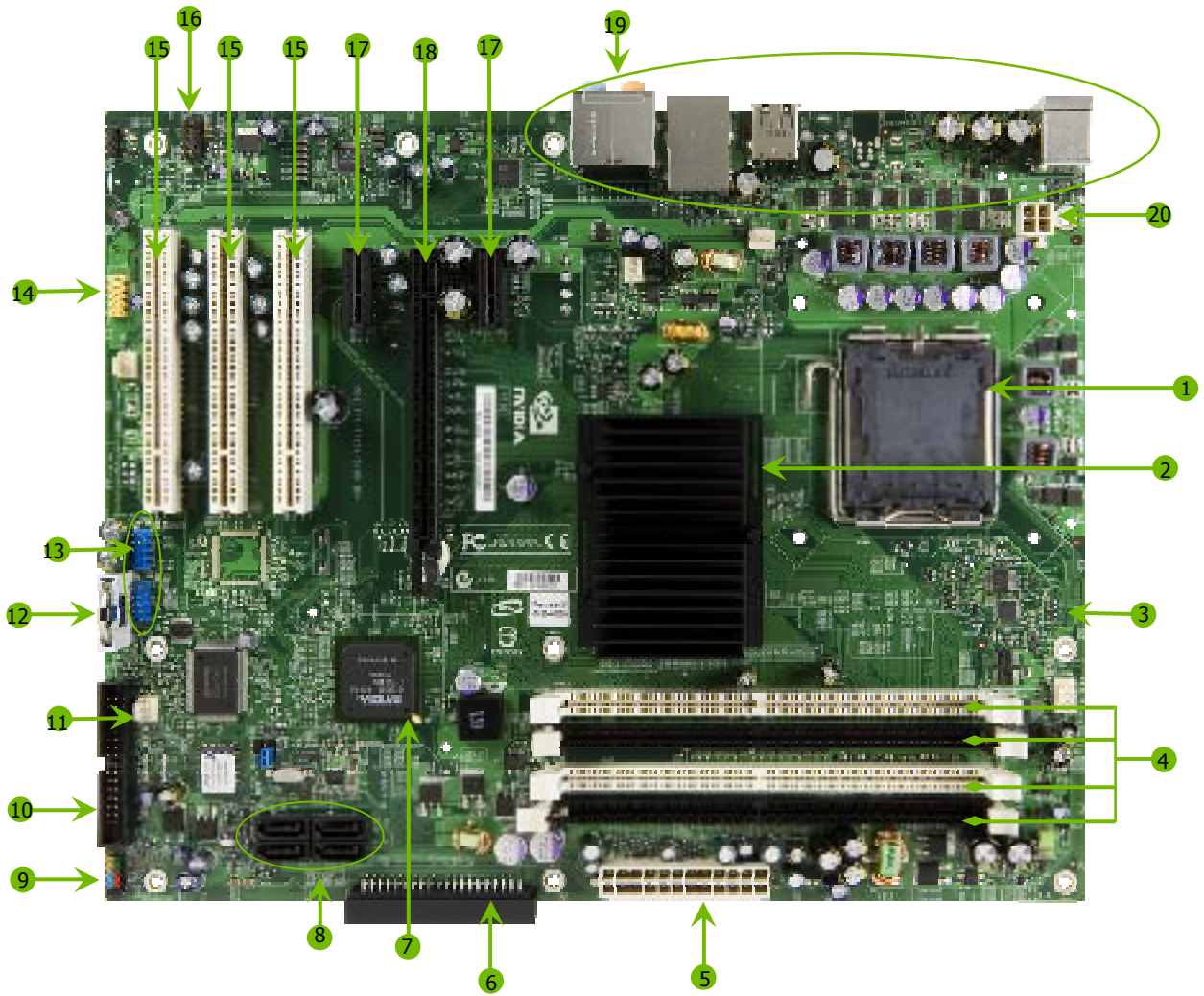

- | | | |
|-------------------------------|----------------------------|-------------------------------------|
| 1. CPU Socket | 8. Serial-ATA connectors | 15. PCI slots |
| 2. NVIDIA SPP | 9. Front panel connector | 16. Front Panel Audio connector |
| 3. CPU fan connector | 10. Floppy drive connector | 17. PCI Express x1 slot |
| 4. DDR DIMM slots 0 - 3 | 11. System fan connector | 18. PCI Express x16 slot |
| 5. 24-pin ATX power connector | 12. Motherboard battery | 19. Backpanel connectors (Figure 2) |
| 6. IDE connector | 13. USB headers | 20. 4-pin ATX_12V power connector |
| 7. NVIDIA MCP | 14. Serial connector | |

Figure 1. TF650i Ultra-A7 Motherboard Layout

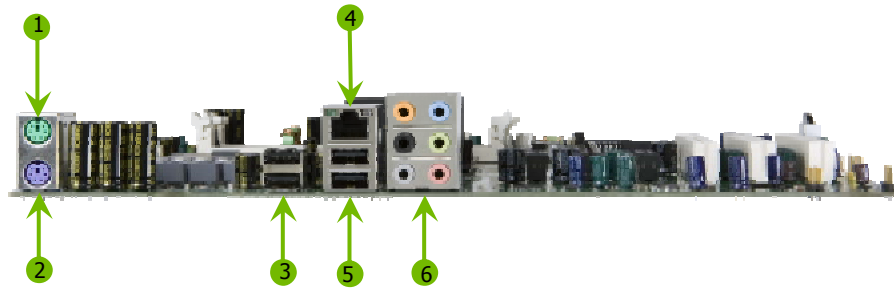

1. PS/2 Mouse Port
2. PS/2 Keyboard Port
3. USB 2.0 ports (two)
4. Lan Port with LEDs to indicate status.
 - Yellow/Light Up/Blink = 10 Mbps/Link/Activity
 - Yellow and Green/Light Up/Blink = 100 Mbps/link/Activity
 - Green/Light Up/Blink = 1000 Mbps/Link/Activity
5. USB 2.0 Ports (two)
6.

Port	2-Channel	4-Channel	6-Channel/8-Channel
Blue	Line-In	Line-In	Line-In
Green	Line-Out	Front Speaker Out	Front Speaker Out
Pink	Mic In	Mic In	Mic In
Orange			Center/Subwoofer
Black		Rear Speaker Out	Rear Speaker Out
Grey			

Figure 2. Chassis Backpanel Connectors



Hardware Installation

This section will guide you through the installation of the motherboard. The topics covered in this section are:

- ❑ Preparing the motherboard
 - Installing the CPU
 - Installing the CPU fan
 - Installing the memory
- ❑ Installing the motherboard
- ❑ Connecting cables and setting switches

Safety Instructions

To reduce the risk of fire, electric shock, and injury, always follow basic safety precautions.

Remember to remove power from your computer by disconnecting the AC main source before removing or installing any equipment from/to the computer chassis.

Preparing the Motherboard

The motherboard shipped in the box does *not* contain a CPU or memory. You need to purchase a CPU, a CPU fan assembly, and memory to complete this installation.

Installing the CPU

Be very careful when handling the CPU. Make sure not to bend or break any pins on the back. Hold the processor only by the edges and do not touch the bottom of the processor.

Use the following procedure to install the CPU onto the motherboard.

1. Unhook the socket lever by pushing *down* and *away* from the socket.
2. Lift the load plate. There is a protective socket cover on the load plate to protect the socket when there is no CPU installed.
3. Remove the protective socket cover from the load plate.
4. Remove the processor from its protective cover, making sure you hold it only by the edges. It is a good idea to save the cover so that whenever you remove the CPU, you have a safe place to store it.
5. Align the notches in the processor with the notches on the socket.
6. Lower the processor straight down into the socket with out tilting or sliding it into the socket

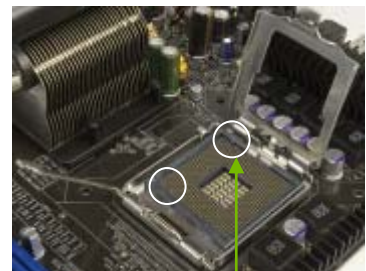
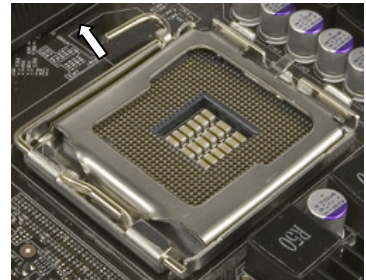

Align notches with notches on the CPU

Note: Make sure the CPU is fully seated and level in the socket.



7. Close the load plate over the CPU and press down while you close and engage the socket lever.

Installing the CPU Fan

There are many different fan types that can be used with this motherboard. Follow the instruction that came with you fan assembly. Be sure that the fan orientation is correct for your chassis type and your fan assembly.

Installing Memory DIMMs

Your new motherboard has four 1.8V 240-pin slots for DDR2 memory. These slots support 256 Mb, 512 Mb and 1 Gb DDR2 technologies for x8 and x16 devices. They also support dual channel DDR2 memory technology up to 10.7GB/s. There must be at least one memory bank populated to ensure normal operation. Use the following the recommendations for installing memory. (See Figure 1 on page 8 for the location of the memory slots on the card)

- ❑ One DIMM: Install into slot 0. You can install the DIMM into any slot, however, slot 0 is preferred.
- ❑ Two DIMMs: Install into either slots 0 and 1 or 2 and 3. The idea is to not have the DIMMs in adjacent slots.
- ❑ Four DIMMS: Install into slots 0, 1, 2, and 3.

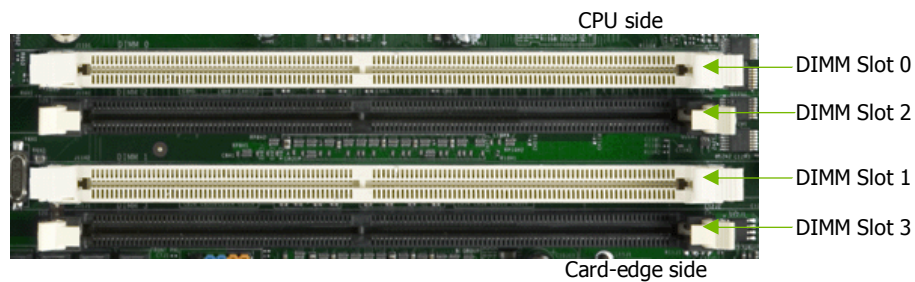

Use the following procedure to install memory DIMMs into the slots on the motherboard. Note that there is only one gap near the center of the DIMM slot. This slot matches the slot on the memory DIMM to ensure the component is installed properly.

1. Unlock a DIMM slot by pressing the module clips outward.
2. Align the memory module to the DIMM slot, and insert the module vertically into the DIMM slot. The plastic clips at both sides of the DIMM slot automatically lock the DIMM into the connector.

Installing the Motherboard

The sequence of installing the motherboard into the chassis depends on the chassis you are using and if you are replacing an existing motherboard or working with an empty chassis. Determine if it would be easier to make all the connections prior to this step or to secure the motherboard and then make all the connections. Use the following procedure to install the I/O shield and secure the motherboard into the chassis.

Note: Be sure that the CPU fan assembly has enough clearance for the chassis covers to lock into place and for the expansion cards. Also make sure the CPU Fan assembly is aligned with the vents on the covers.

Installing the I/O Shield

The motherboard kit comes with an I/O shield that is used to block radio frequency transmissions, protects internal components from dust and foreign objects, and promotes correct airflow within the chassis.

Before installing the motherboard, install the I/O shield from the *inside* of the chassis. Press the I/O shield into place and make sure it fits securely. If the I/O shield does not fit into the chassis, you would need to obtain the proper size from the chassis supplier.

Securing the Motherboard into the Chassis

Most computer chassis have a base with mounting studs or spacers to allow the mother board to be secured to the chassis and help to prevent short circuits. If there are studs that do not align with a mounting hole on the motherboard, it is recommended that you remove that stud to prevent the possibility of a short circuit.

1. Carefully place the motherboard onto the studs/spacers located inside the chassis.
2. Align the mounting holes with the studs/spacers.
3. Align the connectors to the I/O shield.
4. Ensure that the fan assembly is aligned with the chassis vents according to the fan assembly instruction.
5. Secure the motherboard with a minimum of eight-to-ten screws.

Connecting Cables and Setting Switches

This section takes you through all the connections and switch settings necessary on the motherboard. This will include:

- ❑ Power Connections
 - 24-pin ATX power (**PWR1**)
 - 4-pin ATX 12V power (**PWR2**)
- ❑ Internal Headers
 - Front panel
 - USB Headers
 - Audio
 - COM
- ❑ FDD
- ❑ IDE
- ❑ Serial ATA II
- ❑ Chassis Fans
- ❑ Rear panel USB 2.0 Adapter
- ❑ Expansion slots
- ❑ CMOS jumper settings

See Figure 1 on page 8 to locate the connectors and jumpers referenced in the following procedure.

Power Connections

This motherboard requires an ATX power supply. Make sure you have enough power to cover all the expansion cards you will be installing. To determine what you power requirements are for your specific configuration, refer to www.slizone.com.

24-pin ATX Power (PWR1)

PWR1 is the main power supply connector located along the edge of the board next to the DIMM slots. Make sure that the power supply cable and pins are properly aligned with the connector on the motherboard. Firmly plug the power supply cable into the connector and make sure it is secure.



PWR1 connector
Plug power cable from system power supply to PWR1

Figure 3. PWR1 Motherboard Connector

Table 1. PWR1 Pin Assignments

Connector	Pin	Signal	Pin	Signal
	1	+3.3V	13	+3.3V
	2	+3.3V	14	-12V
	3	GND	15	GND
	4	+5V	16	PS_ON
	5	GND	17	GND
	6	+5V	18	GND
	7	GND	19	GND
	8	PWROK	20	RSVD
	9	+5V_AUX	21	+5V
	10	+12V	22	+5V
	11	+12V	23	+5V
	12	+3.3V	24	GND

4-pin ATX 12V Power (PWR2)

PWR2, the 4-pin ATX 12V power connection, is used to provide power to the CPU. Align the pins to the connector and press firmly until seated.

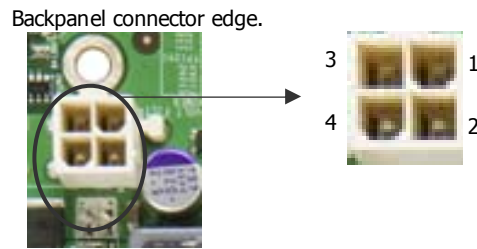

Connecting IDE Hard Disk Drives

The IDE connector supports Ultra ATA 133/100/66 IDE hard disk drives.

1. Connect the blue connector (the cable end with a single connector) to the motherboard.
2. Connect the black connector (the cable with the two closely spaced black and gray connectors) to the Ultra ATA master device.
3. Connect the gray connector to a slave device.

If you install two hard disk drives, you must configure the second drive as a slave device by setting its jumper accordingly. Refer to the hard disk documentation for the jumper settings.

Note: If an ATA-66/100 disk drive and a disk drive using any other IDE transfer protocol are attached to the same cable, the maximum transfer rate between the drives may be reduced to that of the slowest drive.

Connecting Serial ATA Cables

The Serial ATA II connector is used to connect the Serial ATA II device to the motherboard. These connectors support the thin Serial ATA II cables for primary storage devices. The current Serial ATA II interface allows up to 300MB/s data transfer rate.

There are four serial ATA connectors on the motherboard that support RAID 0, RAID 1, RAID 5, RAID 0+1 and JBOD configurations.

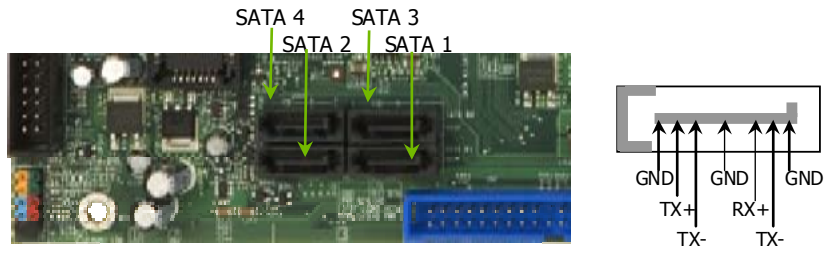

1. Connect the locking cable end to the motherboard connector.
2. Connect the end without the lock to the drive.

Connecting Internal Headers

Front Panel Header

The front panel header on this motherboard is one connector used to connect the following four cables:



❑ PWRLED

Attach the front panel power LED cable to these two pins of the connector.

The Power LED indicates the system's status. When the system is in S0 status, the LED is on. When the system is in S1, S3, S4, S5 status, the LED is off.

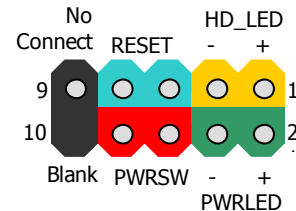

Note: The power LED cable in some chassis is a three pin connector with the pins installed in positions 1 and 3. If your chassis has a three pin connector, you will need to remove pin 3 and put it into position 2 or you can use a pair of scissors to cut out position 2. Most chassis come with a two pin connector.

❑ PWRSW

Attach the power button cable from the case to these two pins. Pressing the power button on the front panel turns the system on off rather than using the power supply button.

❑ HD_LED

Attach the hard disk drive indicator LED cable to these two pins. The HDD indicator LED indicates the activity status of the hard disks.

❑ RESET

Attach the Reset switch cable from the front panel of the case to these two pins. The system restarts when the **RESET** switch is pressed.

Table 2. Front Panel Header Pins

	Pin	Signal	In/Out	Description
HD_LED	1	HD_PWR	Out	Hard disk LED pull-up to +5V
	3	HDA#	Out	Hard disk active LED
PWRLED	2	HDR_BLNK_GRN	Out	Front panel green light
	4	HDR_BLNK_YEL	Out	Front panel yellow light
RESET	5	GND		Ground
	7	FP_RESET#	In	Reset switch
PWRSW	6	SWITCH_ON#	In	Power switch
	8	GND		Ground
No Connect	9	No Connect		
Empty	10	Empty		

USB Headers

This motherboard contains four (4) USB 2.0 ports that are exposed on the rear panel of the chassis. The motherboard also contains two 10-pin internal header connectors onboard that can be used to connect an optional external bracket containing four (4) more USB 2.0 ports.



1. Secure the bracket to either the front or rear panel of your chassis (not all chassis are equipped with the front panel option).
2. Connect the two ends of the cables to the USB 2.0 headers on the motherboard.

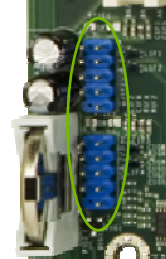

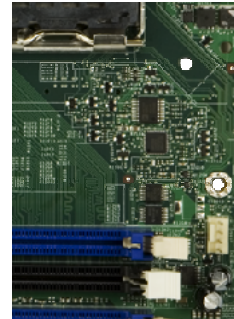
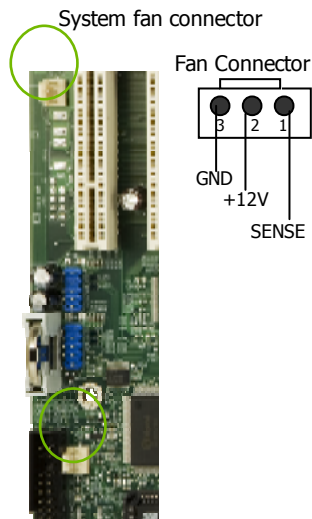

Table 3. USB 2.0 Header Pins

Connector	Pin	Signal	Pin	Signal
	1	5V_DUAL	2	5V_DUAL
	3	D-	4	D-
	5	D+	6	D+
	7	GND	8	GND
	9	Empty	10	No Connect

Fan Connections

There are two fan connections, the system fan and the CPU fan. The fan speed can be detected and viewed in the **PC Health Status** section of the CMOS Setup. Both fans are automatically turned off after the system enters S3, S4 and S5 mode.



Note that the CPU fan cable can be either a 3-pin or a 4-pin connector. Connect a 3-pin connector to pins 1, 2, and 3 on the motherboard connector.

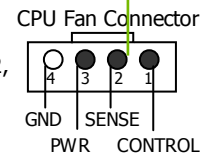

COM1

The motherboard kit provides an additional serial COM header for your machine. Connect one side of a switching cable to the header and then attach the serial COM device to the other side of the cable.

FDD Connector

The motherboard supports a standard 360K, 720K, 1.2M, 1.44m, and a 2.88M floppy disk drive (FDD).

Expansion Slots

The TF650i Ultra-A7 motherboard contains six expansion slots, one PCI Express slot and three PCI slots. For a full list of PCI Express x16 graphics card supported by this motherboard, go to www.nvidia.com/estore.

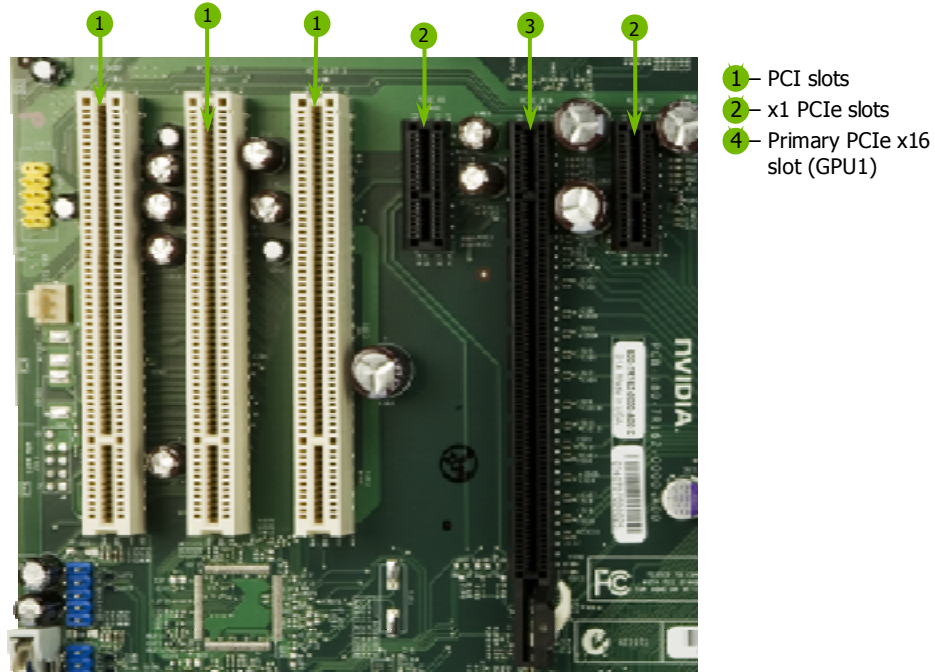

Figure 4. Expansion Slots

PCI Slots

The three PCI slots support many expansion cards such as a LAN card, USB card, SCSI card and other cards that comply with PCI specifications. When installing a card into the PCI slot, be sure that it is fully seated. Secure the card's metal bracket to the chassis back panel with the screw used to hold the blank cover.

PCI Express x1 Slot

There are two PCI Express x1 slots that are designed to accommodate less bandwidth-intensive cards, such as a modem or LAN card. The x1 slot provides 250 MB/sec bandwidth.

PCI Express x16 Slots

There is one PCI Express x16 slot that is reserved for a graphics or video card. The bandwidth of the x16 slot is up to 4GB/sec (8GB/sec concurrent).

When installing a PCI Express x16 card, be sure the retention clip snaps and locks the card into place. If the card is not seated properly, it could cause a short across the pins. Secure the card's metal bracket to the chassis back panel with the screw used to hold the blank cover.

Jumper Settings

The motherboard contains a 3-pin BIOS configuration jumper that enables all board configurations to be done in the BIOS Setup program.

The silk screen on the motherboard shows a Δ next to pin 1.

Clear CMOS Jumper: CLR_CMOS

The motherboard uses the CMOS RAM to store all the set parameters. The CMOS can be cleared by removing the CMOS jumper.

Use the following procedure to clear CMOS:

1. Turn off the AC power supply and connect pins 1 and 2 together using the jumper cap.
2. Return the jumper setting to normal (pins 2 and
3. Together with the jumper cap).
4. Turn the AC power supply back on.



Configuring the BIOS

This section discusses how to change the system settings through the BIOS Setup menus. Detailed descriptions of the BIOS parameters are also provided.

This section includes the following information:

- ❑ Enter BIOS Setup
- ❑ Main Menu
- ❑ Standard CMOS Features
- ❑ Advanced BIOS Features
- ❑ Advanced Chipset Features
- ❑ Integrated Peripherals
- ❑ Power Management Setup
- ❑ PnP/PCI Configurations
- ❑ System Monitor

Enter BIOS Setup

The BIOS is the communication bridge between hardware and software. Correctly setting the BIOS parameters is critical to maintain optimal system performance.

Use the following procedure to verify/change BIOS settings.

1. Power on the computer,
2. Press the **Del** key when the following message briefly displays at the bottom of the screen during the Power On Self Test (POST).

Press F1 to continue, DEL to enter Setup.

Pressing **Del** takes you to the Phoenix-Award BIOS CMOS Setup Utility.

Note: It is *strongly* recommended that you do not change the default BIOS settings. Changing some settings could damage your computer.

Main Menu

The main menu allows you to select from the list of setup functions and two exit choices. Use the **Page Up** and **Page Down** keys to scroll through the options or press **Enter** to display the associated submenu. Use the **↑↓** arrow keys to position the selector in the option you choose. To go back to the previous menu, press **Esc**.

Note: Note that on the BIOS screens all data in **white** is for information only, data in **yellow** is changeable, data in **blue** is non-changeable, and data in a **red box** is highlighted for selection.

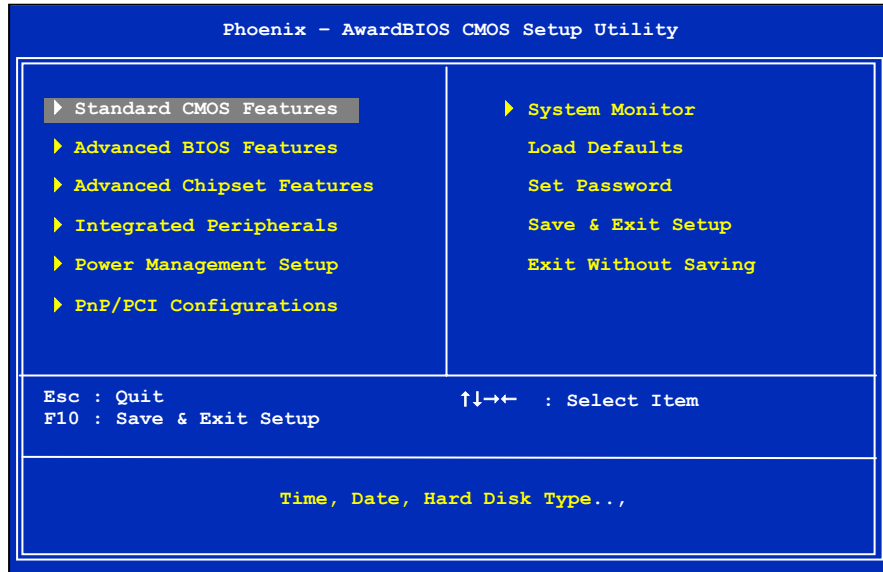

Figure 5. BIOS CMOS Setup Utility Main Menu

- ❑ **Standard CMOS Features**
Use this menu to set up the basic system configuration.
- ❑ **Advanced BIOS Features**
Use this menu to set up the advanced system features and boot sequence.
- ❑ **Advanced Chipset Features**
Use this menu to optimize system performance and configure clocks, voltages, memory timings, and more.
- ❑ **Integrated Peripherals**
Use this menu to set up onboard peripherals such as IDE, RAID, USB, LAN, and MAC control.
- ❑ **Power Management Setup**
Use this menu to configure power management, power on, and sleep features.
- ❑ **PnP/PCI Configurations**
Use this menu to modify the system's Plug-and-Play and PCI configurations.
- ❑ **System Monitor**
Use this menu to monitor the real-time system status of your PC, including temperature, voltages, and fan speed.

The following items on the CMOS Setup Utility main menu are commands rather than submenus:

- ❑ **Load Defaults**
Load default system settings.
- ❑ **Set Password**
Use this command to set, change, and disable the password used to access the BIOS menu.
- ❑ **Save & Exit Setup**
Use this command to save settings to CMOS and exit setup.
- ❑ **Exit Without Saving**
Use this command to abandon all setting changes and exit setup.

The following two items on the CMOS Setup Utility main menu are status indicators:

Standard CMOS Features Menu

The Standard CMOS Features menu is used to configure the standard CMOS information, such as the date, time, HDD model, and so on. Use the **Page Up** and **Page Down** keys to scroll through the options or press **Enter** to display the sub-menu. Use the **↑↓** arrow keys to position the selector in the option you choose. To go back to the previous menu, press **Esc**.

The information shown in **Item Help** corresponds to the option highlighted.

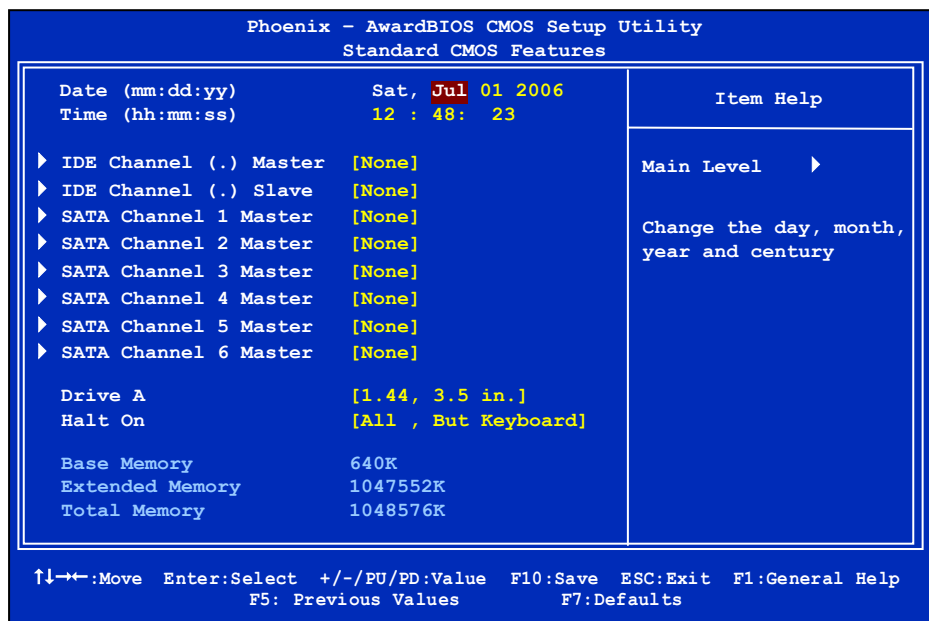

Figure 6. Standard CMOS Features Menu

Note: Note that all data in **white** is for information only, data in **yellow** is changeable, data in **blue** is non-changeable, and data in a **red box** is highlighted for selection.

Date and Time

Using the arrow keys, position the cursor over the month, day, and year. Use the **Page Up** and **Page Down** keys to scroll through dates and times. Note that the weekday (Sun through Sat) cannot be changed. This field changes to correspond to the date you enter. Note that the hour value is shown in a 24-hour clock format. Time is represented as **hour : minute : second**

```
Date (mm:dd:yy)      Sat, Jul 01 2006
Time (hh:mm:ss)     14 : 48 : 43
```

IDE Channel and SATA Channel

Use these functions to detect and configure the individual IDE and SATA channels. Select a channel and press **Enter** to display the IDE/SATA sub-menu.

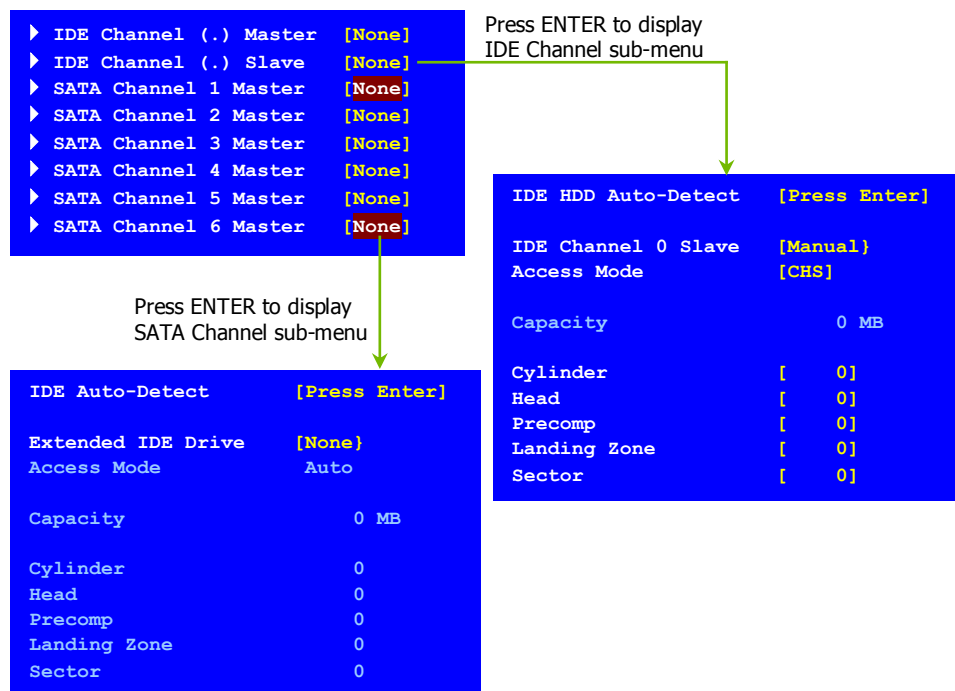

Press **Enter** to auto-detect IDE and SATA channels in the system. Once the channel is detected, the values for Capacity, Cylinder, Heads, Precomp, Landing Zone, and Sector are automatically filled in.

❑ **None**

There is no HDD installed or set.

❑ **Auto**

The system can auto-detect the hard disk when booting up.

❑ **Manual**

When you set the channel to **[Manual]** and change **Access Mode** to **[CHS]**, you can then enter the number of cylinders, heads, Precomp, landing zone, and sector. You can manually enter the values or you can press **Enter** to display a window that tells you the min and max values.

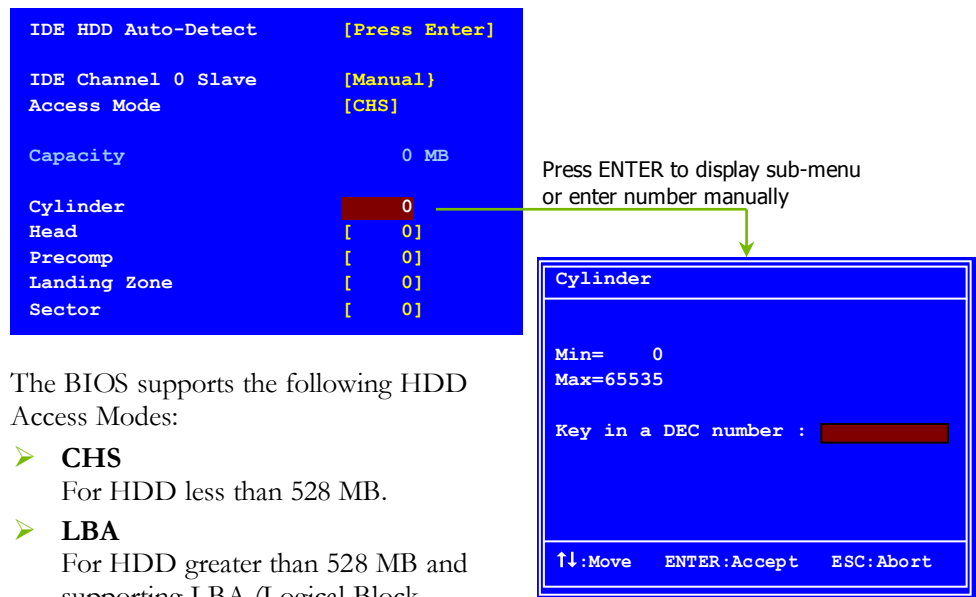

The BIOS supports the following HDD Access Modes:

- **CHS**
For HDD less than 528 MB.
- **LBA**
For HDD greater than 528 MB and supporting LBA (Logical Block Addressing).
- **Large**
For HDD greater than 528 MB but not supporting LBA.
- **Auto**
Recommended mode.

Drive A

The **Drive A** option allows you to select the kind of FDD to install.

Options are:

```
Drive A      [1.44, 3.5 in.]
Halt On     [All , But Keyboard]
```

Press ENTER to display sub-menu

- None
- 360K, 5.25 in.
- 1.2M, 5.25 in.
- 720K, 3.5 in.
- 1.44M, 3.5 in.
- 2.88M, 3.5 in.

Use the **Page Up** and **Page Down** keys to scroll through the options or press **Enter** to display the sub-menu. Use the **↑↓** arrow keys to position the selector in the option you choose. Press **Enter** to accept the changes and return to the Standard CMOS Features menu.

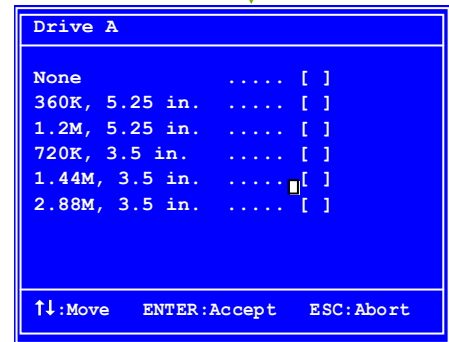

Halt On

Halt On determines whether or not the computer stops if an error is detected during power on. Use the **Page Up** and **Page Down** keys to scroll through the options or press **Enter** to display the **Halt On** sub-menu. Use the **↑↓** arrow keys to position the selector in the option you choose. Press **Enter** to accept the changes and return to the Standard CMOS Features menu.

```
Drive A      [1.44, 3.5 in.]
Halt On     [All , But Keyboard]
```

Press ENTER to display sub-menu

- All Errors**
Whenever the BIOS detects a nonfatal error, the system stops and prompts you.
- No Errors**
System boot does not stop for any detected errors.
- All, But Keyboard**
System boot does not stop for keyboard errors, but does stop for all other errors.

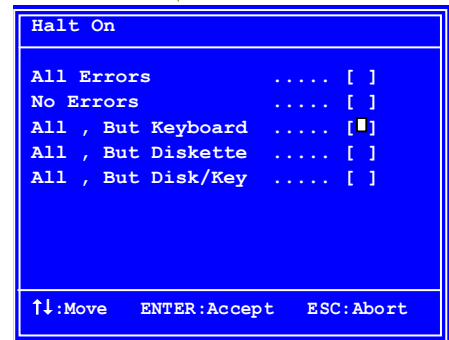

❑ **All, But Diskette**

The system boot does not stop for a diskette error but will stop for all other errors.

❑ **All, But Disk/Key**

The system boot does not stop for a keyboard or disk error, but will stop for all other errors.

Memory

These settings are *display-only values* that are determined by the BIOS POST (Power-On Self Test).

Base Memory	640K
Extended Memory	1047552K
Total Memory	1048576K

❑ **Base Memory**

BIOS POST determines the amount of base (or conventional) memory installed in the system.

❑ **Extended Memory**

BIOS determines how much extended memory is present during the POST.

❑ **Total Memory**

This value represents the total memory of the system.

Advanced BIOS Features

Access the Advanced BIOS Features menu from the CMOS Utility Setup screen. Use the **Page Up** and **Page Down** keys to scroll through the options or press **Enter** to display the sub-menu. Use the **↑↓** arrow keys to position the selector in the option you choose. To go back to the previous menu, press **Esc**.

Note: The options that have associated sub-menus are designated by a **▶**, which precedes the option. Press **Enter** to display the sub-menus.

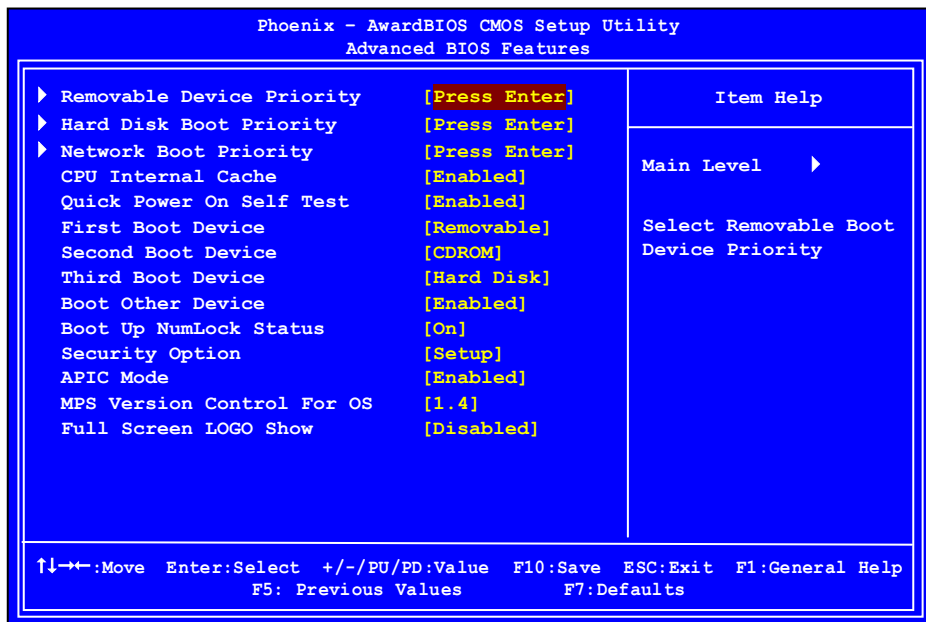

Figure 7. Advanced BIOS Features Menu

Note: Note that all data in **white** is for information only, data in **yellow** is changeable, data in **blue** is non-changeable, and data in a **red box** is highlighted for selection.

Removable Device Priority

Use this option to select the priority for removable device startup. Press **Enter** to see the list of removable devices in your system. Use the **↑↓** arrow keys to go to the various devices. Then use the **+** or **-** keys to move the device priority up or down in the list. To go back to the previous menu, press **Esc**.

```
1. Floppy Disks
```

Hard Disk Boot Priority

Use this option to select the priority for HDD startup. Press **Enter** to see the list of bootable devices in your system. Use the **↑↓** arrow keys to go to the various devices. Then use the **+** or **-** keys to move the device priority up or down in the list. To go back to the previous menu, press **Esc**.

```
1. Ch0. : ST3802110A
2. Bootable Add-in Cards
```

Use the **+** and **-** keys to move the priority of the device within the list

Network Boot Priority

Use this option to select the priority for network startup. Select **Network Boot Priority** and press **Enter** to view available networks. Use the **↑↓** arrow keys to go to the various devices. Then use the **+** or **-** keys to move the device priority up or down in the list. To go back to the previous menu, press **Esc**.

```
1. Network 0 : <description of network>
2. Network 1 : <description of network>
```

CPU Internal Cache

Use this option to enable or disable the CPU internal cache. Use the **Page Up** and **Page Down** keys to scroll through the options or press **Enter** to display the options in a sub-menu. Use the **↑↓** arrow keys to position the selector in the option you choose.

Quick Power On Self Test

Enabling this option allows the system to skip certain test while booting, which reduces the time needed to boot the system. Use the **Page Up** and **Page Down** keys to toggle between **Enable** and **Disable**.

First/Second/Third Boot Device

Use this option to set the priority sequence of the devices booted at power on. Use the **Page Up** and **Page Down** keys to scroll through the options or press **Enter** to display the sub-menu. Use the **↑↓** arrow keys to position the selector in the option you choose.

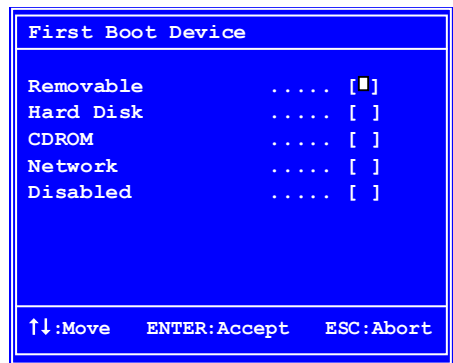

Boot Other Device

With the option set to **Enable**, the system boots from some other device if the first/second/third boot devices fail.

Boot Up NumLock Status

This option allows you to select the power-on state of **NumLock**. Select **On** to activate the keyboard **NumLock** when the system is started. Select **Off** to disable the **NumLock** key.

Security Option

The Security Options allows you to require a password every time the system boots or only when you enter setup. Select **Setup** to require a password to gain access to the CMOS Setup screen. Select **System** to require a password to access the CMOS Setup screen and when the system boots.

APIC Mode

Use this function to enable or disable the Advanced Programmable Interrupt Controller (APIC). If you disable this option, you also disable the MPS Version Control for OS option.

MPS Version Control For OS

Use this function to select the Multi-Processor Specification (MPS) version that BIOS passes to the operating system. Use the **Page Up** and **Page Down** keys to scroll through the options.

Full Screen LOGO Show

This option allows you to enable or disable the display of the full-screen logo when the system boots. Use the **Page Up** and **Page Down** keys to toggle between **Enable** and **Disable**

Advanced Chipset Features

Select **Advanced Chipset Features** from the CMOS Setup Utility menu and press **Enter** to display the functions of the Advanced Chipset Functions menu.

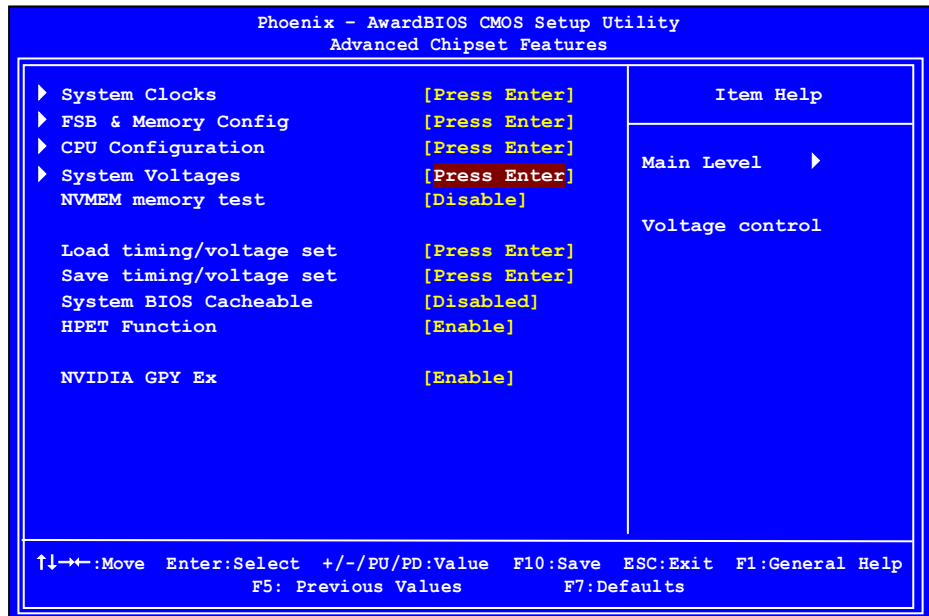

Figure 8. Advanced Chipset Features

System Clocks

Select **System Clocks** from the Advanced Chipset Features menu and press **Enter** to display the System Clocks menu. From this menu, you are able to specify frequency settings, HT multipliers, and Spread Spectrum settings. Note that in Figure 9, all of the options are listed. On the actual BIOS screen, you will need to scroll down to see all the options.

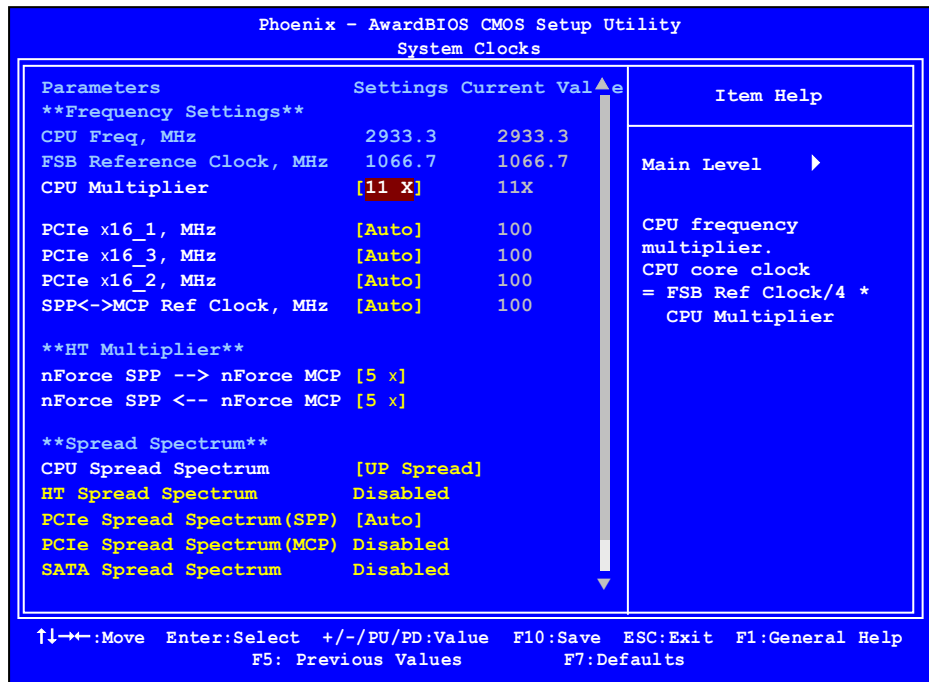

Figure 9. System Clocks Menu

Note: Note that all data in **white** is for information only, data in **yellow** is changeable, data in **blue** is non-changeable, and data in a **red box** is highlighted for selection.

Frequency Settings

- ❑ **CPU Freq, MHz**
This value is set by the CPU Multiplier (value cannot be changed by the user).
- ❑ **FSB Reference Clock, MHz**
This value is set by the system (value cannot be changed by the user). To change the FSB memory, and memory timing, go to the FSB & Memory screen.
- ❑ **CPU Multiplier**
This value changes the CPU Frequency value depending on the value you choose. Use the **Page Up** and **Page Down** keys to scroll through the options. The options are from 6 X through 60 X.
- ❑ **PCIe x16_1, MHz**
Use the **Page Up** and **Page Down** keys to scroll through the frequency options for the PCI Express Bus, Slot 1 (the black slot closest to the CPU). Note that as you go higher in value, **PCIe Spread Spectrum (SPP)** is disabled and cannot be changed from this status.
- ❑ **PCIe x16_3, MHz**
Use the **Page Up** and **Page Down** keys to scroll through the frequency options for the PCI Express Bus, Slot 3 (the blue slot in the middle).
- ❑ **PCIe x16_2, MHz**
Use the **Page Up** and **Page Down** keys to scroll through the frequency options for the PCI Express Bus, Slot 3 (the black slot farthest from the CPU).
- ❑ **SPP<—>MCP Ref Clock, MHz**
Use the **Page Up** and **Page Down** keys to scroll through the frequency options for the reference clock between the SPP chip and the MCP chip.

HT Multiplier

- ❑ **nForce SPP → nForce MCP**
Use the **Page Up** and **Page Down** keys to scroll through the HT multiplier options and set the link speed from the SPP chip to the MCP chip. Values are [1 x] through [5 x].
- ❑ **nForce MCP ← nForce SPP**
Use the **Page Up** and **Page Down** keys to scroll through the HT multiplier options and set the link speed from the MCP chip to the SPP chip. Values are [1 x] through [5 x].

Spread Spectrum

- ❑ **CPU Spread Spectrum**
Use the **Page Up** and **Page Down** keys to scroll through the Spread Spectrum options for the CPU. Option values are [Disabled], [UP Spread], and [Center Spread].
- ❑ **HT Spread Spectrum**
Disabled
- ❑ **PCIe Spread Spectrum (SPP)**
Use the **Page Up** and **Page Down** keys to scroll through the Spread Spectrum options for the SPP PCIe. Option values are [Disabled], [UP Spread], and [Center Spread]. This option reverts to **Disabled** and cannot be changed when the value for PCIe x16_1 exceeds 100MHz.
- ❑ **PCIe Spread Spectrum(MCP)**
Disabled
- ❑ **SATA Spread Spectrum**
Disabled

FSB & Memory Config

Select **FSB & Memory Config** from the Advanced Chipset Features menu and press **Enter** to display the FSB & Memory Config menu. This menu provides the means to set FSB and memory timing.

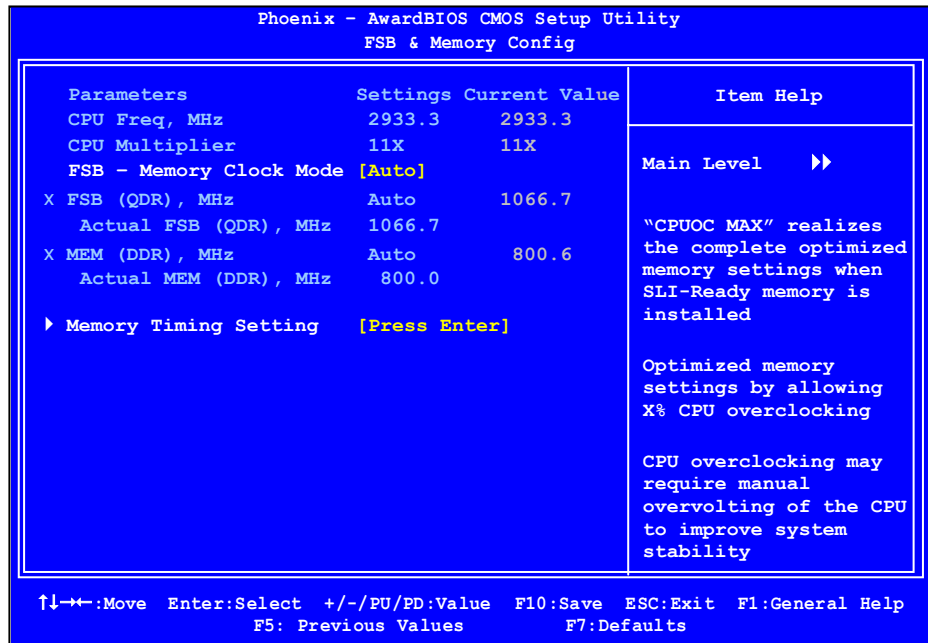

Figure 10. FSB & Memory Config Menu

❑ FSB and Memory Clock Mode

Use the **Page Up** and **Page Down** keys to scroll through the FSB and Memory Clock Mode options. The options are:

- **Auto**
This is the optimal setting since it sets the FSB and memory speeds automatically.
- **Linked**
When **Link** is selected, **FSB (QDR), MHz** is changed to editable and the FSB speed can be entered manually. As the FSB speed is changed, **CPU Freq, MHz** changes proportionally.

CPU Freq, MHz	2933.3	2933.3
CPU Multiplier	11X	11X
FSB - Memory Clock Mode	[Linked]	
FSB (QDR), MHz	[1067]	1066.7
Actual FSB (QDR), MHz	1066.7	
X MEM (DDR), MHz	Auto	800.6
Actual MEM (DDR), MHz	800.0	

➤ **Unlinked**

When **Unlink** is selected, **FSB (QDR), MHz** and **MEM (DDR), MHz** are changed to editable and the FSB and memory speeds can be entered manually. As the FSB speed is changed, **CPU Freq, MHz** changes proportionally.

FSB - Memory Clock Mode	[Linked]	
FSB (QDR), MHz	[1067]	1066.7
Actual FSB (QDR), MHz	1066.7	
MEM (DDR), MHz	[1067]	800.6
Actual MEM (DDR), MHz	800.0	

❑ **FSB (QDR), MHz**

Use the **+** or **-** keys to scroll through new values for the CPU FSB frequency or type in a new value. Note that the **Actual FSB (QDR)** reflects the actual frequency that takes effect on a reboot.

❑ **MEM (DDR), MHz**

Use the **+** or **-** keys to scroll through new values for the memory frequency or type in a new value. Note that the **Actual MEM (DDR)** reflects the actual frequency that takes effect when the system reboots.

❑ **Memory Timing Setting**

Press **Enter** to display the Memory Timing Setting menu. Use this menu to set optimal timings or to manually enter timings.

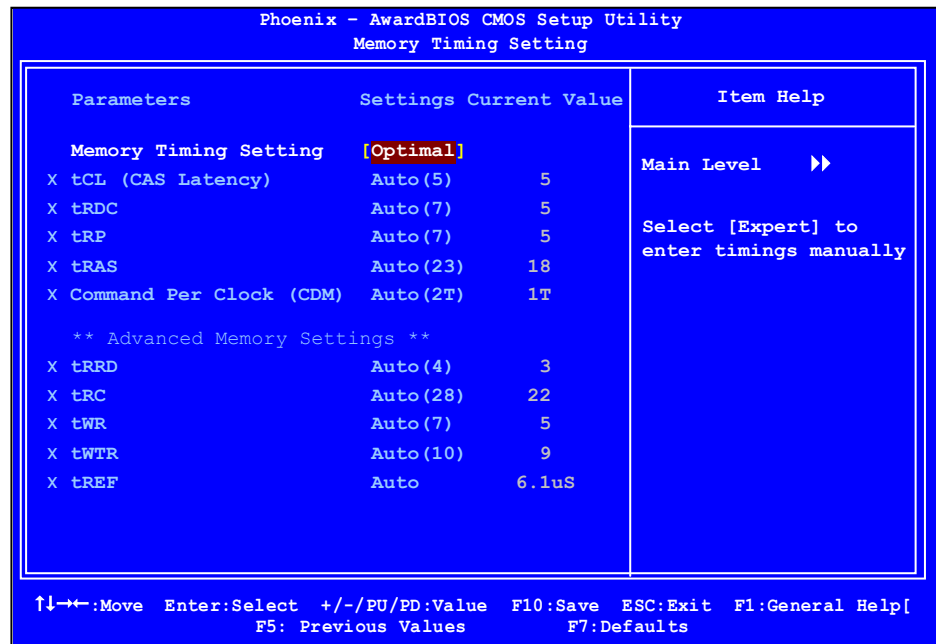

➤ **Optimal**

Use the **Page Up** and **Page Down** keys to select **Optimal**. Optimal prohibits you from manually setting any timing. All timing is set for optimal performance.

➤ **Expert**

Use the **Page Up** and **Page Down** keys to select **Expert**. When Expert is selected, all timing categories are enabled for manual input. Note that you should set the value to Optimal to use the manufacturers' recommended values.

Parameters	Settings	Current Value
Memory Timing Setting	[Expert]	
tCL (CAS Latency)	[Auto (5)]	5
tRDC	[Auto (7)]	5
tRP	[Auto (7)]	5
tRAS	[Auto (23)]	18
Command Per Clock (CDM)	[Auto (2T)]	1T
** Advanced Memory Settings **		
tRRD	[Auto (4)]	3
tRC	[Auto (28)]	22
tWR	[Auto (7)]	5
tWTR	[Auto (10)]	9
tREF	[Auto]	6.1uS

- ↵ **tCL**: CAS# latency (options are 1 through 6).
- ↵ **tRDC**: RAS#-to-CAS# Delay for Read/Write commands to the same bank (options are 1 through 7).
- ↵ **tRP**: Row Precharge time. This is the Precharge-to-Active or Auto-to-Refresh of the same bank (options are 1 through 7).
- ↵ **tRAS**: This is the minimum RAS# active time (options are 1 through 31).
- ↵ **Command Per Clock**: This is the command timing setting on a per clock unit basis (options are 1T and 2T).
- ↵ **tRRD**: RAS#-to-RAS# delay of different banks (options are 1 through 15).
- ↵ **tRC**: RAS#-to-RAS# or auto refresh time of the same bank (options are 1 through 31).
- ↵ **tWR**: The Write recovery time (options are 2 through 7).
- ↵ **tWTR**: This is the minimum write-to-read delay with the same chip selected (options are 1 through 10).
- ↵ **tREF**: This is the DRAM refresh rate (options are **Auto**, **7.8uS**, and **3.9uS**).

CPU Configuration

Select **CPU Configuration** from the Advanced Chipset Features menu and press **Enter** to display the CPU Configuration menu.

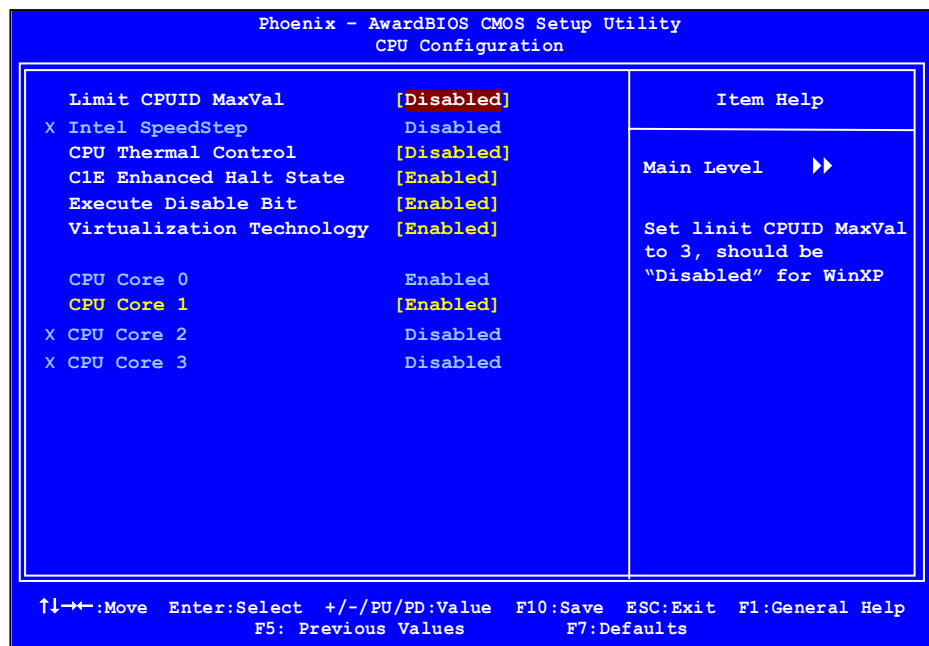

Figure 11. CPU Configuration Menu

□ Limit CPUID MaxVal

Use this function to enable the set limit of the CPUID MaxVal to 3. Set to Disable for Win XP.

□ CPU Thermal Control

Use this function to enable or disable TM1 and TM2 support. The options are:

- Disable
Disable support for TM1 and TM2.
- TM1 Only
The CPU is thermally throttled by cutting active processor clock cycles.
- TM2 Only
Thermal throttling is achieved by reducing the CPU multiplier and CPU core voltage.

- **TM1 & TM2**
Enables support for both TM1 and TM2.
- ❑ **C1E Enhanced Halt State**
Enabled, this function reduces the CPU power consumption when the CPU is idle. Idle occurs when the operating system issues a halt instruction.
- ❑ **Execute Disable Bit**
When this function is disabled, it forces the XD feature flag to always return to zero (0).
- ❑ **Virtualization Technology**
When this function is enabled, it allows a VMM to utilize the additional hardware capabilities provided by Intel Virtualization Technology.
- ❑ **CPU Core 1**
This function allows you to enable or disable CPU Core.

System Voltages

Select **System Voltages** from the Advanced Chipset Features menu and press **Enter** to display the System Voltages menu.

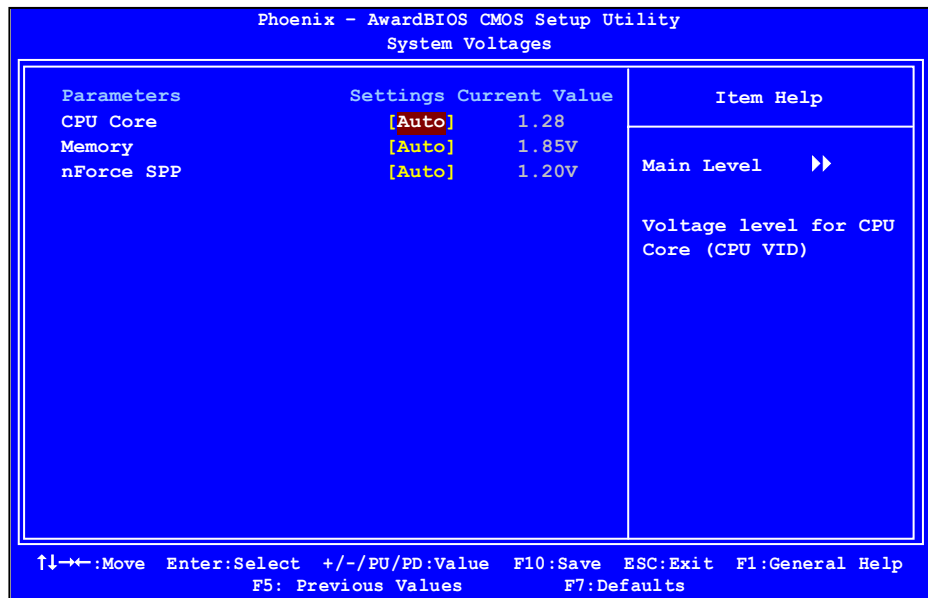

Figure 12. System Voltages Menu

□ CPU Core

Use the **Page Up** and **Page Down** keys to scroll through the voltages or select **[Auto]** to automatically set the voltage level for the CPU Core.

□ Memory

This function defines the voltage level for the DRAM. Use the **Page Up** and **Page Down** keys to select a voltage or select **[Auto]** to automatically set the voltage.

□ nForce SPP

This function defines the core voltage level for the NVIDIA nForce SPP chip. Use the **Page Up** and **Page Down** keys to select a voltage (1.20V, 1.30V, 1.40V, 1.50V) or select **[Auto]** to automatically set the voltage.

NVMEM Memory Test

This function defines whether you run the NVIDIA memory testing module during POST. The options are Fast, Medium, Slow, and Disable.

Load Timing/Voltage Set

This function loads the system voltages and timing settings that were defined in the System Voltages menu. You can set up to four profile settings using the **Save timing/voltage set** function.

There are four profile options that can be loaded. The default setting is **Auto** for all settings. Press **Enter** to see the options.

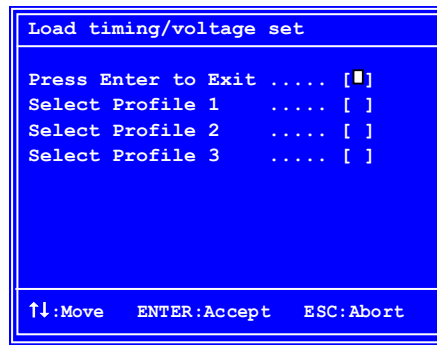

```
Load timing/voltage set

Press Enter to Exit ..... [ ]
Select Profile 1 ..... [ ]
Select Profile 2 ..... [ ]
Select Profile 3 ..... [ ]

↑↓:Move  ENTER:Accept  ESC:Abort
```

Save Timing/Voltage Set

This function saves the system voltages and timing settings that were defined in the System Voltages menu. There are four profile options that can be loaded. The default setting is **Auto** for all settings. Press **Enter** to see the options.

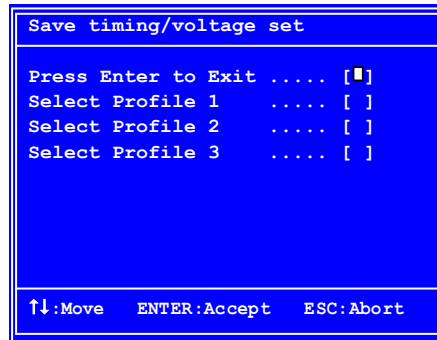

System BIOS Cacheable

This function allows you to enable or disable caching the system BIOS.

HPET Function

This function allows you to enable or disable the High Precision Even Timer (HPET). When **Enabled**, HPET is used as the timing hardware for multimedia and other time-sensitive application. When HPET is **Disabled**, the APIC timer is used.

NVIDIA GPU Ex

To enable or disable this function you need to have the NVIDIA® ForceWare® graphics driver with NVIDIA EX support. When enabled, the system uses the optimized NVIDIA EX graphics driver.

Integrated Peripherals Menu

Select **Integrated Peripherals** from the CMOS Setup Utility menu and press **Enter** to display the Integrated Peripherals menu.

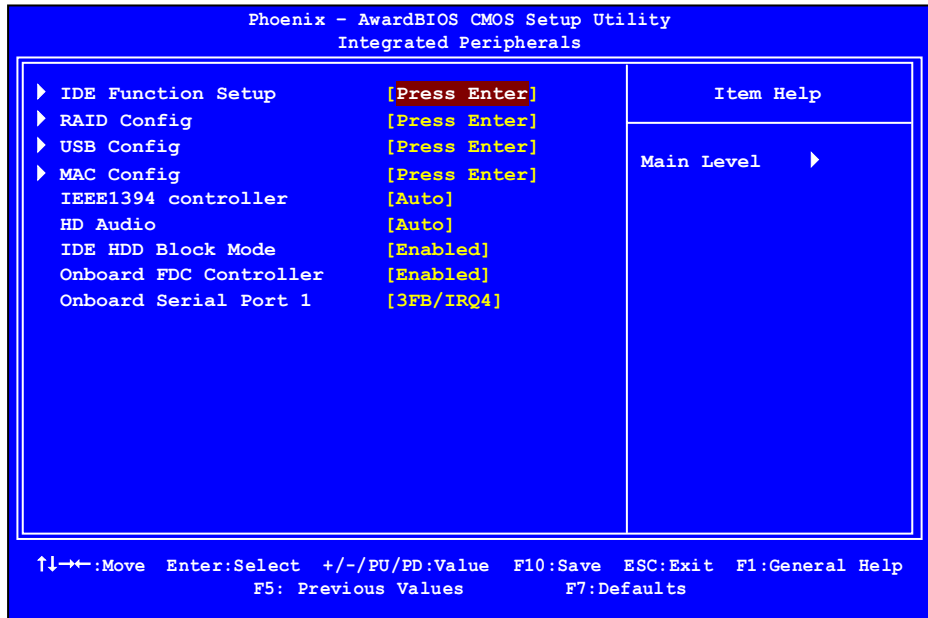

Figure 13. Integrated Peripherals Menu

IDE Function Setup

Press **Enter** to display the IDE Function Setup menu.

OnChip IDE Channel0	[Enabled]
Primary Master PIO	[Auto]
Primary Slave PIO	[Auto]
Primary Master UDMA	[Auto]
Primary Slave UDMA	[Auto]
IDE DMA transfer access	[Enabled]
Serial-ATA Controller	[All Enabled]
IDE Prefetch Mode	[Enabled]

❑ OnChip IDE Channel0

Use this function to enable or disable the onchip IDE Channel0. When disabled, the Primary Master/Slave functions are changed to **Auto** and cannot be changed.

OnChip IDE Channel0	[Disabled]
x Primary Master PIO	Auto
x Primary Slave PIO	Auto
x Primary Master UDMA	Auto
x Primary Slave UDMA	Auto
IDE DMA transfer access	[Enabled]
Serial-ATA Controller	[All Enabled]
IDE Prefetch Mode	[Enabled]

❑ Primary Master/Slave PIO

When **OnChip IDE Channel0** is set to **[Enabled]**, you can select a mode for the primary Master and Slave PIO. Select from **Auto**, or **Mode 1** through **Mode 4**.

❑ Primary Master/Slave UDMA

When **OnChip IDE Channel0** is set to **[Enabled]**, you can disable the primary Master and Slave UDMA or set it to **[Auto]**.

❑ IDE DMA transfer access

Use this function to enable or disable IDE DMA transfer access.

❑ Serial-ATA Controller

This function allows you to enable specific SATA controllers, enable all controllers, or disable all controllers. The options available are **[SATA-0]**, **[SATA-0+1]**, **[Enable All]**, and **[Disabled]**.

❑ IDE Prefetch Mode

Use this function to enable or disable the IDE Prefetch mode.

RAID Config

Press **Enter** to display the RAID Config menu.

RAID Enable		[Enabled]
SATA 0 Primary	RAID	[Disabled]
SATA 0 Secondary	RAID	[Disabled]
SATA 1 Primary	RAID	[Disabled]
SATA 1 Secondary	RAID	[Disabled]
SATA 2 Primary	RAID	[Disabled]
SATA 2 Secondary	RAID	[Disabled]

❑ RAID Enable

Use this function to enable or disable RAID. When RAID is set to [Disabled], all SATA functions are changed to Disabled and cannot be changed.

RAID Enable		[Disabled]
x SATA 0 Primary	RAID	Disabled
x SATA 0 Secondary	RAID	Disabled
x SATA 1 Primary	RAID	Disabled
x SATA 1 Secondary	RAID	Disabled
x SATA 2 Primary	RAID	Disabled
x SATA 2 Secondary	RAID	Disabled

❑ SATA x Primary/Secondary

When **RAID Enable** is set to [Enabled], you can enable or disable the various SATA functions.

USB Config

Press **Enter** to display the USB Config menu.

OnChip USB		[Enabled]
USB Keyboard Support		[Disabled]
USB Mouse Support		[Disabled]

❑ OnChip USB

Use this function to enable specific versions of the USB or disable the onchip USB.

When the onchip USB is set to [Disabled], the keyboard and mouse support functions are set to **Enabled** and cannot be changed. Versions that can be selected are [V1.1+V2.0] or [V1.1].

OnChip USB		[Disabled]
x USB Keyboard Support		Enabled
x USB Mouse Support		Enabled

❑ USB Keyboard/Mouse Support

Use these function to enable or disable the onchip WSB support of the keyboard and/or mouse.

MAC Config

Press **Enter** to display the MAC Config menu.

MAC0 LAN	[Enabled]
MAC1 LAN	[Disabled]

□ MACx LAN

Use these functions to set the MAC0 and/or MAC1 LANs to **Auto** or disable their functions.

HD Audio

This function on the Integrated Peripherals menu allows you to enable or disable the hard disk audio function.

IDE HDD Block Mode

Using this function on the Integrated Peripherals menu allows your IDE hard drive needs to support block mode. Select **[Enabled]** to automatically detect the optimal number of block read/writes per sector the drive can support. Select **[Disabled]** if your drive does not support block mode.

Onboard FDC Controller

This function on the Integrated Peripherals menu allows you to enable or disable the onboard FDC controller function.

Onboard Serial Port 1

This function on the Integrated Peripherals menu allows you to select the onboard serial port 1 function. Options are **[3F8/IRQ4]**, **[2E8/IRQ3]**, **[3E8/IRQ4]**, **[Auto]**, and **[Disabled]**.

Power Management Setup Menu

Select **Power Management Setup** from the CMOS Setup Utility menu and press **Enter** to display the Power Management Setup menu.

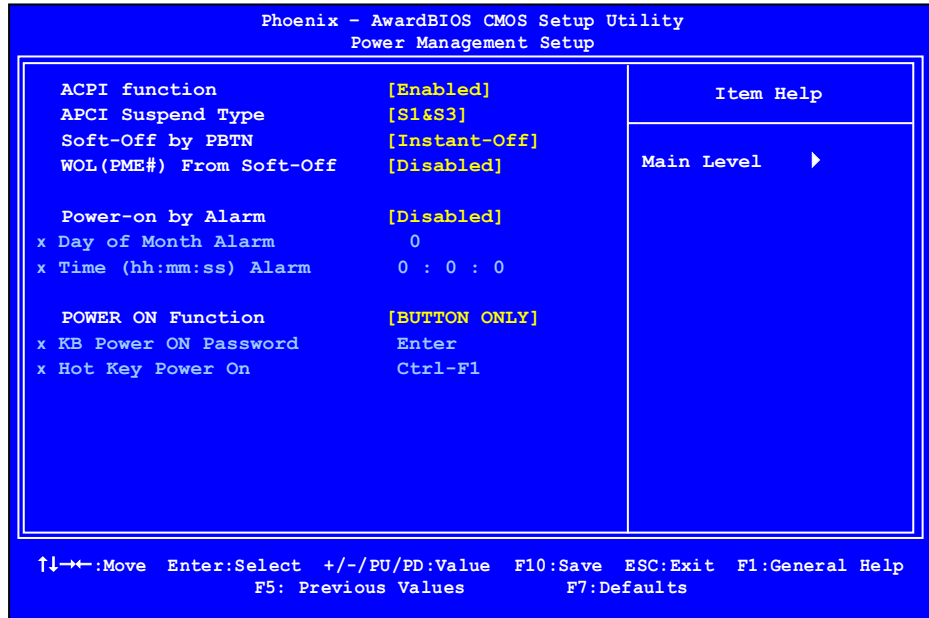

Figure 14. Power Management Setup Menu

ACPI Function

This function on the Power Management Setup menu allows you to enable or disable the ACPI function.

ACPI Suspend Type

This function on the Power Management Setup menu allows you to select an ACPI Suspend Type. Types to select from are **[S1&S3]**, **[S1 (POS)]**, and **[S3 (STR)]**.

Soft-Off by PBNT

This function on the Power Management Setup menu allows you to set Soft-Off by PBNT to **[Instant-Off]** or **[Delay 4 Sec]**.

WOL(PME#) From Soft-Off

This function on the Power Management Setup menu allows you to enable or disable WOL(PME#) from soft-off.

Power On by Alarm

This function on the Power Management Setup menu allows you to enable or disable the Power-on by alarm function. Set to **[Disable]** to prevent power-on by alarm. When set to **[Enable]**, you can manually put in the day of the month and the time of the alarm.

```
Power-on by Alarm      [Disabled]
Day of Month Alarm    [ 0]
Time (hh:mm:ss) Alarm [0 : 0 : 0]
```

To enter a day or time, use the **Page Up** and **Page Down** keys to scroll through numbers or enter the number using the keyboard number or the **+** and **-** keys.

POWER ON Function

This function on the Power Management Setup menu allows you to define the power-on function. Options for this function are:

- BUTTON ONLY
- Keyboard 98
- Password**

When **[Password]** is selected, the **KB Power ON Password** function is enabled so that you must enter a password.

```
POWER ON Function      [Password]
KB Power ON Password   [Enter]
x Hot Key Power On     Ctrl-F1
```

❑ **Hot Key Power On**

When **[Hot Key]** is selected, the **Hot key Power On** function is enabled so that you must select a keyboard key as the hot key. To select a hot key use **Ctrl+F1** though **Ctrl+F12**.

POWER ON Function	[Hot key]
x KB Power ON Password	Enter
Hot Key Power On	[Ctrl-F1]

- ❑ **Mouse Left**
- ❑ **Mouse Right**
- ❑ **Any Key**

PnP/PCI Configuration Menu

Select **PnP/PCI Configuration** from the CMOS Setup Utility menu and press **Enter** to display the PnP/PCI Configuration menu.

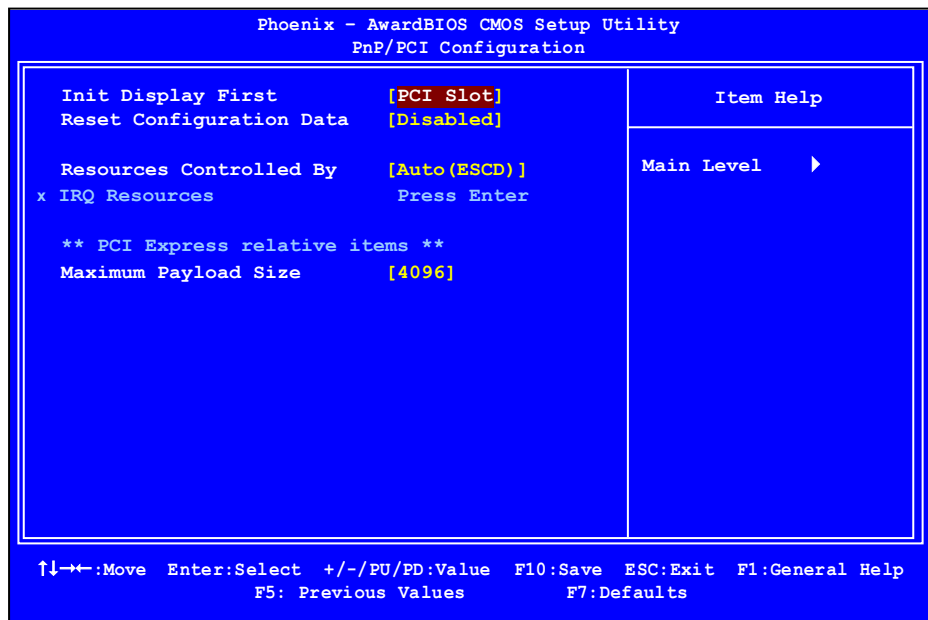

Figure 15. PnP/PCI Configuration Menu

Init Display First

This function on the PnP/PCI Configuration menu allows you to define if the initial display is in the PCI slot or in the PCI Express slot. Options are **[PCI Slot]** and **[PCIEx]**.

Reset Configuration Data

This function on the PnP/PCI Configuration menu allows you to enable or disable the resetting of Extended System Configuration Data (ESCD) when you exit Setup. Set this to **[Enabled]** if you have installed a new add-on and the system reconfiguration has caused a serious conflict that prevents the OS from booting. The default setting is **[Disabled]**.

Resources Controlled By

This function on the PnP/PCI Configuration menu allows you to define if the BIOS can automatically configure all the boot and plug-and-play compatible devices or if you can manually select IRQ, DMA, and memory base address fields. Select **[Auto (ESCD)]** if you want the BIOS to automatically populate these fields. If you select **[Manual]** so you can assign the resources, **IRQ Resources** is enabled for input.

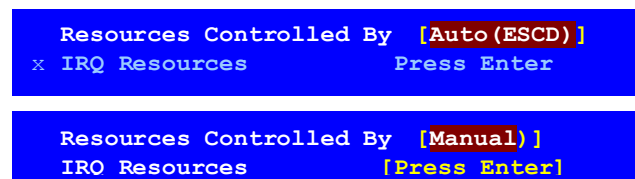

IRQ Resources

To enable this field for input, set **Resources Controlled By** to **[Manual]**. With this field enabled, press **Enter** to see options.

IRQ-5	assigned to	[PCI Device]
IRQ-9	assigned to	[Reserved]
IRQ-10	assigned to	[PCI Device]
IRQ-11	assigned to	[PCI Device]
IRQ-14	assigned to	[PCI Device]
IRQ-15	assigned to	[PCI Device]

Use Legacy ISA for devices compliant with the original PC AT Bus specification. Use PCI/ISA PnP for devices compliant with the plug-and-play standard, whether designed for PCI or ISA Bus architecture.

PCI/VGA Palette Snoop

This function on the PnP/PCI Configuration menu allows you to enable or disable the Palette Snoop function.

Maximum Payload Size

This function on the PnP/PCI Configuration menu allows you to set the maximum TLP payload size (in bytes) for the PCI Express devices. Use the **Page Up** and **Page Down** keys to scroll through sizes or enter the number using the keyboard numbers or use the **+** and **-** keys to go up and down the list of sizes.

System Monitor Menu

Select **System Monitor** from the CMOS Setup Utility menu and press **Enter** to display the System Monitor menu.

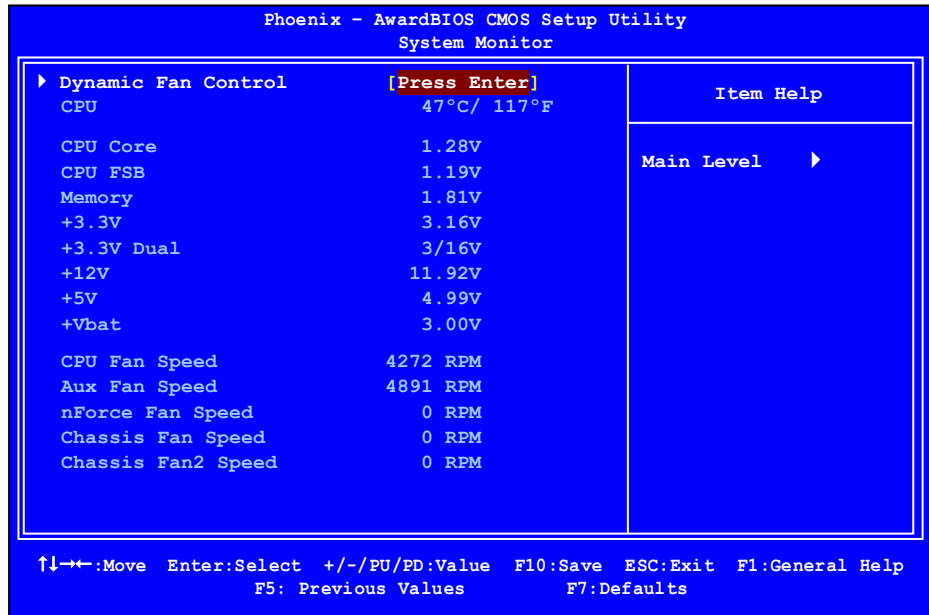

Figure 16. System Monitor Menu

All of the values shown in **Blue** are dynamic and change as the speed and voltages of the various components change with system usage.

Dynamic Fan Control

Press **Enter** to display the Dynamic Fan Control menu.

```
CPU Fan Speed Control      [SmartFan]
If temp > 70°C, Set Fan Speed 100%
If temp < 30°C, Set Fan Speed  0%
x Manual Fan Speed, %      100

AUX Fan Speed Control, %  [100]
nForce Fan Speed Control, % [100]
Chassis Fan Speed Control, % [100]
```

Use this menu to control the speed of the various fans on the motherboard. Set CPU fan speed to **[SmartFan]** when you want the speed of the fans automatically controlled based on temperature. To set the fan speed to a constant rate, select **[Manual]** and then enter the speed from 0% to 100%.

Set the desired speed for the Aux, nForce, and Chassis fans from 0% to 100%. The system defaults to 100%.

This page is blank.

Index

ACPI function.....	54	Standard CMOS Features	28
ACPI Suspend Type.....	54	System Clocks.....	38
Advanced BIOS Features	33	System Monitor menu.....	59
Advanced Chipset Functions menu ..	37	System Voltages.....	46
Advanced Programmable Interrupt Controller.....	36	BIOS, configuring.....	24
APIC.....	36	block mode, IDE HDD	53
ATX form factor	5	boot device priority	35
auto-detect IDE and SATA channels	30	C1E Enhanced Halt State	46
Base Memory	32	Chassis Backpanel Connectors	9
BIOS CMOS Setup Utility Main Menu	26	CHS	30
BIOS menus		CMOS RAM jumper.....	23
Advanced BIOS Features menu ...	33	Command Per Clock	44
Advanced Chipset Features	37	configure IDE and SATA channels, BIOS	29
CMOS Setup Utility menu.....	26	configuring the BIOS.....	24
CPU Configuration	45	connectors	
FSB & Memory Config	41	COM1	21
Integrated Peripherals	50	CPU fan	21
Main Menu	25	FDD.....	21
Memory Timing Setting.....	42	IDE.....	16
PnP/PCI Configuration	56	PWR1	15
Power Management Setup	54	PWR2	16

SATA	16	FSB and Memory Clock Mode	41
Cooling fan for CPU	viii	FSB Reference Clock	39
CPU Configuration menu.....	45	FSB speeds.....	1
CPU cooling fan	viii	full-screen logo.....	36
CPU Core 1	46	Gigabit Ethernet.....	3
CPU fan	12, 21	Halt On sub-menu	31
CPU Freq	39	hard disk audio function	53
CPU internal cache.....	34	Hard Disk Boot Priority	34
CPU Multiplier	39	hard disk drive indicator LED	18
CPU Spread Spectrum	40	HD_LED	18
CPU Thermal Control	45	high definition audio.....	4
CPU, installing.....	11	High Precision Even Timer.....	49
date and time, setting in BIOS	29	hot key power on.....	56
DDR2 memory	12	How to	
dual channel DDR2	12	configure CPU in BIOS	45
Dynamic Fan Control menu.....	60	configure RAID in BIOS	52
ESCD.....	57	configure USB in BIOS	52
Execute Disable Bit	46	connect IDE drives	16
expansion slots.....	22	connect power to motherboard ...	15
Extended Memory	32	install CPU	11
FDC controller function.....	53	install DIMMs	12
features, motherboard.....	1	set CMOS jumper	23
FirstPacket technology.....	3	set date and time	29
Frequency Settings.....	39	set disk priority	34
front panel header	18	set fan speeds in BIOS.....	59
Front Panel Header Pins	19	set fan speeds with BIOS.....	60
front panel power LED.....	18	set IDE functions in BIOS.....	51
FSB & Memory Config menu	41	set network boot priority.....	34
FSB (QDR)	42	set power management functions in BIOS.....	54

set system voltages in BIOS.....	46	memory support	viii
HPET.....	49	Memory Timing Setting	42
HT Multiplier.....	40	microprocessor	viii
HT Spread Spectrum	40	motherboard	
I/O shield	13	install procedure.....	13
IDE connector.....	16	motherboard specifications.....	5
IDE DMA transfer access	51	MPS	36
IDE Function Setup menu.....	51	Multi-Processor Specification.....	36
IDE Prefetch Mode	51	Network Boot Priority	34
IDE/SATA sub-menu	29	NumLock status	35
installing		NVIDIA EX support.....	49
CPU.....	11	NVIDIA memory testing module.....	48
I/O shield.....	13	TF650i Ultra-A7 Motherboard Layout.8	
memory DIMMs.....	12	onboard serial port 1 function.....	53
motherboard.....	13	OnChip IDE Channel0	51
Integrated Peripherals menu.....	50	OnChip USB	52
Intel microprocessor.....	viii	overclocking tools	1
internal headers.....	18	Palette Snoop function	58
PWRHD_LED.....	18	paring the motherboard.....	11
PWRLED	18	PCI Express x1 slot	23
PWRSW	18	PCI Express x16 slots	23
IRQ Resources	58	PCI slots.....	22
LBA	30	PCIe Spread Spectrum	40
Legacy ISA	58	PCIe x16	39
Limit CPUID MaxVal	45	PnP/PCI Configuration menu.....	56
load plate	11	power button cable	18
MAC Config menu	53	Power Management Setup menu.....	54
MediaShield	2	Power-on by alarm function.....	55
MEM (DDR)	42	power-on function.....	55

Primary Master/Slave PIO	51	Standard CMOS Features menu.....	28
Primary Master/Slave UDMA	51	System Clocks menu	38
PWR1 connector	15	system fan.....	21
PWR1 pin assignments.....	15	System Monitor menu	59
PWR2 connector	16	system voltages and timing settings	49
PWRLED	18	System Voltages menu	46
PWRSW	18	tCL.....	44
Quick Power On Self Test	35	TLP payload size.....	58
RAID Config menu	52	Total Memory	32
Ref Clock, SPP↔MCP	39	tRAS.....	44
removable device startup priority....	34	tRC.....	44
RESET	18	tRDC.....	44
Reset switch cable	18	tREF.....	44
safety instructions.....	10	tRP.....	44
SATA Spread Spectrum	40	tRRD.....	44
Security Options.....	36	tWR.....	44
Serial ATA II connector	16	tWTR.....	44
Serial-ATA Controller	51	USB 2.0 ports	20
How to	38	USB Config menu.....	52
Soft-Off by PBNT	55	USB Keyboard/Mouse Support ..	52
Spread Spectrum	40	Virtualization Technology	46