

FCC Information and Copyright

This equipment has been tested and found to comply with the limits of a Class B digital device, pursuant to Part 15 of the FCC Rules. These limits are designed to provide reasonable protection against harmful interference in a residential installation. This equipment generates, uses, and can radiate radio frequency energy and, if not installed and used in accordance with the instructions, may cause harmful interference to radio communications. There is no guarantee that interference will not occur in a particular installation.

The vendor makes no representations or warranties with respect to the contents here and specially disclaims any implied warranties of merchantability or fitness for any purpose. Further the vendor reserves the right to revise this publication and to make changes to the contents here without obligation to notify any party beforehand.

Duplication of this publication, in part or in whole, is not allowed without first obtaining the vendor's approval in writing.

The content of this user's manual is subject to be changed without notice and we will not be responsible for any mistakes found in this user's manual. All the brand and product names are trademarks of their respective companies.

Table of Contents

Chapter 1: Introduction	1
1.1 Before You Start	1
1.2 Package Checklist	1
1.3 Motherboard Features	2
1.4 Rear Panel Connectors	4
1.5 Motherboard Layout	5
Chapter 2: Hardware Installation	6
2.1 Installing Central Processing Unit (CPU)	6
2.2 FAN Headers	8
2.3 Installing System Memory	9
2.4 Connectors and Slots	11
Chapter 3: Headers & Jumpers Setup	16
3.1 How to Setup Jumpers	16
3.2 Detail Settings	16
Chapter 4: (Hybrid) CrossFireX Function	21
4.1 CrossFireX Requirements	21
4.2 CrossFireX Installation	21
4.3 Hybrid CrossFireX Requirements	22
4.4 Hybrid CrossFireX Installation	22
4.5 Operation Modes Supporting List	23
Chapter 5: RAID Functions	24
5.1 Operating System	24
5.2 Raid Arrays	24
5.3 How RAID Works	24
Chapter 6: T-Series BIOS & Software	28
6.1 T-Series BIOS	28
6.2 T-Series Software	36
Chapter 7: Useful Help	46
7.1 Driver Installation Note	46
7.2 Extra Information	47
7.3 AMI BIOS Beep Code	48
7.4 Troubleshooting	49
Appendix: SPEC In Other Languages	50
German	50
French	52
Italian	54
Spanish	56
Portuguese	58
Polish	60
Russian	62
Arabic	64
Japanese	66

CHAPTER 1: INTRODUCTION

1.1 BEFORE YOU START

Thank you for choosing our product. Before you start installing the motherboard, please make sure you follow the instructions below:

- Prepare a dry and stable working environment with sufficient lighting.
- Always disconnect the computer from power outlet before operation.
- Before you take the motherboard out from anti-static bag, ground yourself properly by touching any safely grounded appliance, or use grounded wrist strap to remove the static charge.
- Avoid touching the components on motherboard or the rear side of the board unless necessary. Hold the board on the edge, do not try to bend or flex the board.
- Do not leave any unfastened small parts inside the case after installation. Loose parts will cause short circuits which may damage the equipment.
- Keep the computer from dangerous area, such as heat source, humid air and water.

1.2 PACKAGE CHECKLIST

- ✚ IDE Cable X 1
- ✚ Serial ATA Cable X 2
- ✚ Serial ATA Power Cable X 1
- ✚ Rear I/O Panel for ATX Case X 1
- ✚ User's Manual X 1
- ✚ Fully Setup Driver CD X 1
- ✚ DCCFX-P2 Paddle Card X 1
- ✚ FDD Cable X 1 (optional)
- ✚ USB 2.0 Cable X1 (optional)
- ✚ S/PDIF out Cable X 1 (optional)

Note: The package contents may be different due to area or your motherboard version.

1.3 MOTHERBOARD FEATURES

SPEC		
CPU	Socket AM2+ / AM3 AMD Athlon 64 / Athlon 64 FX / Athlon 64 x2 / Sempron / Phenom / Phenom II processors	AMD 64 Architecture enables 32 and 64 bit computing Supports Hyper Transport 3.0 and PowerNow
FSB	Support HyperTransport 3.0 Supports up to 5.2 GT/s Bandwidth	
Chipset	AMD 790GX AMD SB750	
Super I/O	ITE 8718 Provides the most commonly used legacy Super I/O functionality. Low Pin Count Interface	Environment Control initiatives, H/W Monitor Fan Speed Controller ITE's "Smart Guardian" function
Main Memory	DDR2 DIMM Slots x 4 Max Memory Capacity 16GB Each DIMM supports 256MB/512MB/ 1GB/2GB/4GB DDR2	Dual Channel Mode DDR2 memory module Supports DDR2 533 / 667 / 800 Supports DDR2 1066 (by AM2+ / AM3 CPU) Registered DIMM and ECC DIMM is not supported
Graphics	Radeon HD 3300	Onboard side port memory 128MB DDR2 Max Shared Video Memory is 512MB DX10/UVD/HDCP support (Hybrid) CrossFireX support (by ATI driver)
IDE	AMD SB750	Ultra DMA 33 / 66 / 100 / 133 Bus Master Mode supports PIO Mode 0~4,
SATA II	AMD SB750	Data transfer rates up to 3 Gb/s. SATA Version 2.0 specification compliant. RAID 0,1,5,1+0 support
LAN	Realtek RTL 8111DL	10 / 100 Mb/s / 1Gb/s auto negotiation Half / Full duplex capability
Sound	ALC888	7.1channels audio out Supports HD Audio

SPEC			
Slots	PCI Slot	x2	Supports PCI expansion cards
	PCI Express Gen2 x16 Slot	x2	Supports PCI-E Gen2 x16 expansion cards
	PCI Express Gen2 x1 Slot	x2	Supports PCI-E Gen2 x1 expansion cards
On Board Connectors	Floppy Connector	x1	Each connector supports 2 Floppy drives
	IDE Connector	x1	Each connector supports 2 IDE device
	SATA Connector	x6	Each connector supports 1 SATA devices
	Front Panel Connector	x1	Supports front panel facilities
	Front Audio Connector	x1	Supports front panel audio function
	CD-in Connector	x1	Supports CD audio-in function
	S/PDIF out Connector	x1	Supports digital audio out function
	CPU Fan Header	x1	CPU Fan power supply (with Smart Fan function)
	System Fan Header	x2	System Fan Power supply
	CMOS clear Header	x1	Restore CMOS data to factory default
	USB Connector	x3	Each connector supports 2 front panel USB ports
	Power Connector (24pin)	x1	Connects to Power supply
Power Connector (4pin)	x2	Connects to Power supply	
Back Panel I/O	PS/2 Keyboard	x1	Connects to PS/2 Keyboard
	PS/2 Mouse	x1	Connects to PS/2 Mouse
	HDMI port	x1	Connect to HDTV
	VGA port	x1	Connect to D-SUB monitor
	DVI-D port	x1	Connect to DVI monitor
	LAN port	x1	Connect to RJ-45 ethernet cable
	USB Port	x4	Connect to USB devices
Audio Jack	x6	Provide Audio-In/Out and microphone connection	
Board Size	225 mm (W) x 305 mm (L)		ATX
OS Support	Windows XP / Vista 32 / Vista 64		Biostar reserves the right to add or remove support for any OS With or without notice.

1.4 REAR PANEL CONNECTORS

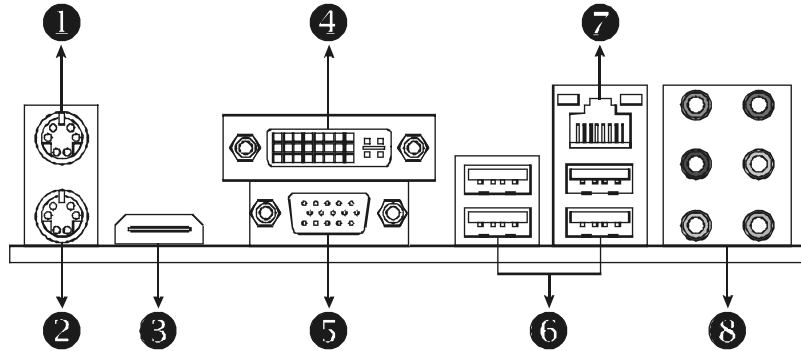

1 PS/2 Mouse Port

2 PS/2 Keyboard Port

3 HDMI Port

The High-Definition Multimedia Interface (HDMI) is an all-digital audio/video interface capable of transmitting uncompressed streams to an AV receiver or any compatible digital audio and/or video monitor, such as a digital television.

4 DVI-D VGA Port

The Digital Visual Interface (DVI) is a video interface transmitting digital video signals to digital display devices such as flat panel LCDs or digital projectors. The DVI-D connector allows digital signals transmission only.

5 D-Sub VGA Port

Transmit analog video signals to computer monitor or any other display panels equipped with D-Sub VGA input.

6 USB 2.0 Port x 4

7 10/100/1000 Mbps LAN Port

8 Audio Jack x 6

Port	2-Channel	4-Channel	6-Channel/8-Channel
Blue	Line-In	Line-In	Line-In
Green	Line-Out	Front Speaker Out	Front Speaker Out
Pink	Mic In	Mic In	Mic In
Orange			Center/Subwoofer
Black	Rear Speaker Out	Rear Speaker Out	Rear Speaker Out
Grey			Side Speaker Out

NOTE: The HDMI and DVI-D ports both can provide digital video signals out-put function, but these two interfaces cannot work at the same time. The chipset uses the same channel to control HDMI and DVI-D, so these ports cannot transmit video signal to different display panels simultaneously.

1.5 MOTHERBOARD LAYOUT

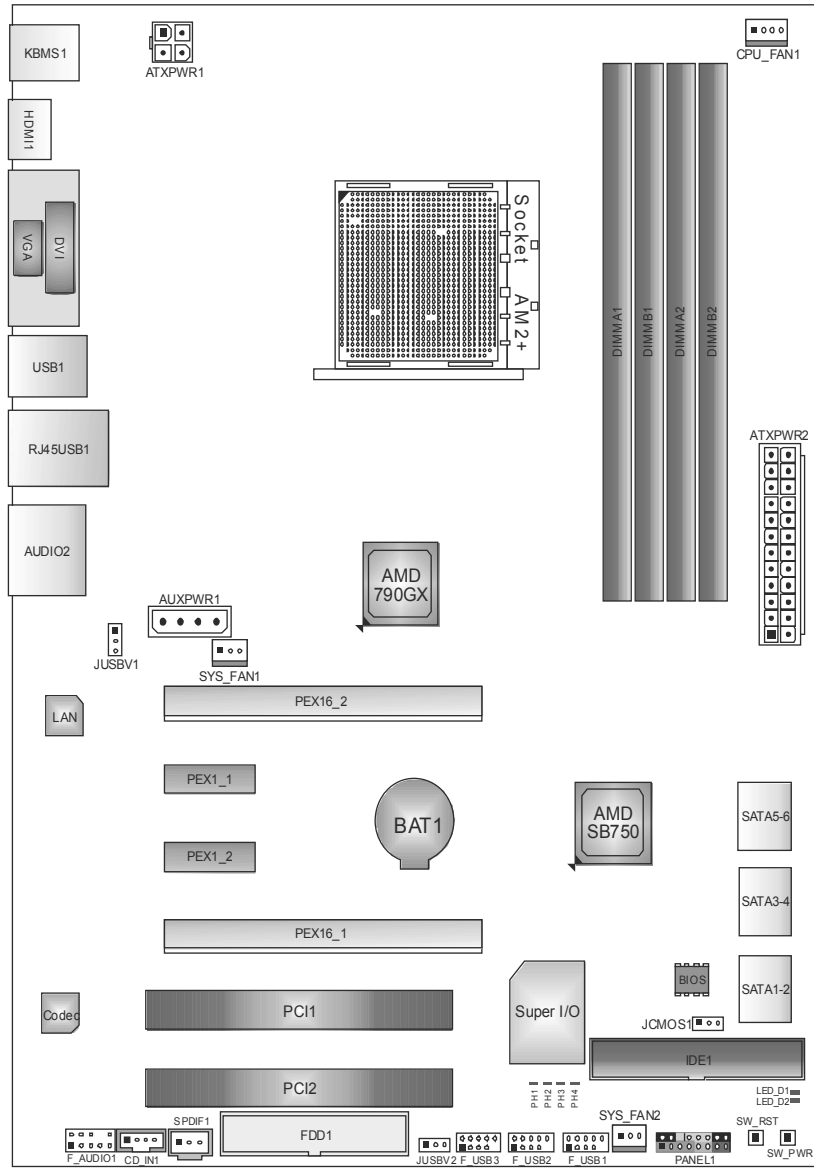

Note: ■ represents the 1st pin.

CHAPTER 2: HARDWARE INSTALLATION

2.1 INSTALLING CENTRAL PROCESSING UNIT (CPU)

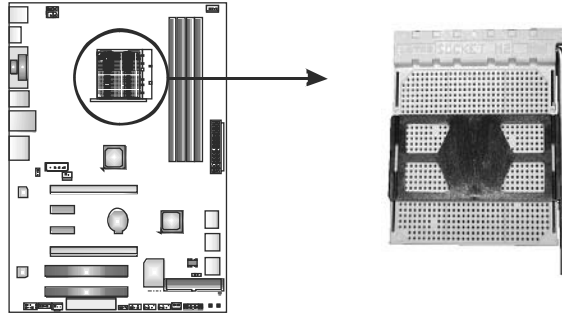

Step 1: Remove the socket protection cap.

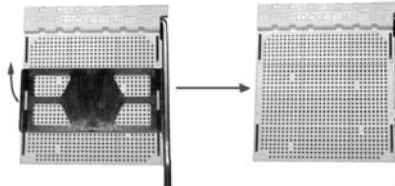

Step 2: Pull the lever toward direction A from the socket and then raise the lever up to a 90-degree angle.

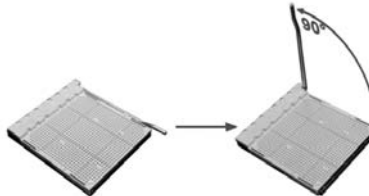

Step 3: Look for the white triangle on socket, and the gold triangle on CPU should point towards this white triangle. The CPU will fit only in the correct orientation.



Step 3: Hold the CPU down firmly, and then close the lever toward direct B to complete the installation.

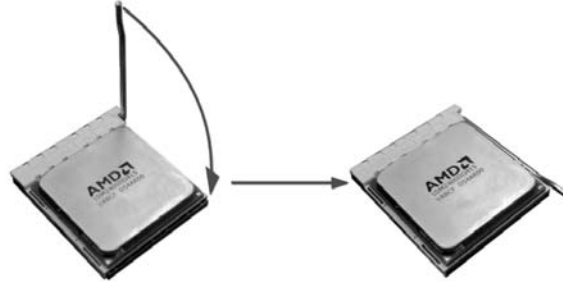

Step 4: Put the CPU Fan on the CPU and buckle it. Connect the CPU FAN power cable to the JCFAN1. This completes the installation.

2.2 FAN HEADERS

These fan headers support cooling-fans built in the computer. The fan cable and connector may be different according to the fan manufacturer. Connect the fan cable to the connector while matching the black wire to pin#1.

CPU_FAN1: CPU Fan Header

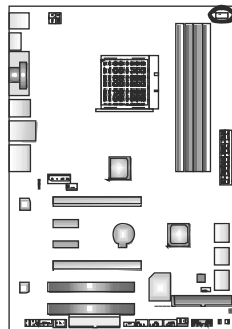

Pin	Assignment
1	Ground
2	+12V
3	FAN RPM rate sense
4	Smart Fan Control (By Fan)

SYS_FAN1/SYS_FAN2: System Fan Headers

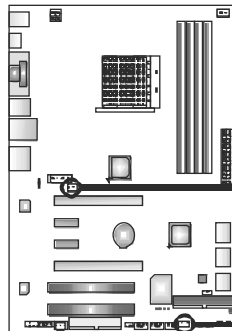

SYS_FAN1



SYS_FAN2

Pin	Assignment
1	Ground
2	+12V
3	FAN RPM rate sense

Note:

The CPU_FAN1, SYS_FAN1, and SYS_FAN2 support 4-pin and 3-pin head connectors. When connecting with wires onto connectors, please note that the red wire is the positive and should be connected to pin#2, and the black wire is Ground and should be connected to GND.

2.3 INSTALLING SYSTEM MEMORY

A. DDR2 Modules

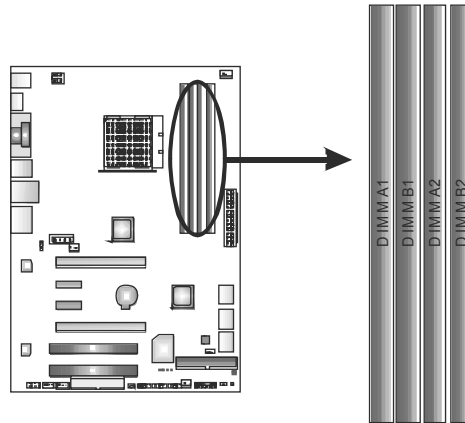

1. Unlock a DIMM slot by pressing the retaining clips outward. Align a DIMM on the slot such that the notch on the DIMM matches the break on the Slot.

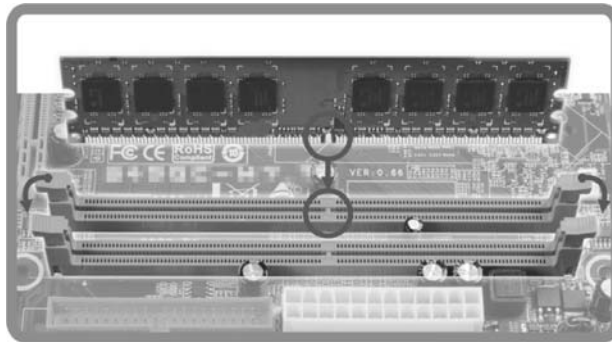

2. Insert the DIMM vertically and firmly into the slot until the retaining chip snap back in place and the DIMM is properly seated.

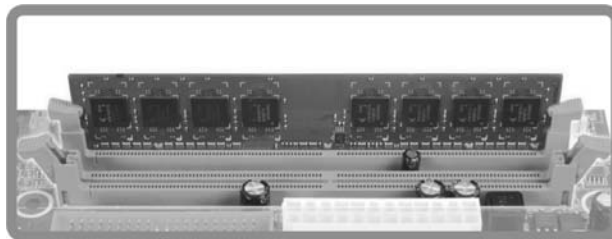

B. Memory Capacity

DIMM Socket Location	DDR2 Module	Total Memory Size
DIMMA1	256MB/512MB/1GB/2GB/4GB	Max is 16GB.
DIMMB1	256MB/512MB/1GB/2GB/4GB	
DIMMA2	256MB/512MB/1GB/2GB/4GB	
DIMMB2	256MB/512MB/1GB/2GB/4GB	

C. Dual Channel Memory installation

Please refer to the following requirements to activate Dual Channel function:

Install memory module of the same density in pairs, shown in the table.

Dual Channel Status	DIMMA1	DIMMB1	DIMMA2	DIMMB2
Enabled	O	O	X	X
Enabled	X	X	O	O
Enabled	O	O	O	O

(O means memory installed, X means memory not installed.)

The DRAM bus width of the memory module must be the same (x8 or x16)

2.4 CONNECTORS AND SLOTS

FDD1: Floppy Disk Connector

The motherboard provides a standard floppy disk connector that supports 360K, 720K, 1.2M, 1.44M and 2.88M floppy disk types. This connector supports the provided floppy drive ribbon cables.

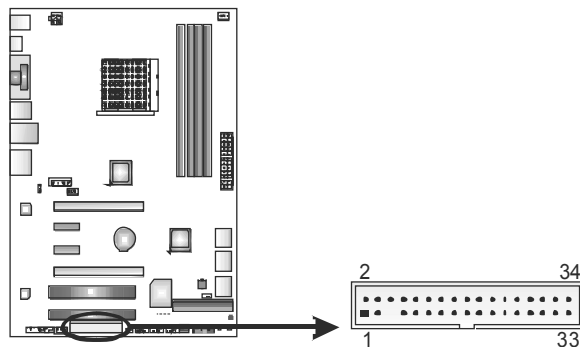

IDE1: IDE/ATAPI Connector

The motherboard has a 32-bit Enhanced IDE Controller that provides PIO Mode 0~4, Bus Master, and Ultra DMA 33/66/100/133 functionality.

The IDE connector can connect a master and a slave drive, so you can connect up to two drives.

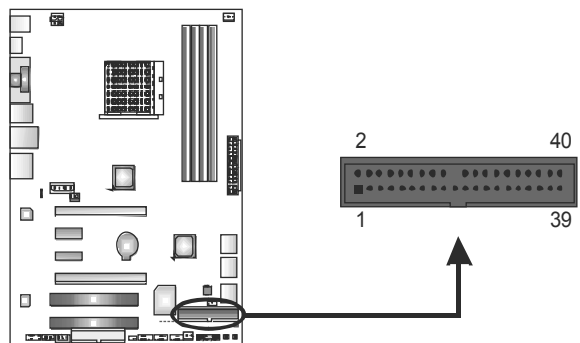

SATA1-2/SATA3-4/SATA5-6: Serial ATA Connectors

The motherboard has a PCI to SATA Controller with 6 channels SATA interface, it satisfies the SATA 2.0 spec and with transfer rate of 3.0Gb/s.

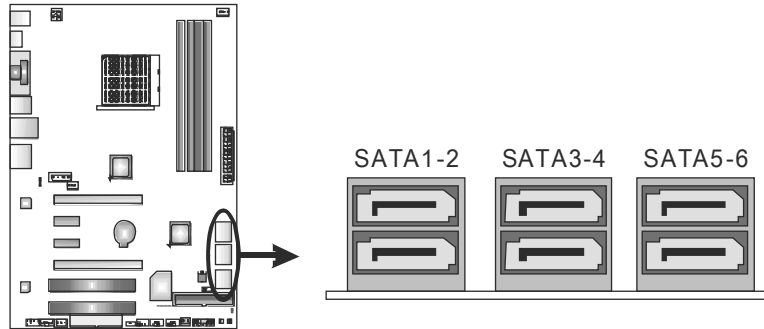

AUXPWR1: Auxiliary Power for Graphics

This connector is an auxiliary power connection for graphics cards. Exclusive power for the graphics card provides better graphics performance.

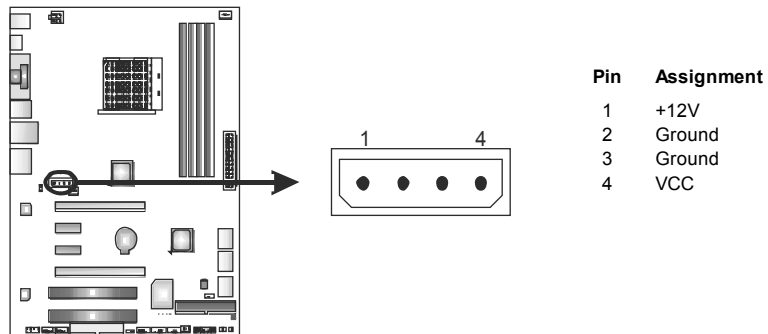

ATXPWR2: ATX Power Source Connector

This connector allows user to connect 24-pin power connector on the ATX power supply.

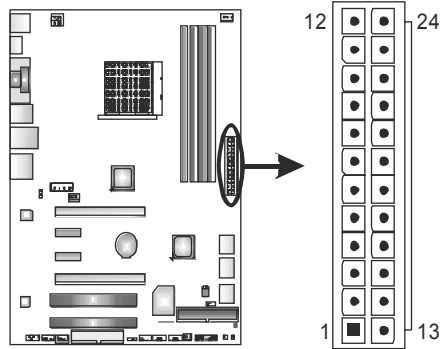

Pin	Assignment	Pin	Assignment
13	+3.3V	1	+3.3V
14	-12V	2	+3.3V
15	Ground	3	Ground
16	PS_ON	4	+5V
17	Ground	5	Ground
18	Ground	6	+5V
19	Ground	7	Ground
20	NC	8	PW_OK
21	+5V	9	Standby Voltage+5V
22	+5V	10	+12V
23	+5V	11	+12V
24	Ground	12	+3.3V

ATXPWR1: ATX Power Source Connector

Connecting this connector will provide +12V to CPU power circuit.

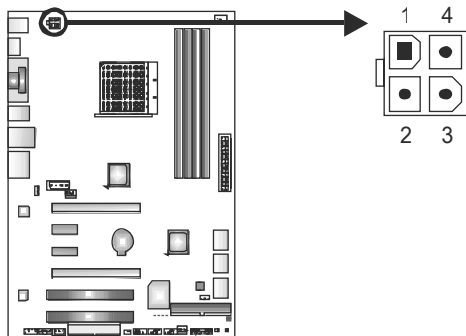

Pin	Assignment
1	+12V
2	+12V
3	Ground
4	Ground

Note:

Before power on the system, please make sure that both ATXPWR1 and ATXPWR2 connectors have been plugged-in.

PEX16_1: PCI-Express Gen2 x16 Slot (x16/x8 Speed)

- PCI-Express 2.0 compliant.
- PCI-Express Gen2 supports a raw bit-rate of 5.0Gb/s on the data pins.
- 2X bandwidth over the PCI-Express 1.1 architecture.
- x16 Speed Mode: Maximum theoretical realized bandwidth of 8GB/s simultaneously per direction, for an aggregate of 16GB/s totally. **(Must be with DCCFX-P2 in PEX16_2)**
- x8 Speed Mode: Maximum theoretical realized bandwidth of 4GB/s simultaneously per direction, for an aggregate of 8GB/s totally. **(Without DCCFX-P2 in PEX16_2 or using CrossFireX)**
- PEX16_1 slot is reserved for graphics or video cards. The design of this motherboard supports dual PCI-Express graphics cards using CrossFireX technology with multiple displays. When using CrossFireX, this slot is master and runs with x8 speed.
- **To make this slot run with x16 speed, please insert the Paddle Card DCCFX-P2 into PEX16_2.**

PEX16_2: PCI-Express Gen2 x16 Slot (x8 Speed)

- PCI-Express 2.0 compliant.
- PCI-Express Gen2 supports a raw bit-rate of 5.0Gb/s on the data pins.
- 2X bandwidth over the PCI-Express 1.1 architecture.
- x8 Speed Mode: Maximum theoretical realized bandwidth of 4GB/s simultaneously per direction, for an aggregate of 8GB/s totally.
- PEX16_2 slot is reserved for graphics or video cards. The design of this motherboard supports dual PCI-Express graphics cards using CrossFireX technology with multiple displays. This slot is slave when using CrossFireX.
- **Note: NVIDIA Dual Graphics is not supported**

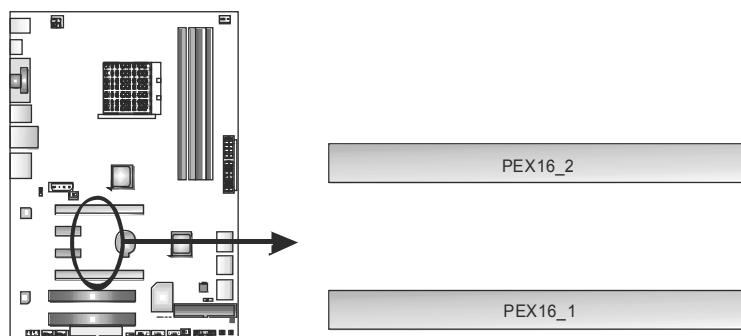

PEX1_1/PEX1_2: PCI-Express Gen2 x1 Slots

- PCI-Express 2.0 compliant.
- Data transfer bandwidth up to 500MB/s per direction; 1GB/s in total.
- PCI-Express Gen2 supports a raw bit-rate of 5.0Gb/s on the data pins.
- 2X bandwidth over the PCI-Express 1.1 architecture.

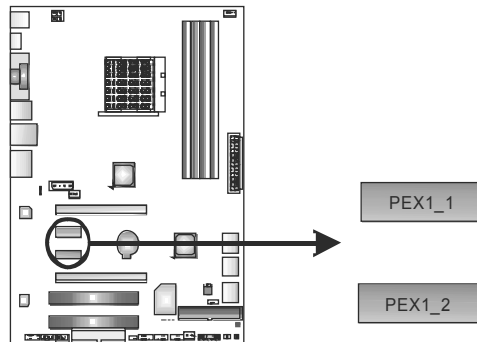
**PCI1~PCI2: Peripheral Component Interconnect Slots**

This motherboard is equipped with 2 standard PCI slots. PCI stands for Peripheral Component Interconnect, and it is a bus standard for expansion cards. This PCI slot is designated as 32 bits.

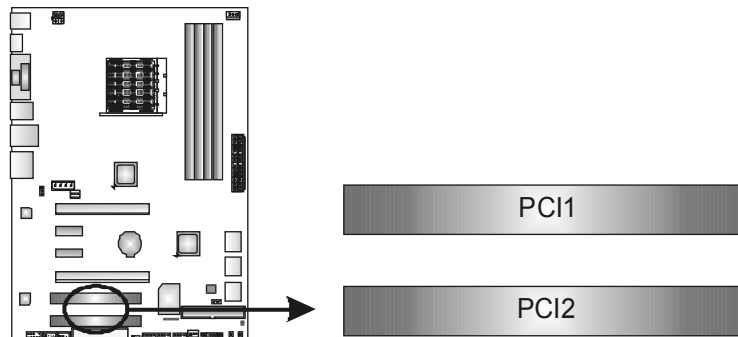

CHAPTER 3: HEADERS & JUMPERS SETUP

3.1 HOW TO SETUP JUMPERS

The illustration shows how to set up jumpers. When the jumper cap is placed on pins, the jumper is “close”, if not, that means the jumper is “open”.

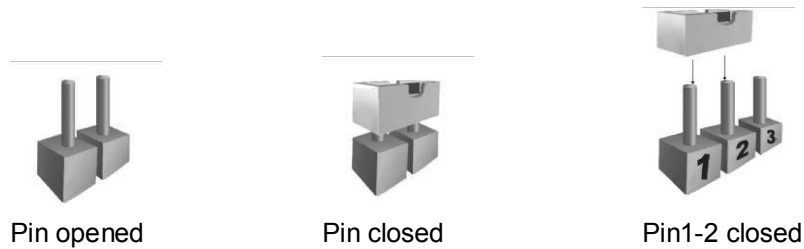

3.2 DETAIL SETTINGS

PANEL1: Front Panel Header

This 16-pin connector includes Power-on, Reset, HDD LED, Power LED, and speaker connection. It allows user to connect the PC case’s front panel switch functions.

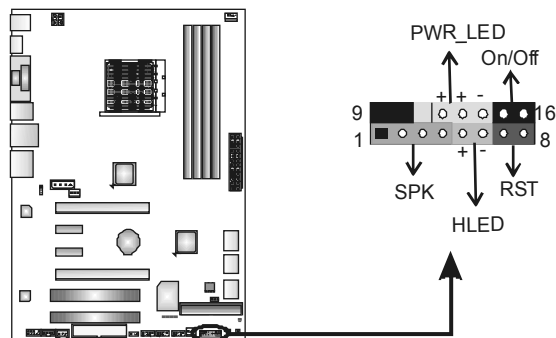

Pin	Assignment	Function	Pin	Assignment	Function
1	+5V		9	N/A	N/A
2	N/A	Speaker Connector	10	N/A	N/A
3	N/A		11	N/A	N/A
4	Speaker		12	Power LED (+)	Power LED
5	HDD LED (+)	13	Power LED (+)		
6	HDD LED (-)	14	Power LED (-)		
7	Ground	Reset button	15	Power button	Power-on button
8	Reset control		16	Ground	

JCMOS1: Clear CMOS Header

Placing the jumper on pin2-3 allows user to restore the BIOS safe setting and the CMOS data. Please carefully follow the procedures to avoid damaging the motherboard.

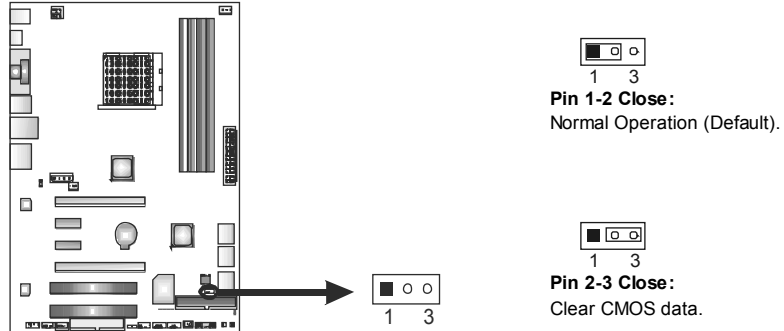

※ Clear CMOS Procedures:

1. Remove AC power line.
2. Set the jumper to "Pin 2-3 close".
3. Wait for five seconds.
4. Set the jumper to "Pin 1-2 close".
5. Power on the AC.
6. Reset your desired password or clear the CMOS data.

F_USB1~F_USB3: Headers for USB 2.0 Ports at Front Panel

This header allows user to connect additional USB cable on the PC front panel, and also can be connected with internal USB devices, like USB card reader.

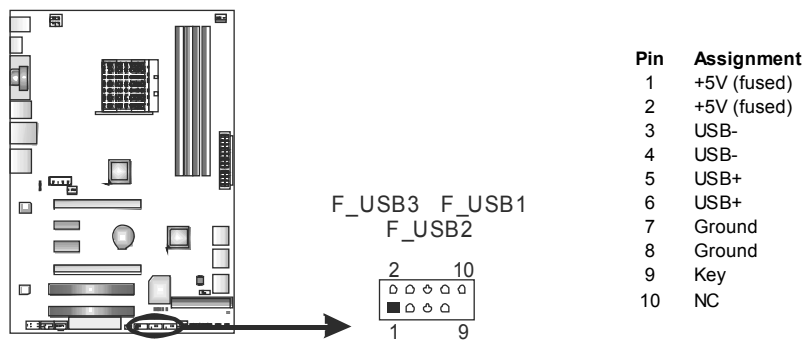

F_AUDIO1: Front Panel Audio Header

This header allows user to connect the front audio output cable with the PC front panel. This header allows only HD audio front panel connector; AC'97 connector is not acceptable.

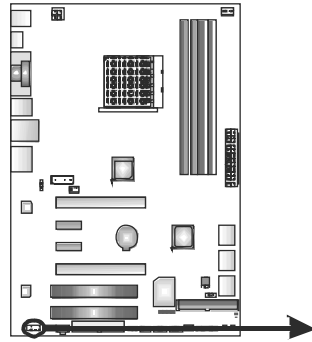

Pin	Assignment
1	Mic Left in
2	Ground
3	Mic Right in
4	GPIO
5	Right line in
6	Jack Sense
7	Front Sense
8	Key
9	Left line in
10	Jack Sense

CD_IN1: CD-ROM Audio-in Connector

This connector allows user to connect the audio source from the variety devices, like CD-ROM, DVD-ROM, PCI sound card, PCI TV turner card etc.

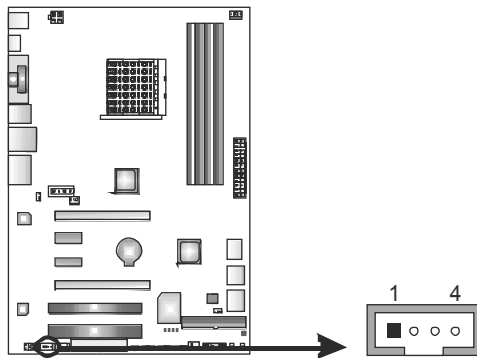

Pin	Assignment
1	Left Channel Input
2	Ground
3	Ground
4	Right Channel Input

SPDIF1: Digital Audio-out Connector

This connector allows user to connect the PCI bracket SPDIF output header.

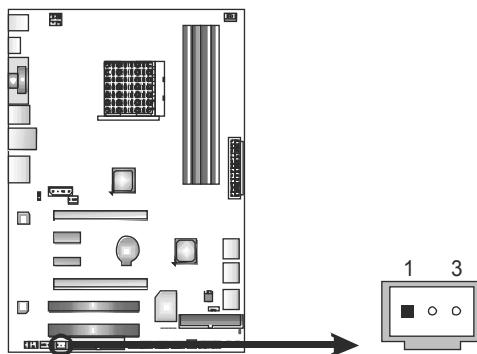

Pin	Assignment
1	+5V
2	SPDIF_OUT
3	Ground

On-Board LED Indicators

There are 6 LED indicators showing system status.

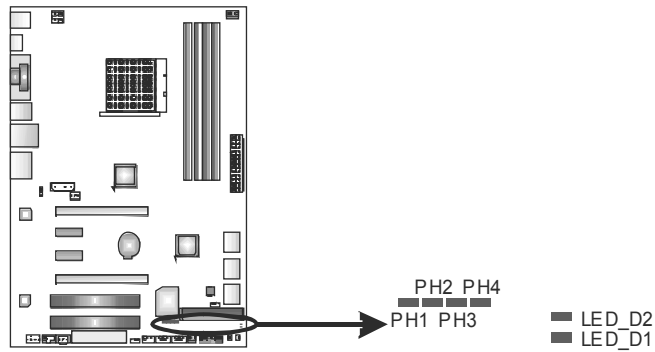

LED_D1 & LED_D2: Debug Indicators

PH1 ~ PH4: Power Status Indicators

Please refer to the tables below for specific messages:

LED_D1	LED_D2	Message
ON	ON	Normal
ON	OFF	Memory Error
OFF	ON	VGA Error
OFF	OFF	Abnormal: CPU / Chipset error.

PH1~PH4	Phase Indicator
ON	Phase Active
OFF	Phase Disable

On-Board Buttons

There are 2 on-board buttons.

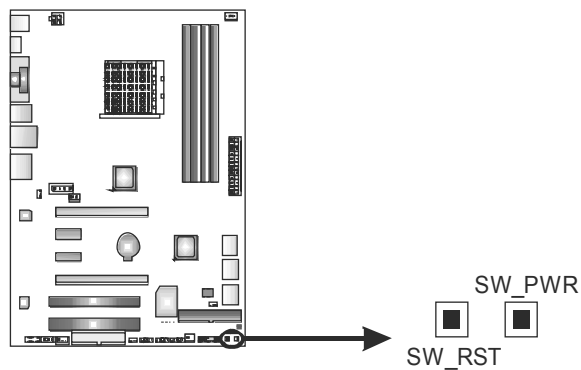

SW_RST: Reset button.

SW_PWR: Power Switch button.

JUSBV1/JUSBV2: Power Source Headers for USB Ports

Pin 1-2 Close:

JUSBV1: +5V for USB ports at USB1/RJ45USB1.

JUSBV2: +5V for USB ports at front panel (F_USB1~F_USB3).

Pin 2-3 Close:

JUSBV1: +5V STB for USB ports at USB1/ RJ45USB1.

JUSBV2: +5V STB for USB ports at front panel (F_USB1~F_USB3).

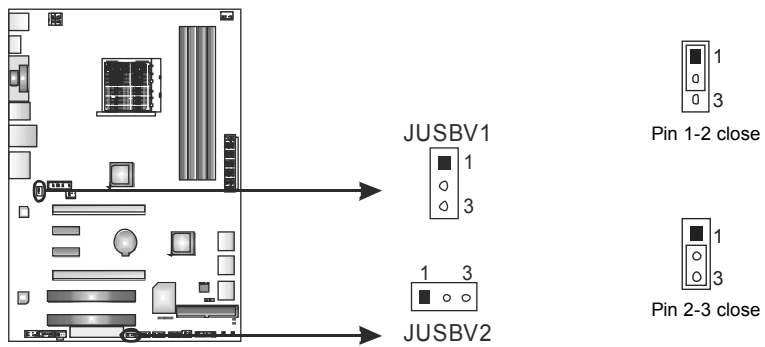

CHAPTER 4: (HYBRID) CROSSFIREX FUNCTION

4.1 CROSSFIREX REQUIREMENTS

- Only **Windows XP/Vista** supports CrossFireX (Dual Video) function.
- A pair of graphics cards with **Radeon HD3650/HD3850/HD3870/HD4850/HD4870/HD4670/HD4650/HD4350/HD4550/HD4830** GPU.
- The graphics card driver should support CrossFireX technology.
- The power supply unit must provide at least the minimum power required by the system, or the system will be unstable. A power supply above 500W is recommended under CrossFireX mode.
- **Note: Dual-core (x2) Graphics card is not supported.**

4.2 CROSSFIREX INSTALLATION

Step 1: Insert the two CrossFireX-Ready graphics cards into PEX16_1 (Master) and PEX16_2 (Slave)

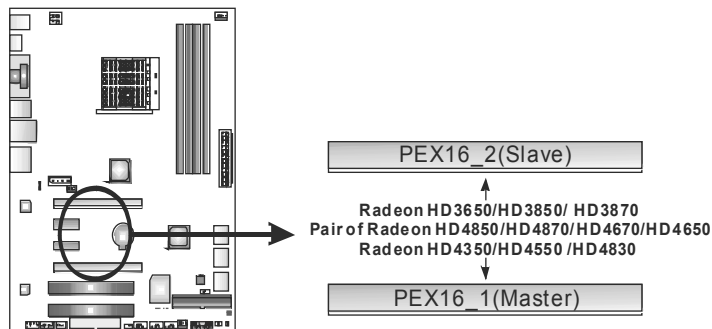

Notice: Make sure both the graphics cards are seated into slots completely.

Step 2: Connect a 4-pin ATX power cable to Auxiliary Power Connector (JATXPWR1), this will ensure the stabilization of your system.

Step 3: Connect the CrossFireX Bridge with two graphics cards. Installation completes.

NOTE

For more detail information of hardware/software installation and configuration of CrossFireX function, please visit following web-sites:

<http://ati.amd.com/technology/crossfire/tutorials.html>

<http://ati.amd.com/technology/crossfire/howitworksdemo.html>

4.3 HYBRID CROSSFIREX REQUIREMENTS

- Only **Windows Vista** supports Hybrid CrossFireX function.
- A graphics card with **Radeon HD3450/HD3470** GPU.
- The graphics card driver should support Hybrid CrossFireX technology.
- The power supply unit must provide at least the minimum power required by the system, or the system will be unstable. A power supply above 450W is recommended under Hybrid CrossFireX mode.

4.4 HYBRID CROSSFIREX INSTALLATION

Step 1: Insert the Hybrid CrossFireX-Ready graphics card into PEX16_1 (Master), and insert the DCCFX-P2 Paddle Card into PEX16_2 (Slave).

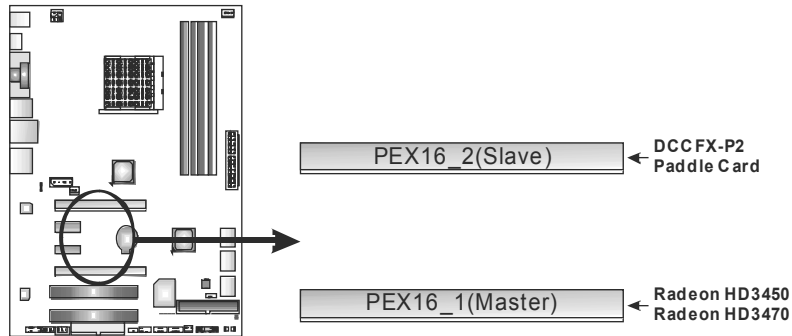

Notice: Make sure both cards are seated into slots completely.

Step 2: Connect a 4-pin ATX power cable to Auxiliary Power Connector (AUXPWR1), this will ensure the stabilization of your system.

Step 3: In the graphics card configuration program, choose “Hybrid CrossFireX” function. Installation completes.

NOTE

For more detail information of Hybrid CrossFireX function, please visit following web-sites:

http://game.amd.com/us-en/crossfirex_hybrid.aspx

<http://ati.amd.com/technology/hybridgraphics/index.html>

4.5 OPERATION MODES SUPPORTING LIST

Operation Mode Model	Single Card	CrossFireX	Hybrid CrossFireX
Radeon HD3650	O	O	X
Radeon HD3850	O	O	X
Radeon HD3870	O	O	X
Radeon HD4850	O	O	X
Radeon HD4870	O	O	X
Radeon HD3450	O	X	O
Radeon HD3470	O	X	O
Radeon HD3870X2	O	X	X

(O means Supported, X means Not Supported.)

CHAPTER 5: RAID FUNCTIONS

5.1 OPERATING SYSTEM

Supports Windows XP and Windows VISTA.

5.2 RAID ARRAYS

RAID supports the following types of RAID arrays:

RAID 0: RAID 0 defines a disk striping scheme that improves disk read and write times for many applications.

RAID 1: RAID 1 defines techniques for mirroring data.

RAID 1+0: RAID 1+0 combines the techniques used in RAID 0 and RAID 1.

RAID 5: RAID 5 provides fault tolerance and better utilization of disk capacity.

5.3 How RAID WORKS

RAID 0:

The controller “stripes” data across multiple drives in a RAID 0 array system. It breaks up a large file into smaller blocks and performs disk reads and writes across multiple drives in parallel. The size of each block is determined by the stripe size parameter, which you set during the creation of the RAID set based on the system environment. This technique reduces overall disk access time and offers high bandwidth.

Features and Benefits

- **Drives:** Minimum 2, and maximum is up to 6 or 8. Depending on the platform.
- **Uses:** Intended for non-critical data requiring high data throughput, or any environment that does not require fault tolerance.
- **Benefits:** provides increased data throughput, especially for large files. No capacity loss penalty for parity.
- **Drawbacks:** Does not deliver any fault tolerance. If any drive in the array fails, all data is lost.
- **Fault Tolerance:** No.

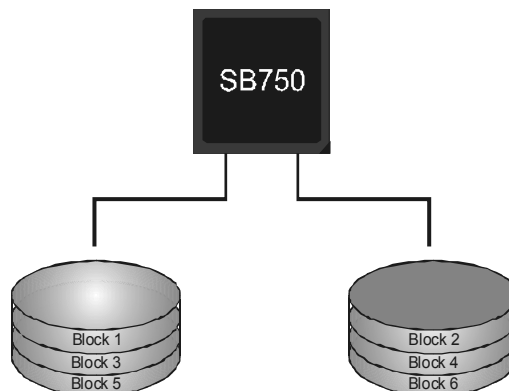

RAID 1:

Every read and write is actually carried out in parallel across 2 disk drives in a RAID 1 array system. The mirrored (backup) copy of the data can reside on the same disk or on a second redundant drive in the array. RAID 1 provides a hot-standby copy of data if the active volume or drive is corrupted or becomes unavailable because of a hardware failure. RAID techniques can be applied for high-availability solutions, or as a form of automatic backup that eliminates tedious manual backups to more expensive and less reliable media.

Features and Benefits

- **Drives:** Minimum 2, and maximum is 2.
- **Uses:** RAID 1 is ideal for small databases or any other application that requires fault tolerance and minimal capacity.
- **Benefits:** Provides 100% data redundancy. Should one drive fail, the controller switches to the other drive.
- **Drawbacks:** Requires 2 drives for the storage space of one drive. Performance is impaired during drive rebuilds.
- **Fault Tolerance:** Yes.

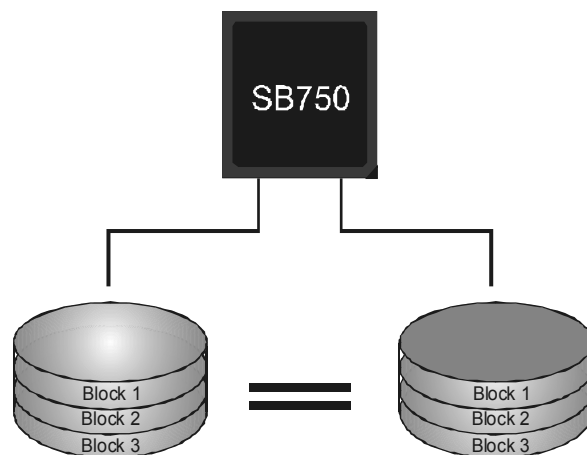

RAID 1+0:

RAID 1 drives can be striped using RAID 0 techniques. Resulting in a RAID 1+0 solution for improved resiliency, performance and rebuild performance.

Features and Benefits

- **Drives:** Minimum 4, and maximum is 6 or 8, depending on the platform.
- **Benefits:** Optimizes for both fault tolerance and performance, allowing for automatic redundancy. May be simultaneously used with other RAID levels in an array, and allows for spare disks.
- **Drawbacks:** Requires twice the available disk space for data redundancy, the same as RAID level 1.
- **Fault Tolerance:** Yes.

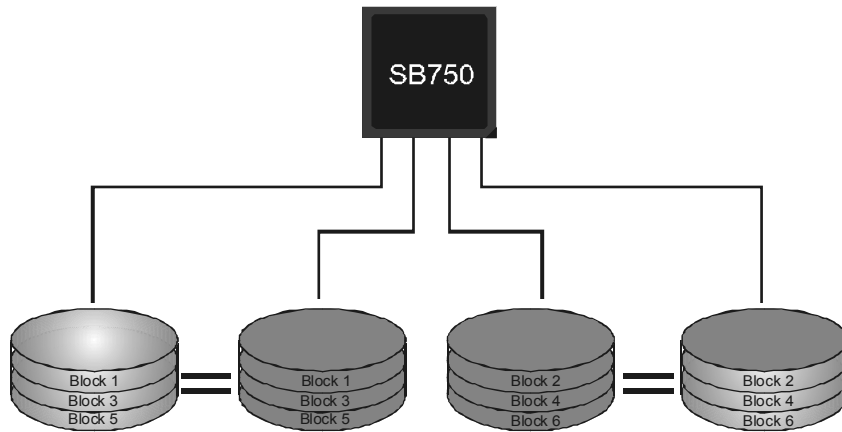

RAID 5:

RAID 5 stripes both data and parity information across three or more drives. It writes data and parity blocks across all the drives in the array. Fault tolerance is maintained by ensuring that the parity information for any given block of data is placed on a different drive from those used to store the data itself.

Features and Benefits

- **Drives:** Minimum 3.
- **Uses:** RAID 5 is recommended for transaction processing and general purpose service.
- **Benefits:** An ideal combination of good performance, good fault tolerance, and high capacity and storage efficiency.
- **Drawbacks:** Individual block data transfer rate same as a single disk. Write performance can be CPU intensive.
- **Fault Tolerance:** Yes.



CHAPTER 6: T-SERIES BIOS & SOFTWARE

6.1 T-SERIES BIOS

T-Series BIOS Features

- Overclocking Navigator Engine (O.N.E.)
- Memory Integration Test (M.I.T., under Overclock Navigator Engine)
- BIO-Flasher: Update BIOS file from USB Flash Drive or FDD
- Self Recovery System (S.R.S)
- Smart Fan Function
- CMOS Reloading Program

!! WARNING !!

For better system performance, the BIOS firmware is being continuously updated. The BIOS information described below in this manual is for your reference only and the actual BIOS information and settings on board may be different from this manual. For further information of setting up the BIOS, please refer to the BIOS Manual in the Setup CD.

A. Overclocking Navigator Engine (O.N.E.)

ONE provides two powerful overclocking engines: MOS and AOS for both Elite and Casual overclockers.

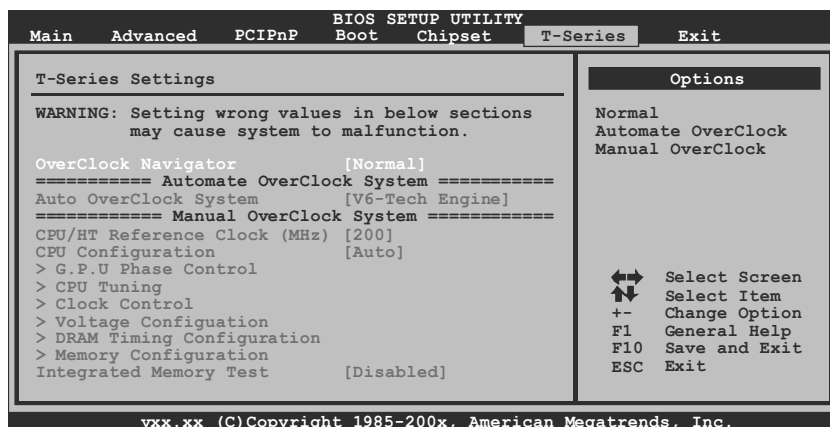

Manual Overclock System (M.O.S.)

MOS is designed for experienced overclock users.
It allows users to customize personal overclock settings.

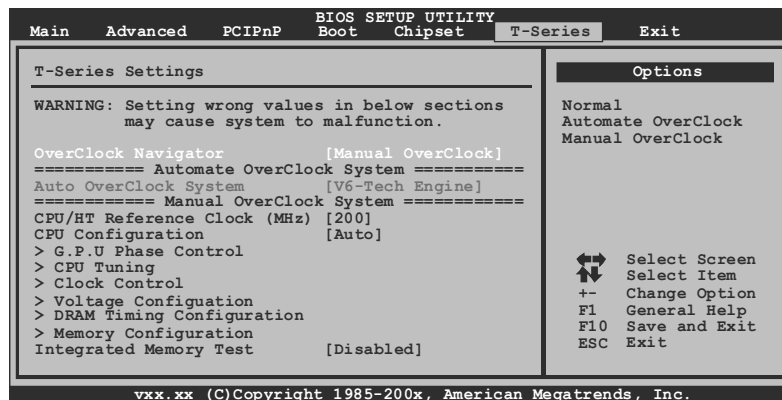
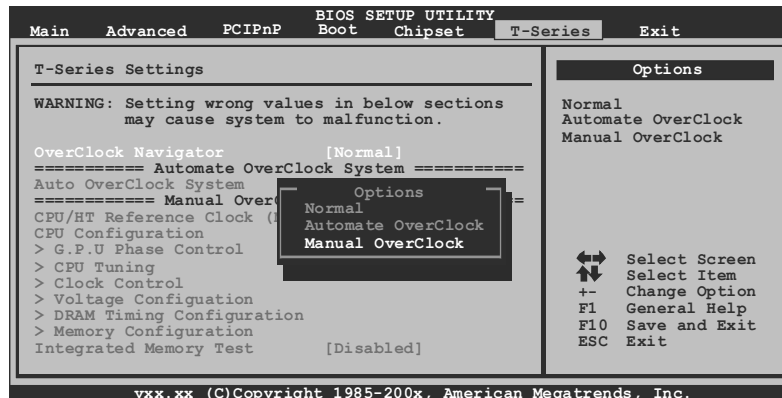

CPU/HT Reference Clock (MHz)

CPU Frequency is directly in proportion to system performance. To maintain the system stability, CPU voltage needs to be increased also when raising CPU frequency.

CPU Configuration

This item provides several fixed modes of CPU configuration.

G.P.U Phase Control

Enter this function for more power saving settings.

Motherboard Manual

CPU Tuning

Enter this function for more advanced CPU settings.

Clock Control

Enter this function for more clock settings.

Voltage Configuration

Enter this function for more advanced voltage settings.

DRAM Timing Configuration

Enter this function for more advanced DRAM clock settings.

Memory Configuration

Enter this function for more advanced memory settings.

NOTE

Overclocking is not a necessary process for computers. Therefore, we will not be responsible for any hardware damage which may be caused by overclocking. We also will not guarantee any overclocking performance.

Automatic Overclock System (A.O.S.)

For beginners, BET had developed an easy, fast, and powerful feature to improve the system performance, named A.O.S.

Based on many tests and experiments, A.O.S. provides 3 ideal overclock configurations to improve system performance with a single step.

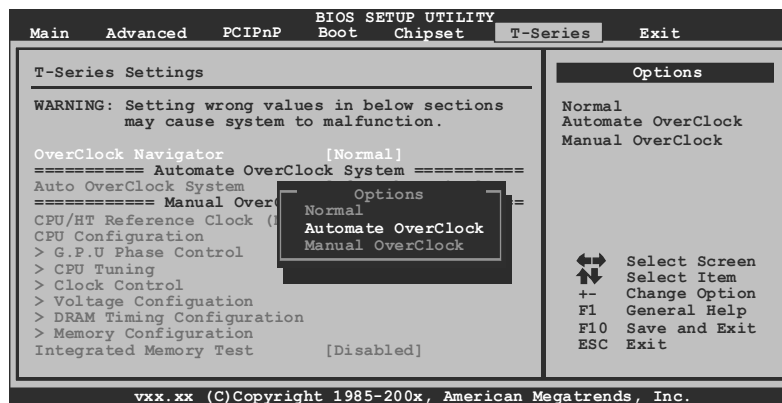

V6 Tech Engine

This engine will make a good over-clock performance.

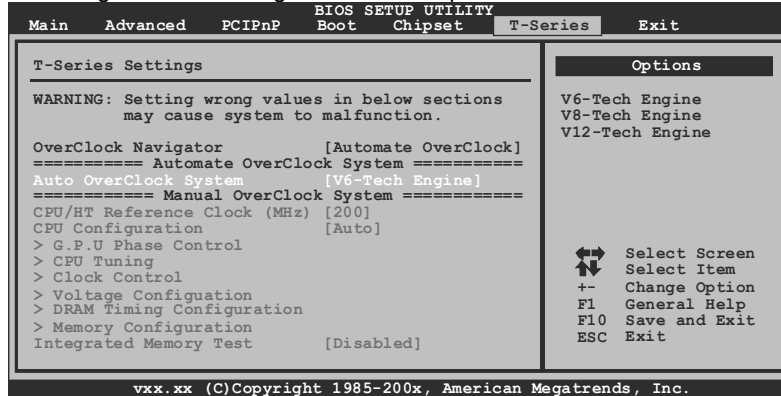

V8 Tech Engine

This engine will make a better over-clock performance.

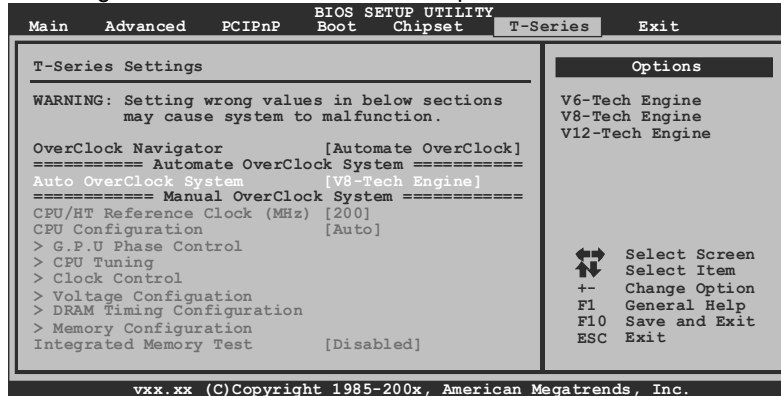

V12 Tech Engine

This engine will make a best over-clock performance.

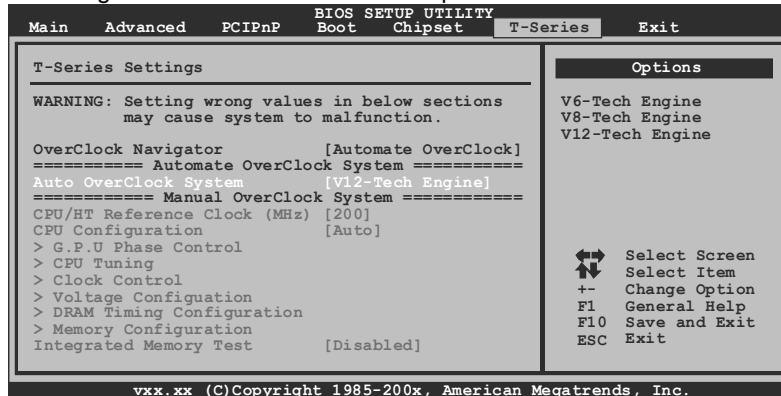

Notices:

Not all types of AMD CPU perform above overclock setting ideally; the difference will be based on the selected CPU model.

B. Memory Integration Test (M.I.T.)

This function is under “Overclocking Navigator Engine” item.

MIT allows users to test memory compatibilities, and no extra devices or software are needed.

Step 1

The default setting under this item is “Disabled”; the condition parameter should be changed to “Enable” to proceed this test.

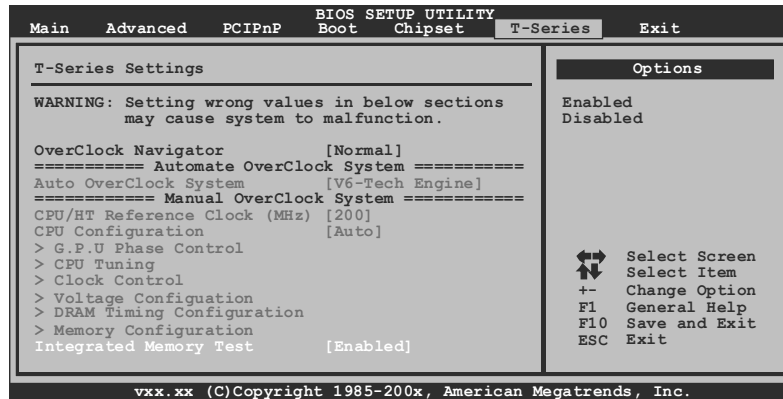
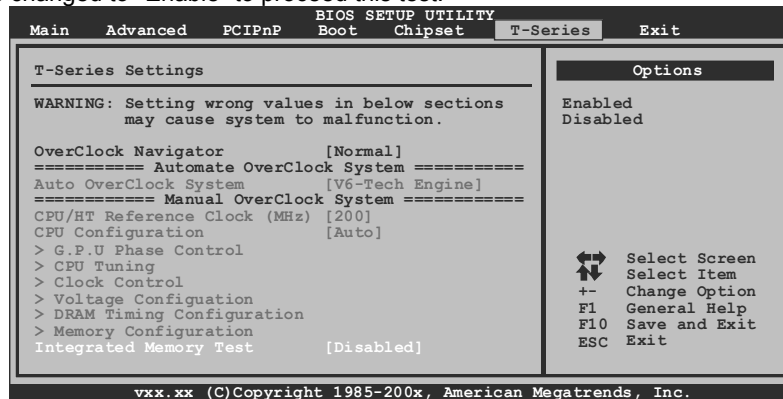

Step 2

Save and Exit from CMOS setup and reboot the system to activate this test.

Run this test for 5 minutes (minimum) to ensure the memory stability.

Step 3

When the process is done, change the setting back from “Enable” to “Disable” to complete the test.

C. BIO-Flasher

BIO-Flasher is a BIOS flashing utility providing you an easy and simple way to update your BIOS via USB pen drive or floppy disk.

The BIO-Flasher is built in the BIOS chip. To enter the utility, **press <F12> during the Power-On Self Tests (POST)** procedure while booting up.

Updating BIOS with BIO-Flasher

1. Go to the website to download the latest BIOS file for the motherboard.
2. Then, save the BIOS file into a USB pen drive or a floppy disk.
3. Insert the USB pen drive or the floppy disk that contains the BIOS file to the USB port or the floppy disk drive.
4. Power on or reset the computer and then press **<F12>** during the **POST** process. A select dialog as the picture on the right appears. Select the device contains the BIOS file and press **<Enter>** to enter the utility.



5. The utility will show the BIOS files and their respective information. Select the proper BIOS file and press **<Enter>** then **<Y>** to perform the BIOS update process.

6. After the update process, the utility will ask you to reboot the system. Press **<Y>** to proceed. BIOS update completes.



- This utility only allows storage device with FAT32/16 format and single partition.
- Shutting down or resetting the system while updating the BIOS will lead to system boot failure.

D. Self Recovery System (S.R.S.)

This function can't be seen under BIOS setup; and is always on whenever the system starts up.

However, it can prevent system hang-up due to inappropriate overclock actions.

When the system hangs up, S.R.S. will automatically log in the default BIOS setting, and all overclock settings will be re-configured.

E. Smart Fan Function

Smart Fan Function is under "Smart Fan Configuration" in "Advanced Menu".

This is a brilliant feature to control CPU/System Temperature vs. Fan speed.

When enabling Smart Fan function, Fan speed is controlled automatically by CPU/System temperature.

This function will protect CPU/System from overheat problem and maintain the system temperature at a safe level.

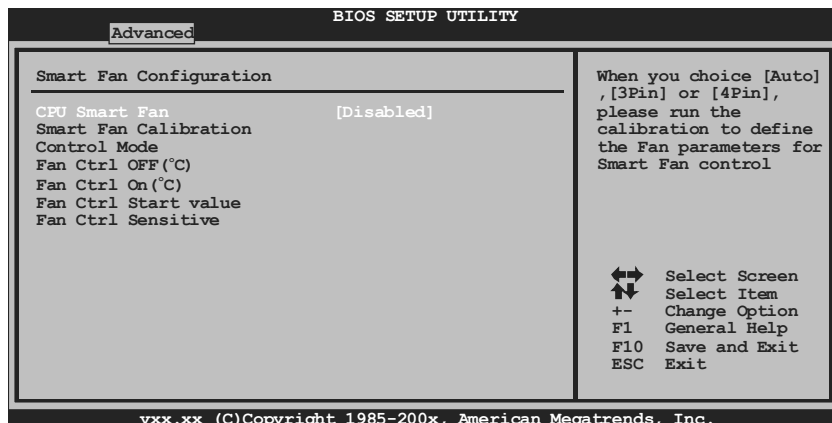
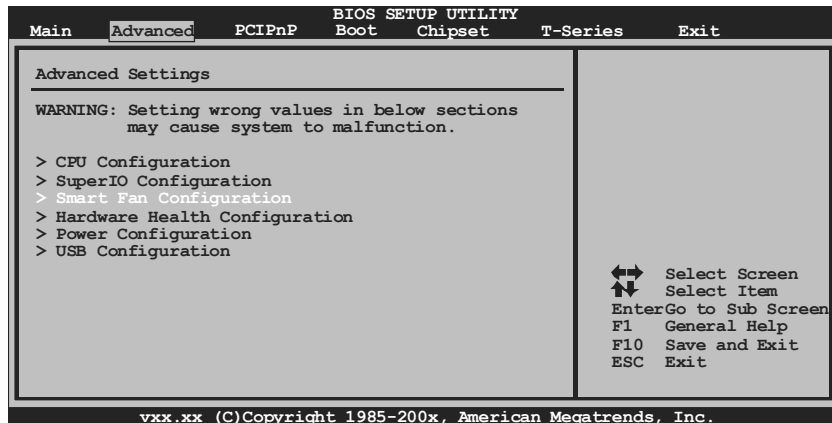

Smart Fan Calibration

Choose this item and then the BIOS will automatically test and detect the CPU/System fan functions and show CPU/System fan speed.

Control Mode

This item provides several operation modes of the fan.

Fan Ctrl OFF(°C)

If the CPU/System temperature is lower than the set value, the CPU/System fan will turn off. The range is from 0~127, with an interval of 1.

Fan Ctrl On(°C)

The CPU/System fan starts to work when CPU/System temperature arrives to this set value. The range is from 0~127, with an interval of 1.

Fan Ctrl Start Value

When CPU/System temperature arrives to the set value, the CPU/System fan will work under Smart Fan Function mode. The range is from 0~127, with an interval of 1.

Fan Ctrl Sensitive

Increasing the value of slope PWM will raise the speed of CPU/System fan. The range is from 1~127, with an interval of 1.

F. CMOS Reloading Program

It allows users to save different CMOS settings into BIOS-ROM. Users are able to reload any saved CMOS setting for customizing system configurations. Moreover, users are able to save an ideal overclock setting during overclock operation. There are 10 sets of record addresses in total, and users are able to name the CMOS data according to personal preference.

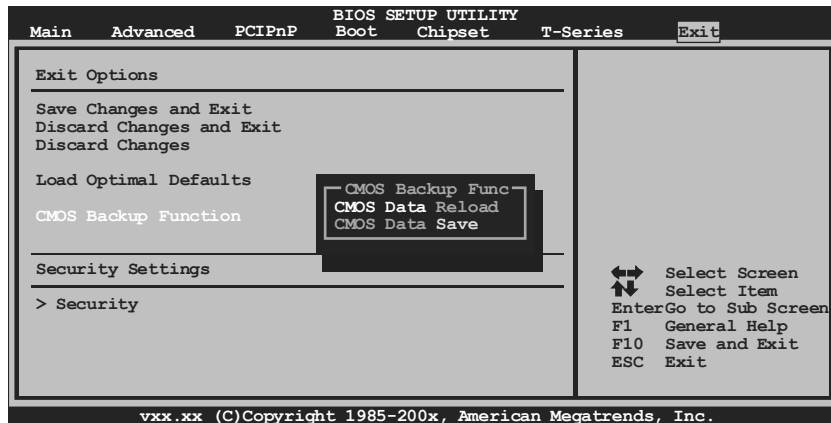

6.2 T-SERIES SOFTWARE

Installing T-Series Software

1. Insert the Setup CD to the optical drive. The drivers installation program would appear if the Auto-run function has been enabled.
2. Select **Software Installation**, and then click on the respective software title.
3. Follow the on-screen instructions to complete the installation.

Launching T-Series Software

After the installation process, you will see the software icon “T-Utility OverClock III” / “HW Monitor” / “eHOT Line” / “Tseries BIOS Update” appears on the desktop. Double-click the icon to launch T-Series utility.

OverClock 3

OverClock 3 is equipped with friendly interface and solid over-clock features, and it will help you easily do over-clocking under windows environment.

Double-click the desktop icon, OverClock 3 will be launched; the first window you will see is **Main Panel**. In this panel you will see current CPU Speed and CPU/Memory/PCI-E/PCI Clock.

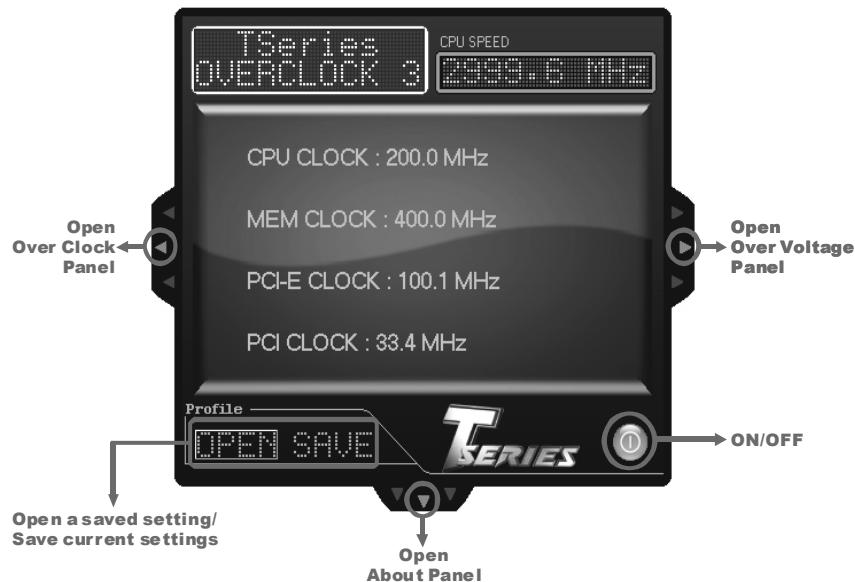

Over Clock Panel

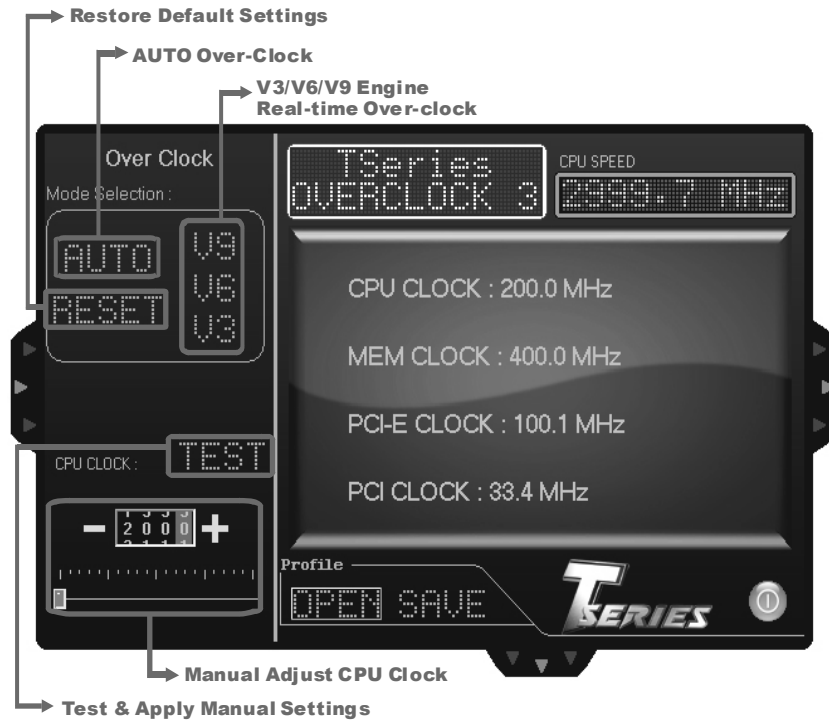

AUTO

User can click this button and the utility will set the best and stable performance and frequency automatically. A warning dialog as below will show up to notify you that the system may become unstable, click on "OK" to continue.

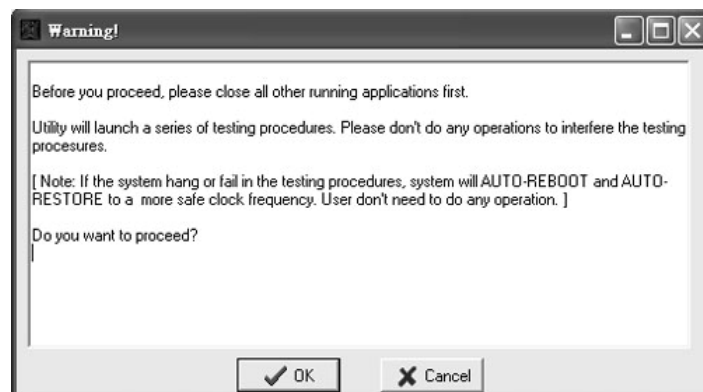

Then the utility will execute a series of testing until system fail. Then system will do fail-safe reboot by using Watchdog function. After reboot, launch the utility again and the utility will load the previously verified best and stable frequency.

V3 / V6 / V9

Provide user the ability to do real-time over-clock adjustment. For beginners in over-clock field, this is a powerful feature to increase system performance.

- **V3 Engine**
This engine will make a good over-clock performance.
- **V6 Engine**
This engine will make a better over-clock performance.
- **V9 Engine**
This engine will make a best over-clock performance.

TEST

You can also manually adjust CPU clock by pressing +/- button or moving the level bar. After manually adjust the CPU clock, you should click TEST button and the utility will proceed a testing for current frequency. If the testing is ok, then the current frequency will be saved into system registry. If the testing fails, system will do a fail-safe rebooting. After reboot, the utility will restore to the hardware default setting.

Warning

Manually over-clock is potentially dangerous, especially when the over-clocking percentage is over 110 %. We strongly recommend you test every speed you over-clock by click the TEST button. Or, you can just click AUTO over-clock button and let the Utility automatically get the best result for you.

RESET

Click this button and the utility will restore all values to the hardware default setting.

Over Voltage Panel

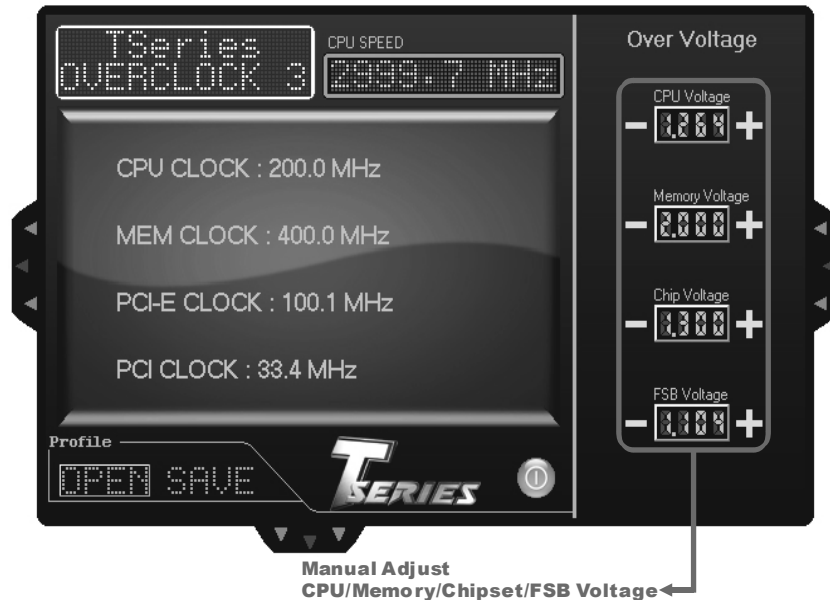

CPU Voltage

This function allows user to adjust CPU voltage. Click on “+” to increase or “-” to decrease the CPU voltage.

Memory Voltage

This function allows user to adjust Memory voltage. Click on “+” to increase or “-” to decrease the Memory voltage.

Chip Voltage

This function allows user to adjust Chipset voltage. Click on “+” to increase or “-” to decrease the Chipset voltage.

FSB Voltage

This function allows user to adjust FSB voltage. Click on “+” to increase or “-” to decrease the FSB voltage.

About Panel

In this panel, you can get model name and other system information that may related to over-clocking. You can also get the version number of this software.

Note

Because the Over Clock and Over Voltage features are controlled by several separate chipset, the utility divides these features to separate panels. If one chipset is not on board, the correlative button in Main panel will be disabled, but it will not interfere with other panels' functions. This property can make the utility more robust.

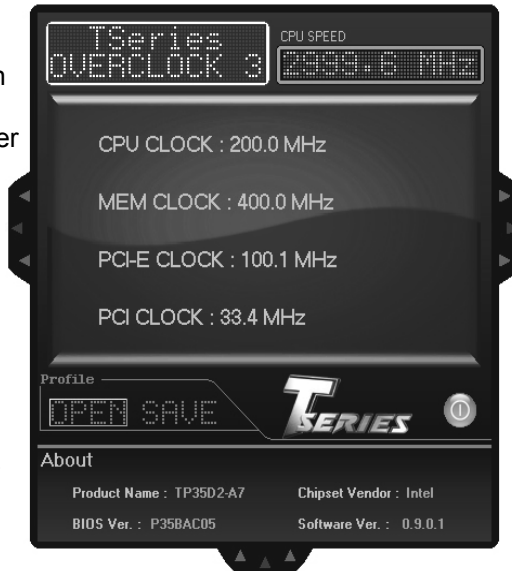

Hardware Monitor

HW Monitor is a monitor utility that helps you to maintain the health of the PC. It provides real-time information of CPU/GPU/System temperature, fan speed, and voltage.

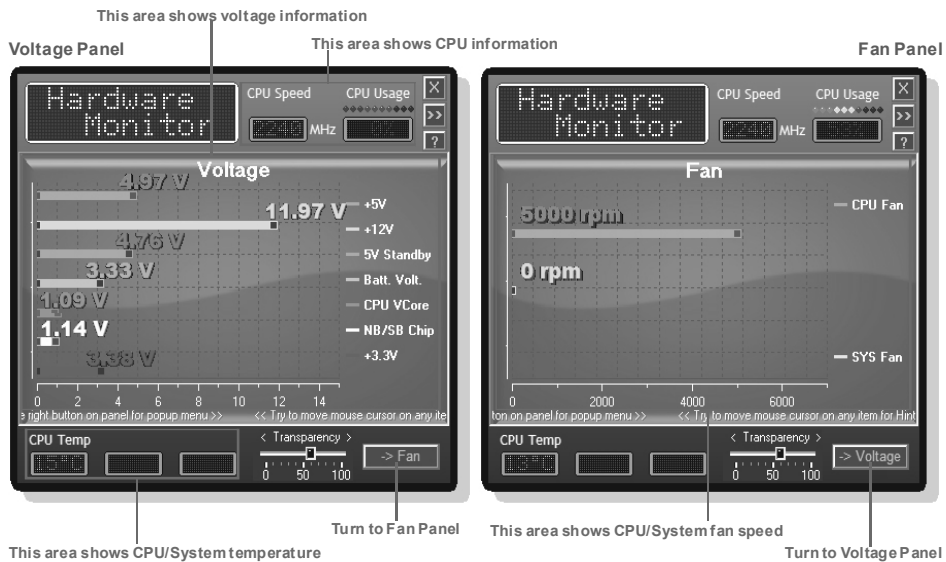

eHot-Line (Optional)

eHot-Line is a convenient utility that helps you to contact with our Tech-Support system. This utility will collect the system information which is useful for analyzing the problem you may have encountered, and then send these information to our tech-support department to help you fix the problem.

 Before you use this utility, please set Outlook Express as your default e-mail client application program.

* represents important information that you must provide. Without this information, you may not be able to send out the mail.

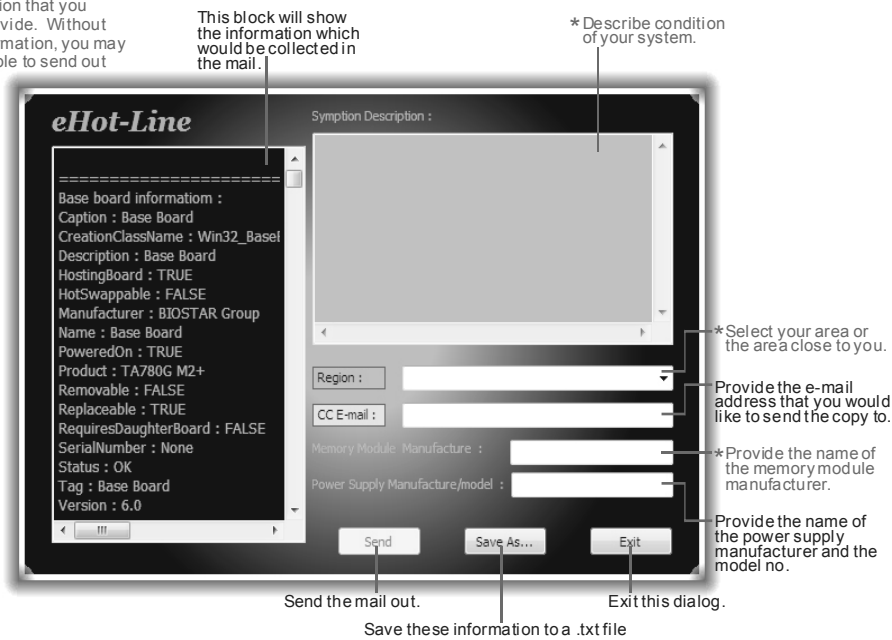

This block will show the information which would be collected in the mail.

* Describe condition of your system.

* Select your area or the area close to you.

Provide the e-mail address that you would like to send the copy to.

* Provide the name of the memory module manufacturer.

Provide the name of the power supply manufacturer and the model no.

Send the mail out.

Save these information to a .txt file

Exit this dialog.

After filling up this information, click **“Send”** to send the mail out. A warning dialog would appear asking for your confirmation; click **“Send”** to confirm or **“Do Not Send”** to cancel.



If you want to save this information to a .txt file, click **“Save As...”** and then you will see a saving dialog appears asking you to enter file name.

Enter the file name and then click “Save”. Your system information will be saved to a .txt file.

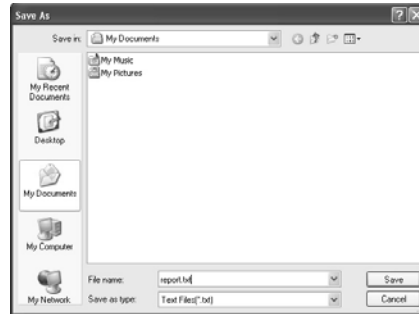

Open the saved .txt file, you will see your system information including motherboard/BIOS/CPU/video/device/OS information. This information is also included in the sent mail.



We will not share customer’s data with any other third parties, so please feel free to provide your system information while using eHot-Line service.



If you are not using Outlook Express as your default e-mail client application, you may need to save the system information to a .txt file and send the file to our tech support with other e-mail application. Go to the following web <http://www.biostar.com.tw/app/en-us/about/contact.php> for getting our contact information.

BIOS Update

BIOS Update is a convenient utility which allows you to update your motherboard BIOS under Windows system.

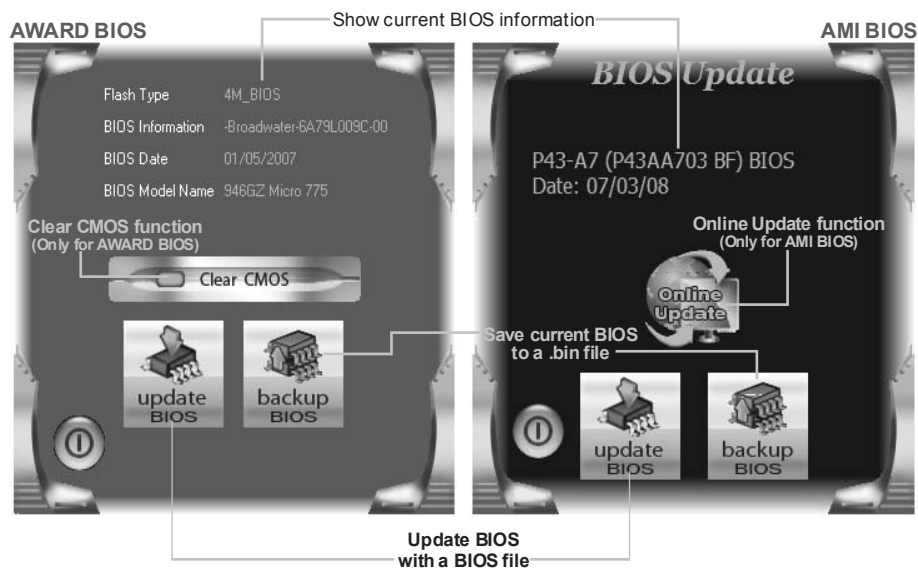

<Backup BIOS>

Once click on this button, the saving dialog will show. Choose the position to save file and enter file name. (We recommend that the file name should be English/number and no longer than 7 characters.) Then click **Save**.

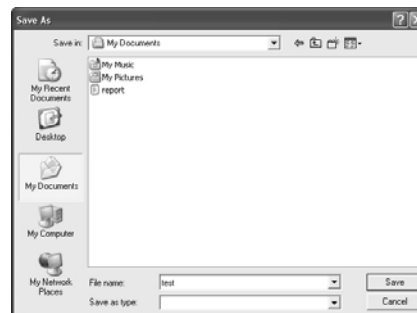

After the saving process, finish dialog will show. Click on **OK** to complete the BIOS Backup procedure.

<Update BIOS>

Before doing this, please download the proper BIOS file from the website.

For AWARD BIOS, update BIOS procedure should be run with Clear CMOS function, so please check on Clear CMOS first.

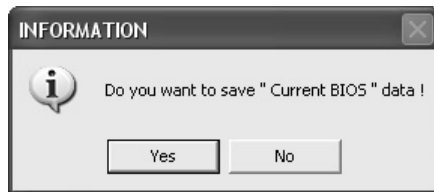
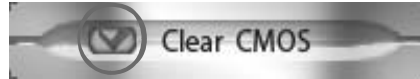

Then click Update BIOS button, a dialog will show for asking you backup current BIOS. Click **Yes** for BIOS backup and refer to the Backup BIOS procedure; or click **No** to skip this procedure.

After the BIOS Backup procedure, the open dialog will show for requesting the BIOS file which is going to be updated. Please choose the proper BIOS file for updating, then click on **Open**.

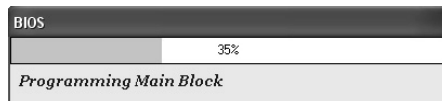
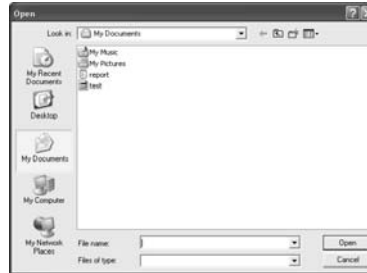

The utility will update BIOS with the proper BIOS file, and this process may take minutes. Please do not open any other applications during this process.

After the BIOS Update process, click on **OK** to restart the system.

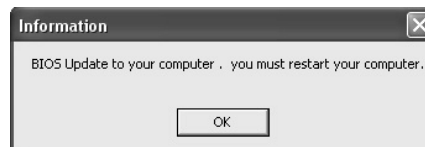

While the system boots up and the full screen logo shows, press  <Delete> key to enter BIOS setup.

In the BIOS setup, use the **Load Optimized Defaults** function and then **Save and Exit Setup** to exit BIOS setup. BIOS Update is completed.

<Online Update> (for AMI BIOS only)

Automatically download and update the latest BIOS via internet; **make sure that the computer is connected to the internet before using this function.**

After clicking on the **Online Update** button, the utility will search for the latest BIOS from internet. If there is a new BIOS version, the utility will ask you to download it. Click **Yes** to proceed.

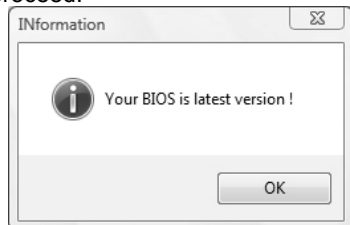
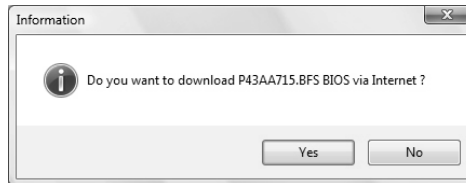

If there is no other newer BIOS version, the utility will also tell you that your BIOS has been the latest version.

Download completes; the utility will ask you to program (update) the BIOS. Click **Yes** to proceed.

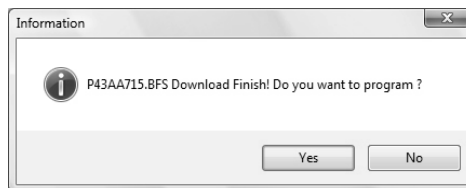

The programming procedure may take minutes, **please do not make any operation during the programming process.**

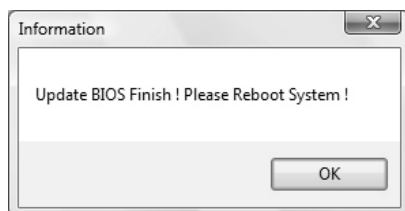

After the updating process, the utility will ask you to reboot the system. Click **OK** to reboot.

While the system boots up and the full screen logo shows, press  <Delete> key to enter BIOS setup.

In the BIOS setup, use the **Load Optimized Defaults** function and then **Save and Exit Setup** to exit BIOS setup. Online Update is completed.



All the information and content above about the T-Series software are subject to be changed without notice. For better performance, the software is being continuously updated. The information and pictures described above are for your reference only. The actual information and settings on board may be slightly different from this manual.

CHAPTER 7: USEFUL HELP

7.1 DRIVER INSTALLATION NOTE

After you installed your operating system, please insert the Fully Setup Driver CD into your optical drive and install the driver for better system performance.

You will see the following window after you insert the CD

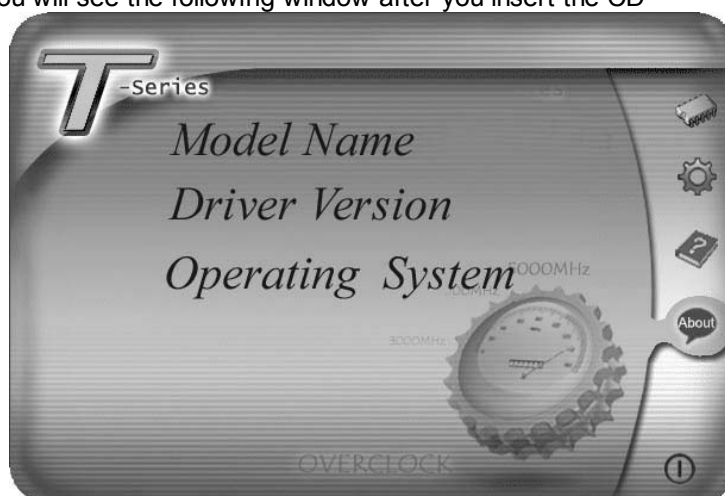

The setup guide will auto detect your motherboard and operating system.

Note:

If this window didn't show up after you insert the Driver CD, please use file browser to locate and execute the file **SETUP.EXE** under your optical drive.

A. Driver Installation

To install the driver, please click on the Driver icon. The setup guide will list the compatible driver for your motherboard and operating system. Click on each device driver to launch the installation program.

B. Software Installation

To install the software, please click on the Software icon. The setup guide will list the software available for your system, click on each software title to launch the installation program.

C. Manual

Aside from the paperback manual, we also provide manual in the Driver CD. Click on the Manual icon to browse for available manual.

Note:

You will need Acrobat Reader to open the manual file. Please download the latest version of Acrobat Reader software from <http://www.adobe.com/products/acrobat/readstep2.html>

7.2 EXTRA INFORMATION

CPU Overheated

If the system shutdown automatically after power on system for seconds, that means the CPU protection function has been activated.

When the CPU is over heated, the motherboard will shutdown automatically to avoid a damage of the CPU, and the system may not power on again.

In this case, please double check:

1. The CPU cooler surface is placed evenly with the CPU surface.
2. CPU fan is rotated normally.
3. CPU fan speed is fulfilling with the CPU speed.

After confirmed, please follow steps below to relief the CPU protection function.

1. Remove the power cord from power supply for seconds.
2. Wait for seconds.
3. Plug in the power cord and boot up the system.

Or you can:

1. Clear the CMOS data.
(See "Close CMOS Header: JCMOS1" section)
2. Wait for seconds.
3. Power on the system again.

7.3 AMI BIOS BEEP CODE

Boot Block Beep Codes

Number of Beeps	Description
1	No media present. (Insert diskette in floppy drive A:)
2	"AMIBOOT.ROM" file not found in root directory of diskette in A:
3	Insert next diskette if multiple diskettes are used for recovery
4	Flash Programming successful
5	File read error
7	No Flash EPROM detected
10	Flash Erase error
11	Flash Program error
12	"AMIBOOT.ROM" file size error
13	BIOS ROM image mismatch (file layout does not match image present in flash device)

POST BIOS Beep Codes

Number of Beeps	Description
1	Memory refresh timer error
3	Base memory read/write test error
6	Keyboard controller BAT command failed
7	General exception error (processor exception interrupt error)
8	Display memory error (system video adapter)

Troubleshooting POST BIOS Beep Codes

Number of Beeps	Troubleshooting Action
1, 3	Reseat the memory, or replace with known good modules.
6, 7	<p>Fatal error indicating a serious problem with the system. Consult your system manufacturer. Before declaring the motherboard beyond all hope, eliminate the possibility of interference by a malfunctioning add-in card. Remove all expansion cards except the video adapter.</p> <ul style="list-style-type: none"> ● If beep codes are generated when all other expansion cards are absent, consult your system manufacturer's technical support. ● If beep codes are not generated when all other expansion cards are absent, one of the add-in cards is causing the malfunction. Insert the cards back into the system one at a time until the problem happens again. This will reveal the malfunctioning card.
8	If the system video adapter is an add-in card, replace or reseat the video adapter. If the video adapter is an integrated part of the system board, the board may be faulty.

7.4 TROUBLESHOOTING

Probable	Solution
1. There is no power in the system. Power LED does not shine; the fan of the power supply does not work 2. Indicator light on keyboard does not shine.	1. Make sure power cable is securely plugged in. 2. Replace cable. 3. Contact technical support.
System is inoperative. Keyboard lights are on, power indicator lights are lit, and hard drives are running.	Using even pressure on both ends of the DIMM, press down firmly until the module snaps into place.
System does not boot from a hard disk drive, but can be booted from optical drive.	1. Check cable running from disk to disk controller board. Make sure both ends are securely plugged in; check the drive type in the standard CMOS setup. 2. Backing up the hard drive is extremely important. All hard disks are capable of breaking down at any time.
System only boots from an optical drive. Hard disks can be read, applications can be used, but system fails to boot from a hard disk.	1. Back up data and applications files. 2. Reformat the hard drive. Re-install applications and data using backup disks.
Screen message shows "Invalid Configuration" or "CMOS Failure."	Review system's equipment. Make sure correct information is in setup.
System cannot boot after user installs a second hard drive.	1. Set master/slave jumpers correctly. 2. Run SETUP program and select correct drive types. Call the drive manufacturers for compatibility with other drives.

APPENDIX: SPEC IN OTHER LANGUAGES**GERMAN**

<i>Spezifikationen</i>		
CPU	Sockel AM2+ / AM3 AMD Athlon 64 / Athlon 64 FX / Athlon 64 X2 / Sempron / Phenom / Phenom II Prozessoren	Die AMD 64-Architektur unterstützt eine 32-Bit- und 64-Bit-Datenverarbeitung Unterstützt Hyper Transport 3.0 und PowerNow
FSB	Unterstützt HyperTransport 3.0 mit einer Bandbreite von bis zu 5.2 GT/s	
Chipsatz	AMD 790GX AMD SB750	
Super E/A	ITE 8718 Bietet die häufig verwendeten alten Super E/A-Funktionen. Low Pin Count-Schnittstelle	Umgebungskontrolle, Hardware-Überwachung Lüfterdrehzahl-Controller "Smart Guardian"-Funktion von ITE
Arbeitsspeicher	DDR2 DIMM-Steckplätze x 4 Max. 16GB Arbeitsspeicher Jeder DIMM unterstützt 256MB/512MB/ 1GB/2GB/4GB DDR2.	Dual-Kanal DDR2 Speichermodul Unterstützt DDR2 533 / 667 / 800 Unterstützt DDR2 1066 (by AM2+ / AM3 CPU) registrierte DIMMs. ECC DIMMs werden nicht unterstützt.
Grafik	Radeon HD 3300	Onboard side port memory 128MB DDR2 Max. 512MB gemeinsam benutzter Videospeicher Unterstützt DX10/UVD/HDCP Unterstützt (Hybrid) CrossFireX (by ATI driver)
IDE	AMD SB750	Ultra DMA 33 / 66 / 100 / 133 Bus Master-Modus Unterstützt PIO-Modus 0~4,
SATA II	AMD SB750	Datentransferrate bis zu 3Gb/s Konform mit der SATA-Spezifikation Version 2.0. Unterstützt RAID 0,1,5,1+0
LAN	Realtek RTL 8111DL	10 / 100 / 1000 Mb/s Auto-Negotiation Halb- / Vollduplex-Funktion
Audio-Codec	ALC888	7.1-Kanal-Audioausgabe Unterstützt High-Definition Audio

Spezifikationen			
Steckplätze	PCI Steckplatz	x2	
	PCI Express Gen2 x16 Steckplatz	x2	
	PCI Express Gen2 x1 Steckplatz	x2	
Onboard-Anschluss	Diskettenlaufwerkanschluss	x1	Jeder Anschluss unterstützt 2 Diskettenlaufwerke
	Druckeranschluss	x1	Jeder Anschluss unterstützt 1 Druckeranschluss
	IDE-Anschluss	x1	Jeder Anschluss unterstützt 2 IDE-Laufwerke
	SATA-Anschluss	x6	Jeder Anschluss unterstützt 1 SATA-Laufwerk
	Fronttafelanschluss	x1	Unterstützt die Fronttafel-Funktionen
	Front-Audioanschluss	x1	Unterstützt die Fronttafel-Audioanschlussfunktion
	CD-IN-Anschluss	x1	Unterstützt die CD Audio-In-Funktion
	S/PDIF Ausgangsanschluss	x1	Unterstützt die digitale Audioausgabefunktion
	CPU-Lüfter-Sockel	x1	CPU-Lüfterstromversorgungsanschluss (mit Smart Fan-Funktion)
	System-Lüfter-Sockel	x2	System-Lüfter-Stromversorgungsanschluss
	"CMOS löschen"-Sockel	x1	
Rückseiten-E/A	USB-Anschluss	x3	Jeder Anschluss unterstützt 2 Fronttafel-USB-Anschlüsse
	Stromanschluss (24-polig)	x1	
	Stromanschluss (4-polig)	x2	
	PS/2-Tastatur	x1	
	PS/2-Maus	x1	
Rückseiten-E/A	HDMI-Anschluss	x1	
	VGA-Anschluss	x1	
	DVI-D-Anschluss	x1	
	LAN-Anschluss	x1	
	USB-Anschluss	x4	
Platinengröße	Audioanschluss	x6	
	225 mm (B) X 305 mm (L)		ATX
OS-Unterstützung	Windows XP / Vista 32 / Vista 64		Biostar behält sich das Recht vor, ohne Ankündigung die Unterstützung für ein Betriebssystem hinzuzufügen oder zu entfernen.

FRENCH

SPEC		
UC	Socket AM2+ / AM3 Processeurs AMD Athlon 64 / Athlon 64 FX / Athlon 64 X2 / Sempron / Phenom / Phenom II	L'architecture AMD 64 permet le calcul 32 et 64 bits Prend en charge Hyper Transport 3.0 et PowerNow
Bus frontal	Prend en charge Hyper Transport 3.0 jusqu'à une bande passante de 5.2 GT/s	
Chipset	AMD 790GX AMD SB750	
Super E/S	ITE 8718 Fournit la fonctionnalité de Super E/S patrimoniales la plus utilisée. Interface à faible compte de broches	Initiatives de contrôle environnementales, Moniteur de matériel Contrôleur de vitesse de ventilateur Fonction "Gardien intelligent" de l'ITE
Mémoire principale	Fentes DDR2 DIMM x 4 Capacité mémoire maximale de 16 Go Chaque DIMM prend en charge des DDR2 de 256Mo/512Mo/1Go/2Go/4Go	Module de mémoire DDR2 à mode à double voie Prend en charge la DDR2 533 / 667 / 800 Prend en charge la DDR2 1066 (by AM2+ / AM3 CPU) Les DIMM à registres et DIMM avec code correcteurs d'erreurs ne sont pas prises en charge
Graphiques	Radeon HD 3300	Onboard side port memory 128MB DDR2 Mémoire vidéo partagée maximale de 512 Mo Prise en charge DX10/UVD/HDCP Prise en charge (Hybrid) CrossFireX (by ATI driver)
IDE	AMD SB750	Mode principale de Bus Ultra DMA 33 / 66 / 100 / 133 Prend en charge le mode PIO 0~4,
SATA II	AMD SB750	Taux de transfert jusqu'à 3 Go/s. Conforme à la spécification SATA Version 2.0 Prise en charge RAID 0,1,5,1+0
LAN	Realtek RTL 8111DL	10 / 100 / 1000 Mb/s négociation automatique Half / Full duplex capability
Codec audio	ALC888	Sortie audio à 7.1 voies Prise en charge de l'audio haute définition
Fentes	Fente PCI x2 Fente PCI Express Gen2 x16 x2 Fente PCI Express Gen2 x1 x2	

<i>SPEC</i>			
Connecteur embarqué	Connecteur de disquette	x1	Chaque connector prend en charge 2 lecteurs de disquettes
	Connecteur de Port d'imprimante	x1	Chaque connector prend en charge 1 Port d'imprimante
	Connecteur IDE	x1	Chaque connecteur prend en charge 2 périphériques IDE
	Connecteur SATA	x6	Chaque connecteur prend en charge 1 périphérique SATA
	Connecteur du panneau avant	x1	Prend en charge les équipements du panneau avant
	Connecteur Audio du panneau avant	x1	Prend en charge la fonction audio du panneau avant
	Connecteur d'entrée CD	x1	Prend en charge la fonction d'entrée audio de CD
	Connecteur de sortie S/PDIF	x1	Prend en charge la fonction de sortie audio numérique
	Embase de ventilateur UC	x1	Alimentation électrique du ventilateur UC (avec fonction de ventilateur intelligent)
	Embase de ventilateur système	x2	Alimentation électrique du ventilateur système
	Embase d'effacement CMOS	x1	
	Connecteur USB	x3	Chaque connecteur prend en charge 2 ports USB de panneau avant
	Connecteur d'alimentation (24 broches)	x1	
Connecteur d'alimentation (4 broches)	x2		
E/S du panneau arrière	Clavier PS/2	x1	
	Souris PS/2	x1	
	Port HDMI	x1	
	Port VGA	x1	
	Port DVI-D	x1	
	Port LAN	x1	
	Port USB	x4	
Fiche audio	x6		
Dimensions de la carte	225 mm (l) X 305 mm (H)	ATX	
Support SE	Windows XP / Vista 32 / Vista 64		Biostar se réserve le droit d'ajouter ou de supprimer le support de SE avec ou sans préavis.

ITALIAN

SPECIFICA		
CPU	Socket AM2+ / AM3 Processori AMD Athlon 64 / Athlon 64 FX / Athlon 64 X2 / Sempron / Phenom / Phenom II	L'architettura AMD 64 abilita la computazione 32 e 64 bit Supporto di Hyper Transport 3.0 e PowerNow
FSB	Supporto di HyperTransport 3.0 fino a 5.2 GT/s di larghezza di banda	
Chipset	AMD 790GX AMD SB750	
Super I/O	ITE 8718 Fornisce le funzionalità legacy Super I/O usate più comunemente. Interfaccia LPC (Low Pin Count)	Funzioni di controllo dell'ambiente: Monitoraggio hardware Controller velocità ventolina Funzione "Smart Guardian" di ITE
Memoria principale	Alloggi DIMM DDR2 x 4 Capacità massima della memoria 16GB Ciascun DIMM supporta DDR2 256MB/512MB/1GB/2GB/4GB	Modulo di memoria DDR2 a canale doppio Supporto di DDR2 533 / 667 / 800 Supporto di DDR2 1066 (by AM2+ / AM3 CPU) DIMM registrati e DIMM ECC non sono supportati
Grafica	Radeon HD 3300	Onboard side port memory 128MB DDR2 La memoria video condivisa massima è di 512 MB Supporto DX10/UVD/HDCP Supporto (Hybrid) CrossFireX (by ATI driver)
IDE	AMD SB750	Modalità Bus Master Ultra DMA 33 / 66 / 100 / 133 Supporto modalità PIO Mode 0-4
SATA II	AMD SB750	Velocità di trasferimento dei dati fino a 3 Gb/s. Compatibile specifiche SATA Versione 2.0. Supporto RAID 0,1,5,1+0
LAN	Realtek RTL 8111DL	Negoziatura automatica 10 / 100 / 1000 Mb/s Capacità Half / Full Duplex
Codec audio	ALC888	Uscita audio 7.1 canali Supporto audio High-Definition (HD)
Alloggi	Alloggio PCI x2 Alloggio PCI Express Gen2 x16 x2 Alloggio PCI Express Gen2 x1 x2	

SPECIFICA			
Connettori su scheda	Connettore floppy	x1	Ciascun connettore supporta 2 unità Floppy
	Connettore Porta stampante	x1	Ciascun connettore supporta 1 Porta stampante
	Connettore IDE	x1	Ciascun connettore supporta 2 unità IDE
	Connettore SATA	x6	Ciascun connettore supporta 1 unità SATA
	Connettore pannello frontale	x1	Supporta i servizi del pannello frontale
	Connettore audio frontale	x1	Supporta la funzione audio pannello frontale
	Connettore CD-in	x1	Supporta la funzione input audio CD
	Connettore output S/PDIF	x1	Supporta la funzione d'output audio digitale
	Collettore ventolina CPU	x1	Alimentazione ventolina CPU (con funzione Smart Fan)
	Collettore ventolina sistema	x2	Alimentazione ventolina di sistema
	Collettore cancellazione CMOS	x1	
I/O pannello posteriore	Connettore USB	x3	Ciascun connettore supporta 2 porte USB pannello frontale
	Connettore alimentazione (24 pin)	x1	
	Connettore alimentazione (4 pin)	x2	
	Tastiera PS/2	x1	
	Mouse PS/2	x1	
I/O pannello posteriore	Porta HDMI	x1	
	Porta VGA	x1	
	Porta DVI-D	x1	
	Porta LAN	x1	
	Porta USB	x4	
	Connettore audio	x6	
Dimensioni scheda	225 mm (larghezza) x 305 mm (altezza)		ATX
Sistemi operativi supportati	Windows XP / Vista 32 / Vista 64		Biostar si riserva il diritto di aggiungere o rimuovere il supporto di qualsiasi sistema operativo senza preavviso.

SPANISH

<i>Especificación</i>		
CPU	Conector AM2+ / AM3 Procesadores AMD Athlon 64 / Athlon 64 FX / Athlon 64 X2 / Sempron / Phenom / Phenom II	La arquitectura AMD 64 permite el procesado de 32 y 64 bits Soporta las tecnologías Hyper Transport 3.0 y PowerNow
FSB	Admite HyperTransport 3.0 con un ancho de banda de hasta 5.2 GT/s	
Conjunto de chips	AMD 790GX AMD SB750	
Súper E/S	ITE 8718 Le ofrece las funcionalidades heredadas de uso más común Súper E/S. Interfaz de cuenta Low Pin	Iniciativas de control de entorno, Monitor hardware Controlador de velocidad de ventilador Función "Guardia inteligente" de ITE
Memoria principal	Ranuras DIMM DDR2 x 4 Capacidad máxima de memoria de 16GB Cada DIMM admite DDR de 256MB/512MB/1GB/2GB/4GB	Módulo de memoria DDR2 de canal Doble Admite DDR2 de 533 / 667 / 800 Admite DDR2 de 1066 (by AM2+ / AM3 CPU) No admite DIMM registrados o DIMM compatibles con ECC
Gráficos	Radeon HD 3300	Onboard side port memory 128MB DDR2 Memoria máxima de vídeo compartida de 512 MB Admite DX10/UVD/HDPCP Admite (Hybrid) CrossFireX (by ATI driver)
IDE	AMD SB750	Modo bus maestro Ultra DMA 33 / 66 / 100 / 133 Soporte los Modos PIO 0~4,
SATA II	AMD SB750	Tasas de transferencia de hasta 3 Gb/s. Compatible con la versión SATA 2.0. Admite RAID 0,1,5,1+0
Red Local	Realtek RTL 8111DL	Negociación de 10 / 100 / 1000 Mb/s Funciones Half / Full dúplex
Códecs de sonido	ALC888	Salida de sonido de 7.1 canales Soporte de sonido de Alta Definición
Ranuras	Ranura PCI X2 Ranura PCI Express Gen2 x16 X2 Ranura PCI express Gen2 x1 X2	

Especificación			
Conectores en placa	Conector disco flexible	X1	Cada conector soporta 2 unidades de disco flexible
	Conector Puerto de impresora	X1	Cada conector soporta 1 Puerto de impresora
	Conector IDE	X1	Cada conector soporta 2 dispositivos IDE
	Conector SATA	X6	Cada conector soporta 1 dispositivos SATA
	Conector de panel frontal	X1	Soporta instalaciones en el panel frontal
	Conector de sonido frontal	X1	Soporta funciones de sonido en el panel frontal
	Conector de entrada de CD	X1	Soporta función de entrada de sonido de CD
	Conector de salida S/PDIF	X1	Soporta función de salida de sonido digital
	Cabecera de ventilador de CPU	X1	Fuente de alimentación de ventilador de CPU (con función Smart Fan)
	Cabecera de ventilador de sistema	X2	Fuente de alimentación de ventilador de sistema
	Cabecera de borrado de CMOS	X1	
	Conector USB	X3	Cada conector soporta 2 puertos USB frontales
	Conector de alimentación (24 patillas)	X1	
	Conector de alimentación (4 patillas)	X2	
Panel trasero de E/S	Teclado PS/2	X1	
	Ratón PS/2	X1	
	Puerto HDMI	X1	
	Puerto VGA	X1	
	Puerto DVI-D	X1	
	Puerto de red local	X1	
	Puerto USB	X4	
	Conector de sonido	X6	
Tamaño de la placa	225 mm. (A) X 305 mm. (H)	ATX	
Soporte de sistema operativo	Windows XP / Vista 32 / Vista 64		Biostar se reserva el derecho de añadir o retirar el soporte de cualquier SO con o sin aviso previo.

PORTUGUESE

ESPECIFICAÇÕES		
CPU	Socket AM2+ / AM3 Processadores AMD Athlon 64 / Athlon 64 FX / Athlon 64 X2 / Sempron / Phenom / Phenom II	A arquitetura AMD 64 permite uma computação de 32 e 64 bits Suporta as tecnologias Hyper Transport 3.0 e PowerNow
FSB	Suporta a tecnologia HyperTransport 3.0 com uma largura de banda até 5.2 GT/s	
Chipset	AMD 790GX AMD SB750	
Especificação do Super I/O	ITE 8718 Proporciona as funcionalidades mais utilizadas em termos da especificação Super I/O. Interface LPC (Low Pin Count).	Iniciativas para controlo do ambiente Monitorização do hardware Controlador da velocidade da ventoinha Função "Smart Guardian" da ITE
Memória principal	Ranuras DIMM DDR2 x 4 Capacidade máxima de memória: 16 GB Cada módulo DIMM suporta uma memória DDR2 de 256MB/512MB/1GB/2GB/4GB	Módulo de memória DDR2 de canal duplo Suporta módulos DDR2 533 / 667 / 800 Suporta módulos DDR2 1066 (by AM2+ / AM3 CPU) Os módulos DIMM registados e os DIMM ECC não são suportados
Placa gráfica	Radeon HD 3300	Onboard side port memory 128MB DDR2 Memória de vídeo máxima partilhada: 512 MB Suporta as funções DX10/UVD/HDCP Suporta as funções (Hybrid) CrossFireX (by ATI driver)
IDE	AMD SB750	Modo Bus master Ultra DMA 33 / 66 / 100 / 133 Suporta o modo PIO 0~4,
SATA II	AMD SB750	Velocidades de transmissão de dados até 3 Gb/s. Compatibilidade com a especificação SATA versão 2.0. Suporta as funções RAID 0,1,5,1+0
LAN	Realtek RTL 8111DL	Auto negociação de 10 / 100 / 1000 Mb/s Capacidade semi/full-duplex
Codec de som	ALC888	Saída de áudio de 7.1 canais Suporta a especificação High-Definition Audio
Ranuras	Ranhura PCI x2 Ranhura PCI Express Gen2 x16 x2 Ranhura PCI Express Gen2 x1 x2	

ESPECIFICAÇÕES			
Conectores na placa	Conector da unidade de disquetes	x1	Cada conector suporta 2 unidades de disquetes
	Conector da para impressora	x1	Cada conector suporta 1 Porta para impressora
	Conector IDE	x1	Cada conector suporta 2 dispositivos IDE
	Conector SATA	x6	Cada conector suporta 1 dispositivo SATA
	Conector do painel frontal	x1	Para suporte de várias funções no painel frontal
	Conector de áudio frontal	x1	Suporta a função de áudio no painel frontal
	Conector para entrada de CDs	x1	Suporta a entrada de áudio a partir de CDs
	Conector de saída S/PDIF	x1	Suporta a saída de áudio digital
	Conector da ventoinha da CPU	x1	Alimentação da ventoinha da CPU (com a função Smart Fan)
	Conector da ventoinha do sistema	x2	Alimentação da ventoinha do sistema
	Conector para limpeza do CMOS	x1	
	Conector USB	x3	Cada conector suporta 2 portas USB no painel frontal
	Conector de alimentação (24 pinos)	x1	
Conector de alimentação (4 pinos)	x2		
Entradas/Saídas no painel traseiro	Teclado PS/2	x1	
	Rato PS/2	x1	
	Porta HDMI	x1	
	Porta VGA	x1	
	Porta DVI-D	x1	
	Porta LAN	x1	
	Porta USB	x4	
Tomada de áudio	x6		
Tamanho da placa	225 mm (L) X 305 mm (A)	ATX	
Sistemas operativos suportados	Windows XP / Vista 32 / Vista 64		A Biostar reserva-se o direito de adicionar ou remover suporte para qualquer sistema operativo com ou sem aviso prévio.

POLISH

<i>SPEC</i>		
Procesor	Socket AM2+ / AM3 AMD Athlon 64 / Athlon 64 FX / Athlon 64 X2 / Sempron / Phenom / Phenom II Procesory	Architektura AMD 64 umożliwia przetwarzanie 32 i 64 bitowe Obsługa Hyper Transport 3.0 oraz PowerNow
FSB	Obsługa HyperTransport 3.0 o szerokości pasma do 5.2 GT/s	
Chipset	AMD 790GX AMD SB750	
Pamięć główna	Gniazda DDR2 DIMM x 4 Maks. wielkość pamięci 16GB Każde gniazdo DIMM obsługuje moduły 256MB/512MB/1GB/2GB/4GB DDR2	Moduł pamięci DDR2 z trybem podwójnego kanału Obsługa DDR2 533 / 667 / 800 Obsługa DDR2 1066 (by AM2+ / AM3 CPU) Brak obsługi Registered DIMM oraz ECC DIMM
Grafika	Radeon HD 3300	Onboard sideport memory 128MB DDR2 Maks. wielkość współdzielonej pamięci video wynosi 512 MB Obsługa DX10/UVD/HDCP Obsługa (Hybrid) CrossFireX (by ATI driver)
Super I/O	ITE 8718 Zapewnia najbardziej powszechne funkcje Super I/O. Interfejs Low Pin Count	Funkcje kontroli warunków pracy, Monitor H/W Kontroler prędkości wentylatora Funkcja ITE "Smart Guardian"
IDE	AMD SB750	Ultra DMA 33 / 66 / 100 / 133 Tryb Bus Master obsługa PIO tryb 0~4,
SATA II	AMD SB750	Transfer danych do 3 Gb/s. Zgodność ze specyfikacją SATA w wersji 2.0. Obsługa RAID 0,1,5,1+0
LAN	Realtek RTL 8111DL	10 / 100 / 1000 Mb/s z automatyczną negocjacją szybkości Działanie w trybie półwicznego/pełnego duplexu
Kodek dźwiękowy	ALC888	7.1 kanałowe wyjście audio Obsługa High-Definition Audio
Gniazda	Gniazdo PCI x2 Gniazdo PCI Express Gen2 x16 x2 Gniazdo PCI Express Gen2 x1 x2	

SPEC			
Złącza wbudowane	Złącze napędu dyskietek	x1	Każde złącze obsługuje 2 napędy dyskietek
	Złącze Port drukarki	x1	Każde złącze obsługuje 1 Port drukarki
	Złącze IDE	x1	Każde złącze obsługuje 2 urządzenia IDE
	Złącze SATA	x6	Każde złącze obsługuje 1 urządzenie SATA
	Złącze panela przedniego	x1	Obsługa elementów panela przedniego
	Przednie złącze audio	x1	Obsługa funkcji audio na panelu przednim
	Złącze wejścia CD	x1	Obsługa funkcji wejścia audio CD
	Złącze wyjścia S/PDIF	x1	Obsługa funkcji cyfrowego wyjścia audio
	Złącze główkowe wentylatora procesora	x1	Zasilanie wentylatora procesora (z funkcją Smart Fan)
	Złącze główkowe wentylatora systemowego	x2	Zasilanie wentylatora systemowego
	Złącze główkowe kasowania CMOS	x1	
	Złącze USB	x3	Każde złącze obsługuje 2 porty USB na panelu przednim
Złącze zasilania (24 pinowe)	x1		
Złącze zasilania (4 pinowe)	x2		
Back Panel I/O	Klawiatura PS/2	x1	
	Mysz PS/2	x1	
	Port HDMI	x1	
	Port VGA	x1	
	Port DVI-D	x1	
	Port LAN	x1	
	Port USB	x4	
Gniazdo audio	x6		
Wymiary płyty	225 mm (S) X 305 mm (W)	ATX	
Obsługa systemu operacyjnego	Windows XP / Vista 32 / Vista 64		Biostar zastrzega sobie prawo dodawania lub odwoływania obsługi dowolnego systemu operacyjnego bez powiadomienia.

RUSSIAN

СПЕЦ		
CPU (центральный процессор)	Гнездо AM2+ / AM3 Процессоры AMD Athlon 64 / Athlon 64 FX / Athlon 64 X2 / Sempron / Phenom / Phenom II	Архитектура AMD 64 разрешать обработка данных на 32 и 64 бит Поддержка Hyper Transport 3.0 и PowerNow
FSB	Поддержка HyperTransport 3.0 с пропускной способностью до 5.2 GT/s	
Набор микросхем	AMD 790GX AMD SB750	
Основная память	Слоты DDR2 DIMM x 4 Максимальная ёмкость памяти 16 ГБ Каждый модуль DIMM поддерживает 256МБ/512МБ/1ГБ/2ГБ/4ГБ DDR2	Модуль памяти с двухканальным режимом DDR2 Поддержка DDR2 533 / 667 / 800 Поддержка DDR2 1066 (by AM2+ / AM3 CPU) Не поддерживает зарегистрированные модули DIMM and ECC DIMM
Графика	Radeon HD 3300	Onboard side port memory 128MB DDR2 Максимальная совместно используемая видео память составляет 512 МБ Поддержка DX10/UVD/HDCP Поддержка (Hybrid) CrossFireX (by ATI driver)
Super I/O	ITE 8718 Обеспечивает наиболее используемые действующие функциональные возможности Super I/O. Интерфейс с низким количеством выводов	Инициативы по охране окружающей среды, Аппаратный монитор Регулятор скорости Функция ITE "Smart Guardian" (Интеллектуальная защита)
IDE	AMD SB750	Режим "хозяина" шины Ultra DMA 33 / 66 / 100 / 133 Поддержка режима PIO 0~4,
SATA II	AMD SB750	скорость передачи данных до 3 гигабит/с. Соответствие спецификации SATA версия 2.0. Поддержка RAID 0,1,5,1+0
Локальная сеть	Realtek RTL 8111DL	Автоматическое согласование 10 / 100 / 1000 Мб/с Частичная / полная дуплексная способность
Звуковой кодек	ALC888	Звуковая поддержка High-Definition 7.1канальный звуковой выход
Слоты	Слот PCI x2 Слот PCI Express Gen2 x16 x2 Слот PCI Express Gen2 x1 x2	

СПЕЦ			
Встроенны й разъем	Разъем НГМД	x1	Каждый разъем поддерживает 2 накопителя на гибких магнитных дисках
	Разъем Порт подключения принтера	x1	Каждый разъем поддерживает 1 Порт подключения принтера
	Разъем IDE	x1	Каждый разъем поддерживает 2 встроенных интерфейса накопителей
	Разъем SATA	x6	Каждый разъем поддерживает 1 устройство SATA
	Разъем на лицевой панели	x1	Поддержка устройств на лицевой панели
	Входной звуковой разъем	x1	Поддержка звуковых функций на лицевой панели
	Разъем ввода для CD	x1	Поддержка функции ввода для CD
	Разъем вывода для S/PDIF	x1	Поддержка вывода цифровой звуковой функции
	Контактирующее приспособление вентилятора центрального процессора	x1	Источник питания для вентилятора центрального процессора (с функцией интеллектуального вентилятора)
	Контактирующее приспособление вентилятора системы	x2	Источник питания для вентилятора системы
	Открытое контактирующее приспособление CMOS	x1	
	USB-разъем	x3	Каждый разъем поддерживает 2 USB-порта на лицевой панели
	Разъем питания (24 вывод)	x1	
Разъем питания (4 вывод)	x2		
Задняя панель средств ввода-выв ода	Клавиатура PS/2	x1	
	Мышь PS/2	x1	
	Порт HDMI	x1	
	Порт VGA	x1	
	Порт DVI-D	x1	
	Порт LAN	x1	
	USB-порт	x4	
Гнездо для подключения наушников	x6		
Размер панели	225 мм (Ш) X 305 мм (В)	ATX	
Поддержка OS	Windows XP / Vista 32 / Vista 64		Biostar сохраняет за собой право добавлять или удалять средства обеспечения для OS с или без предварительного уведомления.

ARABIC

المواصفات		
وحدة المعالجة المركزية	AM2+ / AM3 مقبس AMD Athlon 64 / Athlon 64 FX / Sempron / Phenom / Phenom II / Athlon 64 X2 معالجات	إجراء العمليات الحاسوبية بسرعة 32 و 64 بت AMD 64 يمكن تقنية PowerNow و Hyper Transport 3.0 تدعم تقنية
النقل الأمامي الجانبي	5.2 GT/s بتردد يصل إلى 3.0 HyperTransport تدعم تقنية	
مجموعة الشرائح	AMD 790GX AMD SB750	
الذاكرة الرئيسية	قناة DDR2 DIMM عدد 4 سعة ذاكرة قصوى 16 جيجا بايت ميغا 256/512 سعة DDR2 تدعم ذاكرة من نوع DIMM تدعم كل قناة بايت و 1/2 و 4 جيجا بايت	مزودة القاعة DDR2 وحدة ذاكرة سعت 800 / 667 / 533 ميجا بايت DDR2 تدعم الذاكرة من نوع سعت 1066 ميجا بايت DDR2 تدعم الذاكرة من نوع (DDR2 1066 is by AM2+ / AM3 CPU) ECC وتلك التي لا تتوافق مع DIMM لا تدعم رقائق الذاكرة
بطاقة الرسومات	Radeon HD 3300	Onboard side port memory 128MB DDR2 ميجا بايت 512 أقصى سعة لذاكرة الفيديو المشتركة HDCP/UVD/DX10 تدعم تقنية CrossFireX (Hybrid) تدعم تقنية (by ATI driver)
Super I/O	ITE 8718 الأكثر استخداماً Super I/O يوفر وظيفة Low Pin Court Interface تدعم تقنية	وسائل التحكم في البيئة: مراقب لمعرفة حالة الأجهزة مراقب في سرعة المروحة ITE من "Smart Guardian" وظيفة
منفذ IDE	AMD SB750	Ultra DMA 33 / 66 / 100 / 133 نقل تقنية وضع رئيسي PIO Mode 0~4 لدعم وضع
SATA II	AMD SB750	نقل البيانات بسرعة تصل إلى 3 جيجابت/ثانية. 2.0 الإصدار SATA مطابقة للمواصفات RAID 0,1,5,1+0 تدعم تقنية
شبكة داخلية	Realtek RTL 8111DL	تفاوض تلقائي 100/10 ميجا بايت / ثمانية و 1 جيجا بت/ثانية إمكانية النقل المزدوج الكامل/القصفي
كوديك الصوت	ALC888	تدعم تقنية الصوت عالي التعريف من 7.1 قنوات لخرج الصوت

TA790GXE 128M

للمواصفات			
	عدد 2	قطة PCI	القحاح
	عدد 2	قطة PCI Express Gen2 x 16	
	عدد 2	قطة PCI Express Gen2 x 1	
يدعم محركين للأقراص المرنة	عدد 1	منفذ محرك أقراص مرنة	المنافذ على سطح اللوحة
	عدد 1	منفذ طباعة	
يدعم كل منفذ اثنين من أجهزة IDE	عدد 1	منفذ IDE	
يدعم كل منفذ واحد من أجهزة SATA	عدد 6	منفذ SATA	
يدعم تجهيزات اللوحة الأمامية	عدد 1	منفذ اللوحة الأمامية	
يدعم وظيفة الصوت باللوحة الأمامية	عدد 1	منفذ الصوت الأمامي	
يدعم وظيفة دخل صوت القرص المدمج	عدد 1	منفذ CD-IN	
يدعم وظيفة خرج الصوت الرقمي	عدد 1	منفذ خرج S/PDIF	
Smart Fan توصل الطاقة لمروحة وحدة المعالجة مع وظيفة	عدد 1	وصلة مروحة وحدة المعالجة المركزية	
توصل الطاقة لمروحة النظام	عدد 2	وصلة مروحة النظام	
	عدد 1	وصلة مسح CMOS	
باللوحة الأمامية USB يدعم كل منفذ قحني	عدد 3	منفذ USB	
	عدد 1	منفذ توصيل الطاقة (24بيوس)	
	عدد 2	منفذ توصيل الطاقة (4بيبيس)	
	عدد 1	لوحة مفاتيح PS/2	
	عدد 1	ملوس PS/2	
	عدد 1	منافذ HDMI	
	عدد 1	منافذ VGA	
	عدد 1	منافذ DVI-D	
	عدد 1	منفذ شبكة اتصال محلية	
	عدد 4	منافذ USB	
	عدد 6	مقيس صوت	
ATX	225 مم (عرض) X 305 مم (ارتفاع)		حجم اللوحة
بحقها في اإضافة أو إزالة الدعم لأي نظام تشغيل بإخطار أو Biostar تحتفظ بدون إخطار.	Windows XP / Vista 32 / Vista 64		دعم أنظمة التشغيل

JAPANESE

仕様		
CPU	Socket AM2+ / AM3 AMD Athlon 64 / Athlon 64 FX / Athlon 64 X2 / Sempron / Phenom / Phenom II プロセッサ	AMD 64アーキテクチャでは、32ビットと64ビット計算が可能です ハイパートランスポート3.0とクールアンドクワイアットをサポートします
FSB	5.2 GT/sのバンド幅までハイパートランスポート3.0をサポートします	
チップセット	AMD 790GX AMD SB750	
メインメモリ	DDR2 DIMMスロット x 4 最大メモリ容量16GB 各DIMMは 256MB/512MB/1GB/2GB/4GB DDR2をサポート	デュアル チャンネルモードDDR2メモリモジュール DDR2 533 / 667 / 800 をサポート DDR2 1066 をサポート (by AM2+ / AM3 CPU) 登録済みDIMMとECC DIMMはサポートされません
グラフィックス	Radeon HD 3300	Onboard side port memory 128MB DDR2 最大の共有ビデオメモリは512MBです DX10/UVD/HDCP のサポート (Hybrid) CrossFireX のサポート(by ATI driver)
Super I/O	ITE 8718 もつとも一般に使用されるレガシーSuper I/O機能を採用しています。 低ピンカウントインターフェイス	環境コントロールイニシアチブ、 H/Wモニター ファン速度コントローラ/ モニター ITEの「スマートガーディアン」機能
IDE	AMD SB750	Ultra DMA 33 / 66 / 100 / 133バスマスタモード PIO Mode 0~4のサポート、
SATA II	AMD SB750	最高3 Gb/秒のデータ転送速度 SATAバージョン2.0仕様に準拠。 RAID 0,1,5,1+0のサポート
LAN	Realtek RTL 8111DL	10 / 100 / 1000 Mb/秒のオートネゴシエーション 半/全二重機能
サウンド Codec	ALC888	ハイデフィニションオーディオのサポート 7.1 チャンネルオーディオアウト
スロット	PCIスロット x2 PCI Express Gen2 x16スロット x2 PCI Express Gen2 x1スロット x2	

TA790GXE 128M

仕様			
オンボードコネクタ	フロッピーコネクタ	x1	各コネクタは2つのフロッピードライブをサポートします
	プリンタポートコネクタ	x1	各コネクタは1つのプリンタポートをサポートします
	IDEコネクタ	x1	各コネクタは2つのIDEデバイスをサポートします
	SATAコネクタ	x6	各コネクタは1つのSATAデバイスをサポートします
	フロントパネルコネクタ	x1	フロントパネル機能をサポートします
	フロントオーディオコネクタ	x1	フロントパネルオーディオ機能をサポートします
	CDインコネクタ	x1	CDオーディオイン機能をサポートします
	S/PDIFアウトコネクタ	x1	デジタルオーディオアウト機能をサポートします
	CPUファンヘッダ	x1	CPUファン電源装置(スマートファン機能を搭載)
	システムファンヘッダ	x2	システムファン電源装置
	CMOSクリアヘッダ	x1	
	USBコネクタ	x3	各コネクタは2つのフロントパネルUSBポートをサポートします
	電源コネクタ(24ピン)	x1	
電源コネクタ(4ピン)	x2		
背面パネル I/O	PS/2キーボード	x1	
	PS/2マウス	x1	
	HDMIポート	x1	
	VGAポート	x1	
	DVI-Dポート	x1	
	LANポート	x1	
	USBポート	x4	
	オーディオジャック	x6	
ボードサイズ	225 mm (幅) X 305 mm (高さ)	ATX	
OSサポート	Windows XP / Vista 32 / Vista 64		Biostarは事前のサポートなしにOSサポートを追加または削除する権利を留保します。

2009/03/16