

====TA780GE/TA760GE/TA785GE/TA785GE 128M/TA790GXE====
Setup Manual

FCC Information and Copyright

This equipment has been tested and found to comply with the limits of a Class B digital device, pursuant to Part 15 of the FCC Rules. These limits are designed to provide reasonable protection against harmful interference in a residential installation. This equipment generates, uses, and can radiate radio frequency energy and, if not installed and used in accordance with the instructions, may cause harmful interference to radio communications. There is no guarantee that interference will not occur in a particular installation.

The vendor makes no representations or warranties with respect to the contents here and specially disclaims any implied warranties of merchantability or fitness for any purpose. Further the vendor reserves the right to revise this publication and to make changes to the contents here without obligation to notify any party beforehand.

Duplication of this publication, in part or in whole, is not allowed without first obtaining the vendor's approval in writing.

The content of this user's manual is subject to be changed without notice and we will not be responsible for any mistakes found in this user's manual. All the brand and product names are trademarks of their respective companies.

Table of Contents

Chapter 1: Introduction	1
1.1 Before You Start	1
1.2 Package Checklist	1
1.3 Motherboard Features	2
1.4 Rear Panel Connectors	3
1.5 Motherboard Layout	4
Chapter 2: Hardware Installation	5
2.1 Installing Central Processing Unit (CPU)	5
2.2 FAN Headers	7
2.3 Installing System Memory	8
2.4 Connectors and Slots	10
Chapter 3: Headers & Jumpers Setup	13
3.1 How to Setup Jumpers	13
3.2 Detail Settings	13
Chapter 4: Hybrid CrossFireX Function	18
4.1 Hybrid CrossFireX Requirements	19
4.2 Hybrid CrossFireX Installation	19
Chapter 5: RAID Functions	20
5.1 Operating System	20
5.2 Raid Arrays	20
5.3 How RAID Works	20
Chapter 6: T-Series BIOS & Software	24
6.1 T-Series BIOS	24
6.2 T-Series Software	32
Chapter 7: Useful Help	42
7.1 Driver Installation Note	42
7.2 Extra Information	43
7.3 AMI BIOS Beep Code	44
7.4 Troubleshooting	45
Appendix: SPEC In Other Languages	46
German	46
French	48
Italian	50
Spanish	52
Portuguese	54
Polish	56
Russian	58
Arabic	60
Japanese	62

CHAPTER 1: INTRODUCTION

1.1 BEFORE YOU START

Thank you for choosing our product. Before you start installing the motherboard, please make sure you follow the instructions below:

- Prepare a dry and stable working environment with sufficient lighting.
- Always disconnect the computer from power outlet before operation.
- Before you take the motherboard out from anti-static bag, ground yourself properly by touching any safely grounded appliance, or use grounded wrist strap to remove the static charge.
- Avoid touching the components on motherboard or the rear side of the board unless necessary. Hold the board on the edge, do not try to bend or flex the board.
- Do not leave any unfastened small parts inside the case after installation. Loose parts will cause short circuits which may damage the equipment.
- Keep the computer from dangerous area, such as heat source, humid air and water
- The operating temperatures of the computer should be 0 to 45 degrees Celsius.

1.2 PACKAGE CHECKLIST

- ✚ IDE Cable X 1 (optional)
- ✚ Serial ATA Cable X 3
- ✚ Serial ATA Power Cable X 1
- ✚ Rear I/O Panel for ATX Case X 1
- ✚ User's Manual X 1
- ✚ Fully Setup Driver CD X 1
- ✚ FDD Cable X 1 (optional)
- ✚ USB 2.0 Cable X1 (optional)
- ✚ S/PDIF out Cable X 1 (optional)
- ✚ DVI to HDMI Dongle X 1 (optional)

Note: The package contents may be different due to area or your motherboard version.

1.3 MOTHERBOARD FEATURES

	TA780GE/TA760GE/ TA785GE/TA785GE 128M	TA790GXE
CPU	Socket AM2+ AMD Athlon 64 / Athlon 64 FX / Athlon 64 X2 / Sempron / Phenom / Phenom II processors AMD 64 Architecture enables 32 and 64 bit computing Supports Hyper Transport 3.0	Socket AM2+ AMD Athlon 64 / Athlon 64 FX / Athlon 64 X2 / Sempron / Phenom / Phenom II processors AMD 64 Architecture enables 32 and 64 bit computing Supports Hyper Transport 3.0
FSB	Support HyperTransport 3.0 Supports up to 5.2 GT/s Bandwidth Supports up to 4.4 GT/s Bandwidth (TA785GE/TA785GE 128M)	Support HyperTransport 3.0 Supports up to 5.2 GT/s Bandwidth
Chipset	AMD 780G (TA780GE) AMD 760G (TA760GE) AMD 785G (TA785GE/TA785GE 128M) AMD SB710	AMD 790GX AMD SB750
Super I/O	ITE IT8718F Provides the most commonly used legacy Super I/O functionality. Low Pin Count Interface Environment Control initiatives, H/W Monitor Fan Speed Controller ITE's "Smart Guardian" function	ITE IT8718F Provides the most commonly used legacy Super I/O functionality. Low Pin Count Interface Environment Control initiatives, H/W Monitor Fan Speed Controller ITE's "Smart Guardian" function
Main Memory	DIMM Slots x 4 Each DIMM supports 256MB/512MB/1GB/2GB/4GB DDR2 Max Memory Capacity 16GB Dual Channel Mode DDR2 memory module Supports DDR2 533 / 667 / 800 Supports DDR2 1066 (by AM2+/AM3 CPU) Registered DIMM and ECC DIMM is not supported	DIMM Slots x 4 Each DIMM supports 256MB/512MB/1GB/2GB/4GB DDR2 Max Memory Capacity 16GB Dual Channel Mode DDR2 memory module Supports DDR2 533 / 667 / 800 Supports DDR2 1066 (by AM2+/AM3 CPU) Registered DIMM and ECC DIMM is not supported
Graphics	780G (HD3200)/760G (HD3000)/785G(HD4200) Onboard side port memory 128MB DDR2 (TA785GE 128M Only) Max Shared Video Memory is 512MB DX10/DVIsupport Hybrid CrossFireX support (by ATI driver)	790GX (HD3300) Onboard side port memory 128MB DDR2 Max Shared Video Memory is 512MB DX10/DVIsupport Hybrid CrossFireX support (by ATI driver)
IDE	AMD SB710 Ultra DMA 33 / 66 / 100 / 133 Bus Master Mode supports PIO Mode 0~4,	AMD SB750 Ultra DMA 33 / 66 / 100 / 133 Bus Master Mode supports PIO Mode 0~4,
SATA II	AMD SB710 Data transfer rates up to 3 Gb/s. SATA Version 2.0 specification compliant. RAID 0,1,1+0 support	AMD SB750 Data transfer rates up to 3 Gb/s. SATA Version 2.0 specification compliant. RAID 0,1,5,1+0 support

TA780GE/TA760GE/TA785GE/TA785GE 128M/TA790GXE

	TA780GE/TA760GE/ TA785GE/TA785GE 128M		TA790GXE
LAN	Realtek RTL 8111DL 10 / 100 Mb/s / 1Gb/s auto negotiation Half / Full duplex capability		Realtek RTL 8111DL 10 / 100 Mb/s / 1Gb/s auto negotiation Half / Full duplex capability
Sound	ALC662 5.1channels audio out Supports HD Audio		ALC662 5.1channels audio out Supports HD Audio
Slots	PCI slot	x2	PCI slot
	PCI Express Gen2 x16 slot	x1	PCI Express Gen2 x16 slot
On Board Connectors	Floppy Connector	x1	Floppy Connector
	IDE Connector	x1	IDE Connector
	SATA Connector	x6	SATA Connector
	Front Panel Connector	x1	Front Panel Connector
	Front Audio Connector	x1	Front Audio Connector
	CD-in Connector	x1	CD-in Connector
	S/PDIF out Connector	x1	S/PDIF out Connector
	CPU Fan Header	x1	CPU Fan Header
	System Fan Header	x2	System Fan Header
	CMOS clear Header	x1	CMOS clear Header
	USB Connector	x3	USB Connector
	Serial Port Connector	x1	Serial Port Connector
	Power Connector (24pin)	x1	Power Connector (24pin)
	Power Connector (4pin)	x1	Power Connector (4pin)
Back Panel I/O	PS/2 Keyboard	x1	PS/2 Keyboard
	PS/2 Mouse	x1	PS/2 Mouse
	VGA port	x1	VGA port
	DVI-D port	x1	DVI-D port
	LAN port	x1	LAN port
	USB Port	x4	USB Port
	Audio Jack	x3	Audio Jack
Board Size	233 mm (W) x 244 mm (L)		233 mm (W) x 244 mm (L)
OS Support	Windows XP / Vista / 7 Biostar reserves the right to add or remove support for any OS With or without notice.		Windows XP / Vista / 7 Biostar reserves the right to add or remove support for any OS With or without notice.

1.4 REAR PANEL CONNECTORS

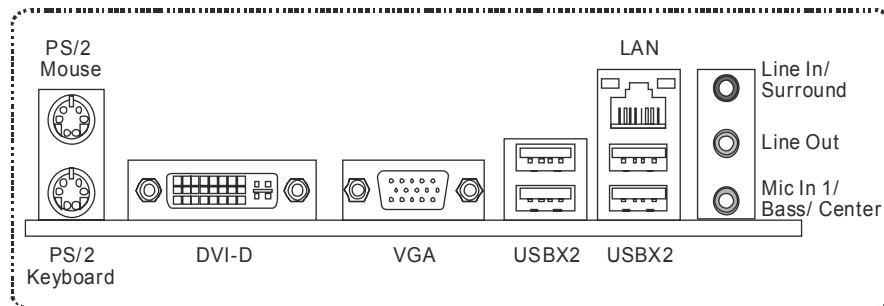

1.5 MOTHERBOARD LAYOUT

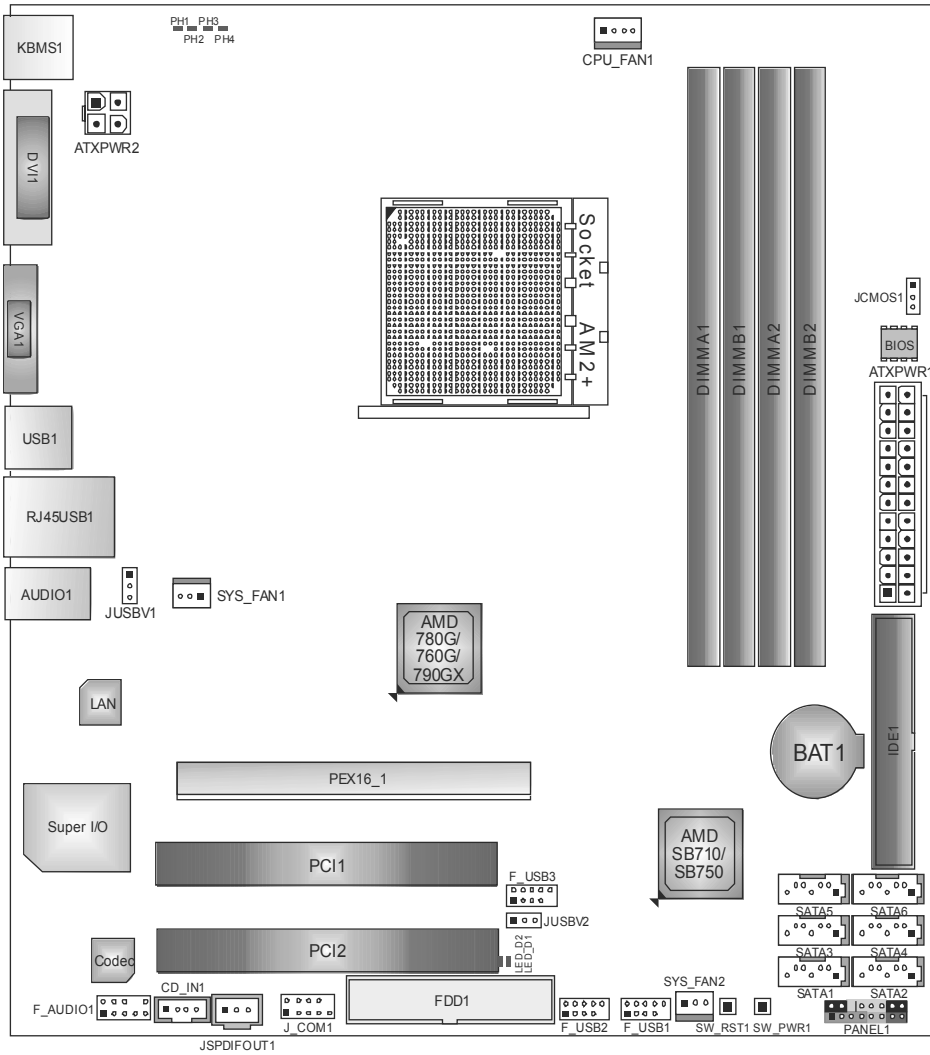

Note: ■ represents the 1st pin.

CHAPTER 2: HARDWARE INSTALLATION

2.1 INSTALLING CENTRAL PROCESSING UNIT (CPU)

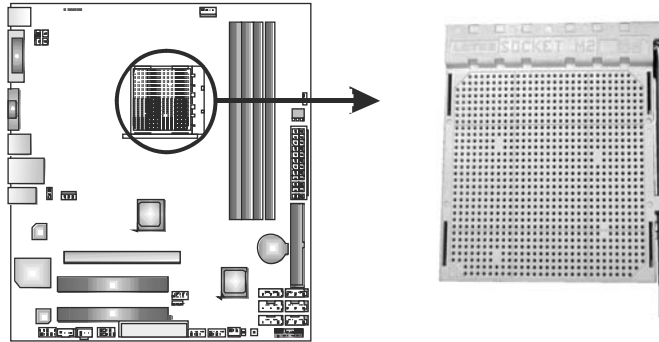

Step 1: Pull the lever toward direction A from the socket and then raise the lever up to a 90-degree angle.

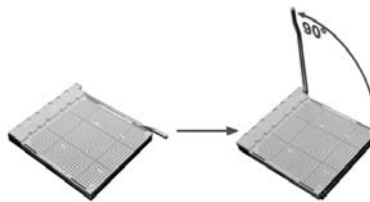

Step 2: Look for the white triangle on socket, and the gold triangle on CPU should point towards this white triangle. The CPU will fit only in the correct orientation.



Step 3: Hold the CPU down firmly, and then close the lever toward direct B to complete the installation.

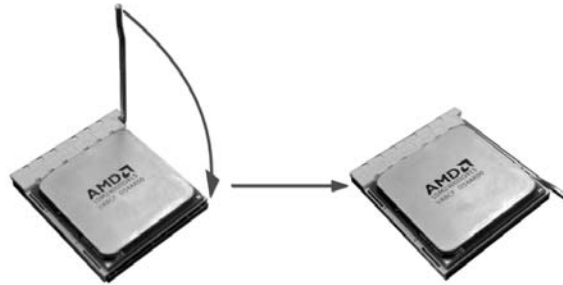

Step 4: Put the CPU Fan on the CPU and buckle it. Connect the CPU FAN power cable to CPU_FAN1 to complete the installation.

Note: Please update the BIOS to the latest version while using AM2+/AM3 CPUs. Due to the latest CPU transition, you may encounter the situation that the new system failed to boot while using new AM2+/AM3 CPUs. In this case, please install one standard AM2 CPU to boot your system, and update the latest BIOS from our website for AM2+/AM3 CPUs support.

2.2 FAN HEADERS

These fan headers support cooling-fans built in the computer. The fan cable and connector may be different according to the fan manufacturer. Connect the fan cable to the connector while matching the black wire to pin#1.

CPU_FAN1: CPU Fan Header

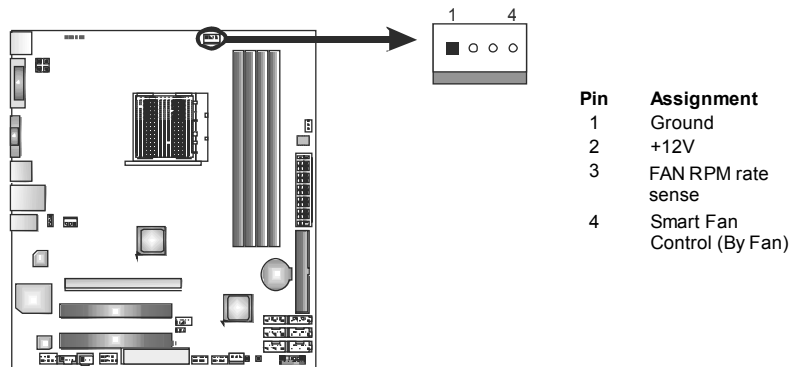

SYS_FAN1: NorthBridge Fan Header

SYS_FAN2: System Fan Header

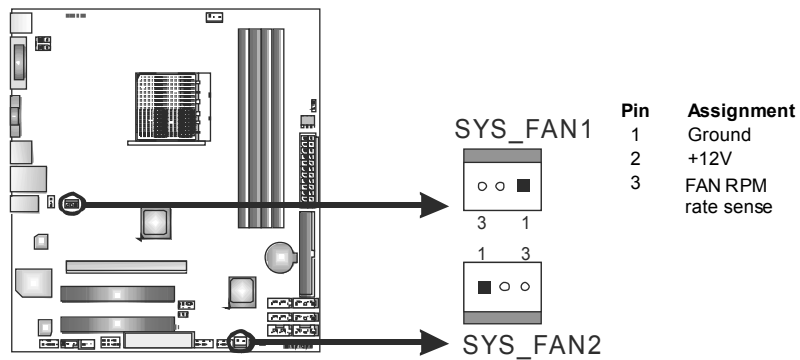

Note:

CPU_FAN1, SYS_FAN1/2 support 4-pin and 3-pin head connectors. When connecting with wires onto connectors, please note that the red wire is the positive and should be connected to pin#2, and the black wire is Ground and should be connected to GND.

2.3 INSTALLING SYSTEM MEMORY

A. DDR2 Modules

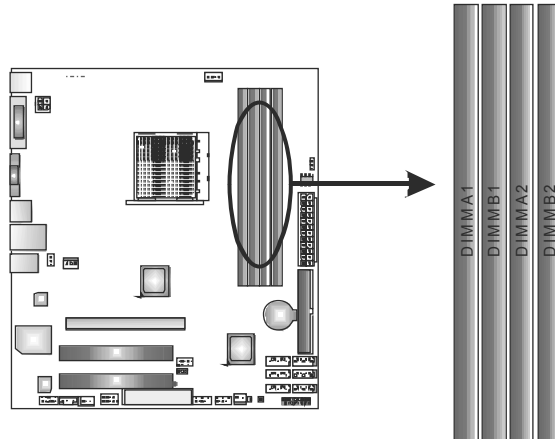

1. Unlock a DIMM slot by pressing the retaining clips outward. Align a DIMM on the slot such that the notch on the DIMM matches the break on the Slot.

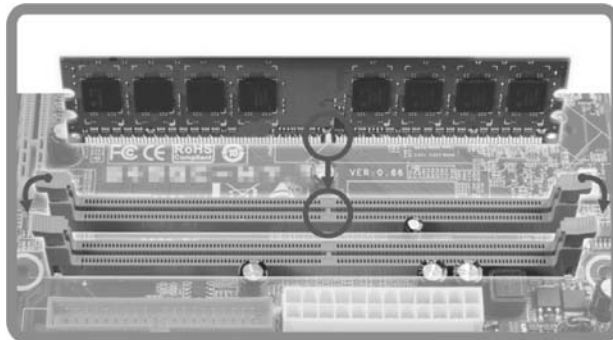

2. Insert the DIMM vertically and firmly into the slot until the retaining chip snap back in place and the DIMM is properly seated.

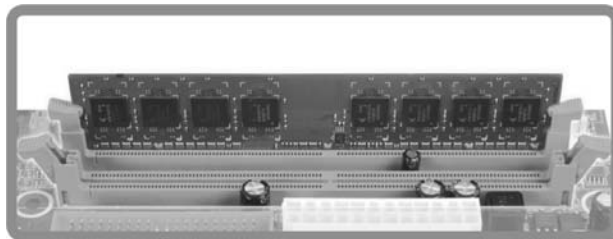

B. Memory Capacity

DIMM Socket Location	DDR2 Module	Total Memory Size
DIMMA1	256MB/512MB/1GB/2GB/4GB	Max is 16GB.
DIMMB1	256MB/512MB/1GB/2GB/4GB	
DIMMA2	256MB/512MB/1GB/2GB/4GB	
DIMMB2	256MB/512MB/1GB/2GB/4GB	

C. Dual Channel Memory installation

Please refer to the following requirements to activate Dual Channel function:

Install memory module of the same density in pairs, shown in the table.

Dual Channel Status	DIMMA1	DIMMB1	DIMMA2	DIMMB2
Enabled	O	O	X	X
Enabled	X	X	O	O
Enabled	O	O	O	O

(O means memory installed, X means memory not installed.)

The DRAM bus width of the memory module must be the same (x8 or x16)

2.4 CONNECTORS AND SLOTS

FDD1: Floppy Disk Connector

The motherboard provides a standard floppy disk connector that supports 360K, 720K, 1.2M, 1.44M and 2.88M floppy disk types.

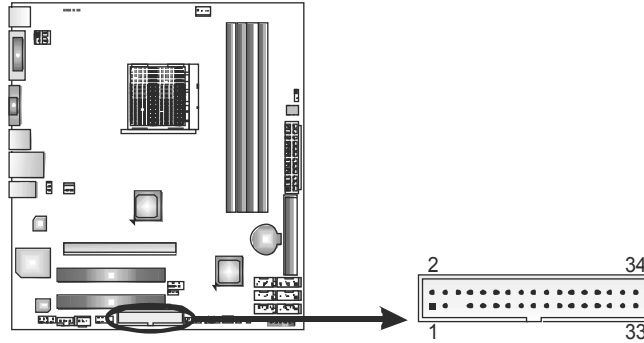

IDE1: IDE/ATAPI Connector

The motherboard has a 32-bit Enhanced IDE Controller that provides PIO Mode 0~4, Bus Master, and Ultra DMA 33/66/100/133 functionality.

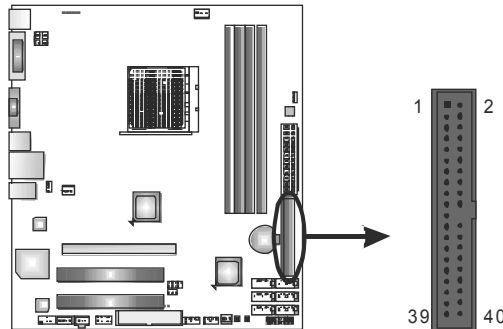

SATA1~SATA6: Serial ATA Connectors

The motherboard has a PCI to SATA Controller with 6 channels SATA interface, it satisfies the SATA 2.0 spec and with transfer rate of 3.0Gb/s.

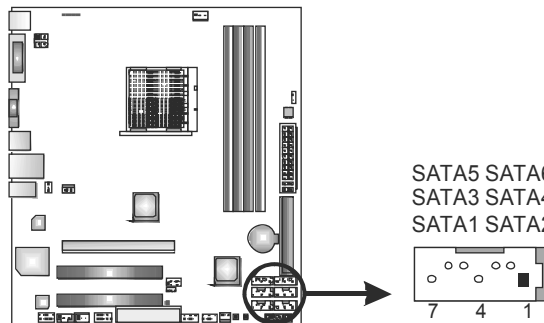

Pin	Assignment
1	Ground
2	TX+
3	TX-
4	Ground
5	RX-
6	RX+
7	Ground

ATXPWR1: ATX Power Source Connector

This connector allows user to connect 24-pin power connector on the ATX power supply.

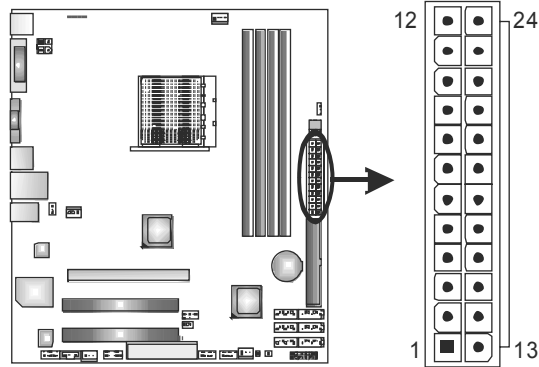

Pin	Assignment	Pin	Assignment
13	+3.3V	1	+3.3V
14	-12V	2	+3.3V
15	Ground	3	Ground
16	PS_ON	4	+5V
17	Ground	5	Ground
18	Ground	6	+5V
19	Ground	7	Ground
20	NC	8	PW_OK
21	+5V	9	Standby Voltage+5V
22	+5V	10	+12V
23	+5V	11	+12V
24	Ground	12	+3.3V

ATXPWR2: ATX Power Source Connector

Connecting this connector will provide +12V to CPU power circuit.

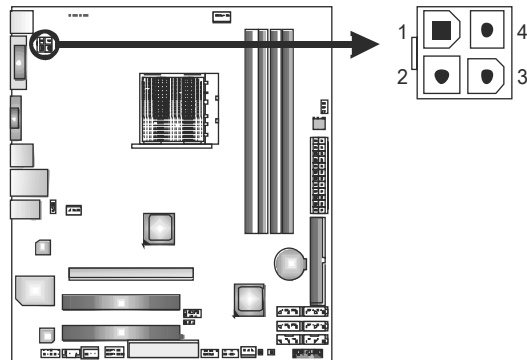

Pin	Assignment
1	+12V
2	+12V
3	Ground
4	Ground

Note:

Before power on the system, please make sure that both ATXPWR1 and ATXPWR2 connectors have been plugged-in.

PEX16_1: PCI-Express Gen2 x16 Slot

- PCI-Express 2.0 compliant.
- Maximum theoretical realized bandwidth of 8GB/s simultaneously per direction, for an aggregate of 16GB/s totally.
- PCI-Express Gen2 supports a raw bit-rate of 5.0Gb/s on the data pins.
- 2X bandwidth over the PCI-Express 1.1 architecture.

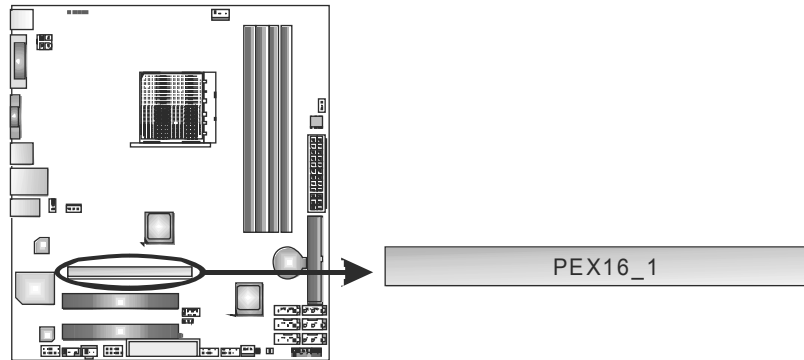

PCI1/PCI2: Peripheral Component Interconnect Slots

This motherboard is equipped with 2 standard PCI slots. PCI stands for Peripheral Component Interconnect, and it is a bus standard for expansion cards. This PCI slot is designated as 32 bits.

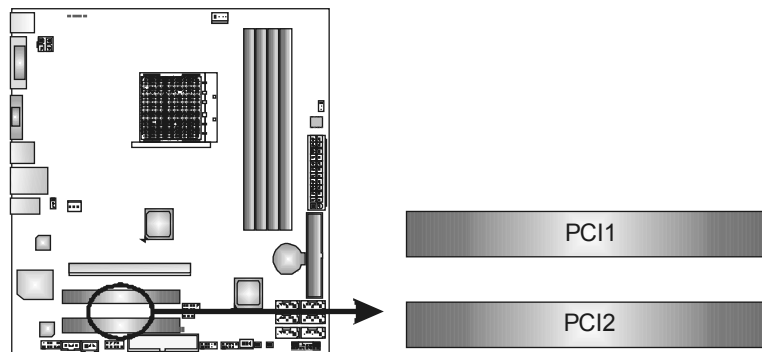

CHAPTER 3: HEADERS & JUMPERS SETUP

3.1 HOW TO SETUP JUMPERS

The illustration shows how to set up jumpers. When the jumper cap is placed on pins, the jumper is “close”, if not, that means the jumper is “open”.

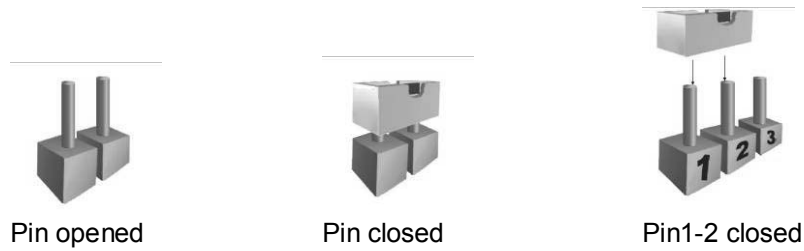

3.2 DETAIL SETTINGS

PANEL1: Front Panel Header

This 16-pin connector includes Power-on, Reset, HDD LED, Power LED, and speaker connection. It allows user to connect the PC case’s front panel switch functions.

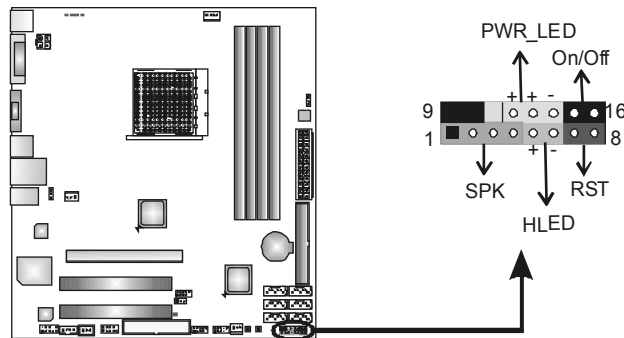

Pin	Assignment	Function	Pin	Assignment	Function
1	+5V	Speaker Connector	9	N/A	N/A
2	N/A		10	N/A	
3	N/A		11	N/A	
4	Speaker	Hard drive LED	12	Power LED (+)	Power LED
5	HDD LED (+)		13	Power LED (+)	
6	HDD LED (-)	Reset button	14	Power LED (-)	
7	Ground		15	Power button	
8	Reset control		16	Ground	

JCMOS1: Clear CMOS Header

Placing the jumper on pin2-3 allows user to restore the BIOS safe setting and the CMOS data. Please carefully follow the procedures to avoid damaging the motherboard.

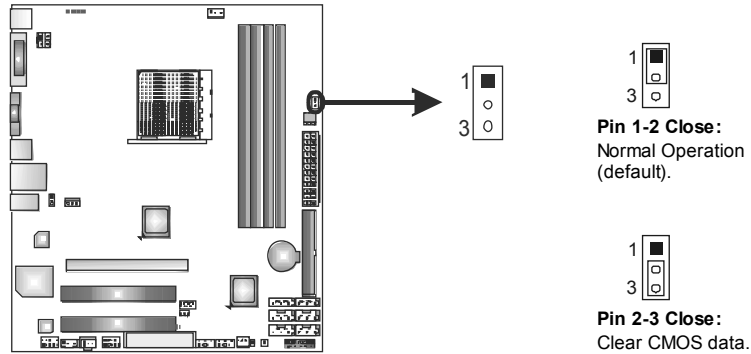

※ Clear CMOS Procedures:

1. Remove AC power line.
2. Set the jumper to “Pin 2-3 close”.
3. Wait for five seconds.
4. Set the jumper to “Pin 1-2 close”.
5. Power on the AC.
6. Reset your desired password or clear the CMOS data.

F_USB1~F_USB3: Headers for USB 2.0 Ports at Front Panel

These headers allow user to connect additional USB cable on the PC front panel, and also can be connected with internal USB devices, like USB card reader.

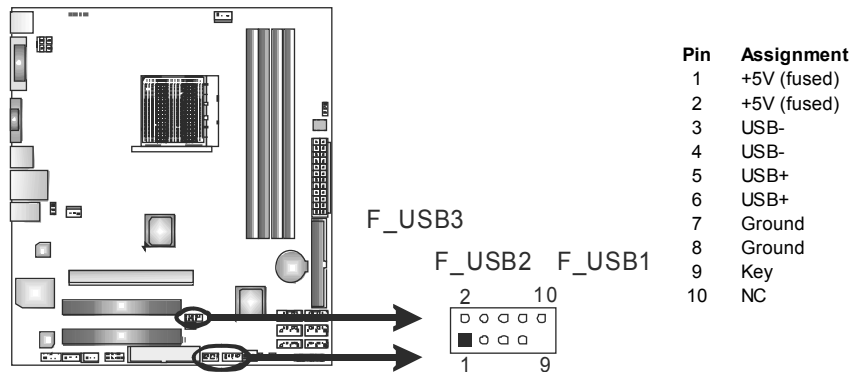

F_AUDIO1: Front Panel Audio Header

This header allows user to connect the front audio output cable with the PC front panel. This header allows only HD audio front panel connector; AC'97 connector is not acceptable.

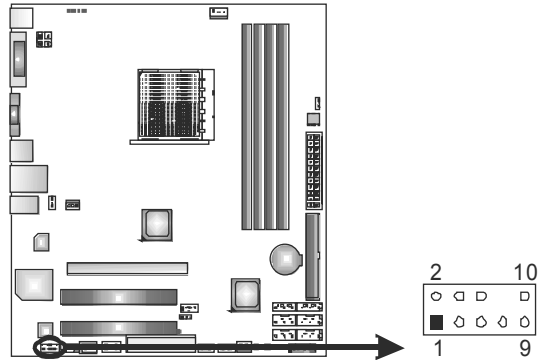

Pin	Assignment
1	Mic Left in
2	Ground
3	Mic Right in
4	GPIO
5	Right line in
6	Jack Sense
7	Front Sense
8	Key
9	Left line in
10	Jack Sense

JSPDIFOUT1: Digital Audio-out Connector

This connector allows user to connect the PCI bracket SPDIF output header.

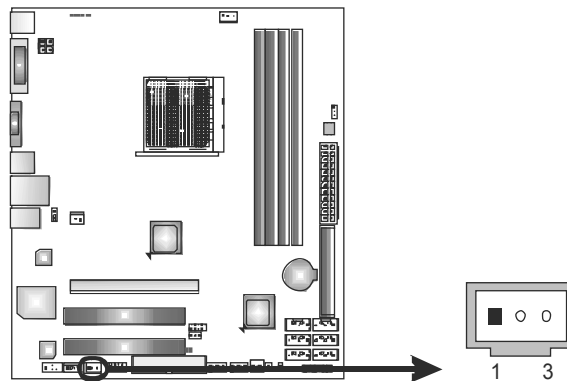

Pin	Assignment
1	+5V
2	SPDIF_OUT
3	Ground

CD_IN1: CD-ROM Audio-in Connector

This connector allows user to connect the audio source from the variety devices, like CD-ROM, DVD-ROM, PCI sound card, PCI TV turner card etc.

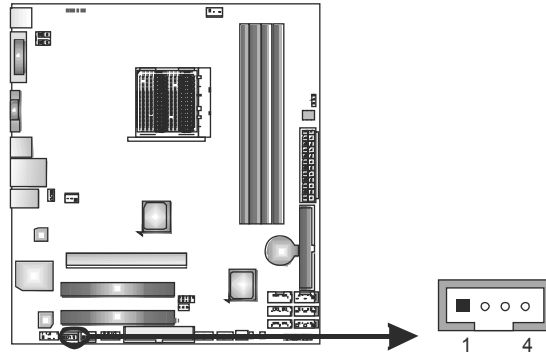

Pin	Assignment
1	Left Channel Input
2	Ground
3	Ground
4	Right Channel Input

JUSBV1/JUSBV2: Power Source Headers for USB Ports

Pin 1-2 Close:

JUSBV1: +5V for USB ports at USB1/RJ45USB1.

JUSBV2: +5V for USB ports at F_USB1/F_USB2/F_USB3.

Pin 2-3 Close:

JUSBV1: +5V STB for USB ports at USB1/RJ45USB1.

JUSBV2: +5V STB for USB ports at F_USB1/F_USB2/F_USB3.

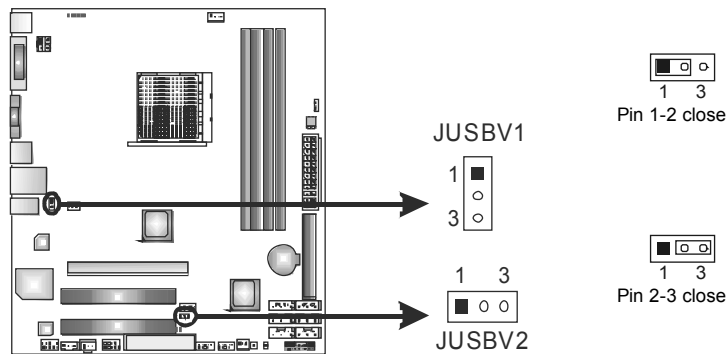

On-Board LED Indicators

There are 6 LED indicators showing system status.

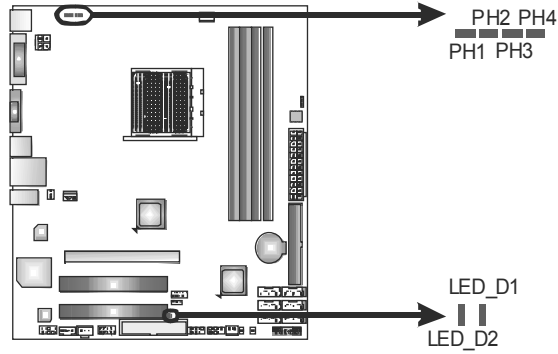

LED_D1 & LED_D2: Debug Indicators

PH1 ~ PH4: Power Status Indicators

Please refer to the tables below for specific messages:

LED_D1	LED_D2	Message
ON	ON	Normal
ON	OFF	Memory Error
OFF	ON	VGA Error
OFF	OFF	Abnormal: CPU / Chipset error.

PH1~PH4	Phase Indicator
ON	Phase Active
OFF	Phase Disable

On-Board Buttons

There are 2 on-board buttons.

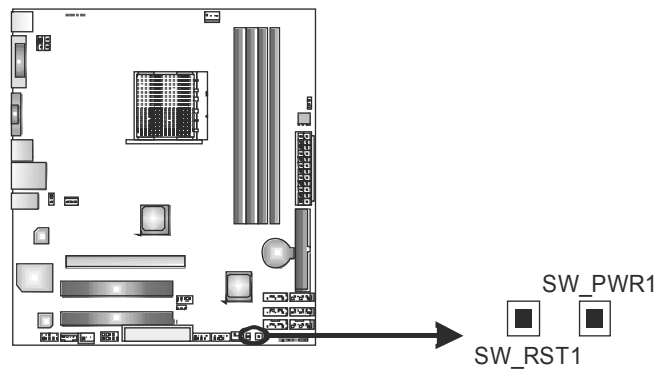

SW_RST1: Reset button.

SW_PWR1: Power Switch button.

J_COM1: Serial port Connector

The motherboard has a Serial Port Connector for connecting RS-232 Port.

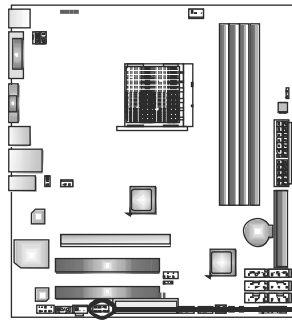

Pin	Assignment
1	Carrier detect
2	Received data
3	Transmitted data
4	Data terminal ready
5	Signal ground
6	Data set ready
7	Request to send
8	Clear to send
9	Ring indicator
10	NC

CHAPTER 4: HYBRID CROSSFIREX FUNCTION

4.1 HYBRID CROSSFIREX REQUIREMENTS

- Only **Windows Vista** supports Hybrid CrossFireX function.
- A graphics card with **Radeon HD3450/HD3470** GPU.
- The graphics card driver should support Hybrid CrossFireX technology.
- The power supply unit must provide at least the minimum power required by the system, or the system will be unstable. A power supply above 450W is recommended under Hybrid CrossFireX mode.

4.2 HYBRID CROSSFIREX INSTALLATION

Step 1: Insert the Hybrid CrossFireX-Ready graphics card into PEX16_1.

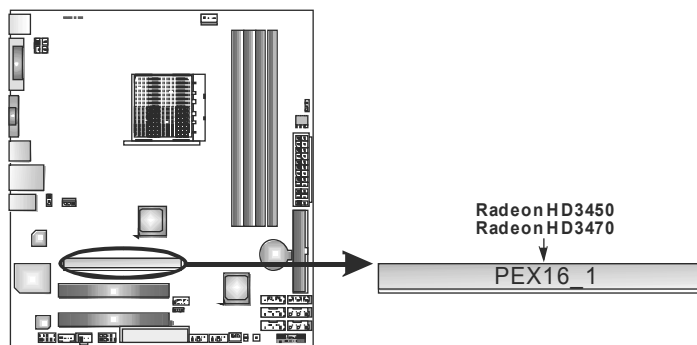

Notice: Make sure the graphics card is seated into slot completely.

Step 2: In the graphics card configuration program, choose “Hybrid CrossFireX” function. Installation completes.

NOTE

For more detail information of Hybrid CrossFireX function, please visit following web-sites:

http://game.amd.com/us-en/crossfirex_hybrid.aspx

<http://ati.amd.com/technology/hybridgraphics/index.html>

CHAPTER 5: RAID FUNCTIONS

5.1 OPERATING SYSTEM

Supports Windows XP and Windows VISTA.

5.2 RAID ARRAYS

RAID supports the following types of RAID arrays:

RAID 0: RAID 0 defines a disk striping scheme that improves disk read and write times for many applications.

RAID 1: RAID 1 defines techniques for mirroring data.

RAID 1+0: RAID 1+0 combines the techniques used in RAID 0 and RAID 1.

RAID 5: RAID 5 provides fault tolerance and better utilization of disk capacity.

5.3 How RAID WORKS

RAID 0:

The controller “stripes” data across multiple drives in a RAID 0 array system. It breaks up a large file into smaller blocks and performs disk reads and writes across multiple drives in parallel. The size of each block is determined by the stripe size parameter, which you set during the creation of the RAID set based on the system environment. This technique reduces overall disk access time and offers high bandwidth.

Features and Benefits

- **Drives:** Minimum 2, and maximum is up to 6 or 8. Depending on the platform.
- **Uses:** Intended for non-critical data requiring high data throughput, or any environment that does not require fault tolerance.
- **Benefits:** provides increased data throughput, especially for large files. No capacity loss penalty for parity.
- **Drawbacks:** Does not deliver any fault tolerance. If any drive in the array fails, all data is lost.
- **Fault Tolerance:** No.

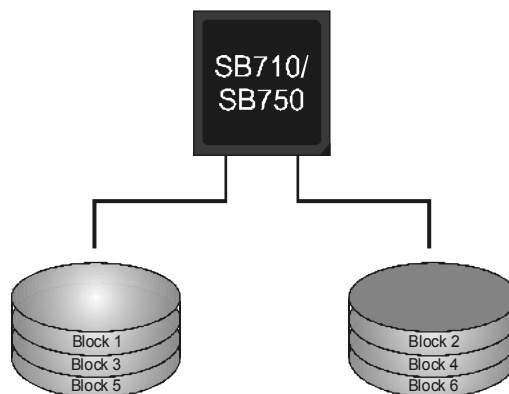

RAID 1:

Every read and write is actually carried out in parallel across 2 disk drives in a RAID 1 array system. The mirrored (backup) copy of the data can reside on the same disk or on a second redundant drive in the array. RAID 1 provides a hot-standby copy of data if the active volume or drive is corrupted or becomes unavailable because of a hardware failure. RAID techniques can be applied for high-availability solutions, or as a form of automatic backup that eliminates tedious manual backups to more expensive and less reliable media.

Features and Benefits

- **Drives:** Minimum 2, and maximum is 2.
- **Uses:** RAID 1 is ideal for small databases or any other application that requires fault tolerance and minimal capacity.
- **Benefits:** Provides 100% data redundancy. Should one drive fail, the controller switches to the other drive.
- **Drawbacks:** Requires 2 drives for the storage space of one drive. Performance is impaired during drive rebuilds.
- **Fault Tolerance:** Yes.

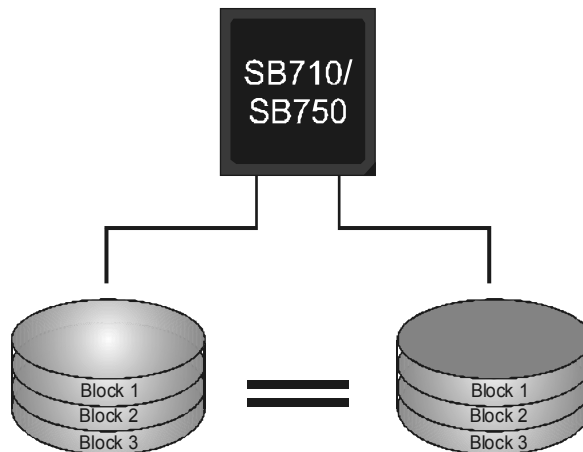

RAID 1+0:

RAID 1 drives can be striped using RAID 0 techniques. Resulting in a RAID 1+0 solution for improved resiliency, performance and rebuild performance.

Features and Benefits

- **Drives:** Minimum 4, and maximum is 6 or 8, depending on the platform.
- **Benefits:** Optimizes for both fault tolerance and performance, allowing for automatic redundancy. May be simultaneously used with other RAID levels in an array, and allows for spare disks.
- **Drawbacks:** Requires twice the available disk space for data redundancy, the same as RAID level 1.
- **Fault Tolerance:** Yes.

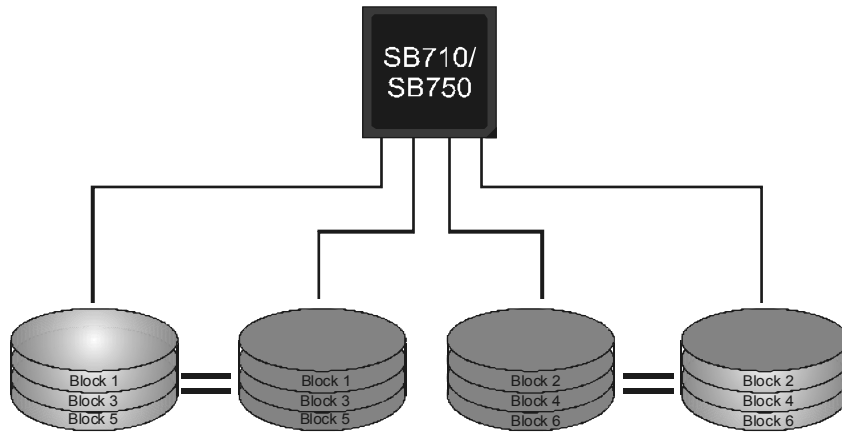

RAID 5: (TA790GXE Only)

RAID 5 stripes both data and parity information across three or more drives. It writes data and parity blocks across all the drives in the array. Fault tolerance is maintained by ensuring that the parity information for any given block of data is placed on a different drive from those used to store the data itself.

Features and Benefits

- **Drives:** Minimum 3.
- **Uses:** RAID 5 is recommended for transaction processing and general purpose service.
- **Benefits:** An ideal combination of good performance, good fault tolerance, and high capacity and storage efficiency.
- **Drawbacks:** Individual block data transfer rate same as a single disk. Write performance can be CPU intensive.
- **Fault Tolerance:** Yes.

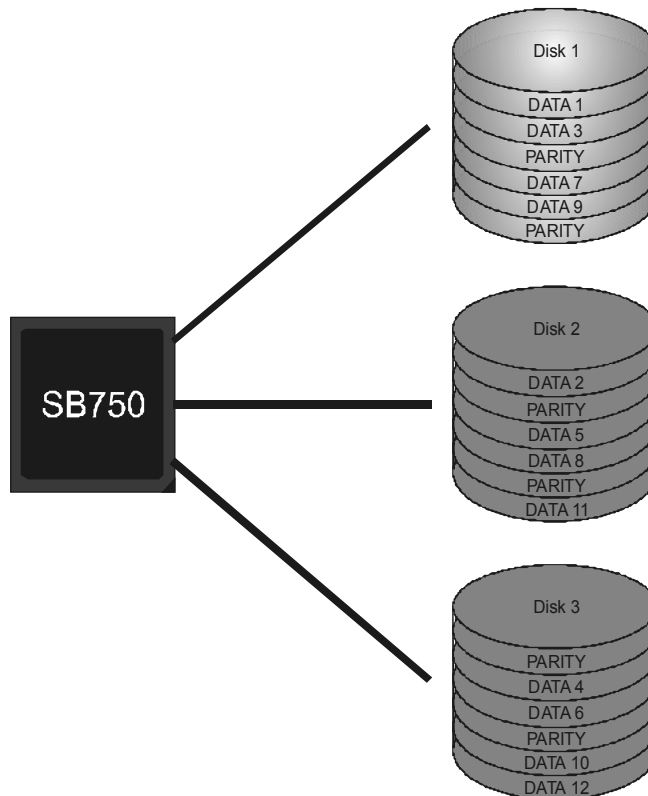

CHAPTER 6: T-SERIES BIOS & SOFTWARE

6.1 T-SERIES BIOS

T-Series BIOS Features

- Overclocking Navigator Engine (O.N.E.)
- Memory Integration Test (M.I.T., under Overclock Navigator Engine)
- BIO-Flasher: Update BIOS file from USB Flash Drive or FDD
- Self Recovery System (S.R.S)
- Smart Fan Function
- CMOS Reloading Program

!! WARNING !!

For better system performance, the BIOS firmware is being continuously updated. The BIOS information described below in this manual is for your reference only and the actual BIOS information and settings on board may be different from this manual. For further information of setting up the BIOS, please refer to the BIOS Manual in the Setup CD.

A. Overclocking Navigator Engine (O.N.E.)

ONE provides two powerful overclocking engines: MOS and AOS for both Elite and Casual overclockers.

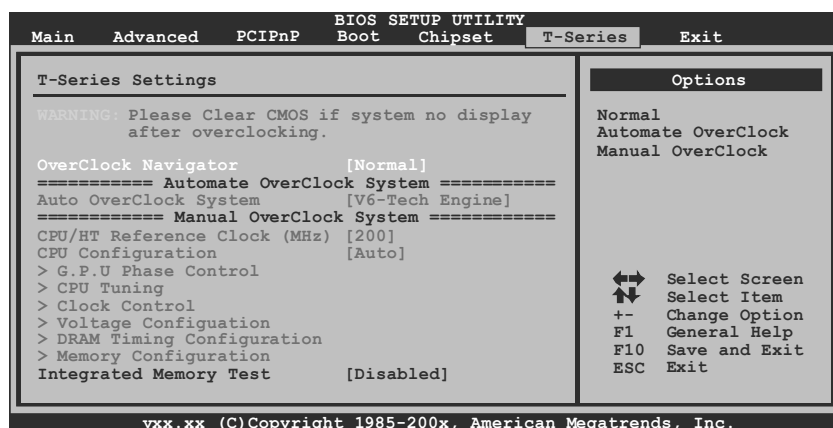

TA780GE/TA760GE/TA785GE/TA785GE 128M/TA790GXE Manual Overclock System (M.O.S.)

MOS is designed for experienced overclock users.
It allows users to customize personal overclock settings.

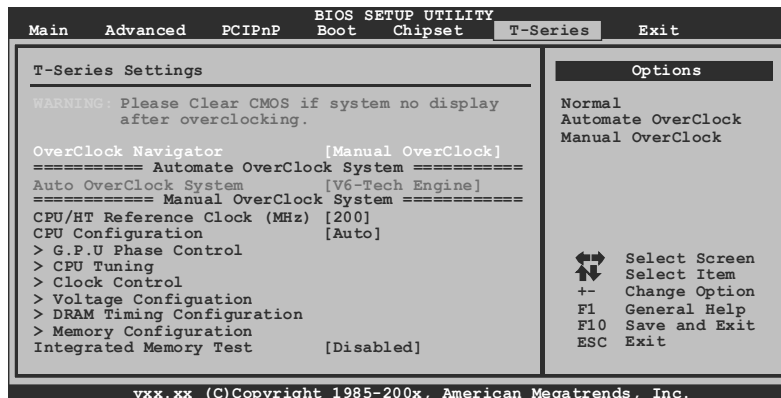
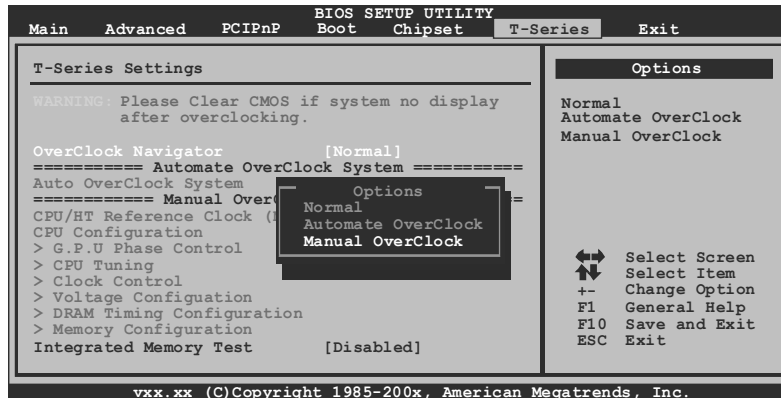

CPU/HT Reference Clock (MHz)

CPU Frequency is directly in proportion to system performance. To maintain the system stability, CPU voltage needs to be increased also when raising CPU frequency.

CPU Configuration

This item provides several fixed modes of CPU configuration.

G.P.U Phase Control

Enter this function for more power saving settings.

CPU Tuning

Enter this function for more advanced CPU settings.

Clock Control

Enter this function for more clock settings.

Voltage Configuration

Enter this function for more advanced voltage settings.

DRAM Timing Configuration

Enter this function for more advanced DRAM clock settings.

Memory Configuration

Enter this function for more advanced memory settings.

NOTE

Overclock is an optional process, but not a “must-do” process; it is not recommended for inexperienced users. Therefore, we will not be responsible for any hardware damage which may be caused by overclocking. We also would not guarantee any overclocking performance.

Automatic Overclock System (A.O.S.)

For beginners in overclock field, BET had developed an easy, fast, and powerful feature to increase the system performance, named A.O.S. Based on many tests and experiments, A.O.S. provides 3 ideal overclock configurations that are able to raise the system performance in a single step.

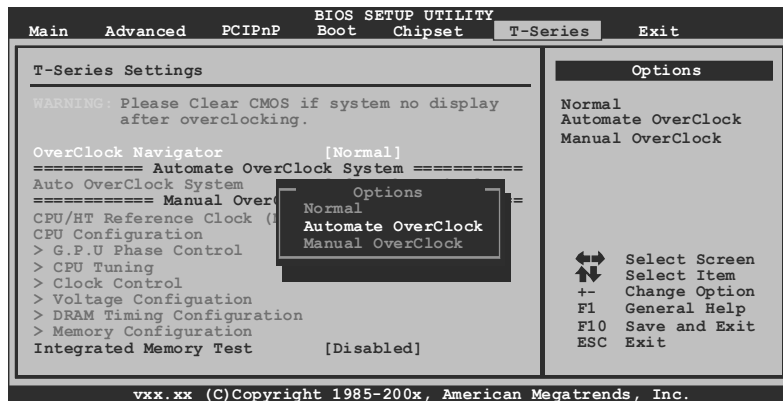

V6 Tech Engine

This engine will make a good over-clock performance.

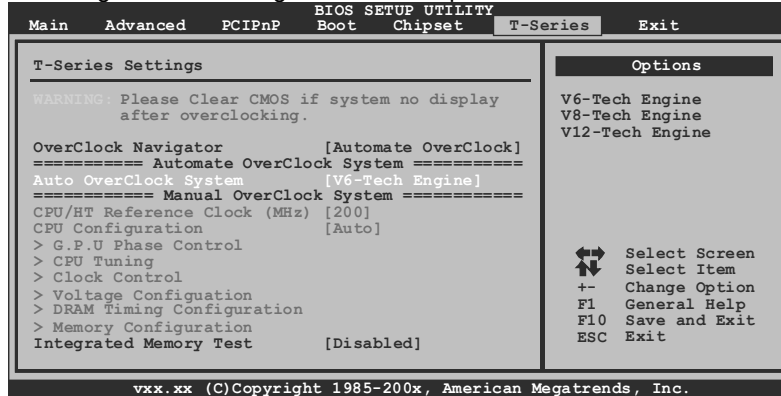

V8 Tech Engine

This engine will make a better over-clock performance.

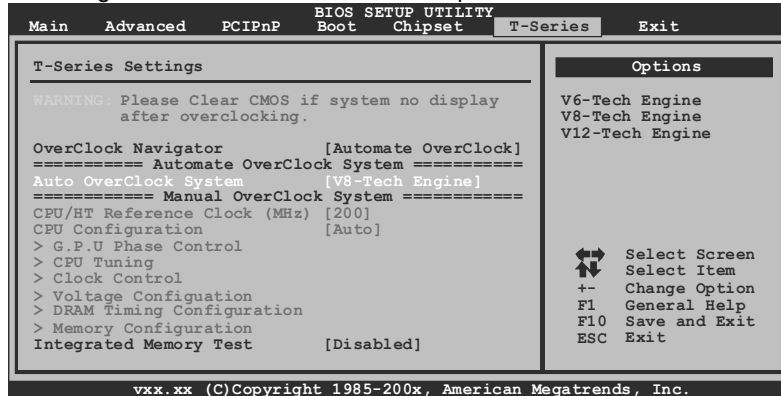

V12 Tech Engine

This engine will make a best over-clock performance.

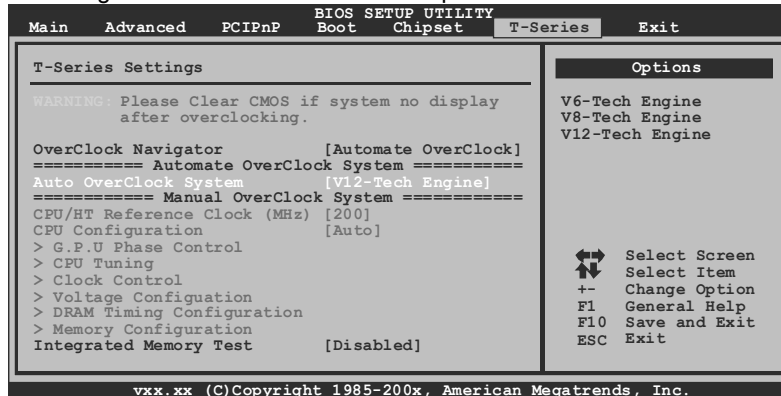

Notices:

Not all types of AMD CPU perform above overclock setting ideally; the difference will be based on the selected CPU model.

B. Memory Integration Test (M.I.T.)

This function is under “Overclocking Navigator Engine” item.

MIT allows users to test memory compatibilities, and no extra devices or software are needed.

Step 1

The default setting under this item is “Disabled”; the condition parameter should be changed to “Enable” to proceed this test.

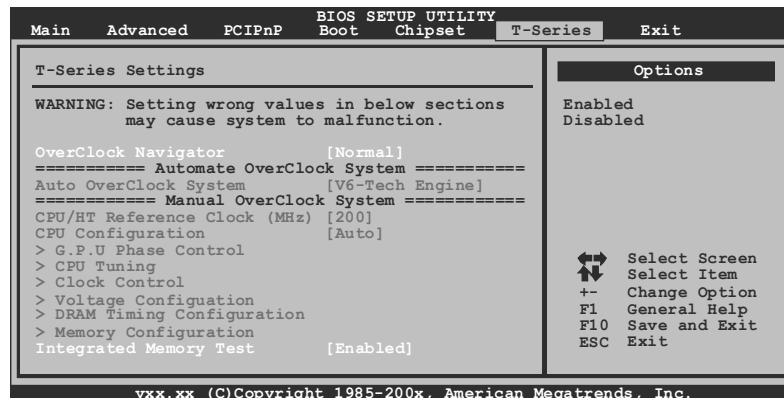
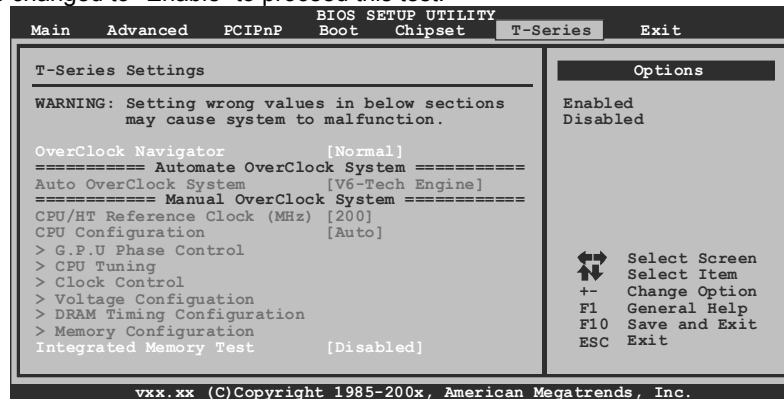

Step 2

Save and Exit from CMOS setup and reboot the system to activate this test.

Run this test for 5 minutes (minimum) to ensure the memory stability.

Step 3

When the process is done, change the setting back from “Enable” to “Disable” to complete the test.

C. BIO-Flasher

BIO-Flasher is a BIOS flashing utility providing you an easy and simple way to update your BIOS via USB pen drive or floppy disk.

The BIO-Flasher is built in the BIOS chip. To enter the utility, **press <F12> during the Power-On Self Tests (POST)** procedure while booting up.

Updating BIOS with BIO-Flasher

1. Go to the website to download the latest BIOS file for the motherboard.
2. Then, save the BIOS file into a USB pen drive or a floppy disk.
3. Insert the USB pen drive or the floppy disk that contains the BIOS file to the USB port or the floppy disk drive.
4. Power on or reset the computer and then press **<F12>** during the **POST** process. A select dialog as the picture on the right appears. Select the device contains the BIOS file and press **<Enter>** to enter the utility.



5. The utility will show the BIOS files and their respective information. Select the proper BIOS file and press **<Enter>** then **<Y>** to perform the BIOS update process.

6. After the update process, the utility will ask you to reboot the system. Press **<Y>** to proceed. BIOS update completes.



- This utility only allows storage device with FAT32/16 format and single partition.
- Shutting down or resetting the system while updating the BIOS will lead to system boot failure.

D. Self Recovery System (S.R.S.)

This function can't be seen under BIOS setup; and is always on whenever the system starts up.

However, it can prevent system hang-up due to inappropriate overclock actions.

When the system hangs up, S.R.S. will automatically log in the default BIOS setting, and all overclock settings will be re-configured.

E. Smart Fan Function

Smart Fan Function is under "Smart Fan Configuration" in "Advanced Menu".

This is a brilliant feature to control CPU/System Temperature vs. Fan speed.

When enabling Smart Fan function, Fan speed is controlled automatically by CPU/System temperature.

This function will protect CPU/System from overheat problem and maintain the system temperature at a safe level.

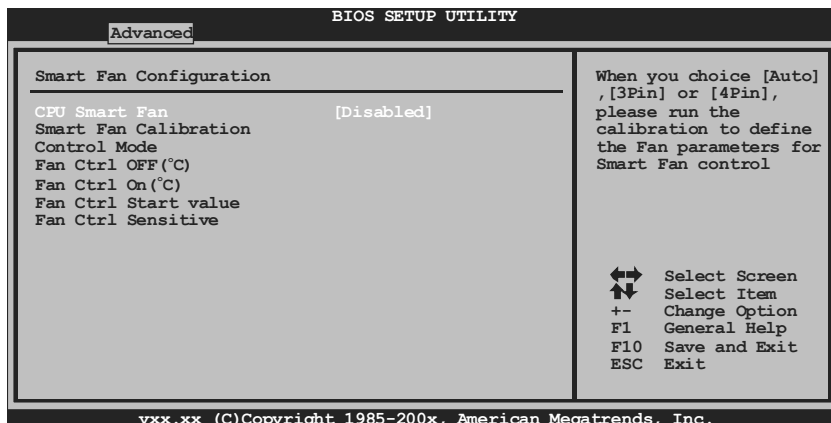
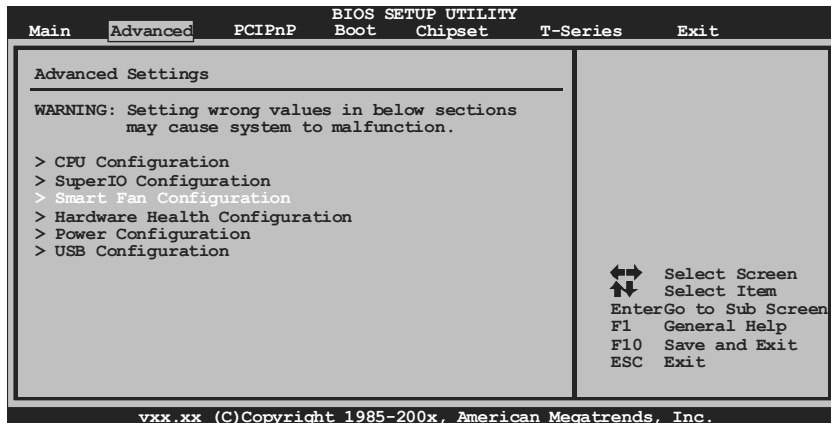

Smart Fan Calibration

Choose this item and then the BIOS will automatically test and detect the CPU/System fan functions and show CPU/System fan speed.

Control Mode

This item provides several operation modes of the fan.

Fan Ctrl OFF(°C)

If the CPU/System temperature is lower than the set value, the CPU/System fan will turn off. The range is from 0~127, with an interval of 1.

Fan Ctrl On(°C)

The CPU/System fan starts to work when CPU/System temperature arrives to this set value. The range is from 0~127, with an interval of 1.

Fan Ctrl Start Value

When CPU/System temperature arrives to the set value, the CPU/System fan will work under Smart Fan Function mode. The range is from 0~127, with an interval of 1.

Fan Ctrl Sensitive

Increasing the value of slope PWM will raise the speed of CPU/System fan. The range is from 1~127, with an interval of 1.

F. CMOS Reloading Program

It allows users to save different CMOS settings into BIOS-ROM. Users are able to reload any saved CMOS setting for customizing system configurations. Moreover, users are able to save an ideal overclock setting during overclock operation. There are 10 sets of record addresses in total, and users are able to name the CMOS data according to personal preference.

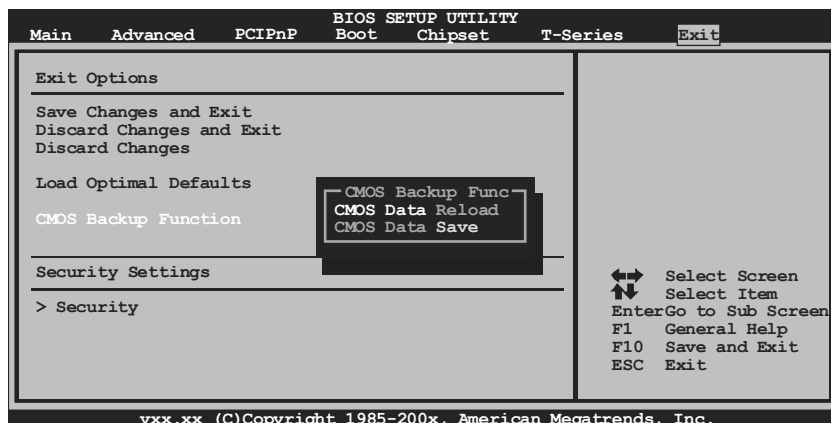

6.2 T-SERIES SOFTWARE

Installing T-Series Software

1. Insert the Setup CD to the optical drive. The drivers installation program would appear if the Auto-run function has been enabled.
2. Select **Software Installation**, and then click on the respective software title.
3. Follow the on-screen instructions to complete the installation.

Launching T-Series Software

After the installation process, you will see the software icon “T-Utility OverClock III” / “HW Monitor” / “eHOT Line” / “Tseries BIOS Update” appears on the desktop. Double-click the icon to launch T-Series utility.

OverClock 3

OverClock 3 is equipped with friendly interface and solid over-clock features, and it will help you easily do over-clocking under windows environment.

Double-click the desktop icon, OverClock 3 will be launched; the first window you will see is **Main Panel**. In this panel you will see current CPU Speed and CPU/Memory/PCI-E/PCI Clock.

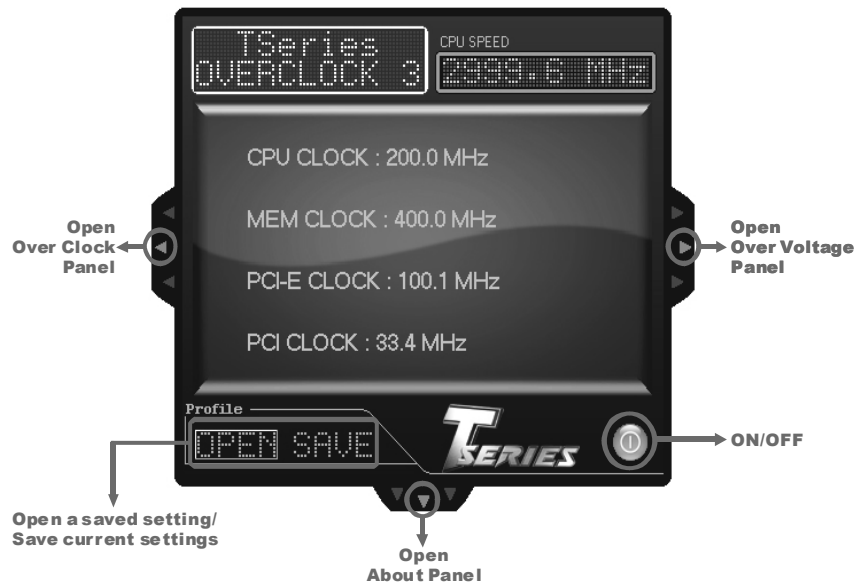

Over Clock Panel

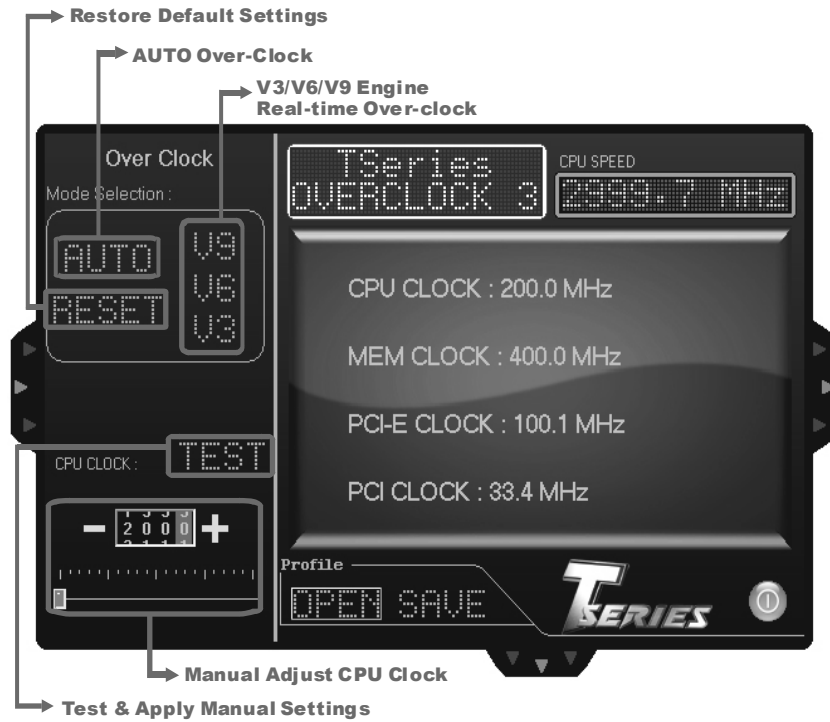

AUTO

User can click this button and the utility will set the best and stable performance and frequency automatically. A warning dialog as below will show up to notify you that the system may become unstable, click on “OK” to continue.

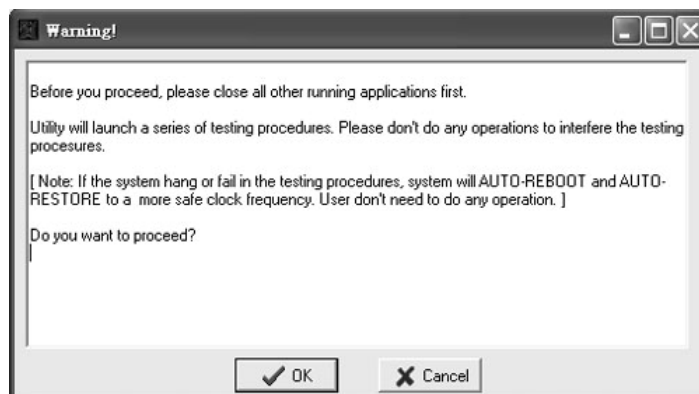

Then the utility will execute a series of testing until system fail. Then system will do fail-safe reboot by using Watchdog function. After reboot, launch the utility again and the utility will load the previously verified best and stable frequency.

V3 / V6 / V9

Provide user the ability to do real-time over-clock adjustment. For beginners in over-clock field, this is a powerful feature to increase system performance.

- **V3 Engine**
This engine will make a good over-clock performance.
- **V6 Engine**
This engine will make a better over-clock performance.
- **V9 Engine**
This engine will make a best over-clock performance.

TEST

You can also manually adjust CPU clock by pressing +/- button or moving the level bar. After manually adjust the CPU clock, you should click TEST button and the utility will proceed a testing for current frequency. If the testing is ok, then the current frequency will be saved into system registry. If the testing fails, system will do a fail-safe rebooting. After reboot, the utility will restore to the hardware default setting.

Warning

Manually over-clock is potentially dangerous, especially when the over-clocking percentage is over 110 %. We strongly recommend you test every speed you over-clock by click the TEST button. Or, you can just click AUTO over-clock button and let the Utility automatically get the best result for you.

RESET

Click this button and the utility will restore all values to the hardware default setting.

Over Voltage Panel

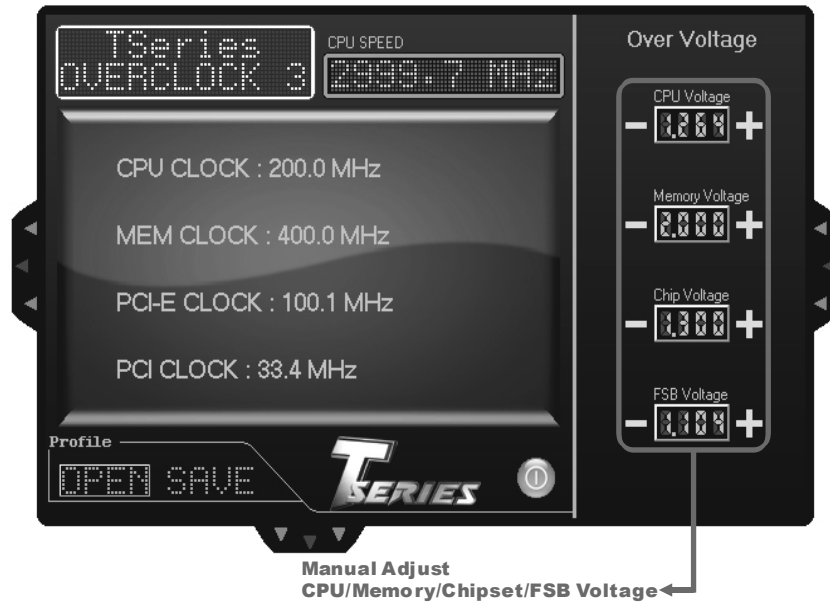

CPU Voltage

This function allows user to adjust CPU voltage. Click on “+” to increase or “-” to decrease the CPU voltage.

Memory Voltage

This function allows user to adjust Memory voltage. Click on “+” to increase or “-” to decrease the Memory voltage.

Chip Voltage

This function allows user to adjust Chipset voltage. Click on “+” to increase or “-” to decrease the Chipset voltage.

FSB Voltage

This function allows user to adjust FSB voltage. Click on “+” to increase or “-” to decrease the FSB voltage.

About Panel

In this panel, you can get model name and other system information that may related to over-clocking. You can also get the version number of this software.

Note

Because the Over Clock and Over Voltage features are controlled by several separate chipset, the utility divides these features to separate panels. If one chipset is not on board, the correlative button in Main panel will be disabled, but it will not interfere with other panels' functions. This property can make the utility more robust.

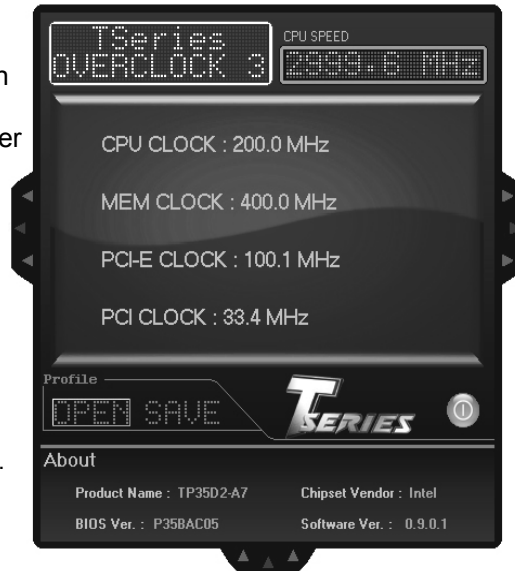

Hardware Monitor

HW Monitor is a monitor utility that helps you to maintain the health of the PC. It provides real-time information of CPU/GPU/System temperature, fan speed, and voltage.

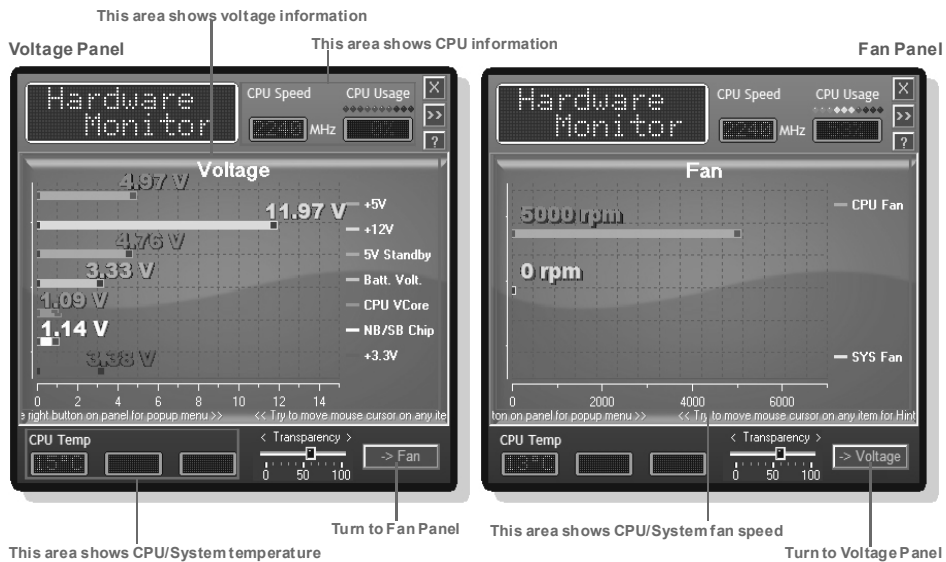

eHot-Line (Optional)

eHot-Line is a convenient utility that helps you to contact with our Tech-Support system. This utility will collect the system information which is useful for analyzing the problem you may have encountered, and then send these information to our tech-support department to help you fix the problem.

 Before you use this utility, please set Outlook Express as your default e-mail client application program.

* represents important information that you must provide. Without this information, you may not be able to send out the mail.

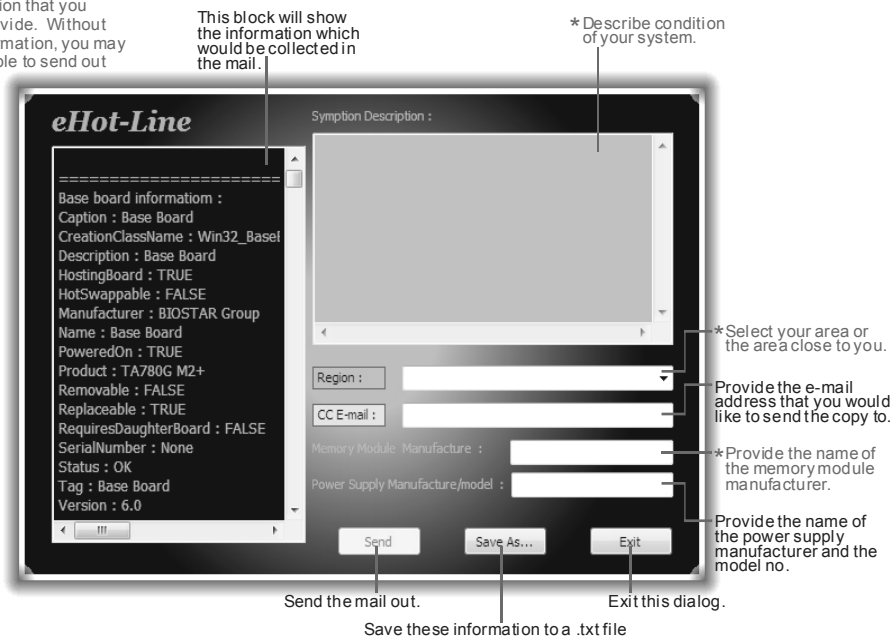

This block will show the information which would be collected in the mail.

* Describe condition of your system.

* Select your area or the area close to you.

Provide the e-mail address that you would like to send the copy to.

* Provide the name of the memory module manufacturer.

Provide the name of the power supply manufacturer and the model no.

Send the mail out.

Save these information to a .txt file

Exit this dialog.

After filling up this information, click **“Send”** to send the mail out. A warning dialog would appear asking for your confirmation; click **“Send”** to confirm or **“Do Not Send”** to cancel.

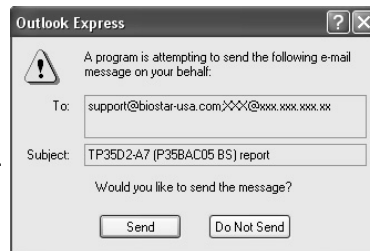

If you want to save this information to a .txt file, click **“Save As...”** and then you will see a saving dialog appears asking you to enter file name.

Enter the file name and then click “Save”. Your system information will be saved to a .txt file.

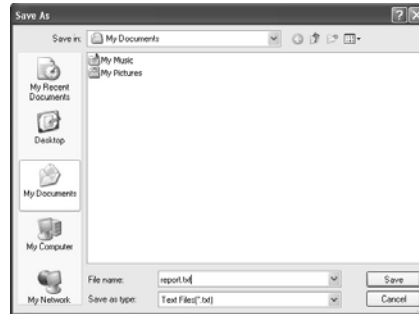

Open the saved .txt file, you will see your system information including motherboard/BIOS/CPU/video/device/OS information. This information is also included in the sent mail.



We will not share customer’s data with any other third parties, so please feel free to provide your system information while using eHot-Line service.



If you are not using Outlook Express as your default e-mail client application, you may need to save the system information to a .txt file and send the file to our tech support with other e-mail application. Go to the following web <http://www.biostar.com.tw/app/en-us/about/contact.php> for getting our contact information.

BIOS Update

BIOS Update is a convenient utility which allows you to update your motherboard BIOS under Windows system.

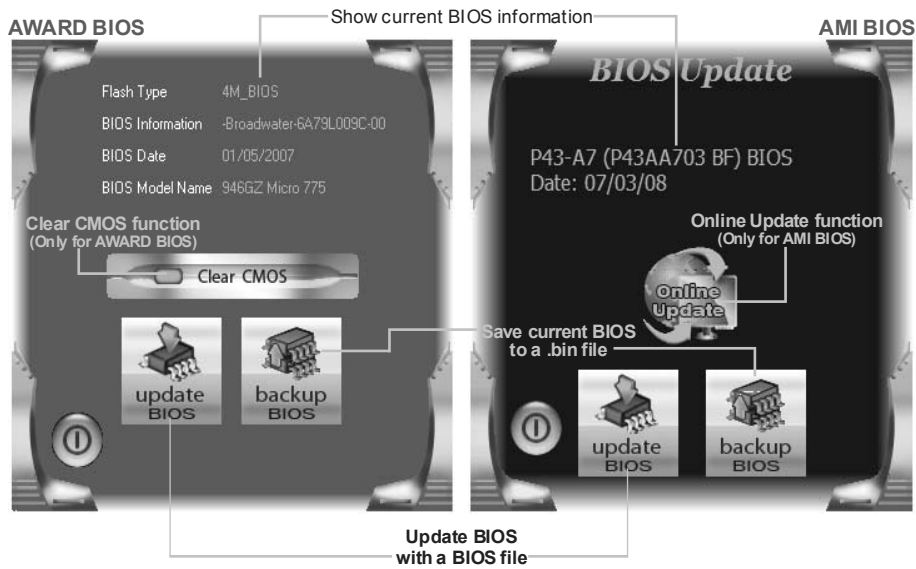

<Backup BIOS>

Once click on this button, the saving dialog will show. Choose the position to save file and enter file name. (We recommend that the file name should be English/number and no longer than 7 characters.) Then click **Save**.

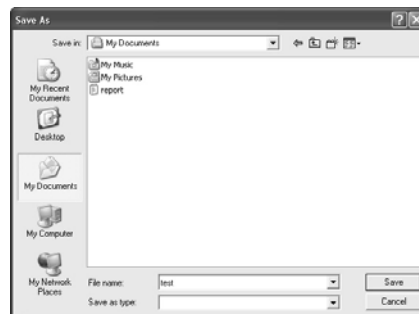

<Update BIOS>

Before doing this, please download the proper BIOS file from the website.

For AWARD BIOS, update BIOS procedure should be run with Clear CMOS function, so please check on Clear CMOS first.

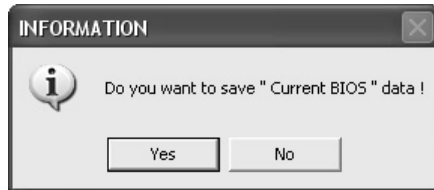
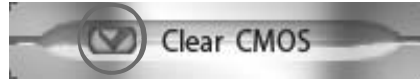

Then click Update BIOS button, a dialog will show for asking you backup current BIOS. Click **Yes** for BIOS backup and refer to the Backup BIOS procedure; or click **No** to skip this procedure.

After the BIOS Backup procedure, the open dialog will show for requesting the BIOS file which is going to be updated. Please choose the proper BIOS file for updating, then click on **Open**.

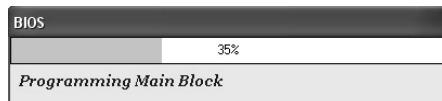
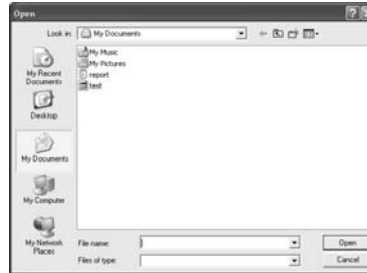

The utility will update BIOS with the proper BIOS file, and this process may take minutes. Please do not open any other applications during this process.

After the BIOS Update process, click on **OK** to restart the system.

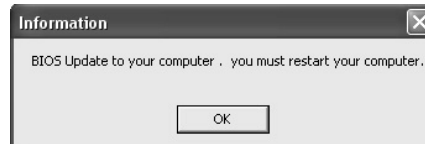

While the system boots up and the full screen logo shows, press  <Delete> key to enter BIOS setup.

In the BIOS setup, use the **Load Optimized Defaults** function and then **Save and Exit Setup** to exit BIOS setup. BIOS Update is completed.

<Online Update> (for AMI BIOS only)

Automatically download and update the latest BIOS via internet; **make sure that the computer is connected to the internet before using this function.**

After clicking on the **Online Update** button, the utility will search for the latest BIOS from internet. If there is a new BIOS version, the utility will ask you to download it. Click **Yes** to proceed.

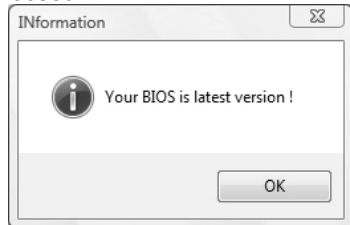
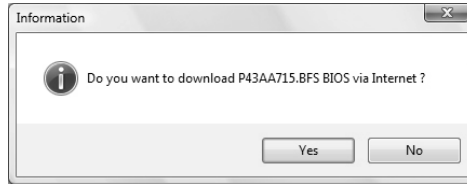

If there is no other newer BIOS version, the utility will also tell you that your BIOS has been the latest version.

Download completes; the utility will ask you to program (update) the BIOS. Click **Yes** to proceed.

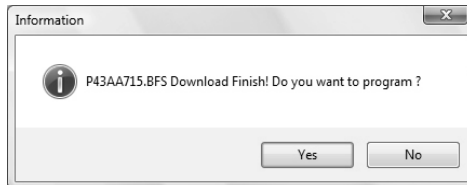

The programming procedure may take minutes, **please do not make any operation during the programming process.**

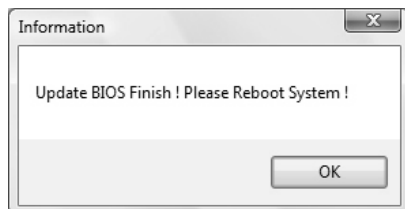

After the updating process, the utility will ask you to reboot the system. Click **OK** to reboot.

While the system boots up and the full screen logo shows, press  <Delete> key to enter BIOS setup.

In the BIOS setup, use the **Load Optimized Defaults** function and then **Save and Exit Setup** to exit BIOS setup. Online Update is completed.



All the information and content above about the T-Series software are subject to be changed without notice. For better performance, the software is being continuously updated. The information and pictures described above are for your reference only. The actual information and settings on board may be slightly different from this manual.

CHAPTER 7: USEFUL HELP

7.1 DRIVER INSTALLATION NOTE

After you installed your operating system, please insert the Fully Setup Driver CD into your optical drive and install the driver for better system performance.

You will see the following window after you insert the CD

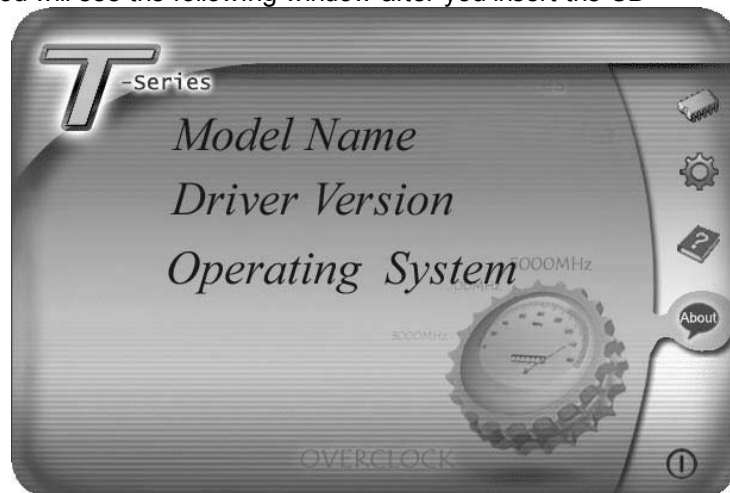

The setup guide will auto detect your motherboard and operating system.

Note:

If this window didn't show up after you insert the Driver CD, please use file browser to locate and execute the file **SETUP.EXE** under your optical drive.

A. Driver Installation

To install the driver, please click on the Driver icon. The setup guide will list the compatible driver for your motherboard and operating system. Click on each device driver to launch the installation program.

B. Software Installation

To install the software, please click on the Software icon. The setup guide will list the software available for your system, click on each software title to launch the installation program.

C. Manual

Aside from the paperback manual, we also provide manual in the Driver CD. Click on the Manual icon to browse for available manual.

Note:

You will need Acrobat Reader to open the manual file. Please download the latest version of Acrobat Reader software from <http://www.adobe.com/products/acrobat/readstep2.html>

7.2 EXTRA INFORMATION

CPU Overheated

If the system shutdown automatically after power on system for seconds, that means the CPU protection function has been activated.

When the CPU is over heated, the motherboard will shutdown automatically to avoid a damage of the CPU, and the system may not power on again.

In this case, please double check:

1. The CPU cooler surface is placed evenly with the CPU surface.
2. CPU fan is rotated normally.
3. CPU fan speed is fulfilling with the CPU speed.

After confirmed, please follow steps below to relief the CPU protection function.

1. Remove the power cord from power supply for seconds.
2. Wait for seconds.
3. Plug in the power cord and boot up the system.

Or you can:

1. Clear the CMOS data.
(See "Close CMOS Header: JCMOS1" section)
2. Wait for seconds.
3. Power on the system again.

7.3 AMI BIOS BEEP CODE

Boot Block Beep Codes

Number of Beeps	Description
1	No media present. (Insert diskette in floppy drive A:)
2	"AMIBOOT.ROM" file not found in root directory of diskette in A:
3	Insert next diskette if multiple diskettes are used for recovery
4	Flash Programming successful
5	File read error
7	No Flash EPROM detected
10	Flash Erase error
11	Flash Program error
12	"AMIBOOT.ROM" file size error
13	BIOS ROM image mismatch (file layout does not match image present in flash device)

POST BIOS Beep Codes

Number of Beeps	Description
1	Memory refresh timer error
3	Base memory read/write test error
6	Keyboard controller BAT command failed
7	General exception error (processor exception interrupt error)
8	Display memory error (system video adapter)

Troubleshooting POST BIOS Beep Codes

Number of Beeps	Troubleshooting Action
1, 3	Reseat the memory, or replace with known good modules.
6, 7	<p>Fatal error indicating a serious problem with the system. Consult your system manufacturer. Before declaring the motherboard beyond all hope, eliminate the possibility of interference by a malfunctioning add-in card. Remove all expansion cards except the video adapter.</p> <ul style="list-style-type: none"> ● If beep codes are generated when all other expansion cards are absent, consult your system manufacturer's technical support. ● If beep codes are not generated when all other expansion cards are absent, one of the add-in cards is causing the malfunction. Insert the cards back into the system one at a time until the problem happens again. This will reveal the malfunctioning card.
8	If the system video adapter is an add-in card, replace or reseat the video adapter. If the video adapter is an integrated part of the system board, the board may be faulty.

7.4 TROUBLESHOOTING

Probable	Solution
<ol style="list-style-type: none"> 1. There is no power in the system. Power LED does not shine; the fan of the power supply does not work 2. Indicator light on keyboard does not shine. 	<ol style="list-style-type: none"> 1. Make sure power cable is securely plugged in. 2. Replace cable. 3. Contact technical support.
<p>System is inoperative. Keyboard lights are on, power indicator lights are lit, and hard drives are running.</p>	<p>Using even pressure on both ends of the DIMM, press down firmly until the module snaps into place.</p>
<p>System does not boot from a hard disk drive, but can be booted from optical drive.</p>	<ol style="list-style-type: none"> 1. Check cable running from disk to disk controller board. Make sure both ends are securely plugged in; check the drive type in the standard CMOS setup. 2. Backing up the hard drive is extremely important. All hard disks are capable of breaking down at any time.
<p>System only boots from an optical drive. Hard disks can be read, applications can be used, but system fails to boot from a hard disk.</p>	<ol style="list-style-type: none"> 1. Back up data and applications files. 2. Reformat the hard drive. Re-install applications and data using backup disks.
<p>Screen message shows "Invalid Configuration" or "CMOS Failure."</p>	<p>Review system's equipment. Make sure correct information is in setup.</p>
<p>System cannot boot after user installs a second hard drive.</p>	<ol style="list-style-type: none"> 1. Set master/slave jumpers correctly. 2. Run SETUP program and select correct drive types. Call the drive manufacturers for compatibility with other drives.

APPENDIX: SPEC IN OTHER LANGUAGES

GERMAN

	TA780GE/TA760GE/ TA785GE/TA785GE 128M	TA790GXE
CPU	<p>Socket AM2+</p> <p>AMD Athlon 64 / Athlon 64 FX / Athlon 64 X2 / Sempron / Phenom / Phenom II Prozessoren</p> <p>Die AMD 64-Architektur unterstützt eine 32-Bit- und 64-Bit-Datenverarbeitung</p> <p>Unterstützt Hyper Transport 3.0</p>	<p>Socket AM2+</p> <p>AMD Athlon 64 / Athlon 64 FX / Athlon 64 X2 / Sempron / Phenom / Phenom II Prozessoren</p> <p>Die AMD 64-Architektur unterstützt eine 32-Bit- und 64-Bit-Datenverarbeitung</p> <p>Unterstützt Hyper Transport 3.0</p>
FSB	<p>Unterstützt HyperTransport 3.0 mit einer Bandbreite von bis zu 5.2 GT/s</p> <p>Bandbreite von bis zu 4.4 GT/s (TA785GE/TA785GE 128M)</p>	<p>Unterstützt HyperTransport 3.0 mit einer Bandbreite von bis zu 5.2 GT/s</p>
Chipsatz	<p>AMD 780G (TA780GE)</p> <p>AMD 760G (TA760GE)</p> <p>AMD 785G (TA785GE/TA785GE 128M)</p> <p>AMD SB710</p>	<p>AMD 790GX</p> <p>AMD SB750</p>
Super E/A	<p>ITE IT8718F</p> <p>Bietet die häufig verwendeten alten Super E/A-Funktionen.</p> <p>Low Pin Count-Schnittstelle</p> <p>Umgebungskontrolle, Hardware-Überwachung</p> <p>Lüfterdrehzahl-Controller</p> <p>"Smart Guardian"-Funktion von ITE</p>	<p>ITE IT8718F</p> <p>Bietet die häufig verwendeten alten Super E/A-Funktionen.</p> <p>Low Pin Count-Schnittstelle</p> <p>Umgebungskontrolle, Hardware-Überwachung</p> <p>Lüfterdrehzahl-Controller</p> <p>"Smart Guardian"-Funktion von ITE</p>
Arbeitsspeicher	<p>DDR2 DIMM-Steckplätze x 4</p> <p>Jeder DIMM unterstützt 256MB/512MB/1GB/2GB/4GB DDR2.</p> <p>Max. 16GB Arbeitsspeicher</p> <p>Dual-Kanal DDR2 Speichermodul</p> <p>Unterstützt DDR2 533 / 667 / 800</p> <p>Unterstützt DDR2 1066 (by AM2+/AM3 CPU) registrierte DIMMs. ECC DIMMs werden nicht unterstützt.</p>	<p>DDR2 DIMM-Steckplätze x 4</p> <p>Jeder DIMM unterstützt 256MB/512MB/1GB/2GB/4GB DDR2.</p> <p>Max. 16GB Arbeitsspeicher</p> <p>Dual-Kanal DDR2 Speichermodul</p> <p>Unterstützt DDR2 533 / 667 / 800</p> <p>Unterstützt DDR2 1066 (by AM2+/AM3 CPU) registrierte DIMMs. ECC DIMMs werden nicht unterstützt.</p>
Grafik	<p>780G (HD3200)/760G (HD3000)/785G(HD4200)</p> <p>Onboard side port memory 128MB DDR2 (TA785GE 128M Only)</p> <p>Max. 512MB gemeinsam benutzter Videospeicher</p> <p>Unterstützt DX10/DVI</p> <p>Unterstützt Hybrid CrossFireX (by ATI driver)</p>	<p>790GX (HD3300)</p> <p>Onboard side port memory 128MB DDR2</p> <p>Max. 512MB gemeinsam benutzter Videospeicher</p> <p>Unterstützt DX10/DVI</p> <p>Unterstützt Hybrid CrossFireX (by ATI driver)</p>

TA780GE/TA760GE/TA785GE/TA785GE 128M/TA790GXE

	TA780GE/TA760GE/ TA785GE/TA785GE 128M		TA790GXE	
IDE	AMD SB710 Ultra DMA 33 / 66 / 100 / 133 Bus Master-Modus Unterstützt PIO-Modus 0~4,		AMD SB750 Ultra DMA 33 / 66 / 100 / 133 Bus Master-Modus Unterstützt PIO-Modus 0~4,	
SATA II	AMD SB710 Datentransferrate bis zu 3Gb/s Konform mit der SATA-Spezifikation Version 2.0. Unterstützt RAID 0,1,1+0		AMD SB750 Datentransferrate bis zu 3Gb/s Konform mit der SATA-Spezifikation Version 2.0. Unterstützt RAID 0,1,5,1+0	
LAN	Realtek RTL 8111DL 10 / 100 / 1000 Mb/s Auto-Negotiation Halb-/ Voll duplex-Funktion		Realtek RTL 8111DL 10 / 100 / 1000 Mb/s Auto-Negotiation Halb-/ Voll duplex-Funktion	
Audio-Codec	ALC662 5.1-Kanal-Audioausgabe Unterstützt High-Definition Audio		ALC662 5.1-Kanal-Audioausgabe Unterstützt High-Definition Audio	
Steckplätze	PCI Steckplatz x2 PCI Express Gen2 x16 Steckplatz x1		PCI Steckplatz x2 PCI Express Gen2 x16 Steckplatz x1	
Onboard-Anschluss	Diskettenlaufwerkanschluss x1 IDE-Anschluss x1 SATA-Anschluss x6 Fronttafelanschluss x1 Front-Audioanschluss x1 CD-IN-Anschluss x1 S/PDIF Ausgangsanschluss x1 CPU-Lüfter-Sockel x1 System-Lüfter-Sockel x2 "CMOS löschen"-Sockel x1 USB-Anschluss x3 Serieller Anschluss x1 Stromanschluss (24-polig) x1 Stromanschluss (4-polig) x1		Diskettenlaufwerkanschluss x1 IDE-Anschluss x1 SATA-Anschluss x6 Fronttafelanschluss x1 Front-Audioanschluss x1 CD-IN-Anschluss x1 S/PDIF Ausgangsanschluss x1 CPU-Lüfter-Sockel x1 System-Lüfter-Sockel x2 "CMOS löschen"-Sockel x1 USB-Anschluss x3 Serieller Anschluss x1 Stromanschluss (24-polig) x1 Stromanschluss (4-polig) x1	
Rückseiten-E/A	PS/2-Tastatur x1 PS/2-Maus x1 VGA-Anschluss x1 DVI-D-Anschluss x1 LAN-Anschluss x1 USB-Anschluss x4 Audioanschluss x3		PS/2-Tastatur x1 PS/2-Maus x1 VGA-Anschluss x1 DVI-D-Anschluss x1 LAN-Anschluss x1 USB-Anschluss x4 Audioanschluss x3	
Platinengröße	233 mm (B) X 244 mm (L)		233 mm (B) X 244 mm (L)	
OS-Unterstützung	Windows XP / Vista / 7 Biostar behält sich das Recht vor, ohne Ankündigung die Unterstützung für ein Betriebssystem hinzuzufügen oder zu entfernen.		Windows XP / Vista / 7 Biostar behält sich das Recht vor, ohne Ankündigung die Unterstützung für ein Betriebssystem hinzuzufügen oder zu entfernen.	

FRENCH

	TA780GE/TA760GE/ TA785GE/TA785GE 128M	TA790GXE
UC	Socket AM2+ Processeurs AMD Athlon 64 / Athlon 64 FX / Athlon 64 X2 / Sempron / Phenom / Phenom II L'architecture AMD 64 permet le calcul 32 et 64 bits Prend en charge Hyper Transport 3.0	Socket AM2+ Processeurs AMD Athlon 64 / Athlon 64 FX / Athlon 64 X2 / Sempron / Phenom / Phenom II L'architecture AMD 64 permet le calcul 32 et 64 bits Prend en charge Hyper Transport 3.0
Bus frontal	Prend en charge Hyper Transport 3.0 jusqu'à une bande passante de 5.2 GT/s Prend en charge Hyper Transport 3.0 jusqu'à une bande passante de 4.4 GT/s (TA785GE/TA785GE 128M)	Prend en charge Hyper Transport 3.0 jusqu'à une bande passante de 5.2 GT/s
Chipset	AMD 780G (TA780GE) AMD 760G (TA760GE) AMD 785G (TA785GE/TA785GE 128M) AMD SB710	AMD 790GX AMD SB750
Super E/S	ITE IT8718F Fournit la fonctionnalité de Super E/S patrimoniales la plus utilisée. Interface à faible compte de broches Initiatives de contrôle environnementales, Moniteur de matériel Contrôleur de vitesse de ventilateur Fonction "Gardien intelligent" de l'ITE	ITE IT8718F Fournit la fonctionnalité de Super E/S patrimoniales la plus utilisée. Interface à faible compte de broches Initiatives de contrôle environnementales, Moniteur de matériel Contrôleur de vitesse de ventilateur Fonction "Gardien intelligent" de l'ITE
Mémoire principale	Fentes DDR2 DIMM x 4 Chaque DIMM prend en charge des DDR2 de 256 Mo/512 Mo/1 Go/2 Go/4 Go Capacité mémoire maximale de 16 Go Module de mémoire DDR2 à mode à double voie Prend en charge la DDR2 533 / 667 / 800 Prend en charge la DDR2 1066 (by AM2+/AM3 CPU) Les DIMM à registres et DIMM avec code correcteurs d'erreurs ne sont pas prises en charge	Fentes DDR2 DIMM x 4 Chaque DIMM prend en charge des DDR2 de 256 Mo/512 Mo/1 Go/2 Go/4 Go Capacité mémoire maximale de 16 Go Module de mémoire DDR2 à mode à double voie Prend en charge la DDR2 533 / 667 / 800 Prend en charge la DDR2 1066 (by AM2+/AM3 CPU) Les DIMM à registres et DIMM avec code correcteurs d'erreurs ne sont pas prises en charge
Graphiques	780G (HD3200)/760G (HD3000)/785G(HD4200) Onboard side port memory 128MB DDR2 (TA785GE 128M Only) Mémoire vidéo partagée maximale de 512 Mo Prise en charge DX10/DVI Prise en charge Hybrid CrossFireX (by ATI driver)	790GX (HD3300) Onboard side port memory 128MB DDR2 Mémoire vidéo partagée maximale de 512 Mo Prise en charge DX10/DVI Prise en charge Hybrid CrossFireX (by ATI driver)

TA780GE/TA760GE/TA785GE/TA785GE 128M/TA790GXE

	TA780GE/TA760GE/ TA785GE/TA785GE 128M	TA790GXE
IDE	AMD SB710 Mode principale de Bus Ultra DMA 33 / 66 / 100 / 133 Prend en charge le mode PIO 0~4,	AMD SB750 Mode principale de Bus Ultra DMA 33 / 66 / 100 / 133 Prend en charge le mode PIO 0~4,
SATA II	AMD SB710 Taux de transfert jusqu'à 3 Go/s. Conforme à la spécification SATA Version 2.0 Prise en charge RAID 0,1,1+0	AMD SB750 Taux de transfert jusqu'à 3 Go/s. Conforme à la spécification SATA Version 2.0 Prise en charge RAID 0,1,5,1+0
LAN	Realtek RTL 8111DL 10 / 100 / 1000 Mb/s négociation automatique Half / Full duplex capability	Realtek RTL 8111DL 10 / 100 / 1000 Mb/s négociation automatique Half / Full duplex capability
Codec audio	ALC662 Sortie audio à 5.1 voies Prise en charge de l'audio haute définition	ALC662 Sortie audio à 5.1 voies Prise en charge de l'audio haute définition
Fentes	Fente PCI x2 Fente PCI Express Gen2 x16 x1	Fente PCI x2 Fente PCI Express Gen2 x16 x1
Connecteur embarqué	Connecteur de disquette x1 Connecteur de Port d'imprimante x1 Connecteur IDE x1 Connecteur SATA x6 Connecteur du panneau avant x1 Connecteur Audio du panneau avant x1 Connecteur d'entrée CD x1 Connecteur de sortie S/PDIF x1 Embase de ventilateur UC x1 Embase de ventilateur système x2 Embase d'effacement CMOS x1 Connecteur USB x3 Port série x1 Connecteur d'alimentation(24 broches) x1 Connecteur d'alimentation(4 broches) x1	Connecteur de disquette x1 Connecteur de Port d'imprimante x1 Connecteur IDE x1 Connecteur SATA x6 Connecteur du panneau avant x1 Connecteur Audio du panneau avant x1 Connecteur d'entrée CD x1 Connecteur de sortie S/PDIF x1 Embase de ventilateur UC x1 Embase de ventilateur système x2 Embase d'effacement CMOS x1 Connecteur USB x3 Port série x1 Connecteur d'alimentation(24 broches) x1 Connecteur d'alimentation(4 broches) x1
E/S du panneau arrière	Clavier PS/2 x1 Souris PS/2 x1 Port VGA x1 Port DVI-D x1 Port LAN x1 Port USB x4 Fiche audio x3	Clavier PS/2 x1 Souris PS/2 x1 Port VGA x1 Port DVI-D x1 Port LAN x1 Port USB x4 Fiche audio x3
Dimensions de la carte	233 mm (l) X 244 mm (H)	233 mm (l) X 244 mm (H)
Support SE	Windows XP / Vista / 7 Biostar se réserve le droit d'ajouter ou de supprimer le support de SE avec ou sans préavis.	Windows XP / Vista / 7 Biostar se réserve le droit d'ajouter ou de supprimer le support de SE avec ou sans préavis.

ITALIAN

	TA780GE/TA760GE/ TA785GE/TA785GE 128M	TA790GXE
CPU	Socket AM2+ Processori AMD Athlon 64 / Athlon 64 FX / Athlon 64 X2 / Sempron / Phenom / Phenom II L'architettura AMD 64 abilita la computazione 32 e 64 bit Supporto di Hyper Transport 3.0	Socket AM2+ Processori AMD Athlon 64 / Athlon 64 FX / Athlon 64 X2 / Sempron / Phenom / Phenom II L'architettura AMD 64 abilita la computazione 32 e 64 bit Supporto di Hyper Transport 3.0
FSB	Supporto di HyperTransport 3.0 fino a 5.2 GT/s di larghezza di banda Supporto di HyperTransport 3.0 fino a 4.4 GT/s di larghezza di banda (TA785GE/TA785GE 128M)	Supporto di HyperTransport 3.0 fino a 5.2 GT/s di larghezza di banda
Chipset	AMD 780G (TA780GE) AMD 760G (TA760GE) AMD 785G (TA785GE/TA785GE 128M) AMD SB710	AMD 790GX AMD SB750
Super I/O	ITE IT8718F Fornisce le funzionalità legacy Super I/O usate più comunemente. Interfaccia LPC (Low Pin Count) Funzioni di controllo dell'ambiente: Monitoraggio hardware Controller velocità ventolina Funzione "Smart Guardian" di ITE	ITE IT8718F Fornisce le funzionalità legacy Super I/O usate più comunemente. Interfaccia LPC (Low Pin Count) Funzioni di controllo dell'ambiente: Monitoraggio hardware Controller velocità ventolina Funzione "Smart Guardian" di ITE
Memoria principale	Alloggi DIMM DDR2 x 4 Ciascun DIMM supporta DDR2 256MB/512MB/1GB/2GB/4GB Capacità massima della memoria 16GB Modulo di memoria DDR2 a canale doppio Supporto di DDR2 533 / 667 / 800 Supporto di DDR2 1066 (by AM2+/AM3 CPU) DIMM registrati e DIMM ECC non sono supportati	Alloggi DIMM DDR2 x 4 Ciascun DIMM supporta DDR2 256MB/512MB/1GB/2GB/4GB Capacità massima della memoria 16GB Modulo di memoria DDR2 a canale doppio Supporto di DDR2 533 / 667 / 800 Supporto di DDR2 1066 (by AM2+/AM3 CPU) DIMM registrati e DIMM ECC non sono supportati
Grafica	780G (HD3200)/760G (HD3000)/785G(HD4200) Onboard side port memory 128MB DDR2 (TA785GE 128M Only) La memoria video condivisa massima è di 512 MB Supporto DX10/DVI Supporto Hybrid CrossFireX (by ATI driver)	790GX (HD3300) Onboard side port memory 128MB DDR2 La memoria video condivisa massima è di 512 MB Supporto DX10/DVI Supporto Hybrid CrossFireX (by ATI driver)

TA780GE/TA760GE/TA785GE/TA785GE 128M/TA790GXE

	TA780GE/TA760GE/ TA785GE/TA785GE 128M	TA790GXE
IDE	AMD SB710 Modalità Bus Master Ultra DMA 33 / 66 / 100 / 133 Supporto modalità PIO Mode 0-4	AMD SB750 Modalità Bus Master Ultra DMA 33 / 66 / 100 / 133 Supporto modalità PIO Mode 0-4
SATA II	AMD SB710 Velocità di trasferimento dei dati fino a 3 Gb/s. Compatibile specifiche SATA Versione 2.0. Supporto RAID 0,1,1+0	AMD SB750 Velocità di trasferimento dei dati fino a 3 Gb/s. Compatibile specifiche SATA Versione 2.0. Supporto RAID 0,1,5,1+0
LAN	Realtek RTL 8111DL Negoziazione automatica 10 / 100 / 1000 Mb/s Capacità Half / Full Duplex	Realtek RTL 8111DL Negoziazione automatica 10 / 100 / 1000 Mb/s Capacità Half / Full Duplex
Codec audio	ALC662 Uscita audio 5.1 canali Supporto audio High-Definition (HD)	ALC662 Uscita audio 5.1 canali Supporto audio High-Definition (HD)
Alloggi	Alloggio PCI x2 Alloggio PCI Express Gen2 x16 x1	Alloggio PCI x2 Alloggio PCI Express Gen2 x16 x1
Connettori su scheda	Connettore floppy x1 Connettore IDE x1 Connettore SATA x6 Connettore pannello frontale x1 Connettore audio frontale x1 Connettore CD-in x1 Connettore output S/PDIF x1 Collettore ventolina CPU x1 Collettore ventolina sistema x2 Collettore cancellazione CMOS x1 Connettore USB x3 Porta seriale x1 Connettore alimentazione(24 pin) x1 Connettore alimentazione(4 pin) x1	Connettore floppy x1 Connettore IDE x1 Connettore SATA x6 Connettore pannello frontale x1 Connettore audio frontale x1 Connettore CD-in x1 Connettore output S/PDIF x1 Collettore ventolina CPU x1 Collettore ventolina sistema x2 Collettore cancellazione CMOS x1 Connettore USB x3 Porta seriale x1 Connettore alimentazione(24 pin) x1 Connettore alimentazione(4 pin) x1
I/O pannello posteriore	Tastiera PS/2 x1 Mouse PS/2 x1 Porta VGA x1 Porta DVI-D x1 Porta LAN x1 Porta USB x4 Connettore audio x3	Tastiera PS/2 x1 Mouse PS/2 x1 Porta VGA x1 Porta DVI-D x1 Porta LAN x1 Porta USB x4 Connettore audio x3
Dimensioni scheda	233 mm (larghezza) x 244 mm (altezza)	233 mm (larghezza) x 244 mm (altezza)
Sistemi operativi supportati	Windows XP / Vista / 7 Biostar si riserva il diritto di aggiungere o rimuovere il supporto di qualsiasi sistema operativo senza preavviso.	Windows XP / Vista / 7 Biostar si riserva il diritto di aggiungere o rimuovere il supporto di qualsiasi sistema operativo senza preavviso.

SPANISH

	TA780GE/TA760GE/ TA785GE/TA785GE 128M	TA790GXE
CPU	<p>Conector AM2+</p> <p>Procesadores AMD Athlon 64 / Athlon 64 FX / Athlon 64 X2 / Sempron / Phenom / Phenom II</p> <p>La arquitectura AMD 64 permite el procesado de 32 y 64 bits</p> <p>Soporta las tecnologías Hyper Transport 3.0</p>	<p>Conector AM2+</p> <p>Procesadores AMD Athlon 64 / Athlon 64 FX / Athlon 64 X2 / Sempron / Phenom / Phenom II</p> <p>La arquitectura AMD 64 permite el procesado de 32 y 64 bits</p> <p>Soporta las tecnologías Hyper Transport 3.0</p>
FSB	<p>Admite HyperTransport 3.0 con un ancho de banda de hasta 5.2 GT/s</p> <p>Admite HyperTransport 3.0 con un ancho de banda de hasta 4.4 GT/s (TA785GE/TA785GE 128M)</p>	<p>Admite HyperTransport 3.0 con un ancho de banda de hasta 5.2 GT/s</p>
Conjunto de chips	<p>AMD 780G (TA780GE)</p> <p>AMD 760G (TA760GE)</p> <p>AMD 785G (TA785GE/TA785GE 128M)</p> <p>AMD SB710</p>	<p>AMD 790GX</p> <p>AMD SB750</p>
Súper E/S	<p>ITE IT8718F</p> <p>Le ofrece las funcionalidades heredadas de uso más común Súper E/S.</p> <p>Interfaz de cuenta Low Pin</p> <p>Iniciativas de control de entorno, Monitor hardware</p> <p>Controlador de velocidad de ventilador</p> <p>Función "Guardia inteligente" de ITE</p>	<p>ITE IT8718F</p> <p>Le ofrece las funcionalidades heredadas de uso más común Súper E/S.</p> <p>Interfaz de cuenta Low Pin</p> <p>Iniciativas de control de entorno, Monitor hardware</p> <p>Controlador de velocidad de ventilador</p> <p>Función "Guardia inteligente" de ITE</p>
Memoria principal	<p>Ranuras DIMM DDR2 x 4</p> <p>Cada DIMM admite DDR de 256MB/512MB/1GB/2GB/ 4GB</p> <p>Capacidad máxima de memoria de 16GB</p> <p>Módulo de memoria DDR2 de canal Doble</p> <p>Admite DDR2 de 533 / 667 / 800</p> <p>Admite DDR2 de 1066 (by AM2+/AM3 CPU)</p> <p>No admite DIMM registrados o DIMM compatibles con ECC</p>	<p>Ranuras DIMM DDR2 x 4</p> <p>Cada DIMM admite DDR de 256MB/512MB/1GB/2GB/ 4GB</p> <p>Capacidad máxima de memoria de 16GB</p> <p>Módulo de memoria DDR2 de canal Doble</p> <p>Admite DDR2 de 533 / 667 / 800</p> <p>Admite DDR2 de 1066 (by AM2+/AM3 CPU)</p> <p>No admite DIMM registrados o DIMM compatibles con ECC</p>
Gráficos	<p>780G (HD3200)/760G (HD3000)/785G(HD4200)</p> <p>Onboard side port memory 128MB DDR2 (TA785GE 128M Only)</p> <p>Memoria máxima de vídeo compartida de 512 MB</p> <p>Admite DX10/DVI</p> <p>Admite Hybrid CrossFireX (by ATI driver)</p>	<p>790GX (HD3300)</p> <p>Onboard side port memory 128MB DDR2</p> <p>Memoria máxima de vídeo compartida de 512 MB</p> <p>Admite DX10/DVI</p> <p>Admite Hybrid CrossFireX (by ATI driver)</p>

TA780GE/TA760GE/TA785GE/TA785GE 128M/TA790GXE

	TA780GE/TA760GE/ TA785GE/TA785GE 128M		TA790GXE	
IDE	AMD SB710 Modo bus maestro Ultra DMA 33 / 66 / 100 / 133 Soporte los Modos PIO 0~4,		AMD SB750 Modo bus maestro Ultra DMA 33 / 66 / 100 / 133 Soporte los Modos PIO 0~4,	
SATA II	AMD SB710 Tasas de transferencia de hasta 3 Gb/s. Compatible con la versión SATA 2.0. Admite RAID 0,1,1+0		AMD SB750 Tasas de transferencia de hasta 3 Gb/s. Compatible con la versión SATA 2.0. Admite RAID 0,1,5,1+0	
Red Local	Realtek RTL 8111DL Negociación de 10 / 100 / 1000 Mb/s Funciones Half / Full dúplex		Realtek RTL 8111DL Negociación de 10 / 100 / 1000 Mb/s Funciones Half / Full dúplex	
Códecs de sonido	ALC662 Salida de sonido de 5.1 canales Soporte de sonido de Alta Definición		ALC662 Salida de sonido de 5.1 canales Soporte de sonido de Alta Definición	
Ranuras	Ranura PCI	X2	Ranura PCI	X2
	Ranura PCI Express Gen2 x16	X1	Ranura PCI Express Gen2 x16	X1
Conectores en placa	Conector disco flexible	X1	Conector disco flexible	X1
	Conector IDE	X1	Conector IDE	X1
	Conector SATA	X6	Conector SATA	X6
	Conector de panel frontal	X1	Conector de panel frontal	X1
	Conector de sonido frontal	X1	Conector de sonido frontal	X1
	Conector de entrada de CD	X1	Conector de entrada de CD	X1
	Conector de salida S/PDIF	X1	Conector de salida S/PDIF	X1
	Cabecera de ventilador de CPU	X1	Cabecera de ventilador de CPU	X1
	Cabecera de ventilador de sistema	X2	Cabecera de ventilador de sistema	X2
	Cabecera de borrado de CMOS	X1	Cabecera de borrado de CMOS	X1
	Conector USB	X3	Conector USB	X3
	Puerto serie	X1	Puerto serie	X1
	Conector de alimentación(24 patillas)	X1	Conector de alimentación(24 patillas)	X1
	Conector de alimentación(4 patillas)	X1	Conector de alimentación(4 patillas)	X1
Panel trasero de E/S	Teclado PS/2	X1	Teclado PS/2	X1
	Ratón PS/2	X1	Ratón PS/2	X1
	Puerto VGA	X1	Puerto VGA	X1
	Puerto DVI-D	X1	Puerto DVI-D	X1
	Puerto de red local	X1	Puerto de red local	X1
	Puerto USB	X4	Puerto USB	X4
	Conector de sonido	X3	Conector de sonido	X3
Tamaño de la placa	233 mm. (A) X 244 mm. (H)		233 mm. (A) X 244 mm. (H)	
Soporte de sistema operativo	Windows XP / Vista / 7 Biostar se reserva el derecho de añadir o retirar el soporte de cualquier SO con o sin aviso previo.		Windows XP / Vista / 7 Biostar se reserva el derecho de añadir o retirar el soporte de cualquier SO con o sin aviso previo.	

PORTUGUESE

	TA780GE/TA760GE/ TA785GE/TA785GE 128M	TA790GXE
CPU	Socket AM2+ Processadores AMD Athlon 64 / Athlon 64 FX / Athlon 64 X2 / Sempron / Phenom / Phenom II A arquitectura AMD 64 permite uma computação de 32 e 64 bits Suporta as tecnologias Hyper Transport 3.0	Socket AM2+ Processadores AMD Athlon 64 / Athlon 64 FX / Athlon 64 X2 / Sempron / Phenom / Phenom II A arquitectura AMD 64 permite uma computação de 32 e 64 bits Suporta as tecnologias Hyper Transport 3.0
FSB	Suporta a tecnologia HyperTransport 3.0 com uma largura de banda até 5.2 GT/s Suporta a tecnologia HyperTransport 3.0 com uma largura de banda até 4.4 GT/s (TA785GE/TA785GE 128M)	Suporta a tecnologia HyperTransport 3.0 com uma largura de banda até 5.2 GT/s
Chipset	AMD 780G (TA780GE) AMD 760G (TA760GE) AMD 785G (TA785GE/TA785GE 128M) AMD SB710	AMD 790GX AMD SB750
Especificação do Super I/O	ITE IT8718F Proporciona as funcionalidades mais utilizadas em termos da especificação Super I/O. Interface LPC (Low Pin Count). Iniciativas para controlo do ambiente Monitorização do hardware Controlador da velocidade da ventoinha Função "Smart Guardian" da ITE	ITE IT8718F Proporciona as funcionalidades mais utilizadas em termos da especificação Super I/O. Interface LPC (Low Pin Count). Iniciativas para controlo do ambiente Monitorização do hardware Controlador da velocidade da ventoinha Função "Smart Guardian" da ITE
Memória principal	Ranhuras DIMM DDR2 x 4 Cada módulo DIMM suporta uma memória DDR2 de 256MB/512MB/ 1GB/2GB/4GB Capacidade máxima de memória: 16GB Módulo de memória DDR2 de canal duplo Suporta módulos DDR2 533 / 667 / 800 Suporta módulos DDR2 1066 (by AM2+/AM3 CPU) Os módulos DIMM registados e os DIMM ECC não são suportados	Ranhuras DIMM DDR2 x 4 Cada módulo DIMM suporta uma memória DDR2 de 256MB/512MB/ 1GB/2GB/4GB Capacidade máxima de memória: 16GB Módulo de memória DDR2 de canal duplo Suporta módulos DDR2 533 / 667 / 800 Suporta módulos DDR2 1066 (by AM2+/AM3 CPU) Os módulos DIMM registados e os DIMM ECC não são suportados
Placa gráfica	780G (HD3200)/760G (HD3000)/785G(HD4200) Onboard side port memory 128MB DDR2 (TA785GE 128M Only) Memória de vídeo máxima partilhada: 512 MB Suporta as funções DX10/DVI Suporta as funções Hybrid CrossFireX (by ATI driver)	790GX (HD3300) Onboard side port memory 128MB DDR2 Memória de vídeo máxima partilhada: 512 MB Suporta as funções DX10/DVI Suporta as funções Hybrid CrossFireX (by ATI driver)

TA780GE/TA760GE/TA785GE/TA785GE 128M/TA790GXE

	TA780GE/TA760GE/ TA785GE/TA785GE 128M	TA790GXE
IDE	AMD SB710 Modo Bus master Ultra DMA 33 / 66 / 100 / 133 Suporta o modo PIO 0~4,	AMD SB750 Modo Bus master Ultra DMA 33 / 66 / 100 / 133 Suporta o modo PIO 0~4,
SATA II	AMD SB710 Velocidades de transmissão de dados até 3 Gb/s. Compatibilidade com a especificação SATA versão 2.0. Suporta as funções RAID 0,1,1+0	AMD SB750 Velocidades de transmissão de dados até 3 Gb/s. Compatibilidade com a especificação SATA versão 2.0. Suporta as funções RAID 0,1,5,1+0
LAN	Realtek RTL 8111DL Auto negociação de 10 / 100 / 1000 Mb/s Capacidade semi/full-duplex	Realtek RTL 8111DL Auto negociação de 10 / 100 / 1000 Mb/s Capacidade semi/full-duplex
Codec de som	ALC662 Saída de áudio de 5.1 canais Suporta a especificação High-Definition Audio	ALC662 Saída de áudio de 5.1 canais Suporta a especificação High-Definition Audio
Ranhuras	Ranhura PCI x2 Ranhura PCI Express Gen2 x16 x1	Ranhura PCI x2 Ranhura PCI Express Gen2 x16 x1
Conectores na placa	Conector da unidade de disquetes x1 Conector IDE x1 Conector SATA x6 Conector do painel frontal x1 Conector de áudio frontal x1 Conector para entrada de CDs x1 Conector de saída S/PDIF x1 Conector da ventoinha da CPU x1 Conector da ventoinha do sistema x2 Conector para limpeza do CMOS x1 Conector USB x3 Porta série x1 Conector de alimentação (24 pinos) x1 Conector de alimentação (4 pinos) x1	Conector da unidade de disquetes x1 Conector IDE x1 Conector SATA x6 Conector do painel frontal x1 Conector de áudio frontal x1 Conector para entrada de CDs x1 Conector de saída S/PDIF x1 Conector da ventoinha da CPU x1 Conector da ventoinha do sistema x2 Conector para limpeza do CMOS x1 Conector USB x3 Porta série x1 Conector de alimentação (24 pinos) x1 Conector de alimentação (4 pinos) x1
Entradas/Saídas no painel traseiro	Teclado PS/2 x1 Rato PS/2 x1 Porta VGA x1 Porta DVI-D x1 Porta LAN x1 Porta USB x4 Tomada de áudio x3	Teclado PS/2 x1 Rato PS/2 x1 Porta VGA x1 Porta DVI-D x1 Porta LAN x1 Porta USB x4 Tomada de áudio x3
Tamanho da placa	233 mm (L) X 244 mm (A)	233 mm (L) X 244 mm (A)
Sistemas operativos suportados	Windows XP / Vista / 7 A Biostar reserva-se o direito de adicionar ou remover suporte para qualquer sistema operativo com ou sem aviso prévio.	Windows XP / Vista / 7 A Biostar reserva-se o direito de adicionar ou remover suporte para qualquer sistema operativo com ou sem aviso prévio.

POLISH

	TA780GE/TA760GE/ TA785GE/TA785GE 128M	TA790GXE
Procesor	Socket AM2+ AMD Athlon 64 / Athlon 64 FX / Athlon 64 X2 / Sempron / Phenom / Phenom II Procesory Architektura AMD 64 umożliwia przetwarzanie 32 i 64 bitowe Obsługa Hyper Transport 3.0	Socket AM2+ AMD Athlon 64 / Athlon 64 FX / Athlon 64 X2 / Sempron / Phenom / Phenom II Procesory Architektura AMD 64 umożliwia przetwarzanie 32 i 64 bitowe Obsługa Hyper Transport 3.0
FSB	Obsługa HyperTransport 3.0 o szerokości pasma do 5.2 GT/s Obsługa HyperTransport 3.0 o szerokości pasma do 4.4 GT/s (TA785GE/TA785GE 128M)	Obsługa HyperTransport 3.0 o szerokości pasma do 5.2 GT/s
Chipset	AMD 780G (TA780GE) AMD 760G (TA760GE) AMD 785G (TA785GE/TA785GE 128M) AMD SB710	AMD 790GX AMD SB750
Pamięć główna	Gniazda DDR2 DIMM x 4 Każde gniazdo DIMM obsługuje moduły 256MB/512MB/1GB/2GB/4GB DDR2 Maks. wielkość pamięci 16GB Moduł pamięci DDR2 z trybem podwójnego kanału Obsługa DDR2 533 / 667 / 800 Obsługa DDR2 1066 (by AM2+/AM3 CPU) Brak obsługi Registered DIMM oraz ECC DIMM	Gniazda DDR2 DIMM x 4 Każde gniazdo DIMM obsługuje moduły 256MB/512MB/1GB/2GB/4GB DDR2 Maks. wielkość pamięci 16GB Moduł pamięci DDR2 z trybem podwójnego kanału Obsługa DDR2 533 / 667 / 800 Obsługa DDR2 1066 (by AM2+/AM3 CPU) Brak obsługi Registered DIMM oraz ECC DIMM
Grafika	780G (HD3200)/760G (HD3000)/785G(HD4200) Onboard side port memory 128MB DDR2 (TA785GE 128M Only) Maks. wielkość współdzielonej pamięci video wynosi 512 MB Obsługa DX10/DVI Obsługa Hybrid CrossFireX (by ATI driver)	790GX (HD3300) Onboard side port memory 128MB DDR2 Maks. wielkość współdzielonej pamięci video wynosi 512 MB Obsługa DX10/DVI Obsługa Hybrid CrossFireX (by ATI driver)
Super I/O	ITE IT8718F Zapewnia najbardziej powszechne funkcje Super I/O. Interfejs Low Pin Count Funkcje kontroli warunków pracy, Monitor H/W Kontroler prędkości wentylatora Funkcja ITE "Smart Guardian"	ITE IT8718F Zapewnia najbardziej powszechne funkcje Super I/O. Interfejs Low Pin Count Funkcje kontroli warunków pracy, Monitor H/W Kontroler prędkości wentylatora Funkcja ITE "Smart Guardian"

TA780GE/TA760GE/TA785GE/TA785GE 128M/TA790GXE

	TA780GE/TA760GE/ TA785GE/TA785GE 128M	TA790GXE
IDE	AMD SB710 Ultra DMA 33 / 66 / 100 / 133 Tryb Bus Master obsługa PIO tryb 0~4,	AMD SB750 Ultra DMA 33 / 66 / 100 / 133 Tryb Bus Master obsługa PIO tryb 0~4,
SATA II	AMD SB710 Transfer danych do 3 Gb/s. Zgodność ze specyfikacją SATA w wersji 2.0. Obsługa RAID 0,1,1+0	AMD SB750 Transfer danych do 3 Gb/s. Zgodność ze specyfikacją SATA w wersji 2.0. Obsługa RAID 0,1,5,1+0
LAN	Realtek RTL 8111DL 10 / 100 / 1000 Mb/s z automatyczną negocjacją szybkości Działanie w trybie półowicznego/pełnego dupleksu	Realtek RTL 8111DL 10 / 100 / 1000 Mb/s z automatyczną negocjacją szybkości Działanie w trybie półowicznego/pełnego dupleksu
Kodek dźwiękowy	ALC662 5.1 kanałowe wyjście audio Obsługa High-Definition Audio	ALC662 5.1 kanałowe wyjście audio Obsługa High-Definition Audio
Gniazda	Gniazdo PCI x2 Gniazdo PCI Express Gen2 x16 x1	Gniazdo PCI x2 Gniazdo PCI Express Gen2 x16 x1
Złącza wbudowane	Złącze napędu dyskietek x1 Złącze IDE x1 Złącze SATA x6 Złącze panela przedniego x1 Przednie złącze audio x1 Złącze wejścia CD x1 Złącze wyjścia S/PDIF x1 Złącze główkowe wentylatora procesora x1 Złącze główkowe wentylatora systemowego x2 Złącze główkowe kasowania CMOS x1 Złącze USB x3 Port szeregowy x1 Złącze zasilania (24 pinowe) x1 Złącze zasilania (4 pinowe) x1	Złącze napędu dyskietek x1 Złącze IDE x1 Złącze SATA x6 Złącze panela przedniego x1 Przednie złącze audio x1 Złącze wejścia CD x1 Złącze wyjścia S/PDIF x1 Złącze główkowe wentylatora procesora x1 Złącze główkowe wentylatora systemowego x2 Złącze główkowe kasowania CMOS x1 Złącze USB x3 Port szeregowy x1 Złącze zasilania (24 pinowe) x1 Złącze zasilania (4 pinowe) x1
Back Panel I/O	Klawiatura PS/2 x1 Mysz PS/2 x1 Port VGA x1 Port DVI-D x1 Port LAN x1 Port USB x4 Gniazdo audio x3	Klawiatura PS/2 x1 Mysz PS/2 x1 Port VGA x1 Port DVI-D x1 Port LAN x1 Port USB x4 Gniazdo audio x3
Wymiary płyty	233 mm (S) X 244 mm (W)	233 mm (S) X 244 mm (W)
Obsługa systemu operacyjne go	Windows XP / Vista / 7 Bióstar zastrzega sobie prawo dodawania lub odwoływania obsługi dowolnego systemu operacyjnego bez powiadomienia.	Windows XP / Vista / 7 Bióstar zastrzega sobie prawo dodawania lub odwoływania obsługi dowolnego systemu operacyjnego bez powiadomienia.

RUSSIAN

	TA780GE/TA760GE/ TA785GE/TA785GE 128M	TA790GXE
CPU (центральный процессор)	Гнездо AM2+ Процессоры AMD Athlon 64 / Athlon 64 FX / Athlon 64 X2 / Sempron / Phenom / Phenom II Архитектура AMD 64 разрешать обработка данных на 32 и 64 бит Поддержка Hyper Transport 3.0	Гнездо AM2+ Процессоры AMD Athlon 64 / Athlon 64 FX / Athlon 64 X2 / Sempron / Phenom / Phenom II Архитектура AMD 64 разрешать обработка данных на 32 и 64 бит Поддержка Hyper Transport 3.0
FSB	Поддержка HyperTransport 3.0 с пропускной способностью до 5.2 GT/s Поддержка HyperTransport 3.0 с пропускной способностью до 4.4 GT/s (TA785GE/TA785GE 128M)	Поддержка HyperTransport 3.0 с пропускной способностью до 5.2 GT/s
Набор микросхем	AMD 780G (TA780GE) AMD 760G (TA760GE) AMD 785G (TA785GE/TA785GE 128M) AMD SB710	AMD 790GX AMD SB750
Основная память	Слоты DDR2 DIMM x 4 Каждый модуль DIMM поддерживает 256МБ/512МБ/1 ГБ /2 ГБ/4 ГБ DDR2 Максимальная ёмкость памяти 16ГБ Модуль памяти с двухканальным режимом DDR2 Поддержка DDR2 533 / 667 / 800 Поддержка DDR2 1066 (by AM2+/AM3 CPU) Не поддерживает зарегистрированные модули DIMM and ECC DIMM	Слоты DDR2 DIMM x 4 Каждый модуль DIMM поддерживает 256МБ/512МБ/1 ГБ /2 ГБ/4 ГБ DDR2 Максимальная ёмкость памяти 16ГБ Модуль памяти с двухканальным режимом DDR2 Поддержка DDR2 533 / 667 / 800 Поддержка DDR2 1066 (by AM2+/AM3 CPU) Не поддерживает зарегистрированные модули DIMM and ECC DIMM
Графика	780G (HD3200)/760G (HD3000)/785G(HD4200) Onboard side port memory 128MB DDR2 (TA785GE 128M Only) Максимальная совместно используемая видео память составляет 512 МБ Поддержка DX10/DVI Поддержка Hybrid CrossFireX (by ATI driver)	790GX (HD3300) Onboard side port memory 128MB DDR2 Максимальная совместно используемая видео память составляет 512 МБ Поддержка DX10/DVI Поддержка Hybrid CrossFireX (by ATI driver)
Super I/O	ITE IT8718F Обеспечивает наиболее используемые действующие функциональные возможности Super I/O. Интерфейс с низким количеством выводов Инициативы по охране окружающей среды, Аппаратный монитор Регулятор скорости Функция ITE "Smart Guardian" (Интеллектуальная защита)	ITE IT8718F Обеспечивает наиболее используемые действующие функциональные возможности Super I/O. Интерфейс с низким количеством выводов Инициативы по охране окружающей среды, Аппаратный монитор Регулятор скорости Функция ITE "Smart Guardian" (Интеллектуальная защита)

TA780GE/TA760GE/TA785GE/TA785GE 128M/TA790GXE

	TA780GE/TA760GE/ TA785GE/TA785GE 128M		TA790GXE	
IDE	AMD SB710 Режим "хозяина" шины Ultra DMA 33 / 66 / 100 / 133 Поддержка режима PIO 0~4,		AMD SB750 Режим "хозяина" шины Ultra DMA 33 / 66 / 100 / 133 Поддержка режима PIO 0~4,	
SATA II	AMD SB710 скорость передачи данных до 3 гигабит/с. Соответствие спецификации SATA версия 2.0. Поддержка RAID 0,1,1+0		AMD SB750 скорость передачи данных до 3 гигабит/с. Соответствие спецификации SATA версия 2.0. Поддержка RAID 0,1,5,1+0	
Локальная сеть	Realtek RTL 8111DL Автоматическое согласование 10 / 100 / 1000 Мб/с Частичная / полная дуплексная способность		Realtek RTL 8111DL Автоматическое согласование 10 / 100 / 1000 Мб/с Частичная / полная дуплексная способность	
Звуковой кодек	ALC662 Звуковая поддержка High-Definition 5.1канальный звуковой выход		ALC662 Звуковая поддержка High-Definition 5.1канальный звуковой выход	
Слоты	Слот PCI x2 Слот PCI Express Gen2 x16 x1		Слот PCI x2 Слот PCI Express Gen2 x16 x1	
Встроенный разъем	Разъем НГМД x1 Разъем IDE x1 Разъем SATA x6 Разъем на лицевой панели x1 Входной звуковой разъем x1 Разъем ввода для CD x1 Разъем вывода для S/PDIF x1 Контактирующее приспособление вентилятора центрального процессора x1 Контактирующее приспособление вентилятора системы x2 Открытое контактирующее приспособление CMOS x1 USB-разъем x3 Последовательный порт x1 Разъем питания (24 вывод) x1 Разъем питания (4 вывод) x1		Разъем НГМД x1 Разъем IDE x1 Разъем SATA x6 Разъем на лицевой панели x1 Входной звуковой разъем x1 Разъем ввода для CD x1 Разъем вывода для S/PDIF x1 Контактирующее приспособление вентилятора центрального процессора x1 Контактирующее приспособление вентилятора системы x2 Открытое контактирующее приспособление CMOS x1 USB-разъем x3 Последовательный порт x1 Разъем питания (24 вывод) x1 Разъем питания (4 вывод) x1	
Задняя панель средств ввода-вывода	Клавиатура PS/2 x1 Мышь PS/2 x1 Порт VGA x1 Порт DVI-D x1 Порт LAN x1 USB-порт x4 Гнездо для подключения наушников x3		Клавиатура PS/2 x1 Мышь PS/2 x1 Порт VGA x1 Порт DVI-D x1 Порт LAN x1 USB-порт x4 Гнездо для подключения наушников x3	
Размер панели	233 мм (Ш) X 244 мм (В)		233 мм (Ш) X 244 мм (В)	
Поддержка OS	Windows XP / Vista / 7 Biostar сохраняет за собой право добавлять или удалять средства обеспечения для OS с или без предварительного уведомления.		Windows XP / Vista / 7 Biostar сохраняет за собой право добавлять или удалять средства обеспечения для OS с или без предварительного уведомления.	

ARABIC

TA790GXE	TA780GE/TA760GE/ TA785GE/TA785GE 128M	
AM2+ مقبس AMD Athlon 64 / Athlon 64 FX / Athlon 64 X2 / Sempron / Phenom / Phenom II معالجات إجراء العمليات الحاسوبية بسرعة 32 و 64 بت AMD 64 يمكن تقنية و 3.0 Hyper Transport دعم تقنية	AM2+ مقبس AMD Athlon 64 / Athlon 64 FX / Athlon 64 X2 / Sempron / Phenom / Phenom II معالجات إجراء العمليات الحاسوبية بسرعة 32 و 64 بت AMD 64 يمكن تقنية و 3.0 Hyper Transport دعم تقنية	وحدة المعالجة المركزية
5.2 GT/s يتردد يصل إلى 3.0 HyperTransport دعم تقنية	5.2 GT/s يتردد يصل إلى 3.0 HyperTransport دعم تقنية 4.4 GT/s يتردد يصل إلى 3.0 HyperTransport دعم تقنية (TA785GE/TA785GE 128M)	النافذ الأمامي الجانبي
AMD 790GX AMD SB750	AMD 780G (TA780GE) AMD 760G (TA760GE) AMD 785G (TA785GE/TA785GE 128M) AMD SB710	مجموعة الترانزح
عدد 4 قناة DDR2 DIMM سعة DDR2 تدعم ذاكرة من نوع DIMM ميجا 256/512 سعة DDR2 تدعم ذاكرة من نوع DIMM كل قناة بليت و 1 و 2 و 4 جيجا بليت سعة ذاكرة قصوى 16 جيجا بليت مزوجة القناة DDR2 وحدة ذاكرة ميجا بليت 800/667/533 سعات DDR2 تدعم الذاكرة من نوع 1066 (By AM2+/AM3) سعات DDR2 تدعم الذاكرة من نوع ميجا بليت (CPU) ECC وتلك التي لا تتوافق مع DIMM لا تدعم رقائق الذاكرة	عدد 4 قناة DDR2 DIMM سعة DDR2 تدعم ذاكرة من نوع DIMM ميجا 256/512 سعة DDR2 تدعم ذاكرة من نوع DIMM كل قناة بليت و 1 و 2 و 4 جيجا بليت سعة ذاكرة قصوى 16 جيجا بليت مزوجة القناة DDR2 وحدة ذاكرة ميجا بليت 800/667/533 سعات DDR2 تدعم الذاكرة من نوع 1066 (By AM2+/AM3) سعات DDR2 تدعم الذاكرة من نوع ميجا بليت (CPU) ECC وتلك التي لا تتوافق مع DIMM لا تدعم رقائق الذاكرة	الذاكرة الرئيسية
790GX (HD3300) Onboard side port memory 128MB DDR2 ميجا بليت 512 أقصى سعة لذاكرة الفيديو المشتركة DVI/DX10 دعم تقنية Hybrid CrossFireX (by ATI driver) دعم تقنية	780G (HD3200)/760G (HD3000)/785G (HD4200) Onboard side port memory 128MB DDR2 (TA785GE 128M Only) ميجا بليت 512 أقصى سعة لذاكرة الفيديو المشتركة DVI/DX10 دعم تقنية Hybrid CrossFireX (by ATI driver) دعم تقنية	بطاقة الرسومات
ITE IT8718F الأكثر استخداماً، Super I/O يوفر وظيفة Low Pin Count Interface دعم تقنية وسائل التحكم في البيئة: مراقب لمعرفة حالة الأجهزة مراقب في سرعة المروحة وظيفة "Smart Guardian" ووظيفة	ITE IT8718F الأكثر استخداماً، Super I/O يوفر وظيفة Low Pin Count Interface دعم تقنية وسائل التحكم في البيئة: مراقب لمعرفة حالة الأجهزة مراقب في سرعة المروحة وظيفة "Smart Guardian" ووظيفة	Super I/O

TA780GE/TA760GE/TA785GE/TA785GE 128M/TA790GXE

TA790GXE	TA780GE/TA760GE/ TA785GE/TA785GE 128M	
AMD SB750 Ultra DMA 33 / 66 / 100 / 133 نقل بتقنية وضع رئيسي PIO Mode 0~4 دعم وضع	AMD SB710 Ultra DMA 33 / 66 / 100 / 133 نقل بتقنية وضع رئيسي PIO Mode 0~4 دعم وضع	منفذ IDE
AMD SB750 نقل البيانات بسرعة تصل إلى 3 جيجابت/ثانية. 2.0 الإصدار SATA مطابقة لمواصفات RAID 0,1,1+0 دعم تقنية	AMD SB710 نقل البيانات بسرعة تصل إلى 3 جيجابت/ثانية. 2.0 الإصدار SATA مطابقة لمواصفات RAID 0,1,1+0 دعم تقنية	SATA II
Realtek RTL 8111DL تفاوض تلقائي 100/10 ميجا بايت / ثانية و1 جيجا بت/ثانية إمكانية النقل المزدوج الكامل/القصفي	Realtek RTL 8111DL تفاوض تلقائي 100/10 ميجا بايت / ثانية و1 جيجا بت/ثانية إمكانية النقل المزدوج الكامل/القصفي	شبكة داخلية
ALC662 تدعم تقنية الصوت عالي التعريف من 5.1 قنوات لخرج الصوت	ALC662 تدعم تقنية الصوت عالي التعريف من 5.1 قنوات لخرج الصوت	كوديك الصوت
قناة PCI عدد 2 قناة PCI Express Gen2 x16 عدد 1	قناة PCI عدد 2 قناة PCI Express Gen2 x16 عدد 1	الفتحات
منفذ محرك أقراص مرنة عدد 1 منفذ IDE عدد 1 منفذ SATA عدد 6 منفذ اللوحة الأملمية عدد 1 منفذ الصوت الأملي عدد 1 منفذ CD-IN عدد 1 منفذ خرج S/PDIF عدد 1 وصلة مروحة وحدة المعالجة المركزية عدد 1 وصلة مروحة النظام عدد 2 وصلة مسح CMOS عدد 1 منفذ USB عدد 3 منفذ تسلسلي عدد 1 منفذ توصيل الطاقة (24دبوس) عدد 1 منفذ توصيل الطاقة (4دبابيس) عدد 1	منفذ محرك أقراص مرنة عدد 1 منفذ IDE عدد 1 منفذ SATA عدد 6 منفذ اللوحة الأملمية عدد 1 منفذ الصوت الأملي عدد 1 منفذ CD-IN عدد 1 منفذ خرج S/PDIF عدد 1 وصلة مروحة وحدة المعالجة المركزية عدد 1 وصلة مروحة النظام عدد 2 وصلة مسح CMOS عدد 1 منفذ USB عدد 3 منفذ تسلسلي عدد 1 منفذ توصيل الطاقة (24دبوس) عدد 1 منفذ توصيل الطاقة (4دبابيس) عدد 1	المنافذ على سطح اللوحة
لوحة مفاتيح PS/2 عدد 1 مولس PS/2 عدد 1 منافذ VGA عدد 1 منافذ DVI-D عدد 1 منفذ شبكة اتصال محلية عدد 1 منافذ USB عدد 4 مقيس صوت عدد 3	لوحة مفاتيح PS/2 عدد 1 مولس PS/2 عدد 1 منافذ VGA عدد 1 منافذ DVI-D عدد 1 منفذ شبكة اتصال محلية عدد 1 منافذ SBU عدد 4 مقيس صوت عدد 3	منفذ دخل/خرج اللوحة الخلفية
233 مم (عرض) X 244 مم (ارتفاع)	233 مم (عرض) X 244 مم (ارتفاع)	حجم اللوحة
Windows XP / Vista / 7 بعضها في إضافة أو إزالة الدعم لأي نظام تشغيل بإخطار أو Biostar احتفظ بدون إخطار .	Windows XP / Vista / 7 بعضها في إضافة أو إزالة الدعم لأي نظام تشغيل بإخطار أو Biostar احتفظ بدون إخطار .	دعم أنظمة التشغيل

JAPANESE

	TA780GE/TA760GE/ TA785GE/TA785GE 128M	TA790GXE
CPU	Socket AM2+ AMD Athlon 64 / Athlon 64 FX / Athlon 64 X2 / Sempron / Phenom / Phenom II プロセッサ AMD 64アーキテクチャでは、32ビットと64ビット計算が可能です ハイパートランスポート3.0をサポートします	Socket AM2+ AMD Athlon 64 / Athlon 64 FX / Athlon 64 X2 / Sempron / Phenom / Phenom II プロセッサ AMD 64アーキテクチャでは、32ビットと64ビット計算が可能です ハイパートランスポート3.0をサポートします
FSB	5.2 GT/sのバンド幅までハイパートランスポート3.0をサポートします 4.4 GT/sのバンド幅までハイパートランスポート3.0をサポートします (TA785GE/TA785GE 128M)	5.2 GT/sのバンド幅までハイパートランスポート3.0をサポートします
チップセット	AMD 780G (TA780GE) AMD 760G (TA760GE) AMD 785G (TA785GE/TA785GE 128M) AMD SB710	AMD 790GX AMD SB750
メインメモリ	DDR2 DIMMスロット x 4 各DIMMは 256MB/512MB/1GB/2GB/4GB DDR2をサポート 最大メモリ容量 16GB デュアルチャンネルモードDDR2メモリモジュール DDR2 533 / 667 / 800をサポート DDR2 1066をサポート (by AM2+/AM3 CPU) 登録済みDIMMとECC DIMMはサポートされません	DDR2 DIMMスロット x 4 各DIMMは 256MB/512MB/1GB/2GB/4GB DDR2をサポート 最大メモリ容量 16GB デュアルチャンネルモードDDR2メモリモジュール DDR2 533 / 667 / 800をサポート DDR2 1066をサポート (by AM2+/AM3 CPU) 登録済みDIMMとECC DIMMはサポートされません
グラフィックス	780G (HD3200)/760G (HD3000)/785G(HD4200) Onboard side port memory 128MB DDR2 (TA785GE 128M Only) 最大の共有ビデオメモリは512MBです DX10/DVIのサポート Hybrid CrossFireX のサポート (by ATI driver)	790GX (HD3300) Onboard side port memory 128MB DDR2 最大の共有ビデオメモリは512MBです DX10/DVIのサポート Hybrid CrossFireX のサポート (by ATI driver)
Super I/O	ITE IT8718F もっとも一般に使用されるレガシーSuper I/O機能を採用しています。 低ピンカウントインターフェイス 環境コントロールイニシアチブ、 H/Wモニター ファン速度コントローラ/ モニター ITEの「スマートガーディアン」機能	ITE IT8718F もっとも一般に使用されるレガシーSuper I/O機能を採用しています。 低ピンカウントインターフェイス 環境コントロールイニシアチブ、 H/Wモニター ファン速度コントローラ/ モニター ITEの「スマートガーディアン」機能

TA780GE/TA760GE/TA785GE/TA785GE 128M/TA790GXE

	TA780GE/TA760GE/ TA785GE/TA785GE 128M		TA790GXE
IDE	AMD SB710 Ultra DMA 33 / 66 / 100 / 133バスマスタモード PIO Mode 0~4のサポート、		AMD SB750 Ultra DMA 33 / 66 / 100 / 133バスマスタモード PIO Mode 0~4のサポート、
SATA II	AMD SB710 最高3 Gb/秒のデータ転送速度 SATAバージョン2.0仕様に準拠。 RAID 0,1,1+0のサポート		AMD SB750 最高3 Gb/秒のデータ転送速度 SATAバージョン2.0仕様に準拠。 RAID 0,1,5,1+0のサポート
LAN	Realtek RTL 8111DL 10 / 100 / 1000 Mb/秒のオートネゴシエーション 半/全二重機能		Realtek RTL 8111DL 10 / 100 / 1000 Mb/秒のオートネゴシエーション 半/全二重機能
サウンド Codec	ALC662 ハイデフィニションオーディオのサポート 5.1 チャンネルオーディオアウト		ALC662 ハイデフィニションオーディオのサポート 5.1 チャンネルオーディオアウト
スロット	PCIスロット x2 PCI Express Gen2 x16スロット x1		PCIスロット x2 PCI Express Gen2 x16スロット x1
オンボードコ ネクタ	フロッピーコネクタ x1 IDEコネクタ x1 SATAコネクタ x6 フロントパネルコネクタ x1 フロントオーディオコネクタ x1 CDインコネクタ x1 S/PDIFアウトコネクタ x1 CPUファンヘッダ x1 システムファンヘッダ x2 CMOSクリアヘッダ x1 USBコネクタ x3 シリアルポート x1 電源コネクタ(24ピン) x1 電源コネクタ(4ピン) x1		フロッピーコネクタ x1 IDEコネクタ x1 SATAコネクタ x6 フロントパネルコネクタ x1 フロントオーディオコネクタ x1 CDインコネクタ x1 S/PDIFアウトコネクタ x1 CPUファンヘッダ x1 システムファンヘッダ x2 CMOSクリアヘッダ x1 USBコネクタ x3 シリアルポート x1 電源コネクタ(24ピン) x1 電源コネクタ(4ピン) x1
背面パネル I/O	PS/2キーボード x1 PS/2マウス x1 VGAポート x1 DVI-Dポート x1 LANポート x1 USBポート x4 オーディオジャック x3		PS/2キーボード x1 PS/2マウス x1 VGAポート x1 DVI-Dポート x1 LANポート x1 USBポート x4 オーディオジャック x3
ボードサイズ	233 mm (幅) X 244 mm (高さ)		233 mm (幅) X 244 mm (高さ)
OSサポート	Windows XP / Vista / 7 Biostarは事前のサポートなしにOSサポートを追加ま たは削除する権利を留保します。		Windows XP / Vista / 7 Biostarは事前のサポートなしにOSサポートを追加ま たは削除する権利を留保します。

2009/09/23