

Handling Precautions



CAUTION

High potential static charge can cause damage to the integrated circuits on the board. Before handling any mainboard outside of its protective packaging, ensure that there is no static electric charge on your body.

Danger of explosion if battery is incorrectly replaced. Replace only with the same or equivalent type recommended by the manufacturer.

- ◆ Keep the board in its anti-static bag until you are ready to install it.
- ◆ Protect your board from static electricity by well grounding of your body and the equipment during the installation, such as wearing a grounded wrist strap.
- ◆ Always handle the board by its edges.
- ◆ Do not touch with the components on the boards, add-on cards and modules, or the “gold finger” connectors going to be plugged into the expansion slot. It is best to handle system components by their mounting bracket.
- ◆ Ensure the system power is completely turn-off before doing any installation work.

Notice to Customers

The information contained in this User's Guide with no liability whatsoever, and disclaims any express or implied warranty, relating to sale and/or use of products including liability or warranties relating to fitness for a particular purpose, merchantability, or infringement of any patent, copyright or other intellectual property right. We shall not be liable for any loss or profits, loss of business, loss of use or data, interruption of business, or for indirect, special, incidental, or consequential damages arising from any defect or error in this User's Guide or product.

We retains the right to make changes on this User's Guide and product descriptions at any time, without notice.



Trademarks™

SIS is a registered trademark of Silicon Integrated Systems Corp.

Intel®, **Pentium®** are registered trademarks of Intel Corporation.

AMD®-K5, **AMD®-K6**, **AMD®-K6-2**, **AMD®-K6-III** are registered trademarks of Advanced Micro Devices, Inc.

Cyrix 6X86MX, **Cyrix MII** are registered trademarks of National Semiconductor Corporation.

IBM PC/AT, **PC-DOS**, **OS/2** and **OS/2 WARP** are registered trademarks of International Business Machines Corporation.

MS-DOS, **Windows 95**, **Windows 98**, are registered trademarks of Microsoft Corporation.

AWARD BIOS is a product of Award Software Inc.

Third-party brands and names mentioned in this User's Guide are the property of their respective owners.

User's Guide Revision : 1.00

Release Date : November 1999

Part No : 90-530BX1.00-00

Copyright © 1999, All rights reserved.



Table of Contents

FEATURES OF THE BOARD	4
OVERVIEW	4
FEATURES SUMMARY	4
MOTHERBOARD INSTALLATION	6
INSTALLATION PRECAUTIONS	6
A QUICK INTRODUCTION.....	6
CPU INSTALLATION	7
INSTALLING SYSTEM MEMORY (RAM)	8
EXPANSION CARDS INSTALLATION	9
CONNECTING EXTERNAL CONNECTOR.....	9
AT Power Connector	9
ATX Power Connector.....	10
Floppy Drive Connector.....	10
IDE Connectors	10
Front Panel Function Connectors	11
REPLACING BATTERY	12
QUICK INSTALLATION GUIDE	13
QUICK REFERENCE OF YOUR MOTHERBOARD.....	15
ULTRA DMA 66 DEVICE GUIDE	17
CPU JUMPER SETTINGS.....	18
AWARD BIOS SETUP.....	21
STANDARD CMOS SETUP.....	22
BIOS FEATURES SETUP	24
CHIPSET FEATURES SETUP	26
PCI/PnP CONFIGURATION SETUP	29
POWER MANAGEMENT SETUP	30
INTEGRATED PERIPHERAL SETUP	33
DRIVER INSTALLATION GUIDE	35



Features of the Board

Overview

Congratulations on purchasing the highest performance motherboard. With the advanced technology available today, this motherboard is designed to run Pentium[®] , AMD[®] and Cyrix[®] processors. The on-board system memory consists of DIMM. In addition, two unbuffered, 3.3 Volts, 168-pin SDRAM sockets are also included for 16 to 256MB synchronous Dynamic memory support. A 321-pins , Zero Insertion Force (ZIF) socket allows an easy upgrade path for the future processors.

The motherboard uses SIS 530 chipset. The SIS 530 PCI/ISA Bridge provides an integrated Bus Mastering IDE controller with two high performance UltraDMA-66 IDE interfaces for up to four IDE devices (such as hard drives or CD-ROM). The PCI/ISA Bridge also including an USB interface. The integrated I/O controller integrates the standard PC I/O functions: floppy interface, two FIFO serial ports, one EPP/ECP capable parallel port, and support for an IrDA and Consumer Infra Red compatible interface.

On-board 32-bit PCI local bus slots allow a higher bandwidth data path, which serves as a super highway for intensive data-movement such as video or networking. The BIOS support PCI bridge user configuration, which allows further expansion of the system with PCI peripherals. Up to two 16-bit ISA slots are provided so that the board is backward hardware compatible with the older expansion card. A total of five expansion slots can be populated with add-in cards as one PCI and ISA slots share the same chassis I/O panel.

Features Summary

This motherboard comes with following features:

- Support Intel Pentium/Pentium-MMX, AMD K5/K6, Cyrix/IBM 6x86/6x86MX/M-II, IDT-C6
- Support AMD-K6-2, AMD-K6-3 and Cyrix M-II Processors with 100MHz Front-side Bus
- SiS 530 Chipset
- Three DIMM slots Supporting up to 1.5GB Memory Capacity
- Support 100MHz PC100 SDRAM DIMM
- 3 x PCI slots, 2 x ISA slots
- 2 x USB ports, 1 x PS/2 mouse port, 1 x IrDA port
- 1 x FDD port, 1 x LPT port, 2 x COM ports
- Dual IDE Channels Supporting Four Ultra-DMA33/66 IDE Devices
- WAKEUP-LINK Header to Support Intel Wake-On-LAN
- AGP Graphics Controller Integrated inside SiS 530 Chipset
- 100MHz, 64-bit Super-AGP Architecture
- Hardware Accelerated MPEG-I/II and DVD Playback
- Dynamic Graphics Memory Allocation on System Memory

-
- 
- Full Support for Microsoft Direct 3D and Direct Draw
 - Award BIOS, PC98/ACPI/DMI Compliant
 - Dual AT/ATX Power Supply Interface



Motherboard Installation

INSTALLATION PRECAUTIONS

During installation and initial test, use caution to avoid personal injury and damage to wiring due to sharp pins on connectors and printed circuit assemblies, rough chassis edges and corners, and hot components. Adhere to warnings and limitations regarding accessibility into areas designated only for authorized technical personnel.

A QUICK INTRODUCTION

To install and operate your the new motherboard, you must follow the steps below:

1. Install the CPU with cooling fan
2. Install RAM modules
3. Connect cables, wires and power connector
4. Install expansion cards

CPU Installation

The motherboard provides a 321-pins, type-7, ZIP socket. The CPU should have a fan attached to it to prevent overheating. If this is not the case then purchase a fan before you turn-on the system.

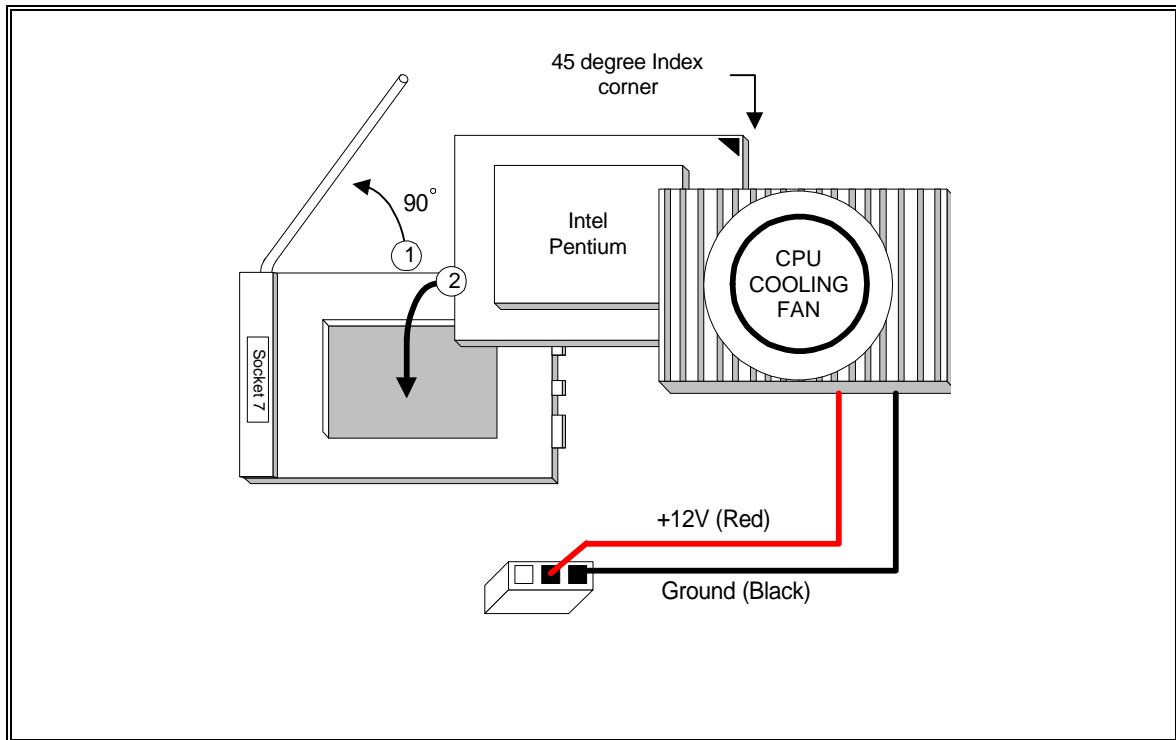

CPU Installation Diagram



CAUTION

Without an effective cooling fan, the CPU can overheat and cause damage to both the CPU and the motherboard.

INSTALLING SYSTEM MEMORY (RAM)

The motherboard supports two 168-pin DIMM.

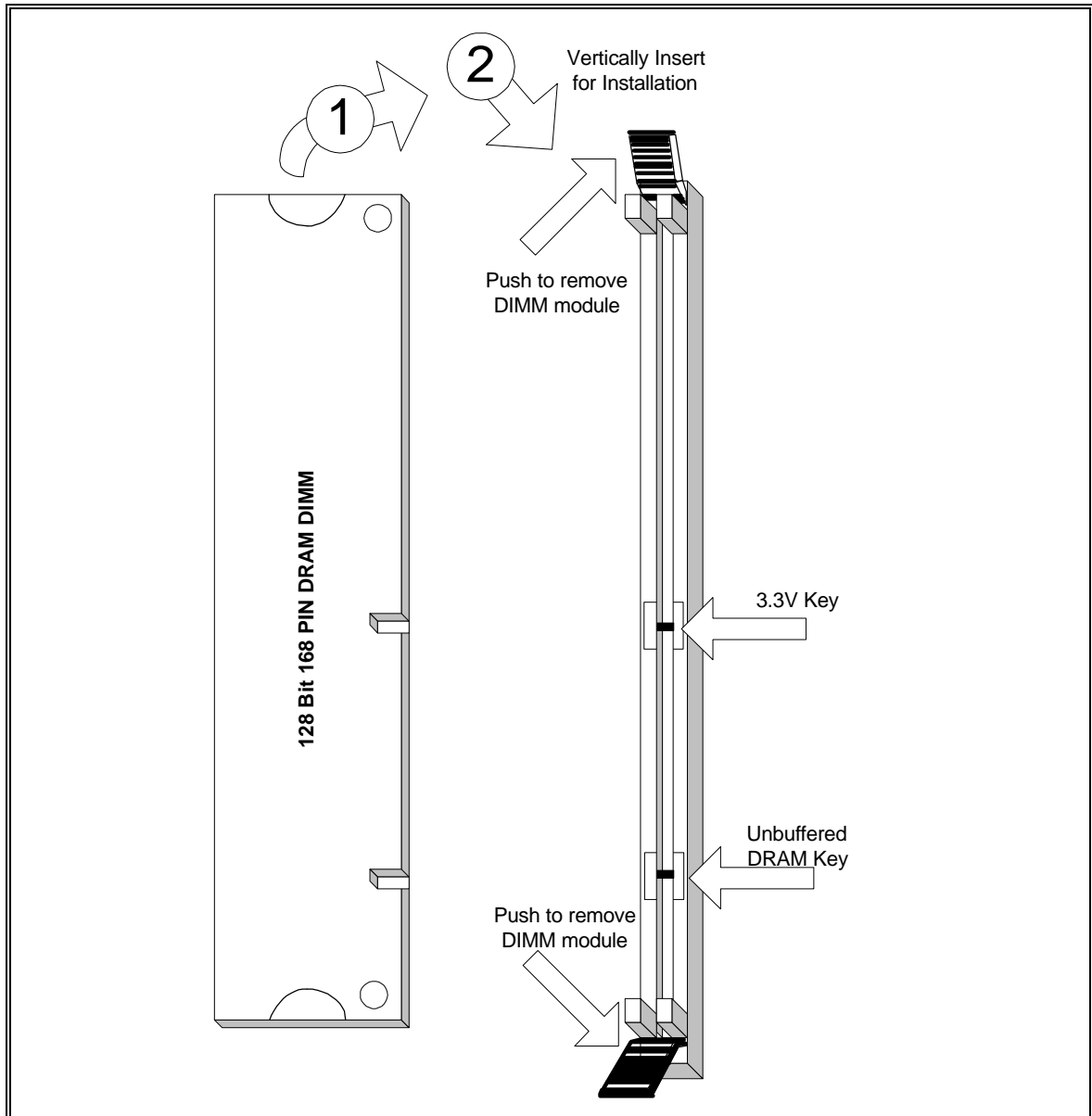

168-Pin SDRAM Module Installation Diagram

EXPANSION CARDS INSTALLATION

At the most of beginning, you must read your expansion card documentation on any hardware and software settings that may be required. The installation procedures are summarized as below:

1. Read the User's Guide/Manual of your expansion card.
2. If necessary, set any jumpers on your expansion card.
3. Power-off the system and then disconnected the power cord.
4. Remove your computer's cover.
5. Remove the metal bracket from one of the empty slot, ISA or PCI, corresponding to the type of expansion card.
6. Carefully align the card's connectors and press firmly, make sure that the connection is good.
7. Secure the card on the slot.
8. Replace the computer's cover.
9. Setup the BIOS configuration if necessary.
10. Install the required software drivers for your expansion card.

CAUTION

Before adding or removing any expansion card or other system components, make sure that you unplug your system power supply. Failure to do so may cause damage of your motherboard and expansion cards.

CONNECTING EXTERNAL CONNECTOR

AT Power Supply Connector

A 12-Pin power supply provides two plugs incorporates standard $\pm 5V$ and $\pm 12V$, each containing six wires, two of which are black. Orient the connectors so that the black wires are together.

Pin	Signal Name	Pin	Signal Name
1	Power Good Signal	7	Ground
2	+5V	8	Ground
3	+12V	9	-5V
4	-12V	10	+5V
5	Ground	11	+5V
6	Ground	12	+5V

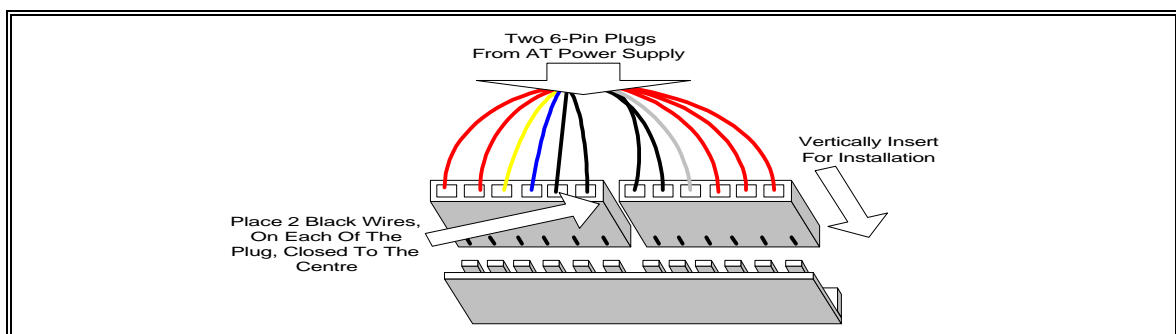

AT Power Connector Installation

ATX Power Supply Connector

A single 20-pin connector incorporates standard $\pm 5V$ and $\pm 12V$, optional 3.3V and soft-power signals. With a power supply supports remote power on/off, the motherboard can turn off the system power through software control, such as the shutdown in Windows 98 Start menu. The system BIOS will turn the system power off when it receives the proper APM command from the OS. APM must be enabled in the system BIOS and OS in order for the soft-off feature to work correctly.

Pin	Signal Name	Pin	Signal Name
1	+3.3V	11	+3.3V
2	+3.3V	12	-12V
3	Ground	13	Ground
4	+5V	14	PW_ON
5	Ground	15	Ground
6	+5V	16	Ground
7	Ground	17	Ground
8	PWRGOOD	18	-5V
9	+5VSB	19	+5V
10	+12V	20	+5V

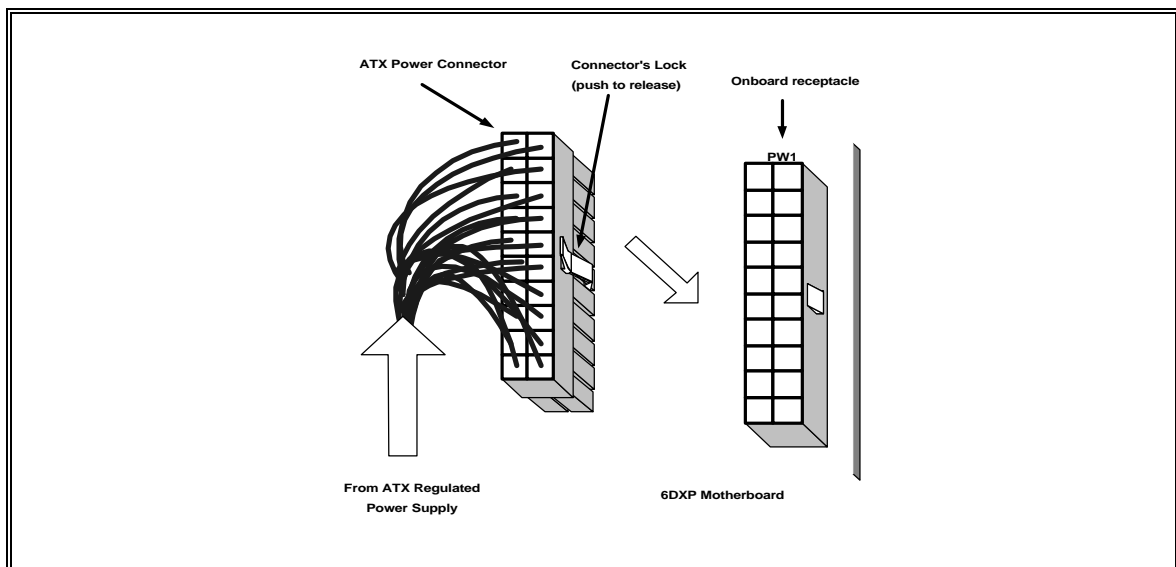

ATX Power Connector Installation

Floppy Drive Connector

This 34-pin connector supports the provided floppy drive ribbon cable. After connecting the single end to the on-board "FLOPPY" connector, connect the remaining plugs on the other end to the floppy drives correspondingly.

IDE Connectors

The two on-board IDE connectors support the provided 40-pin IDE hard disk ribbon cable. After connecting the single end to the board, connect the two remaining plugs at the other end of your hard disk(s). If you install two hard disks, you must configure the two drives by setting its jumpers according to the documentation of your hard disk. Also, you may connect the two hard disks to be both Masters using one ribbon cable on the primary IDE connector and one on the secondary IDE connector.

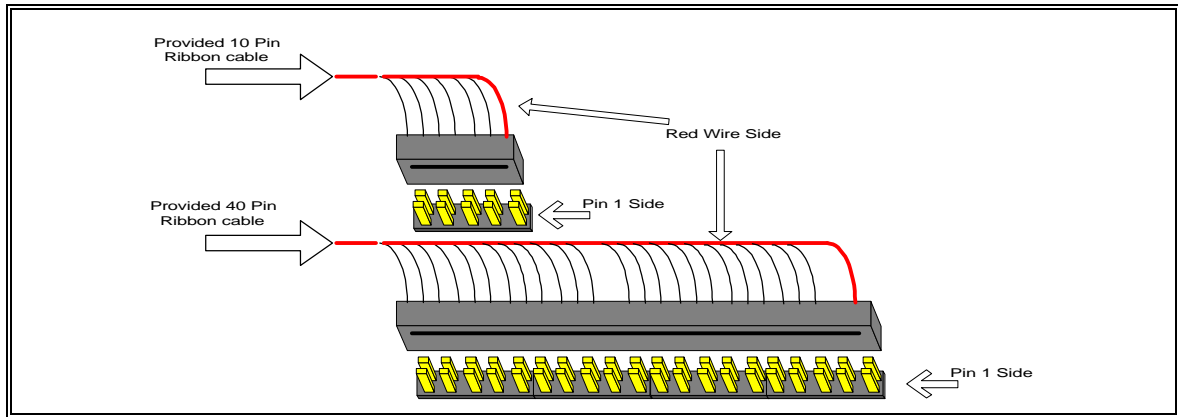

Ribbon cable Installation Example

NOTICE

For the flat ribbon cable connection, please make sure that the pin 1 of the ribbon cable (the red wire side of the cable) is correctly connected to the on-board connector's pin 1 as shown on the "Map of the Motherboard".

Front Panel Function Connectors

All the front panel indicator, speaker, and switch functions are grouped into an on-board 26-pin connector

Front panel features supported include:

- System Reset, RESET
- Power LED, form KEYLOCK
- Hard Drive activity LED, IDE LED
- System Speaker, SPEAKER
- Soft-touch button power on/off, SW ON
- External power saving control, EXTSMI (optional)

The connector pin out are described as the figure below:

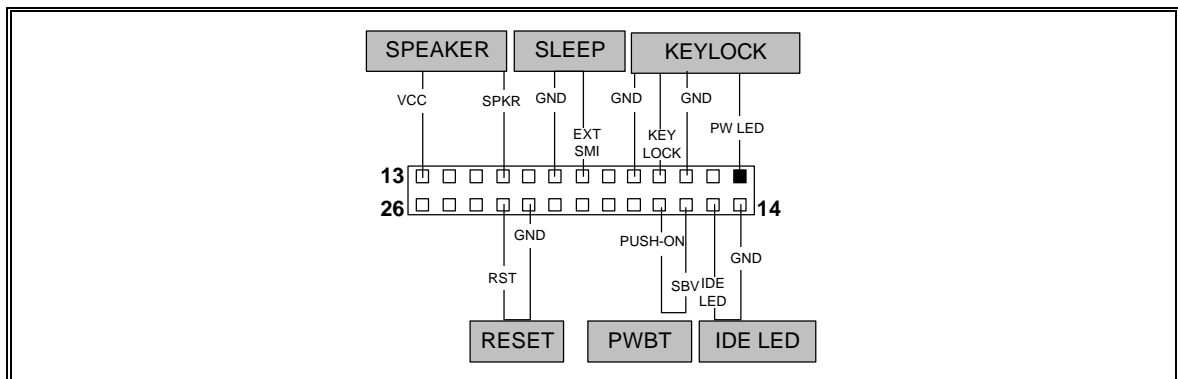

The Onboard Function Connector Pin Out

Integrated USB, Infra-Red and PS/2 Mouse connector

The total of two USB device connectors, a PS/2 mouse, and Infrared devices are all allocated at this connector

- Pin1 to Pin5 for USB1 connector
- Pin11 to Pin15 for USB2 connector
- Pin6 to Pin10 for PS/2 connector
- Pin16 to Pin20 InfraRed connector

The connector pin out signal definitions are described as the table below:

Pin	Signal Name	Pin	Signal Name
1 (USB1)	USB +5 Volt	11 (USB2)	USB +5 Volt
2	USB Port 1-	12	USB Port 2-
3	USB Port 1+	13	USB Port 2+
4	Ground	14	Ground
5	No Connect	15	No Connect
6 (PS/2 Mouse)	PS/2 Data	16 (IR)	+5V
7	PS/2 Clock	17	No Connect
8	Ground	18	Infrared Receive
9	No Connect	19	Ground
10	+5V	20	Infrared Transmit

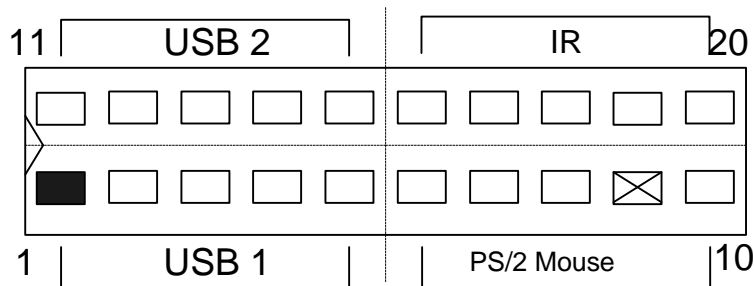

VGA connector

Install the VGA connector VGA for the onboard VGA..

REPLACING BATTERY

A 3V, CR-2030, Lithium battery is installed on the on-board battery socket. This battery is used to supply the CMOS RAM backup power during system powered-off. Danger of explosion if battery is incorrectly replaced. Therefore, if you have any difficulties, please consult to the technical personnel.

T530B-S Quick Installation Guide

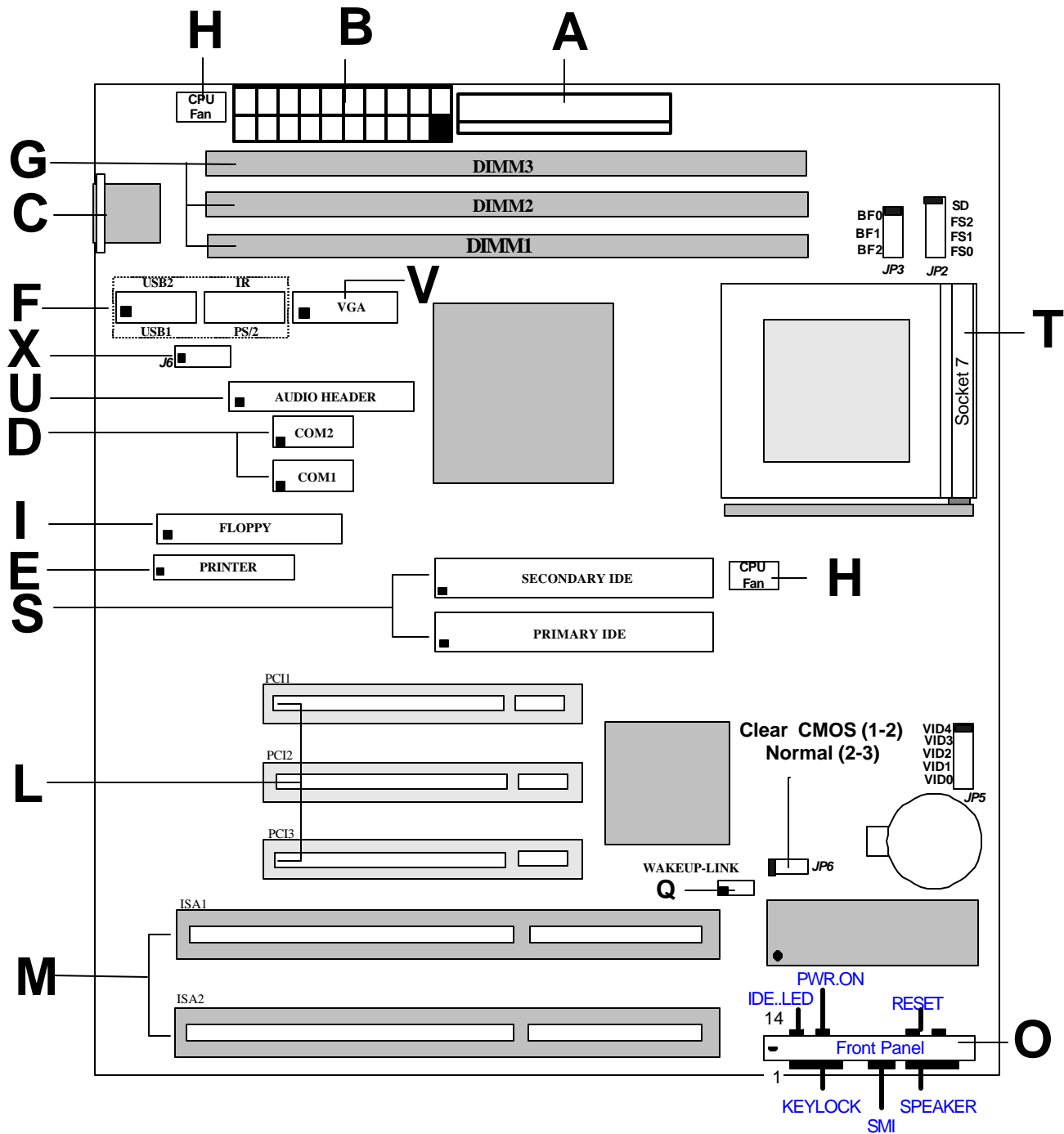

T530B-S

- A. AT Power Supply Connector
- B. ATX Power Supply Connector
- C. AT Keyboard Connector
- D. Serial (COM1 and 2) Headers
- E. Parallel (Printer) Port Header
- F. Integrated Functions Connector
- G. 3.3v DIMM Sockets
- H. CPU Fan Connector
- I. Floppy Drive Connector
- X J6 is CD Audio Input(1,3:Ground,2:Right,4:Left)
- V. VGA Connector
- L. PCI Bus Connectors
- M. ISA Bus Connectors
- O. Front Panel Connector
- Q. WAKEUP-LINK Header
- S. IDE Connectors
- T. Socket 7
- U. Audio Header
 - : Line Input
 - : Microphone Input
 - : Line Output
 - : Joystick

Audio Connector

All the Line-In, MIC In, Line-Out and MIDI/JOYSTICK for the On-Board Sound are located here.

Audio CD Connectors

The Audio CD input connector for the On-Board Sound.

SDRAM Installation Sequence

Install SDRAM into the DIMM Slot must according to the following sequence.

- 1. DIMM1 Slot (Must Install First)**
- 2. DIMM2 Slot**
- 3. DIMM3 Slot**

On Board Crystal 3D Audio

In BIOS "Integrated Peripherals", set this option to enable the On Board Crystal 3D Audio

Sound Driver Location

- Win95/98 Driver** - CD drive Letter : \ Crystal \ CS423x \ Win95 \
- WinNT 4.0 Driver** - CD drive Letter : \ Crystal \ CS423x \ NT40 \
- WDM Driver** - CD drive Letter : \ Crystal \ Wdm \
- Wavetable Synthesizer** - CD drive Letter : \ Crystal \ Softsynh \
- Voyetra Software** - CD drive Letter : \ Crystal \ Voyetra \

Quick Reference of Your Motherboard

[A] AT Power Supply Connector

Based on the AT specification, one 12-pin power connector covers all the required power sources, $\pm 5V$ and $\pm 12V$.

[B] ATX Power Supply Connector

Based on the ATX specifications, one 20-pin power connector covers all the required power sources, $\pm 5V$, $\pm 12V$, and $\pm 3.3V$, with soft-touch button power on/off features. This connector reduces the installation time and minimizes the chance of defects caused by incorrect connection.

[C] AT Keyboard Connector

This connection is used for a standard IBM-compatible keyboard, such as 101 enhanced keyboard.

[D] Serial (COM 1 and 2) Port Headers

This motherboard provides two high-speed UART compatible serial ports.

[E] Parallel (Printer) Port Connector

One Parallel port with SPP, EPP and ECP capabilities.

[F] Integrated Functions Connector

- I) From Pin1 to Pin5 is the first USB device “USB1” and Pin11 to Pin15 is the second USB device “USB2” connector. Universal Serial Bus (USB) is new interface standard for any I/O device “Outside the Box”. USB makes your peripherals have a real plug and play (PnP) capabilities with up to 12MB/sec data speed. In the coming soon, any external device connected to your computer will be standardized into USB standard which are all have a special 4-pin rectangle shape connector. Therefore, with the chipset, this motherboard builds two USB headers on-board for you future investment. If you are using an USB device, you must purchase an optional USB connector.
- II) From Pin6-10 is the PS/2 device, like some PS/2 keyboard and mouse, are all have a standard 6-pin round shape connector. However, it does not have a unique onboard standard. Therefore, please refer to the Chapter “Motherboard Installation”, in order to purchase a suitable PS/2 Mouse Connector.
- III) From Pin16-20 is a 5-pin interface on the front panel I/O connector is provided to allow connection to a Hewlett Packard HSDSL-1000 compatible Infra-red (IrDA) transmitter/receiver. Once the module is connected to the front panel I/O header, Serial port 2 can be re-directed to the IrDA module. When configured for IrDA, the user can transfer files to or from portable devices such as laptops, PDA's and printers using application software such as LapLink. The IrDA specification provides for data transfers at 115kbps from a distance of 1 meter. Support for Consumer Infra Red (ASK-IR) is also included, please refer to your IR equipment for more detailed information.

[G] SDRAM Sockets

There are three unbuffered, 3.3 Volts, SDRAM socket on-board provides more flexibility for your system memory upgrade.

[H] CPU FAN CONNECTOR

A 3-pin CPU fan connector.



[I] Floppy Drive Connector

A 34-pin connector on-board allows connection to two 360K, 720K, 1.2M, 1.44, 2.88M floppy disk drives.

[L] PCI Add-in Board Connectors

This motherboard provides full-length 32-bits PCI slots with up to 133MB/sec burst data transfer rate.

[M] ISA Add-in Board Connectors

This motherboard provides 16-bits ISA slots which allows backward hardware compatibility.

[O] Front Panel Function Connector

For your convenience, all the front panel functions are integrated into a single connector, which included power LED and keyboard lock, turbo switch, reset switch, SMI switch and speaker.

[Q] WAKEUP-LINK Interface

This header is used to connect an add-in NIC (Network Interface Card) which has WOL capability to a motherboard.

[S] IDE Connectors

This motherboard has two independent high performance bus-mastering PCI IDE interfaces capable of supporting up to UltraDMA-66 devices. The system BIOS supports automatic detection of the IDE device data transfer rate and translation between different kinds of device mode such as Logical Block Addressing (LBA) and Extended Cylinder Sector Head (ECSH) translation modes and ATAPI (e.g., CD-ROM) devices on both IDE interfaces.

In a true multi-tasking operating systems like Windows[®] 98, the IDE interface can operate as a PCI bus master capable of supporting Ultra DMA-66 devices with transfer rates of up to 66MB/sec.

[T] Pentium[®] Type-7 Socket

The type-7 socket is a 321-pins, zero insertion force (ZIF) socket. It provides users with a performance upgrade path to Pentium[®] OverDrive technology.

[V] VGA Connector



PENTIUM[®] PROCESSOR

An approved Pentium heatsink is necessary for proper thermal dissipation in an AT compliant chassis. The processor/heatsink assembly must be securely fastened to the Socket 7 ZIF socket by two clips. These clips fit over the heatsink assembly and attach to the outer wide tabs of the Socket 7 assembly.

Ultra DMA 66 Device Guide

For the best I/O transfer rate, we recommend you connecting your Ultra ATA/66 and Ultra ATA/33 Devices according to the following configuration :

Primary IDE - Connect Ultra ATA/66 device with Ultra ATA/66 cable (Optional)

- Attach the blue connector to mainboard IDE 1.
- Attach the black connector to master drive e.g. Ultra ATA/66 Hard Disk
- Attach the grey connector to slave drive e.g. Ultra ATA/66 CD-Rom

Secondary IDE -Connect Non-Ultra ATA/66 device with regular IDE cable

- Attach the devices to mainboard IDE 2 .
- Attach the master cable connector to master drive
e.g. Ultra ATA/33 Hard Disk
- Attach the slave cable connector to slave drive

e.g. Ultra ATA/33 CD-Rom

Ultra ATA Specification :

Ultra ATA/66 - cycle time : 30ns

- maximum transfer rate : 66MB/sec
- Ultra ATA/33 - cycle time : 60ns

maximum transfer rate : 33MB/sec

CPU Jumper Settings

Please set the jumper manually according to the CPU's marking before boot up the system. Using the following tables to set the suitable **CPU Core, External Bus Speed & Bus Frequency Ratio**.

1. Set the CPU Core Voltage

CPU Voltage Selection List

CPU type	Voltage Requirements
Intel Pentium P54C, Cyrix/IBM M1 6x86, AMD-K5, IDT-C6	3.4V (STD) / 3.5V (VRE)
Intel Pentium P55C, Cyrix/IBM M1 6x86L	2.8V
Cyrix/IBM 6x86MX, MII, K6-PR166/200	2.9V
AMD K6/233	3.2V
AMD K6 - 233,266,300 AMD K6-2 - 266,300,333,350,366,380,400,450,475,500,550 AMD K6-III - 400,450,475,500,550	2.2V
AMD K6-2 - 450,475 AMD K6-III - 400,450	2.4V

CPU Voltage Setting Table

Vcore	VID4	VID3	VID2	VID1	VID0
1.8V	Close	Close	Open	Close	Open
2.0V	Close	Close	Close	Close	Open
2.2V	Open	Open	Open	Close	Open
2.4V	Open	Open	Close	Open	Open
2.5V	Open	Open	Close	Open	Close
2.8V	Open	Close	Open	Open	Open
2.9V	Open	Close	Open	Open	Close
3.1V	Open	Close	Open	Close	Close
3.2V	Open	Close	Close	Open	Open
3.3V	Open	Close	Close	Open	Close
3.5V	Open	Close	Close	Close	Close

2. Set the External Bus Speed (MHz) and Bus Frequency Ratio

CPU TYPE	Freq.	Ratio	Bus F.	SD	FS2	FS1	FS0	BF0	BF1	BF2
AMD-K6-III/550	550MHz	5.5x	100MHz	Open	Open	Close	Close	Open	Open	Close
AMD-K6-III/500	500MHz	5.0x	100MHz	Open	Open	Close	Close	Open	Close	Close
AMD-K6-III/475	475MHz	5.0x	95MHz	Open	Close	Open	Open	Open	Close	Close
AMD-K6-III/450	450MHz	4.5x	100MHz	Open	Open	Close	Close	Close	Close	Close
AMD-K6-III/400	400MHz	4.0x	100MHz	Open	Open	Close	Close	Close	Open	Close
AMD-K6-2/500	500MHz	5.0x	100MHz	Open	Open	Close	Close	Open	Close	Close
AMD-K6-2/475	475MHz	5.0x	95MHz	Open	Close	Open	Open	Open	Close	Close
AMD-K6-2/450	450MHz	4.5x	100MHz	Open	Open	Close	Close	Close	Close	Close
AMD-K6-2/400	400MHz	4.0x	100MHz	Open	Open	Close	Close	Close	Open	Close
AMD-K6-2/380	380MHz	4.0x	95MHz	Open	Close	Open	Open	Close	Open	Close
AMD-K6-2/366	366MHz	5.5x	66MHz	Open	Close	Close	Close	Open	Open	Close
AMD-K6-2/350	350MHz	3.5x	100MHz	Open	Open	Close	Close	Open	Open	Open
AMD-K6-2/333	333MHz	3.5x	95MHz	Open	Close	Open	Open	Open	Open	Open
AMD-K6-2/300	300MHz	3.0x	100MHz	Open	Open	Close	Close	Open	Close	Open
AMD-K6-2/266	266MHz	4.0x	66MHz	Open	Close	Close	Close	Close	Open	Close
AMD-K6/300	300MHz	4.5x	66MHz	Open	Close	Close	Close	Close	Close	Close
AMD-K6/266	266MHz	4.0x	66MHz	Open	Close	Close	Close	Close	Open	Close
AMD-K6/233	233MHz	3.5x	66MHz	Open	Close	Close	Close	Open	Open	Open
AMD-K6/200	200MHz	3.0x	66MHz	Open	Close	Close	Close	Open	Close	Open
AMD-K6/166	166MHz	2.5x	66MHz	Open	Close	Close	Close	Close	Close	Open
AMD-K5/133	100MHz	1.5x	66MHz	Open	Close	Close	Close	Open	Open	Open
AMD-K5/100	100MHz	1.5x	66MHz	Open	Close	Close	Close	Open	Open	Open
Intel Pentium P54C	166MHz	2.5x	66MHz	Open	Close	Close	Close	Close	Close	Open
Intel Pentium P54C	133MHz	2.0x	66MHz	Open	Close	Close	Close	Close	Open	Open
Intel Pentium P54C	100MHz	1.5x	66MHz	Open	Close	Close	Close	Open	Open	Open
Intel Pentium P55C	233MHz	3.5x	66MHz	Open	Close	Close	Close	Open	Open	Open
Intel Pentium P55C	200MHz	3.0x	66MHz	Open	Close	Close	Close	Open	Close	Open
Intel Pentium P55C	166MHz	2.5x	66MHz	Open	Close	Close	Close	Close	Close	Open
IBM/Cryix M II-PR366	366MHz	2.5x	100MHz	Open	Open	Close	Close	Close	Close	Open
IBM/Cryix M II-PR333	333MHz	3.0x	83MHz	Open	Close	Open	Close	Open	Close	Open
IBM/Cryix M II-PR300	300MHz	3.0x	75MHz	Open	Close	Close	Open	Open	Close	Open
IBM/Cryix M II-PR300	300MHz	3.5x	66MHz	Open	Close	Close	Close	Open	Open	Open
IBM/Cryix 6x86MX-PR 233	200MHz	3.0x	66MHz	Open	Close	Close	Close	Open	Close	Open
IBM/Cryix 6x86MX-PR 200	166MHz	2.5x	66MHz	Open	Close	Close	Close	Close	Close	Open
IBM/Cryix 6x86 PR166+	133MHz	2.0x	66MHz	Open	Close	Close	Close	Close	Open	Open
IBM/Cryix 6x86L PR166	133MHz	2.0x	66MHz	Open	Close	Close	Close	Close	Open	Open

All CPU / SDRAM / PCI Frequency Setting Table

SD	FS2	FS1	FS0	CPU	SDRAM	PCI
Open	Close	Close	Close	66.8	66.8	33.4
Open	Close	Close	Open	75	75	30
Open	Close	Open	Close	83.3	83.3	33.3
Open	Close	Open	Open	95	95	31.7
Open	Open	Close	Close	100	100	33.3
Open	Open	Close	Open	112	112	37.3
Open	Open	Open	Close	124	124	41.3
Open	Open	Open	Open	133.3	133.3	33.3

SD	FS2	FS1	FS0	CPU	SDRAM	PCI
Close	Close	Close	Close	66.8	89	33.4
Close	Close	Close	Open	83.3	66.8	33.4
Close	Close	Open	Close	95	76	31.7
Close	Close	Open	Open	100	66.6	33.3
Close	Open	Close	Close	100	75	33.3
Close	Open	Close	Open	112	84	37.3
Close	Open	Open	Close	124	93	41.3
Close	Open	Open	Open	103	103	34.3

Bus Frequency Ratio Setting Table

Ratio	BF0	BF1	BF2
1.5X / 3.5X	Open	Open	Open
2.0X	Close	Open	Open
2.5X	Close	Close	Open
3.0X	Open	Close	Open
4.0X	Close	Open	Close
4.5X	Close	Close	Close
5.0X	Open	Close	Close
5.5X	Open	Open	Close

Clear CMOS

Set the Jumper [1-2] to clear CMOS.

Remember : Please set it back to normal [2-3] after clear CMOS.

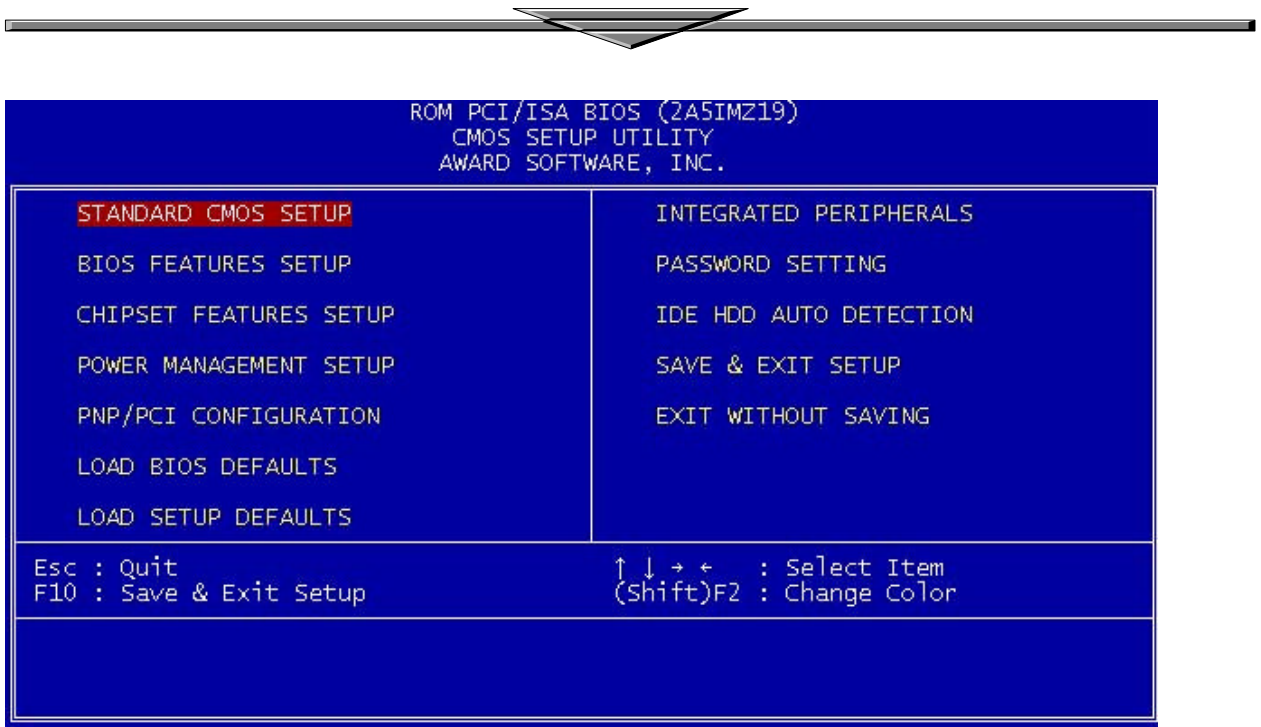

Award BIOS Setup

Standard CMOS Setup	Sets time, date, hard disk type, types of floppy drive. Monitor type, and if keyboard is installed.
Bios Features Setup	Sets Typematic Rate and Delay, Above 1 MB Memory Test, Memory Test Tick Sound, Hit Message Display, System Boot Up Sequence, and many others.
Chipset Features Setup	Sets chipset-specific options and features.
Power Management Setup	Controls power conservation options.
PCI/PnP Configuration	Sets options related to PCI bus and Plug and Play options.
Integrated Peripheral Setup	Controls I/O Controller- related options.
Load BIOS Defaults settings	This function is for user to load the BIOS default
Load SETUP Defaults	This function is for user to load the SETUP default settings.
Password Setting	The password setting allows you to limit the user access to the system and Setup.
IDE HDD Auto Detection	Automatically configure hard disk parameters.

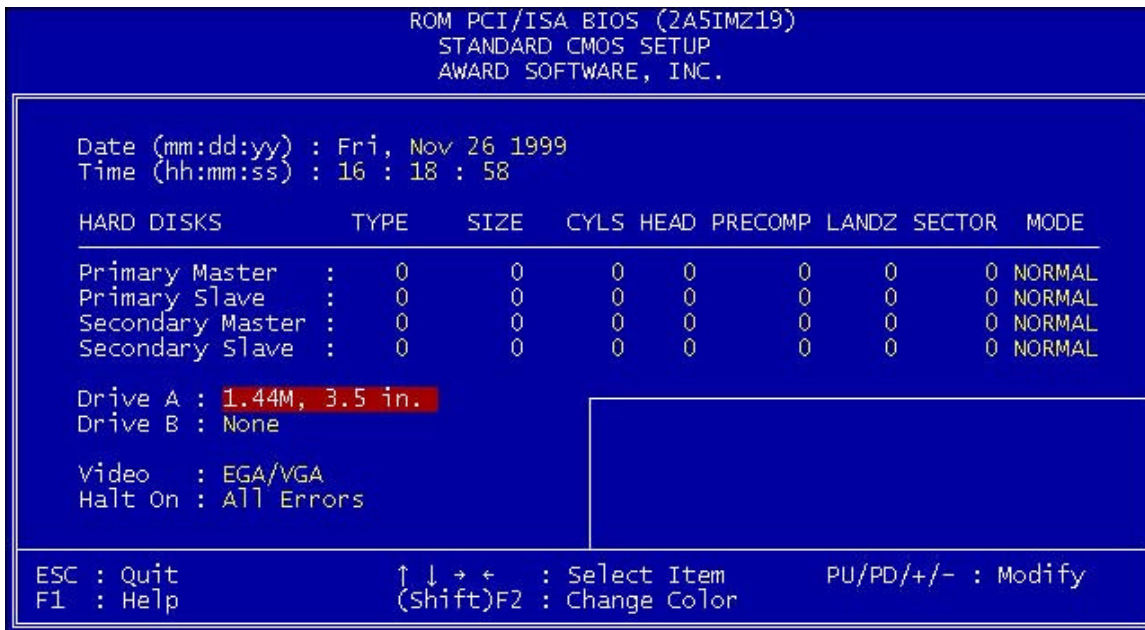

Standard CMOS Setup

Select the Award BIOS Setup options by choosing Standard Setup from the Award BIOS. Setup main menu. The Standard CMOS Setup options are described below.

Floppy Drive A: and B:

Move the cursor to these fields and select the floppy type. The settings are 360 KB 5 1/4 inch, 1.2 MB 5 1/4 inch, 720 KB 3 1/2 inch or 2.88 MB 3 1/2 inch.

Primary Master

Primary Slave

Secondary Master

Secondary Slave

Select these options to configure the drive named in the option. Select Auto Detect IDE to let BIOS automatically configure the drive. A screen with a list of drive parameters appears. Click on OK to configure the drive.

TYPE

How to Configure

IDE

Select Type. Select Auto to let BIOS determine the parameters. Click on OK when BIOS displays the drive parameters. Select LBA Mode. Select On if the drive has a capacity greater than 540 MB. Select Block Mode. Select On to allow block mode data transfers. Select 32-Bit Mode. Select On to allow 32-bit data transfers. Select the PIO Mode. It is best to select Auto to allow BIOS to determine the PIO mode. If you select a PIO mode that is not supported by the IDE drive. The drive will not work properly. If you are absolutely certain that you know the drive's PIO mode. Select PIO mode 0-4, as appropriate.

Standard MFM

Select Type. You must know the drive parameters. Select the drive type that exactly matches your drive's parameters.

Non-Standard MFM

Select Type. If the drive parameters do not match the drive parameters listed for drive types 1 - 46. Select User and enter the correct hard disk drive parameters.

ENTERING DRIVE PARAMETERS

Parameter

Description

Type

The number for a drive with certain identification parameters.

Cylinders

The number of cylinders in the disk drive.

Heads

The number of heads.

Precompensation

The actual physical size of a sector gets progressively smaller as the track diameter diminishes. Yet each sector must still hold 512 bytes. Write precompensation circuitry on the hard disk compensates for the physical difference in sector size by boosting the write current for sectors on inner tracks.

Landing Zone

This parameter is the track number on the disk surface where write precompensation begins.

Sectors

This number is the cylinder location where the heads normally park when the system is shut down. The number is the cylinder location where the heads normally park when the system is shut down. The formatted capacity of the drive is the number of heads times the number of cylinders times the number of sectors per track times 512 (bytes per sector).

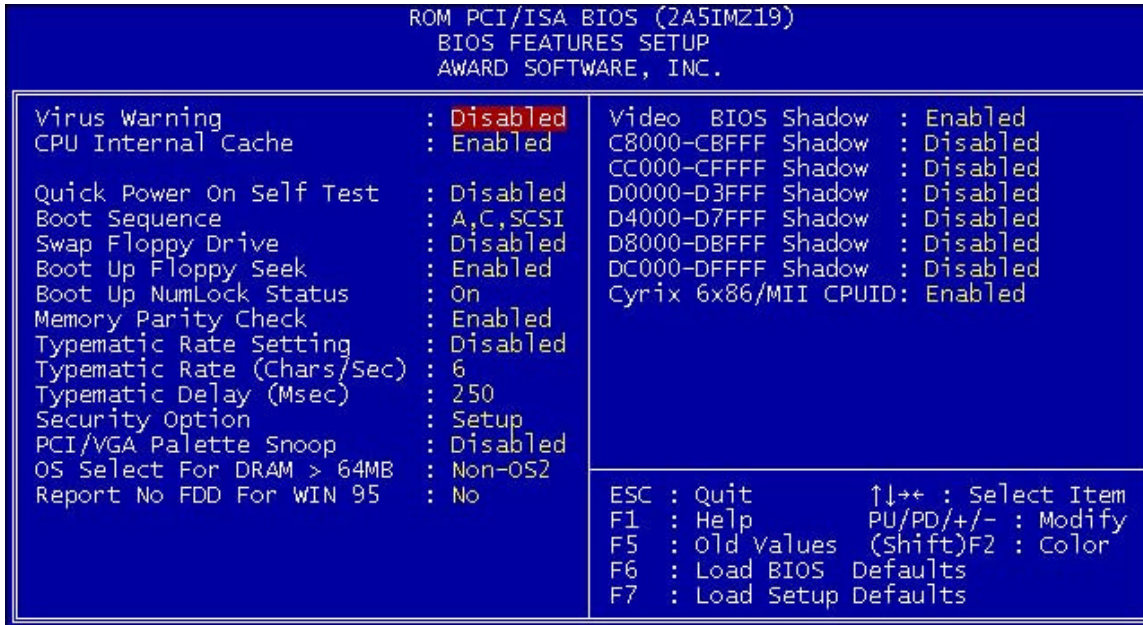

BIOS Features Setup

Virus Warning

You can "Enable" or "Disable" this feature. When enabled, it will activate automatically if anything attempt to access the boot sector or hard disk partition table during system boot-up. The default value is "Disabled".

CPU Internal Cache

This category enables or disables the internal cache to speed up memory access. The default value is "Enabled".

Quick Power On Self Test

This category speeds up Power On Self Test (POST) after you power on the computer. If it is set to "Enabled", BIOS will shorten or skip some check items during POST. The default value is "Disabled".

Boot Sequence

This category determines which drive computer searches first for the disk operating system (i.e., DOS). The default setting is "A,C,SCSI", means that the system will determine the drive A before drive C.

Swap Floppy Drive

This feature allows you to enable the system swap floppy function, the default is "Disabled". When this function enables, the system will assign the Drive A as Drive B, and vice versa.

Boot Up Floppy Seek

The default setting is "Enabled", so that the BIOS will search for floppy disk drive to determine if it is 40 or 80 tracks. If disabled, BIOS will not search for the type of floppy disk drive by track number. Note that there will be no warning message if the drive installed is 360K.

Boot Up NumLock Status

It determine the Num-Lock is turned on/off Num Lock. when the system is powered on so that the end user can use the arrow keys on both the numeric keypad and the keyboard. The default value is "On".

Memory Parity Check

It enables the memory parity checking. The setting are "enable" or "disable".

Typematic Rate Setting

Typematic Rate sets the rate at which characters on the screen at which characters on the screen repeat. The default setting is Disabled.

Typematic Rate (Chars/Sec)

Typematic rate sets the rate at which characters on the screen repeat when a key is pressed and held down. You can select 6-30 characters per second. The default setting is "6".

Typematic Delay (M sec)

When holding down a key, the time between the first and second character display. you specified numbers of times of character repeat on the screen. The default setting is "250".

Security Option

This category allows you to limit access to the system and Setup or just to Setup. When you select system, the system will not boot and access to Setup will be denied if the correct password is not entered at the prompt. If you select Setup, the system will boot but access to Setup will be denied if the correct password is not entered at the prompt. The default setting is "Setup".

PCI/VGA Palette Snoop

This option controls the system to access the PCI VGA card palette register. In general, this option is "Disabled". However, you may need to enable this option for some VGA cards which have incorrect color displayed on some software application.

OS Select For DRAM > 64MB

Some the OS/2 application access the memory in different mode. Enable this option to allow the system use another mode to access the main memory for OS/2 applications.

Report No Floppy Disk For Windows 95

The system will report floppy disk status to Windows95 if setting is Yes.

VIDEO BIOS Shadow

The system BIOS is automatically shadowed. The default setting for the "Video BIOS Shadow" is "Enabled". It determines whether video BIOS will be copied to RAM. However, it is optional from chipset design. Video Shadow will increase the video speed.

C8000 - CFFFF Shadow/E8000 - EFFFF Shadow

These categories determine whether optional ROM will be copied to RAM by 16K byte. You can enable the optional shadow or you can disable it. The default setting is disabled.

ROM PCI/ISA BIOS (2A51M2I9) CHIPSET FEATURES SETUP AWARD SOFTWARE, INC.			
Refresh Rate Control	: 15.6us	System BIOS Cacheable	: Enabled
Ref/Act Command Delay	: 6T	Video BIOS Cacheable	: Enabled
Refresh Queue Depth	: 12	Memory Hole at 15M-16M	: Disabled
RAS Precharge Time	: 3T	PCI Post Write Buffer	: Disabled
RAS to CAS Delay	: 3T	PCI Delayed Transaction	: Enabled
ISA Bus Clock Frequency	: PCICLK/4		
Starting Point of Paging	: 1T		
MA# Enable	: Enabled		
Asyn/Sync Mode CPU/DRAM	: Asynchronous		
SDRAM CAS Latency	: 3T		
SDRAM WR Retire Rate	: X-2-2-2		
DRAM Opt RAS Precharge	: Disabled		
PCI Peer Concurrency	: Disabled		
Read Prefetch Memory RD	: Enabled		
Assert TRDY After Prefet	: 2 QWs	ESC : Quit	↑↓←→ : Select Item
CPU to PCI Burst Mem. WR	: Disabled	F1 : Help	PU/PD/+/- : Modify
CPU to PCI Post Write	: Disabled	F5 : Old Values	<Shift>F2 : Color
AGP Aperture Size	: 64MB	F6 : Load BIOS Defaults	
		F7 : Load Setup Defaults	

Chipset Features Setup

Choose Chipset Features Setup on the Setup main menu. All Chipset Setup options are then displayed.

Refresh Rate Control

This field sets the Refresh Rate Control timing.

The Choice: 15.6us, 7.8us, 3.9us

Ref/Act Command Delay

This field sets the Ref/Act Command Delay timing.

The Choice: 5T, 6T, 7T, 8T

Refresh Queue Depth

This field sets the Refresh Queue Depth

The Choice: 0, 4, 8, 12

RAS Precharge Time

This field sets the RAS Precharge timing.

The Choice: 2T, 3T, 4T, 5T.

RAS to CAS Delay

This field sets the RAS to CAS Delay timing.

The Choice: 2T, 3T, 4T, 5T.

ISA Bus Clock Frequency

This field sets the ISA Bus Clock Frequency.

The Choice: PCICLK/4, PCICLK/3, 7.159MHz

Starting Point of Paging

This field sets the Starting Point of Paging timing.
The Choice: 1T, 2T, 4T, 8T.

SDRAM CAS latency

This field sets the CAS latency timing.
The Choice: 2T, 3T.

SDRAM WR Retire Rate

This field sets the SDRAM WR Retire Rate.
The Choice: X-1-1-1, X-2-2-2.

DRAM Opt RAS Precharge

This field sets the DRAM Opt RAS Precharge.
The Choice: Enable, Disable.

PCI Peer Concurrency

This field sets the PCI Peer Concurrency.
The Choice: Enable, Disable.

Read Prefetch Memory RD

This field sets the Read Prefetch Memory RD.
The Choice: Enable, Disable.

Assert TRDY After Prefet

This field sets the Assert TRDY After Prefet.
The Choice: 1QWs, 2QWs, .

CPU to PCI Burst MEM. WR

This field sets the CPU to PCI Burst MEM. WR.
The Choice: Enable, Disable.

CPU to PCI Post Write

This field sets the CPU to PCI Post Write.
The Choice: Enable, Disable.

System BIOS Cacheable

Select Enabled allows caching of the System BIOS , resulting in better system performance.
The Choice: Enable, Disable.

Video BIOS Cacheable

Select Enabled allows caching of the video RAM , resulting in better system performance. However, if any program writes to this memory area, a system error may result.
Enabled Video RAM access cached
Disabled Video RAM access not cached

Memory Hole At 15M-16M

In order to improve performance, certain space in memory can be reserved for ISA cards. This memory must be mapped into the memory space below 16 MB.
Enabled Memory hole supported.
Disabled Memory hole not supported.

AGP Aperture Size (MB)

Select the size of the Accelerated Graphics Port (AGP) aperture. The aperture is a portion of the PCI memory address range dedicated for graphics memory address space. Host cycles that hit the aperture range are forwarded to the AGP without any translation.

The choice: 4, 8, 16, 32, 64, 128, 256

PCI Post Write Buffer

This field sets the PCI Post Write Buffer.

The Choice: Enable, Disable.

PCI Delay Transaction

This field sets the PCI Delay Transaction.

The Choice: Enable, Disable.

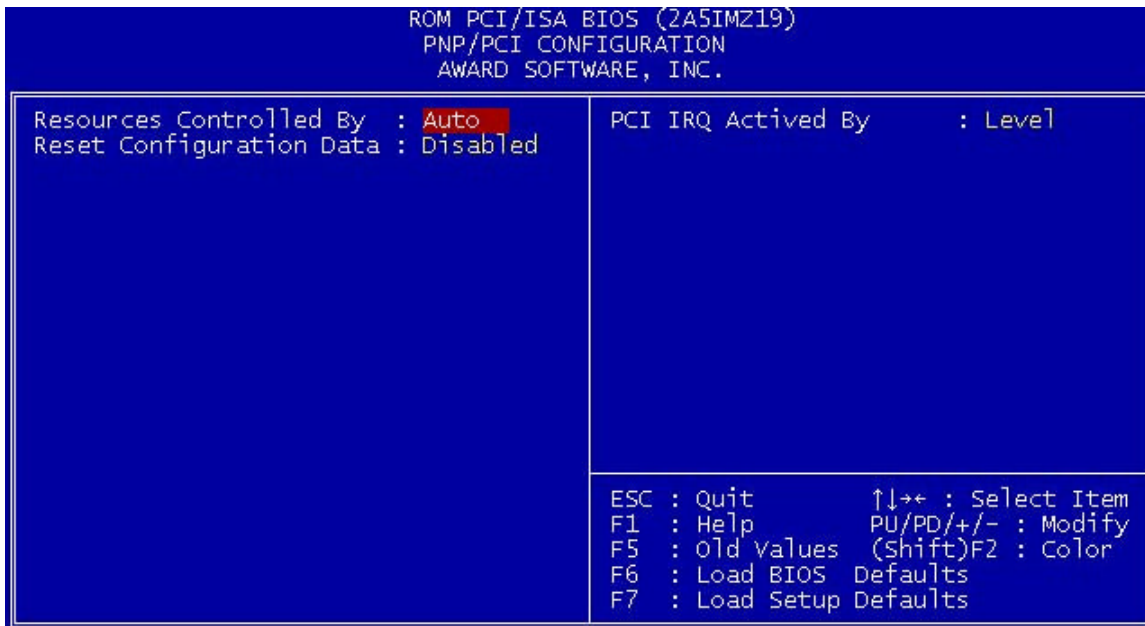

PCI/PnP Configuration Setup

Choose PCI/Plug and Play Setup from the BIOS Setup screen to display the PCI and Plug and Play Setup options, described below.

Resources Controlled by

The Award Plug and Play BIOS can automatically configure all the boot and Plug and Play-compatible devices. If you select Auto, all the interrupt request (IRQ) and DMA assignment fields disappear, as the BIOS automatically assigns them.

The choice: Auto and Manual.

Reset Configuration Data

Normally, you leave this field Disabled. Select Enabled to reset Extended System Configuration Data (ESCD) when you exit Setup if you have installed a new add-on and the system reconfiguration has caused such a serious conflict that the operating system cannot boot.

The choice: Enabled and Disabled.

IRQ n Assigned to

When resources are controlled manually, assign each system interrupt as one of the following types, depending on the type of device using the interrupt:

Legacy ISA Devices compliant with the original PC AT bus specification, requiring a specific interrupt (such as IRQ4 for serial port 1). PCI/ISA PnP Devices compliant with the Plug and Play standard whether designed for PCI or ISA bus architecture.

```

ROM PCI/ISA BIOS (2A51M219)
POWER MANAGEMENT SETUP
AWARD SOFTWARE, INC.

ACPI function      : Enabled
Power Management  : User Define
Video Off Option   : Susp,Stby -> Off
Video Off Method   : U/H SYNC+Blank
Switch Function    : Break/Wake
Doze Speed (div by): 2/8
Stdby Speed(div by): 1/8
MODEM Use IRQ     : 3
Hot Key Function As: Power Off

** PM Timers **
HDD Off After     : Disable
Doze Mode         : Disable
Standby Mode      : Disable
Suspend Mode      : Disable

** PM Events **
HDD Ports Activity : Enabled
COM Ports Activity : Enabled
LPT Ports Activity : Enabled

UGA Activity      : Enabled
IRQ [3-7,9-15],NMI : Enabled
IRQ 8 Break Suspend : Disabled
Power Button Over Ride : Delay 4 Sec
LAN Power Up Control : Enabled

Power Up by Alarm : Disabled

ESC : Quit          ↑↓←→ : Select Item
F1  : Help          PU/PD/+/- : Modify
F5  : Old Values   <Shift>F2 : Color
F6  : Load BIOS Defaults
F7  : Load Setup Defaults

```

Power Management Setup

The BIOS Setup options described in this section are selected by choosing Power Management Setup from the BIOS Setup main menu.

ACPI function

This item allows you to enable/disable the Advanced Configuration and Power Management (ACPI).
The choice: Enabled, Disabled.

Power Management

This category allows you to select the type (or degree) of power saving and is directly related to the following modes:

1. HDD Power Down
2. Doze Mode
3. Suspend Mode
4. Standby Mode

There are three selections for Power Management, three of which have fixed mode settings.

- Disable (default)** No power management. Disables all four modes Min. Power Saving Minimum power management. Doze Mode = 1 hr. Standby Mode = 1 hr., Suspend Mode = 1 hr., and HDD Power Down = 15 min.
- Max. Power Saving** Maximum power management -- ONLY AVAILABLE FOR SL CPU'S. Doze Mode = 1 min., Standby Mode = 1 min., Suspend Mode = 1 min., and HDD Power Down = 1 min.
- User Defined** Allows you to set each mode individually. When not disabled, each of the ranges are from 1 min. to 1 hr. except for HDD Power Down which ranges from 1 min. to 15 min. and disable.
- PM Control APM** When enabled, an Advanced Power Management device will be activated to enhance the Max. Power Saving mode and stop the CPU internal clock. If the Max. Power Saving is not enabled, this will be preset to No.
- Video Off Option** Selects the power-saving modes during which the monitor goes blank:
Always On Monitor remains on during power-saving modes.
Suspend --> Off Monitor blanked when system enters Suspend mode.
All Modes --> Off Monitor blanked when system enters any power saving mode.
- Video Off Method** This determines the manner in which the monitor is blanked.
- V/H SYNC+Blank This selection will cause the system to turn off the vertical and horizontal synchronization ports and write blanks to the video buffer.
- Blank Screen This option only writes blanks to the video buffer.
- DPMS Initial display power management signaling.

PM Timers

The following four modes are Green PC power saving functions which are only user configurable when User Defined Power Management has been selected. See above for available selections.

HDD Power Down

When enabled and after the set time of system inactivity, the hard disk drive will be powered down while all other devices remain active.

Doze Mode

When enabled and after the set time of system inactivity, the CPU clock will run at slower speed while all other devices still operate at full speed.

Suspend Mode

When enabled and after the set time of system inactivity, all devices except the CPU will be shut off. The Choice: Instant-Off, Delay 4 Sec.

PM Events

PM events are I/O events whose occurrence can prevent the system from entering a power saving mode or can awaken the system from such a mode. In effect, the system remains alert for anything which occurs to a device which is configured as On, even when the system is in a power down mode.

HDD / COM / LPT / VGA Ports Activity	- Options : Disable / Enable
IRQ [3-7,9-15], NMI	- Options : Disable / Enable
IRQ 8 Break Suspend	- Options : Disable / Enable
Power Button Over Ride	- Options : Delay 4 Sec / Instant Off
Ring Power Up Control	- Options : Disable / Enable
LAN Power Up Control	- Options : Disable / Enable
Power Up by Alarm	- Options : Disable / Enable
Month Alarm	- Option : 1 / 0
Day of Month Alarm	- Option : 1 ... 31
Week Alarm	- Set the option on/off for *** SUN....SAT***
Time (hh:mm:ss) Alarm	- Set the time for Alarm

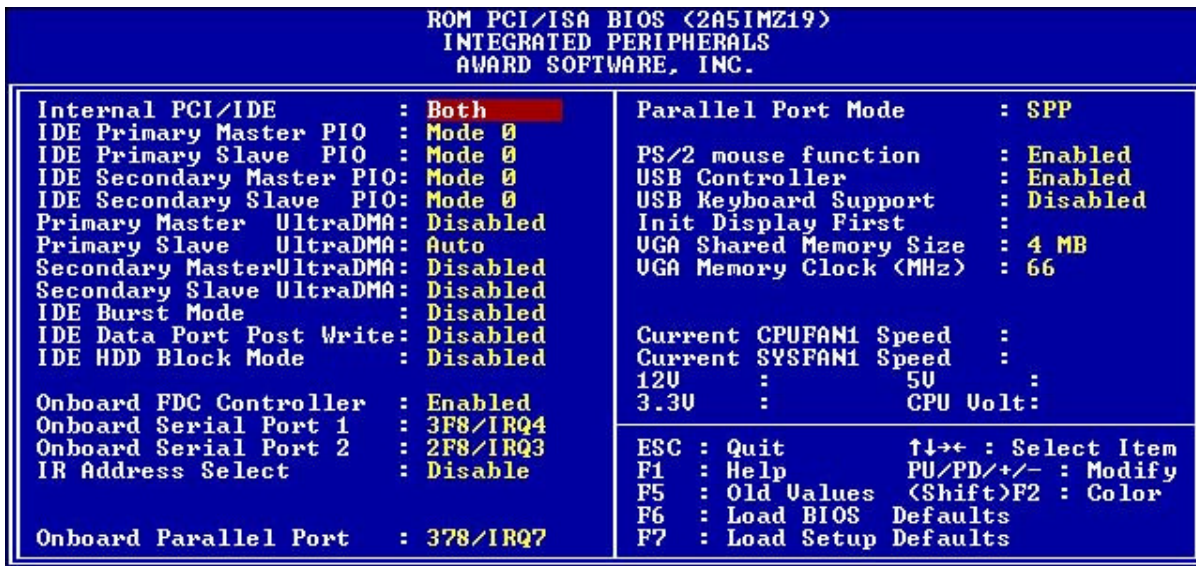

Integrated Peripheral Setup

Integrated Peripheral Setup options are displayed by choosing Peripheral Setup from the BIOS Setup main menu. All Peripheral Setup options are described here.

Internal PCI / IDE

The chipset contains a PCI IDE interface with support for two IDE channels. Select Enabled to activate the first and/or second IDE interface. Select Disabled to deactivate an interface, if you install a primary and/or secondary add-in IDE interface.

The choice: Both, Disabled.

IDE Burst Mode

The onboard IDE drive interfaces supports IDE prefetching, for faster drive accesses. If you install a primary and/or secondary add-in IDE interface, set this field to Disabled if the interface does not support prefetching.

The choice: Enabled, Disabled.

IDE HDD Block Mode

This allows your hard disk controller to use the fast block mode to transfer data to and from your hard disk drive (HDD).

Enabled IDE controller uses block mode.

Disabled IDE controller uses standard mode.

IDE Primary/Secondary Master/Slave PIO

The four IDE PIO (Programmed Input/Output) fields let you set a PIO mode (0-4) for each of the four IDE devices that the onboard IDE interface supports. Modes 0 through 4 provide successively increased performance. In Auto mode, the system automatically determines the best mode for each device.

IDE Primary/Secondary Master/Slave UDMA

Ultra DMA/33 implementation is possible only if your IDE hard drive supports it and the operating environment includes a DMA driver (Windows 95 OSR2 or a third-party IDE bus master driver). If your hard drive and your system software both support Ultra DMA/33, select Auto to enable BIOS support.

The Choice: Auto, Disabled

Init Display First

This item allows you to decide to active PCI Slot or AGP first

The choice: PCI Slot, AGP.

Onboard FDD Controller

This should be enabled if your system has a floppy disk drive (FDD) installed on the system board and you wish to use it. Even when so equipped, if you add a higher performance controller, you will need to disable this feature.

The Choice: Enabled, Disabled.

USB Controller The Choice: Enabled, Disabled.

USB Key board Support The Choice: Enabled, Disabled.

VGA Shared Memory Size - Set the VGA Shared Memory Size option.

The Choice: None, 2 , 4, 8 MB

VGA Memory Clock - Set the VGA Memory Clock.

The Choice: 66, 75, 83, 100

Onboard Serial Port 1/Port 2

This item allows you to determine access onboard serial port 1/port 2 controller with which I/O address.

The Choice: 3F8/IRQ4, 2F8/IRQ3, 3E8/IRQ4, 2F8/IRQ3, Disabled, Auto.

IR IRQ Address

The Choice: Disable, 3F8H, 2F8H

IR Mode

This item allows you to determine which Infra Red (IR) function of onboard I/O chip.

The Choice: Standard, ASKIR, HPSIR.

IR IRQ Select

The Choice: Disable, IRQ3,IRQ4,IRQ10,IRQ11

Onboard Parallel Port Mode

Select an operating mode for the onboard parallel (printer) port. Normal EPP (Extended Parallel Port) ECP (Extended Capabilities Port) CEP+EPP PC AT parallel port Bidirectional port Fast, buffered port Fast, buffered, bidirectional port.

Select Normal unless you are certain your hardware and software both sup

Onboard Parallel Port

Select a logical LPT port name and matching address for the physical parallel (printer) port.

The choice: 378H/IRQ7, 278H/IRQ5, 3BCH/IRQ7, Disabled.
port EPP or ECP mode.

Choices are SPP, ECP/EPP, ECP, EPP/SPP.

ECP Mode Use DMA

Select a DMA channel for the port.

Choices are 3, 1.

Parallel Port EPP Type

Select EPP port type 1.7 or 1.9.

SAVE AND EXIT SETUP

Select this option when you finished setup the CMOS and it will save the change you made and reboot the system after you press "YES".

EXIT WITHOUT SAVING

If you decided not to save any change you had made, you can select this option to exit the CMOS setup and all the change you made will be ignored.

Driver Installation Guide

**Insert the driver CD into CD-ROM drive in windows for Autorun.
Follow the CD's instructions to install drivers for mainboard.**

Supplementary Jumper Guide

Please set the jumper manually according to the CPU's marking before boot up the system. Using the tables on page 18-20 to set the suitable **CPU Core, External Bus Speed & Bus Frequency Ratio**.

For the following table:

1. CPU Voltage Setting Table

2. Set the External Bus Speed (MHz) and Bus Frequency Ratio

3. All CPU / SDRAM / PCI Frequency Setting Table

4. Bus Frequency Ratio Setting Table

- *SET JUMPER "CLOSE" [1-2]*
- *SET JUMPER "OPEN" [2-3]*