

Preface

Copyright

This publication, including all photographs, illustrations and software, is protected under international copyright laws, with all rights reserved. Neither this manual, nor any of the material contained herein, may be reproduced without written consent of the author.

Version 1.0

Disclaimer

The information in this document is subject to change without notice. The manufacturer makes no representations or warranties with respect to the contents hereof and specifically disclaims any implied warranties of merchantability or fitness for any particular purpose. The manufacturer reserves the right to revise this publication and to make changes from time to time in the content hereof without obligation of the manufacturer to notify any person of such revision or changes.

Trademark Recognition

Microsoft, MS-DOS and Windows are registered trademarks of Microsoft Corp.

MMX, Pentium, Pentium-II, Pentium-III, Celeron are registered trademarks of Intel Corporation.

Other product names used in this manual are the properties of their respective owners and are acknowledged.

Federal Communications Commission (FCC)

This equipment has been tested and found to comply with the limits for a Class B digital device, pursuant to Part 15 of the FCC Rules. These limits are designed to provide reasonable protection against harmful interference in a residential installation. This equipment generates, uses, and can radiate radio frequency energy and, if not installed and used in accordance with the instructions, may cause harmful interference to radio communications. However, there is no guarantee that interference will not occur in a particular installation. If this equipment does cause harmful interference to radio or television reception, which can be determined by turning the equipment off and on, the user is encouraged to try to correct the interference by one or more of the following measures:

- Reorient or relocate the receiving antenna.
- Increase the separation between the equipment and the receiver.
- Connect the equipment onto an outlet on a circuit different from that to which the receiver is connected.
- Consult the dealer or an experienced radio/TV technician for help.

Shielded interconnect cables and a shielded AC power cable must be employed with this equipment to ensure compliance with the pertinent RF emission limits governing this device. Changes or modifications not expressly approved by the system's manufacturer could void the user's authority to operate the equipment.

Declaration of Conformity

This device complies with part 15 of the FCC rules. Operation is subject to the following conditions:

- This device may not cause harmful interference, and
- This device must accept any interference received, including interference that may cause undesired operation.

Canadian Department of Communications

This class B digital apparatus meets all requirements of the Canadian Interference-causing Equipment Regulations.

Cet appareil numérique de la classe B respecte toutes les exigences du Règlement sur le matériel brouilleur du Canada.

About the Manual

The manual consists of the following:

Chapter 1 Introducing the Mainboard	Describes features of the mainboard, and provides a shipping checklist. Go to ⇒ page 1
Chapter 2 Installing the Mainboard	Describes installation of mainboard components. Go to ⇒ page 7
Chapter 3 Using BIOS	Provides information on using the BIOS Setup Utility. Go to ⇒ page 25
Chapter 4 Using the Mainboard Software	Describes the mainboard software. Go to ⇒ page 51

Features and Packing List Translations

Liste de contrôle

Comparez ce qui est contenu dans l'emballage de la carte mère avec la liste suivante:

Eléments standards

- Une carte mère
- Un câble plat pour lecteur de disquette
- Un câble plat pour lecteur IDE
- Un CD d'installation automatique pour le logiciel
- Un écran pour panneau arrière d'entrées/sorties
- Ce manuel utilisateur

Caractéristiques

Processeur	<p>La carte mère utilise un Socket A AMD 462 broches présentant les caractéristiques suivantes:</p> <ul style="list-style-type: none">• Supporte un bus frontal (FSB) de 200/266/333 MHz• Intègre les processeurs AMD Duron, Athlon, et Athlon XP <hr/> <p>Remarque: Il est conseillé d'utiliser AMD Athlon XP ou CPU de niveau plus élevé pour assurer que la fonction "Diode Thermique" fonctionne correctement.</p>
Chipset	<p>Le chipset sur SV400 comprend le KT400 Northbridge et VT8235 Southbridge basés sur une architecture novatrice et dimensionnable avec une fiabilité et des performances prouvées. Quelques-unes des caractéristiques avancées des chipsets sont:</p> <ul style="list-style-type: none">• Support d'adresse indépendante, données, et interfaces de surveillance• Transfert DDR (Double Data Rate) 200/166/133/100 MHz sur adresse CPU Athlon et bus de données• Support de modes de transfert 533 MHz 8x, 266 MHz 4x, et 133 MHz 2x pour signalisation Ad et SBA• AGP v3.0 conforme au mode de transfert 8x• Supporte une interface d'hôte V-Link 66 MHz avec une bande passante de pointe de 533 Mo/sec• Interface DRAM synchrone avec CPU d'hôte (166/133/100 MHz) pour une configuration plus flexible• Contrôleur Fast Ethernet intégré avec capacités 1/10/100 Mbits• Contrôleur EIDE de mode maître UltraDMA-33/66/100/133 de Canal double• Vitesse de transfert jusqu'à 133Mo/sec pour couvrir les pilotes PIO mode 4, multi-mots DMA mode 2, et interface UltraDMA-33• Compatible USB v2.0 et Interface de Contrôleur d'Hôte Avancé (EHCI) v1.0• Supporte à la fois la gestion d'alimentation ACPI

	<p>(Advanced Configuration and Power Interface) et legacy (APM)</p> <p>Les caractéristiques supplémentaires comprennent le support pour six ports USB, une liaison AC 97 pour audio et modem, surveillance matérielle, et gestion d'alimentation ACPI/OnNow.</p>
Mémoire	<ul style="list-style-type: none"> • Support de module mémoire DDR SDRAM jusqu'à 200/266/333/400 MHz (amélioré) • Peut recevoir trois logements sans mémoire tampon en 2.5V de 184 broches • Chaque logement supporte jusqu'à 1 Go avec une capacité maximum totale de 3 Go.
Graphiques	<p>La SV400 inclus un logement AGP qui offre huit fois la bande passante des spécifications AGP d'origine. L'AGP 3.0 (8xAGP) offre une amélioration significative de performances accompagnée d'améliorations de fonctionnalités sur l'AGP2.0. Cette interface représente l'évolution naturelle de l'AGP existante pour répondre à une demande toujours croissante d'interfaces graphiques en environnements de station de travail et de bureau.</p>
Codec Audio AC'97	<p>Le codec Audio AC'97 est conforme aux spécifications AC 97 2.2 répondant aux exigences PC2001 et supportant la Sortie S/PDIF. Il possède aussi une mémoire tampon intégrée et PLL interne. Les fonctionnalités comprennent le support du commutateur analogique pour sortie arrière (partagée), la prise de ligne d'entrée (partagée), centre basse (partagée), et prise MIC à la sortie audio 6 canaux.</p>
Options d'Extensions	<p>SV400 a cinq logements PCI 32 bits, un logement AGP (supportant seulement la carte AGP 1.5V) et logement CNR (Communications and Networking Riser).</p> <p>Le SV400 supporte la maîtrise de bus Ultra DMA avec des vitesses de transfert de 33/66/100/133 Mo/sec.</p>
LAN Interne (optionnel)	<p>Le VT6103 est un périphérique à Couche Physique pour Ethernet 10BASE-T et 100BASE-TX utilisant des câbles Non blindés de catégorie 5, Blindés de Type 1, et à Fibres Optiques.</p> <ul style="list-style-type: none"> • Double Vitesse – 100/10 Mbps • Half et Full Duplex • Conforme à tous les Standards IEEE 802.3, 10Base-T et 100Base-Tx Applicables • Egaliseur Adaptatif
1394a (Optionnel)	<ul style="list-style-type: none"> • Contrôleur d'hôte VT6307 PCI 1394a intégré • Conforme aux spécifications 1394 open HCI v1.0 et v1.1 • Supporte les provisions du standard IEEE 1394-1995 pour bus série de hautes performances et le supplément P1394a 4.0 • Générateur CRC 32 bits CRC et vérificateur pour recevoir et émettre des données • Conforme aux spécifications PCI v2.2 • Support de maîtrise de bus de hautes performances • Offre deux ports câbles entièrement compatibles 1394a à 100/200/400 Mbits par seconde

E/S Intégrées	<p>La carte mère possède un jeu complet de ports d'E/S et de connecteurs:</p> <ul style="list-style-type: none">• Deux ports PS/2 pour souris et clavier• Deux ports série• Un port parallèle• Quatre ports USB• Un port 1394a (optionnel)• Un port LAN (optionnel)• Prises audio pour microphone, ligne d'entrée et ligne de sortie
Microprogramme BIOS	<p>Cette carte mère utilise Award BIOS qui permet aux utilisateurs de configurer de nombreuses caractéristiques du système comprenant les suivantes:</p> <ul style="list-style-type: none">• Gestion d'alimentation• Alarmes de réveil• Paramètres de CPU• Synchronisation de CPU et de mémoire <p>Le microprogramme peut aussi être utilisé pour définir les paramètres pour les vitesses d'horloges de différents processeurs.</p>

Checkliste

Vergleichen Sie den Packungsinhalt des Motherboards mit der folgenden Checkliste:

Standard Items

- Ein Motherboard
- Ein Bandkabel für Diskettenlaufwerke
- Ein Bandkabel für IDE-Laufwerke
- Eine Auto-Installations-Support-CD
- I/O-Anschlussabdeckung für die Rückwand
- Dieses Benutzerhandbuch

Features

Prozessor	<p>Das Mainboard verwendet einen AMD 462-Pin Socket A mit den folgenden Eigenschaften:</p> <ul style="list-style-type: none">• Unterstützt 200/266/333 MHz Frontsidebus (FSB)• Nimmt AMD Duron, Athlon und Athlon XP-Prozessoren auf <hr/> <p>Hinweis: Die Verwendung einer CPU vom Typ AMD Athlon XP oder höher wird empfohlen, damit die Funktion „Thermische Diode“ richtig funktioniert.</p>
Chipsatz	<p>Der Chipsatz des SV400 enthält KT400 Northbridge und VT8235 Southbridge, die auf einer innovativen und skalierbaren Architektur mit bewiesener Zuverlässigkeit und Leistung basieren. Einige der modernen Eigenschaften des Chipsatzes:</p> <ul style="list-style-type: none">• Unterstützt unabhängige Adressen, Daten- und Snoop-Interfaces• 200/166/133/100 MHz DDR (Double Data Rate) Transfer auf Athlon CPU-Adressen- und Datenbussen• Unterstützt 533 MHz 8x, 266 MHz 4x und 133 MHz 2x Transfermodi für Ad- und SBA-Signalisieren• AGP v3.0 kompatibel mit 8x Transfermodus• Unterstützt 66 MHz V-Link Host-Interface mit einer maximalen Bandbreite von 533 MB/s• DRAM-Interface synchron mit Host-CPU (166/133/100 MHz) für die flexibelste Konfiguration• Integrierter Fast Ethernet-Controller mit einer Leistung von 1/10/100 Mbit• Dualkanal-UltraDMA-33/66/100/133 Mastermodus EIDE-Controller• Transferraten bis zu 133MB/s für PIO-Modus 4, Multi-Word DMA-Modus 2-Treiber und UltraDMA-33Interface• USB v2.0 und Enhanced Host Controller Interface (EHCI) v1.0 kompatibel• Unterstützt sowohl ACPI (Advanced Configuration and Power Interface) als auch Legacy- (APM)

	<p>Energieverwaltung</p> <p>Zusätzliche Eigenschaften umfassen die Unterstützung für sechs USB-Ports, ein AC 97-Link für Audio und Modem, Hardwareüberwachung und ACPI/OnNow-Energieverwaltung.</p>
Speicher	<ul style="list-style-type: none"> • Unterstützt DDR SDRAM Speichermodul bis zu 200/266/333/ (erweitert) MHz • Nimmt drei ungepufferte 184-Pin 2.5V Steckplätze auf • Jeder Steckplatz unterstützt bis zu 1 GB mit einer Gesamtkapazität von 3 GB
Grafik	<p>Das SV400 verfügt über einen AGP-Steckplatz, der gegenüber der ursprünglichen AGP-Spezifikation über die achtfache Bandbreite verfügt. AGP 3.0 (8xAGP) bietet gegenüber AGP 2.0 eine erhebliche Leistungssteigerung und verbesserte Features. Dieses Interface stellt die natürliche Evolution des bestehenden AGP dar, um den stetig anwachsenden Anforderungen an die Grafikschnittstellen innerhalb der Workstations und Desktop-Umgebungen gerecht zu werden.</p>
AC' 97 Audio Codec	<p>Der AC 97 Audio-Codec ist kompatibel mit der AC 97 2.2-Spezifikation und unterstützt PC2001 und S/PDIF Out. Weiterhin verfügt es über einen eingebauten Puffer und interne PLL. Funktionen umfassen Unterstützung für Analog Switch für den hinteren Ausgang (gemeinsam), die Line-in-Buchse (gemeinsam), Mitte/Bass (gemeinsam) und MIC-Buchse für 6-Kanal-Audioausgang..</p>
Erweiterungsoptionen	<p>Das SV400 verfügt über fünf 32-Bit PCI-Steckplätze, einen AGP-Steckplatz (unterstützt nur 1.5V 4x AGP-Karte) und einen CNR (Communications and Networking Riser)-Steckplatz.</p> <p>Das SV400 unterstützt Ultra DMA Bus-Mastering mit Transferraten von bis zu 33/66/100/133 MB/s.</p>
Integriertes LAN (optional)	<p>Das VT6103 ist ein Physical-Layer-Gerät für Ethernet 10BASE-T und 100BASE-TX bei Benutzung von nicht abgeschirmten Kategorie 5-Kabeln, abgeschirmten Typ 1-Kabeln und Glasfaserkabeln.</p> <ul style="list-style-type: none"> • Zwei Geschwindigkeiten – 100/10 MB/Sek. • Halb- und Voll duplex • Entspricht allen geltenden IEEE 802.3, 10Base-T und 100Base-Tx-Standards • Einstellbarer Equalizer
1394a (optional)	<ul style="list-style-type: none"> • VT6307 PCI 1394a integrierter Host-Controller • Entspricht den 1394 Open HCI Spezifikationen v1.0 und v1.1 • Unterstützt Bereitstellung von IEEE 1394-1995 Standard Hochleistungs-Serial Bus und den P1394a Zusatz 4.0 • 32 bit CRC-Generator und Checker für Datenempfang und Datenübertragung. • Entspricht PCI Spezifikation v2.2 • Unterstützung für Hochleistungs-Bus-Mastering • Bietet zwei vollständig 1394a kompatible Kabelanschlüsse mit 100/200/400 Mbit pro Sekunde

Integrierte I/O	<p>Das Mainboard verfügt über einen kompletten Satz von I/O-Schnittstellen und Anschlüssen:</p> <ul style="list-style-type: none"> • Zwei PS/2-Schnittstellen für Maus und Tastatur • Zwei serielle Schnittstellen • Eine parallele Schnittstelle • Vier USB-Anschlüsse • Ein 1394a-Anschluss (optional) • Eine LAN-Schnittstelle (optional) • Audiobuchsen für Mikrofon, Line-in und Line-out
BIOS Firmware	<p>Dieses Mainboard setzt das Award BIOS ein, mit dem der Anwender viele Systemeigenschaften selbst konfigurieren kann, einschließlich der folgenden:</p> <ul style="list-style-type: none"> • Energieverwaltung • Wake-up Alarm • CPU-Parameter • CPU- und Speichertiming <p>Mit der Firmware können auch die Parameter für verschiedene Prozessortaktgeschwindigkeiten eingestellt werden.</p>

Lista di controllo

Confrontate il contenuto della confezione della scheda madre con la seguente lista di controllo:

Articoli standard

- Una scheda madre
- Un cavo a nastro per il drive dischetti
- Un cavo a nastro IDE
- Un CD di supporto software auto-installante
- Una protezione per il pannello posteriore di I/O
- Il manuale dell'utente

Caratteristiche

Processore	<p>La scheda madre usa un socket AMD 462-pin Socket A con le seguenti caratteristiche:</p> <ul style="list-style-type: none">• Supporto per il bus di sistema frontside (FSB) 200/266/333 MHz• Alloggia i processori AMD Duron, Athlon e Athlon XP <hr/> <p>Nota: Si raccomanda l'uso di una CPU AMD Athlon XP o superiore per garantire il funzionamento corretto della funzione "Diodo termico".</p> <hr/>
Chipset	<p>Il chipset SV400 è composto dai chipset Northbridge KT400 e Southbridge VT8235 basati su un'architettura innovativa e facilmente espandibile dall'affidabilità e dalle prestazioni dimostrate. Alcune delle caratteristiche avanzate del chipset sono:</p> <ul style="list-style-type: none">• Supporto per interfacce indirizzo, dati e snoop indipendenti• Trasferimento 200/166/133/100 MHz DDR (Double Data Rate) su bus indirizzo e dati CPU Athlon• Supporta modalità di trasferimento 533 MHz 8x, 266 MHz 4x, e 133 MHz 2x per segnalazione Ad e SBA• Compatibile AGP v3.0 con modalità di trasferimento 8x• Supporta interfaccia host V-Link a 66 MHz con una larghezza di banda complessiva di 533 MB/sec• Interfaccia DRAM sincrona con CPU host (166/133/100 MHz) per una maggiore flessibilità di configurazione• Controller Fast Ethernet integrata con capacità 1/10/100 Mbit• Controller EIDE modalità master doppio canale Ultra DMA 33/66/100/133• Velocità di trasferimento fino a 133MB/sec per coprire i driver in modalità multi-word DMA 2, modalità PIO 4 e interfaccia UltraDMA-33• Compatibile USB v2.0 e Enhanced Host Controller Interface (EHCI) v1.0• Supporto sia per la gestione energetica ACPI (Advanced Configuration and Power Interface) che per la precedente (APM)

	Caratteristiche aggiuntive includono il supporto per sei porte USB, un collegamento AC 97 per audio e modem, monitoraggio hardware e gestione energetica ACPI/OnNow.
Memoria	<ul style="list-style-type: none"> • Supporta un modulo di memoria SDRAM con DDR fino a 200/266/333/400 (enhanced) Mhz • Presenta tre slot a 184 pin 2,5 V unbuffered • Ciascun slot supporta fino a 1 GB per una capacità totale massima di 3 GB
Grafica	La scheda SV400 include uno slot AGP che fornisce otto volte la larghezza di banda delle specifiche AGP originarie. Lo standard AGP 3.0 (8xAGP) garantisce prestazioni significativamente superiori oltre ad altri miglioramenti rispetto allo standard AGP2.0. Questa interfaccia rappresenta la naturale evoluzione dell'AGP esistente ed è in grado di soddisfare le sempre maggiori aspettative del mercato nel campo delle interfacce grafiche, sia in ambiente workstation che in ambiente desktop
AC' 97 Audio Codec	Il codec Audio AC'97 è conforme alla specifica AC 97 2.2 che soddisfa i requisiti PC2001 e supporta Uscita S/PDFI. Inoltre ha una memoria tampone interna e PLL interno. Le caratteristiche includono supporto per interruttore analogico sull'uscita posteriore (condivisa), il jack di ingresso linea (condiviso), centrale/bassi (condivisi), e jack MIC per fornire un'uscita a 6 canali audio.
Opzioni di espansione	La scheda SV400 presenta cinque slot PCI a 32 bit, uno slot AGP (compatibile solamente con la scheda 4x AGP 1,5V) ed uno slot CNR (Communications and Networking Riser). La scheda SV400 supporta il bus mastering Ultra DMA con transfer rate 33/66/100/133 MB/sec.
LAN integrata (Opzionale)	La scheda VT6103 è una periferica Physical Layer per Ethernet 10BASE-T e 100BASE-TX usando cavi schermati tipo 1 e non schermati categoria 5 e cavi di fibra ottica. <ul style="list-style-type: none"> • Doppia velocità – 100/10 Mbps • Half e Full duplex • Conforme a tutti gli standard applicabili IEEE802.3, 10Base-T e 100Base-TX • Equalizzatore adattivo
1394a (opzionale)	<ul style="list-style-type: none"> • Controller VT6307 PCI 1394a integrato • Conforme alle specifiche 1394 open HCI v1.0 e v1.1 • Supporto delle specifiche IEEE 1394-1995 per l'ottenimento di alte prestazioni ed inoltre per l'aggiornamento al P1394a 4.0. • Generatore CRC a 32 bit e controllore per ricevere e trasmettere dati • Compatibile con le specifiche PCI v2.2 • Supporto per il bus principale ad alte prestazioni • Presenti due porte conformi allo standard 1394a capaci di un trasferimento dati a 100/200/400 Mbit al secondo

Inizializza I/O	<p>La scheda madre è dotata da una serie completa di porte e connettori I/O:</p> <ul style="list-style-type: none"> • Due porte PS/2 per tastiera e mouse • Due porte seriali • Una porta parallela • Quattro porte USB • Una porta 1394 (opzionale) • Una porta LAN (opzionale) • Jack audio per microfono, ingresso linea e uscita linea
Firmware BIOS	<p>Questa scheda madre adotta un BIOS Award che permette agli utenti di configurare le caratteristiche principali del sistema, inclusi:</p> <ul style="list-style-type: none"> • Gestione energia • Allarmi wake up • Parametri CPU • Temporizzazione CPU e memoria <p>Il firmware può anche essere usato per impostare i parametri per diverse velocità di clock.</p>

Lista de Verificación

Compare los contenidos del paquete de la placa principal con la sigte. lista:

Ítems Estándares

- Una placa principal
- Un cable cinta del lector de diskette
- Un cable cinta de la unidad IDE
- Un CD de soporte en software de autoinstalación
- Un protector del panel I/O trasero
- Este manual del usuario

Características

Procesador	<p>El panel principal usa un AMD 462-pin Enchufe A que tiene las siguientes características:</p> <ul style="list-style-type: none">• Permite 200/266/333 MHz bus de lado frontal (FSB)• Adecua procesadores AMD Duron, Athlon, and Athlon XP <p>Nota: Se recomienda que usted use AMD Athlon XP u otra CPU de nivel superior para asegurarse de que la función “Diodo Termal” trabajará adecuadamente.</p>
Chipset	<p>El chipset en SV400 incluye la KT400 Northbridge y VT8235 Southbridge las cuales se basan en una arquitectura innovadora y escalada con probada fidelidad y realización. Algunas de las características avanzadas del chipset son:</p> <ul style="list-style-type: none">• VIA Apollo KM266 integrado y Gráficos S3 ProSavage8™ 128-bit 2D/3D controlador de gráficos con rendimiento equivalente a 4x AGP en un chip individual• Circuitos incorporados Phase Lock Loop para control asimétrico óptimo adentro y entre las regiones de cronometrización• Permite Interfaz de receptor 66MHz V-Link con un máximo de ancho de banda de 266MB/por segundo• AGP v3.0 adaptable con modo de transferencia 8x• Inter.-operable con Receptor VIA para Controlador de Receptor Vlink• Interfaz síncrona DRAM con CPU servidor (166/133/100 MHz) para una configuración más flexible• Controlador Fast Ethernet integrado con capacidad de 1/10/100 Mbit• PCI para datos de la memoria del sistema que corren hasta 132 Mb/por segundo (datos enviados a north bridge mediante Interfaz de alta velocidad V-Link)• Canal doble UltraDMA-33/66/100/133 modo maestro controlador EIDE• Valor de transferencia hasta 133MB/por segundo para cubrir PIO modo 4, conductores multi-palabras DMA modo 2, e Interfaz UltraDMA-33

	<ul style="list-style-type: none"> • USB v2.0 y Interfaz de Controlador de Receptor Mejorado (EHCI) v1.0 compatible • Permite ambas ACPI (Configuración Avanzada e Interfaz de Energía) y (APM) antigua administración de energía <p>Características adicionales incluyen apoyo para seis puertos USB, un enlace AC 97 para audio y modem, monitorización de hardware, y administración de potencia ACPI/OnNow.</p>
Memoria	<ul style="list-style-type: none"> • Permite DDR hasta 200/266/333/400 MHz DDR módulo de memoria SDRAM • Adecua tres ranuras no reservadas 2.5V 184-pin • Cada ranura permite hasta 1 GB con una capacidad máxima total de 3 GB
Gráficas	<p>La SV400 incluye una ranura AGP que provee ocho tiempos de amplitud de la especificación original AGP. La AGP 3.0 (8xAGP) ofrece un aumento significativo en funcionamiento junto con características mejoradas para AGP2.0. Esta interfaz representa la evolución natural de la ya existente AGP para hacer frente a las demandas siempre en aumento centradas en las interfaces de gráficos dentro de estaciones de trabajo y ámbitos de computadoras.</p>
El Codec AC' 97 Audio	<p>El codec AC' 97 audio concuerda con la especificación de AC 97 2.2, que satisface los requisitos de PC2001 y soporta S/PDIF OUT. También tiene un buffer incorporado y PLL interno. Las características incluye soporte para interruptor analógico para la salida trasera (compartir), la clavija de entrada de línea (compartir), centro/bajo (compartir), y clavija MIC para exportar sonido de 6 canales.</p>
Opciones de Expansión	<p>SV400 tiene cinco ranuras PCI 32-bit, una ranura AGP (permite solo tarjeta 1.5V 4x AGP) y ranura CNR (Comunicaciones y Contrahuella de Red).</p> <p>La SV400 permite bus de control Ultra DMA con valor de transferencia de 33/66/100/133 MB/por segundo.</p>
LAN Incorporada (opcional)	<p>La VT6103 es un componente Estrato Físico para Ethernet 10BASE-T y 100BASE-TX usando categoría 5 no blindado, Tipo 1 Blindado, y cables de Fibra óptica.</p> <ul style="list-style-type: none"> • Velocidad Doble – 100/10 Mbps • Bidireccional Total y Medio • Reúne Todo lo Apropiado IEEE 802.3, 10Base-T y 100Base-Tx Convencionales • Ecuilizador adaptable
1394a (opcional)	<ul style="list-style-type: none"> • Controlador de interfaz VT6307 PCI 1394a incorporado • Adaptable con 1394 abierto, especificaciones HCI v1.0 y v1.1 • Permite abastecimiento de IEEE 1394-1995 convencional para bus de serie de alto rendimiento y P1394a suplemento 4.0 • Generador CRC 32 bit y verificador para recibir y transmitir datos • Adaptable con especificación PCI v2.2 • Apoyo de bus de control de alto rendimiento • Provee dos puertos de cable totalmente adaptables 1394a en 100/200/400 Mbit por segundo

I/O Integrado	<p>El tablero principal tiene un set completo de puertos de Entrada/Salida y conectores:</p> <ul style="list-style-type: none">• Dos puertos PS/2 para ratón y teclado• Un puerto de serie• Un puerto paralelo• Cuatro puertos USB• Un puerto 1394a (opcional)• Un puerto LAN (opcional)• Enchufes de audio para micrófono, línea de entrada y línea de salida
BIOS Firmware	<p>Este panel principal usa el Award BIOS que posibilita a los usuarios configurar muchas características de sistema incluidas las siguientes:</p> <ul style="list-style-type: none">• Administración de potencia• Alarmas despertadoras• Parámetros y memoria de temporizador CPU• Memoria de temporizador CPU <p>El firmware puede también ser usado para ajustar parámetros para velocidades diferentes de procesador de reloj.</p>

チェックリスト

下記のチェックリストに列挙されている製品が同封されているかを確認してください。

標準同封アイテム

- メインボード 1枚
- ディスクドライブ用リボンケーブル 1個
- IDEドライブ用リボンケーブル 1個
- 自動インストール機能対応ソフトウェアCD 1枚
- リアパネルI/Oシールド 1個
- ユーザーマニュアル

製品特徴

プロセッサ	<p>当メインボードはAMD 462ピンソケットを搭載しており、次の特長があります：</p> <ul style="list-style-type: none">● 200/266/333 MHz フロントサイドバス (FSB) をサポートします● AMD Athlon Duron、Athlon、Athlon XPプロセッサ収納可能です <hr/> <p>メモ： “Thermal Diode” 機能を正しく作動させるために、AMD Athlon XP以上、または高レベルCPUのご使用をお勧めします。</p>
チップセット	<p>SV400のチップセットには、最新且つ拡張性あるアーキテクチャを採用し、高い安定性およびパフォーマンスを兼ね備えたKT400 Northbridge及びVT8235 Southbridgeが含まれます。チップセットには次の特徴があります：</p> <ul style="list-style-type: none">● 独立したアドレス、データ、およびスヌープ・インターフェースをサポート● Athlon CPU のアドレス・バスおよびデータ・バスでの200/166/133/100 MHz DDR (Double Data Rate) 転送レートをサポート● AdおよびSBA信号の 533 MHz 8x、266 MHz 4xモード、および133 MHz 2xの転送モードをサポート● 8x 転送モードのAGP仕様v3.0に対応● 最大バンド幅533MB/秒の66MHz V-Linkホストインターフェースに対応● ホストCPU (166/133/100 MHz) のDRAMインターフェース同時期化による柔軟性の高い設定が可能● 1/10/100 Mbitの高速Ethernetコントローラを統合済み● デュアルチャンネルUltraDMA-33/66/100/133マスターモードEIDEコントローラを統合済み● PIOモード4、マルチワードDMAモード2ドライバ、UltraDMA-33インターフェースに対応するための、最高133MB/

	<p>秒転送速度</p> <ul style="list-style-type: none"> • USB v2.0及びエンハンス ホストコントローラ インターフェース (EHCI) v1.0対応 • ACPI (Advanced Configuration and Power Interface) と レガシー (APM) パワーマネジメントの両方に対応 <p>その他に、6つのUSBポート、オーディオおよびモデム向けのAC 97リンク、ハードウェアのモニタ、およびACPI/OnNow 電源管理に対応しています。</p>
メモリ	<ul style="list-style-type: none"> • 200/266/333/400 MHz DDR SDRAMまでのDDRメモリモジュールに対応 • 2つの非バッファ2.5V184ピン仕様のスロットを収納 • 各スロットが1 GBまで対応し、トータルでメモリを2 GBまでサポートします
グラフィック	<p>SV400には、本来のAGP仕様の8倍のバンド幅を提供することができる8xAGPスロットが含まれます。AGP3.0 (8xAGP) は、AGP2.0の機能をよりパワーアップしたアナログパフォーマンスを提供します。ワークステーションやデスクトップ環境において、急激に変化するグラフィックインターフェースのニーズに対応するために、既存のAGPを無理なく自然に更新することができます。</p>
AC' 97 オーディオコーデック	<p>AC' 97 オーディオコーデックはAC' 97 2.2 仕様に適合したもので、PC2001要求を満たし、S/PDIF Outに対応しています。また、内蔵バッファと内部PLLを搭載しています。このほかに、背面用アナログスイッチ (共有)、ライン入力ジャック (共有)、中央/ベース (共有)、6チャンネル出力オーディオ用MICジャックなどを備えています。</p>
拡張オプション	<p>SV400には5つの32ビットPCIスロット、APGスロット (1.5V 4x AGPカードのみ対応) とCNR (通信及びネットワーキングライザ) スロットが搭載されています。</p> <p>SV400は、33/66/100/133 MB/秒の転送速度でUltra DMAバスマスタリングに対応しています。</p>
オンボードLAN (オプション)	<p>VT6103はカテゴリ5案シールド、Type 1 シールド、光ファイバケーブルを使ったEthernet 10BASE-Tと100BASE-TXのための物理レイヤーです。</p> <ul style="list-style-type: none"> • デュアルスピード - 100/10 Mbps • 半/全二重 • すべてのIEEE 802.3、10Base-T、100Base-Tx標準に対応 • 適応エコライザ
1394a (オプション)	<ul style="list-style-type: none"> • VT6307 PCI 1394a 統合ホストコントローラ • 1394オープンHCI仕様v1.0とv1.1に対応 • 高性能シリアルバス及びP1394a 補足4.0のためのIEEE 1394-1995標準に対応 • データ送受信用の32ビットCRCジェネレータとチェッカー • PCI仕様v2.2対応 • 高性能バスマスタリング対応 • 100/200/400 Mbit/秒の1394a 完全対応ケーブルポート2つを搭載

統合の入出力ポート	<p>このメインボードにはフルセットのI/Oポートおよびコネクタが搭載しています。</p> <ul style="list-style-type: none"> ● 2つのマウスおよびキーボード向けPS/2ポート ● 2つのシリアルポート ● 1つのパラレルポート ● 4つのUSBポート ● 1つの1394aポート (オプション) ● LANポート x 1 (オプション) ● マイクロフォンやラインイン、ラインアウト向けのオーディオジャック
BIOS ファームウェア	<p>本メインボードは次のシステム機能を含めた設定をすることができるAward BIOSを採用しています：</p> <ul style="list-style-type: none"> ● 電源管理 ● Wake-up警告 ● CPUパラメータおよびメモリのタイミング ● CPUおよびメモリのタイミング <p>その他に、各種プロセッサクロック速度のパラメータを設定することができます。</p>

품목 목록

다음 품목들이 메인보드 패키지에 모두 포함되어 있는지 확인해 보십시오:

표준 품목

- 메인 보드 1개
- 디스켓 드라이브 리본 케이블 1개
- IDE 드라이브 리본 케이블 1개
- 자동 설치 소프트웨어 지원 CD 1개
- 뒷패널 I/O 실드 1개
- 리텐션 모듈 1개
- 본 사용자 설명서

기능

프로세서	<p>이 메인보드는 AMD 462 핀 소켓 A 를 사용하며 다음과 같은 특징을 지닌다:</p> <ul style="list-style-type: none"> • 200/266/333 MHz frontside bus (FSB) 지원 • AMD Duron, Athlon, Athlon XP 프로세서 사용 <hr/> <p>Note: “ 열 다이오드 ” 기능이 적절히 기능하도록 AMD Athlon XP 또는 그 이상의 CPU 사용을 권장 함.</p>
칩셋	<p>L7VTA 2의 칩셋은 KT400 Northbridge 및 VT8235 Southbridge 를 포함하며, 이는 혁신적이고 범위성을 지닌 아키텍처를 기초로 하여 인정된 신뢰성과 성능을 지닌 다. 이 칩셋이 지닌 주요 고급 특징은 다음과 같다:</p> <ul style="list-style-type: none"> • 독립 주소, 데이터, snoop 인터페이스를 지원한다 • Athlon CPU 어드레스 및 데이터 버스에서의 200/166/133/100 MHz DDR (Double Data Rate) 전송 • Ad 와 SBA 시스널링을 위한 533 MHz 8x, 266 MHz 4x, 133 MHz 2x 전송 모드 지원 • AGP v3.0의 8x 전송 모드와 호환 • 최대 대역폭 533 MB/sec 의 66 MHz V-Link 호스트 인터페이스 지원 • 가장 유연한 구성을 위한 DRAM 인터페이스와 호스트 CPU (166/133/100 MHz)의 동시성 • 1/10/100 Mbit 의 통합 패스트 이더넷 컨트롤러 • 듀얼 채널 UltraDMA-33/66/100/133 마스터 모드 EIDE 컨트롤러 • PIO 모드 4, multi-word DMA 모드 2 드라이버, UltraDMA-33 인터페이스를 커버하는 최대 전송 속도 133MB/sec • USB v2.0 및 Enhanced Host Controller Interface (EHCI) v1.0 호환

	<ul style="list-style-type: none"> ACPI (Advanced Configuration and Power Interface) 및 legacy (APM) 전원 관리 지원 <p>이외의 주요 기능으로 6 개의 USB 포트, 오디오와 모뎀을 위한 AC 97 링크와 하드웨어 모니터링 및 ACPI/OnNow 전력 관리 지원이 포함되어 있다.</p>
메모리	<ul style="list-style-type: none"> DDR 을 최대 200/266/333/400 MHz DDR SDRAM 메모리 모듈 지원 3개의 unbuffered 2.5V 184 핀 슬롯 사용 총 최대 용량은 3 GB 이며, 각 슬롯은 최대 1 GB 를 지원
그래픽	SV400 는 기존 AGP 사양의 8배의 대역폭을 제공하는 AGP 슬롯을 사용한다. AGP 3.0 (8xAGP) 는 AGP 2.0의 기능 강화로 탁월한 성능을 제공한다. 이 인터페이스는 기존 AGP의 자연적 진화로 워크 스테이션과 데스크탑 환경에서 필요로 하는 그래픽 인터페이스를 제공한다
AC' 97 오디오 코덱	AC' 97 오디오 코덱은 AC 97 2.2 사양과 호환하여 PC2001 요구 사항에 부합하며 S/PDIF In/Out을 지원한다. 버퍼 및 PLL이 내장되어 있으며, 후면-출력 (공유), 라인 입력 잭 (공유), 중앙/베이스 (공유), 및 6 채널 오디오 출력 용 MIC 잭을 위한 아날로그 스위치를 포함한다.
확장 옵션	SV400 에는 5 개의 32-bit PCI 슬롯, 1 개의 AGP 슬롯 (1.5V AGP 카드만), CNR (Communications and Networking Riser) 슬롯이 있다. SV400 는 전송 속도 33/66/100/133 MB/sec 의 Ultra DMA 버스 마스터링을 지원한다..
보드내장 LAN (선택 사항)	VT6103 는 카테고리 5 Unshielded, 타입 1 Shielded , 유리 섬유 케이블을 사용한 Ethernet 10BASE-T와 100BASE-TX 를 위한 물리적 레이어 장치이다. <ul style="list-style-type: none"> 듀얼 속도 - 100/10 Mbps Half 및 Full Duplex 모든 적용 가능한 IEEE 802.3, 10Base-T 및 100Base-Tx 표준 지원 적용 가능한 이퀄라이저
1394a (선택 사항)	<ul style="list-style-type: none"> VT6307 PCI 1394a 통합 호스트 컨트롤러 1394 open HCI 사양 v1.0 및 v1.1 호환 고 성능 시리얼 버스를 위한 IEEE 1394-1995 표준 규정 및 P1394a 증보 4.0 부합 데이터 수신 및 송신을 위한 32 bit CRC 제너레이터 및 검사기 PCI 사양 v2.2 호환 고 성능의 bus mastering 지원 매초 100/200/400 Mbit의 2 개의 1394a 호환 케이블 포트 제공
통합 I/O	메인보드는 풀 세트의 I/O 포트와 커넥터가 있다: <ul style="list-style-type: none"> 마우스와 키보드용 PS/2 포트 2 개 시리얼 포트 2개 패러럴 포트 1 개 USB 포트 4 개 1394a 포트 1 개 (선택 사항)

	<ul style="list-style-type: none"> • LAN 포트 1 개(선택 사항) • 마이크 용 오디오 잭, line-in 과 line-out
--	--

BIOS 펌웨어	<p>이 메인보드는 Award BIOS 를 사용하여 사용자는 다음과 같은 시스템 기능을 구성할 수 있다:</p> <ul style="list-style-type: none"> • 전원 관리 • 기상 알람 • CPU 파라미터 • CPU 및 메모리 타이밍 <p>펌웨어는 다른 프로세서 클럭 속도의 파라미터를 설정하는 데도 사용될 수 있다.</p>
---------------------	---

檢查表

請依下列檢查表，核對主機板包裝之內容：

標準項目

- 主機板一片
- 磁碟機排線一條
- IDE磁碟機排線一條
- 自動安裝CD一片
- 後控制面板輸出入(I/O)擋板一片
- 本使用手冊

性能

處理器	本主機板採用了具有下列功能之AMD 462針Socket A： <ul style="list-style-type: none">• 支援高達200/266/333 MHz之系統匯流排(FSB)• 支援AMD Athlon Duron, Athlon, 及 Athlon XP 處理器 <hr/> 註解： 建議使用AMD Athlon XP或更高等級之CPU, 以確保過熱保護電路(Thermal Diode)之功能運作正常。
晶片組	本SV400主機板搭載了KT400北橋 及VT8235南橋晶片組，採行了創新且具擴充性之架構，可提供您滿足之穩定性及效能。本晶片組的特點包含如下： <ul style="list-style-type: none">• 支援獨立性定址、資料及資料檢索介面• 支援高達200/166/133/100 MHz DDR (Double Data Rate, 雙倍速資料傳輸) 之Athlon CPU 位址和數據匯流排傳輸• 支援高達533 MHz 8x、266 MHz 4x、及 133 MHz 2x 的AD及邊帶定址 (SBA)信號之傳輸方式• AGP v3.0相容於8倍傳輸模式• 支援 66MHz之 V-Link 主控介面，提供高達533MB/sec之頻寬• DRAM介面與主CPU (166/133/100 MHz 傳輸速率) 同步，提供最大彈性之組態設定• 整合了快速以太網路控制器(Fast Ethernet Controller)，提供1/10/100 Mbit之連線功能• 內建雙通道UltraDMA- 33/66/100/133 主態EDIE控制器• 傳輸速率高達133MB/sec，可支援 PIO mode 4、多字元 DMA mode 2 驅動器、及 UltraDMA-33 介面• USB v2.0 及加強型主控控制器介面 (EHCI) v1.0相容• 皆支援ACPI (Advanced Configuration and Power Interface, PC97新電源管理標準) 以及舊型(APM, 先進電源管理) 之電源管理介面 其他重要功能包括：支援6個USB埠、音效及數據機連接用的

	AC 97連接埠、硬體監視功能、及ACPI/OnNow 電源管理功能。
--	-------------------------------------

記憶體	<ul style="list-style-type: none"> • 支援DDR高達200/266/333/400 MHz之DDR型SDRAM記憶體 • 配備有3無緩衝2.5V184針插槽 • 各插槽支援1GB，共可支援3GB之記憶體
AGP	本主機板SV400配備有一個AGP插槽，能夠支援為舊型AGP規格8倍之頻寬。此AGP 3.0(8xAGP) 能夠顯著增強AGP2.0之性能以及增其特色。本介面係順應工作站與個人電腦環境中對圖形介面不斷升高之要求，由既有之AGP規格所發展出來的成果。
AC' 97 音效解碼/編碼器	配備之AC' 97 音效解碼/編碼器採用了AC' 97 2.2 規格，該規格符合PC2001規格要求並支援S/PDIF輸出。同時，本解碼/編碼器也具有內建緩衝器和內裝PLL。在功能上，尚包括：支援後聲道輸出(共用)、外部音源輸入(共用)、center/bass(共用)、以及可輸出6聲道音效之麥克風接頭。
擴充 選項	SV400 配備有5個32-位元 PCI插槽、1個 AGP插槽(僅支援1.5 伏特電壓規格之4x AGP卡)及 CNR (Communications and Networking Riser) 插槽。 此外，SV400也支援Ultra DMA 匯流排主控功能，可提供33/66/100/133 MB/sec之傳輸速率。
內建網路功能 (選購)	VT6103係為乙太10BASE-T 和 100BASE-TX之實體層元件, 使用 Category 5(速率100 Mbps) 無遮蔽式雙絞線, Type 1屏蔽電纜以及光纖電纜。 <ul style="list-style-type: none"> • 雙倍速 - 100/10 Mbps 傳輸速率 • 支援半或全雙工運作模式 • 適用於所有可用之IEEE 802.3, 10BaseT和100Base-Tx雙絞線, 等之標準 • 自適均衡器
1394a(選購)	<ul style="list-style-type: none"> • VT6307 PCI 1394a 整合型主控控制器 • 符合1394 開放式 HCI 規格 v1.0 及 v1.1 • 支援 高效能串列匯流排用IEEE 1394-1995 規格及P1394a 增列規格 4.0 • 配備有32 位元 CRC 產生器及檢測器，用以收發資料 • PCI 規格 v2.2相容 • 支援高效能匯流排主控功能 • 配備有2個1394a 完全相容連線埠，提供每秒 100/200/400 M位元之傳輸效率
已整合的I/O	本主機板完整地支援各種 I輸出入及連接器： <ul style="list-style-type: none"> • 2個 PS/2 埠，分供滑鼠及鍵盤連接 • 2個串列埠 • 1個平行埠 • 4個USB埠 • 1個1394a埠(選項) • 1個LAN埠(選項) • 麥克風、line-in及line-out 音效端

BIOS 韌體	<p>本主機板使用了Award BIOS，使用者可藉此對包括下列之系統功能進行設定：</p> <ul style="list-style-type: none">• 電源管理功能• 喚醒警示功能• CPU參數• CPU及記憶體時序 <p>本BIOS也可用以設定各種有關處理器時脈的參數。</p>
----------------	--

校验表

将本主板的组件内容与以下校验表进行对照：

标准组件

- 一只主板
- 一条磁盘驱动器带状电缆
- 一条 IDE 驱动器带状电缆
- 一张自动安装软件支持光盘
- 一个后面板 I/O 防护罩
- 本用户手册

特性

处理器	主板使用一个 AMD 462-pin Socket A 插座，此插座具有以下特点： <ul style="list-style-type: none">• 支持 200/266/333 MHz 前端总线 (FSB)• 支持 AMD Duron、Athlon 和 Athlon XP 处理器 说明： 建议您使用 AMD Athlon XP 或更高频率的处理器，以确保能够正常使用“Thermal Diode”功能。
芯片组	SV400 上芯片组包括 KT400 北桥和 VT8235 南桥，它基于一种新型的、可扩展的架构，能提供已经证明的可靠性和高性能。此芯片组具有以下一些高级功能： <ul style="list-style-type: none">• 支持独立地址、数据和窥探接口• Athlon CPU 地址和数据总线上 200/166/133/100 MHz DDR (双数据传输率) 传输• Ad 和 SBA 信号传输支持 533 MHz 8x、266 MHz 4x 和 133 MHz 2x 传输模式• 8x 传输模式兼容 AGP v3.0• 支持峰值带宽为 533MB/sec 的 66MHz V-Link Host 接口• DRAM 接口 与主 CPU (166/133/100 MHz) 同步，可进行灵活配置• 集成 1/10/100 Mbit 功能的快速以太网控制器• 双通道 UltraDMA-33/66/100/133 主控模式 EIDE 控制器• 传输速率可达 133MB/sec，支持 PIO 模式 4、多字 DMA 模式 2 驱动程序和 UltraDMA-33 接口• 兼容 USB v2.0 和增强主控器接口 (EHCI) v1.0• 支持 ACPI (高级配置电源接口) 和传统 (APM) 电源管理 其它功能包括支持 6 个 USB 端口、用于音频和调制解调器的 AC 97 连接、硬件监测和 ACPI/OnNow 电源管理。
内存	<ul style="list-style-type: none">• 支持 200/266/333/400MHz DDR SDRAM 内存条

	<ul style="list-style-type: none"> • 它有 3 个非缓冲 2.5V 184 pin 插槽 • 每个插槽支持 1 GB, 总共最大可支持 3 GB
AGP	SV400 包括一个 8xAGP 插槽, 可提供普通 AGP 规格 8 倍的带宽。AGP 3.0 (8xAGP) 在增强了 AGP2.0 功能的同时极大地提高了性能。此接口反映了 AGP 的发展规律, 它进一步满足了在工作站和桌面环境中对图形接口的不断增长的要求。
AC' 97 Audio Codec	AC' 97 音频编解码器符合 AC 97 2.2 PC2001 规格, 支持 S/PDIF Out。它还带有一个内置的缓冲器和一个内部 PLL。功能包括支持后端模拟开关 (共享)、线入插孔 (共享)、中置/低音 (共享) 和 MIC 插孔以输出 6 声道音频。
扩展选项	SV400 具有 5 个 32 位 PCI 插槽、1 个 AGP (仅支持 1.5V 4x AGP 卡) 插槽和 1 个 CNR (通信网络转接) 插槽。 SV400 支持 Ultra DMA 总线控制, 传输速率可达 33/66/100/133 MB/sec。
Onboard LAN (可选)	VT6103 是一种物理层设备, 可用于使用 5 类非屏蔽线、1 类屏蔽线和光缆的以太网 10BASE-T 和 100BASE-TX。 <ul style="list-style-type: none"> • 双速 -100/10 Mbps • 半双工和全双工 • 符合所有相应的 IEEE 802.3、10Base-T 和 100Base-Tx 标准 • 自适应均衡器
1394a (可选)	<ul style="list-style-type: none"> • VT6307 PCI 1394a 集成主控制器 • 兼容 1394 open HCI v1.0 和 v1.1 规格 • 支持 IEEE 1394-1995 标准中对高性能串行总线的规定和 P1394a 附录 4.0 • 32 位 CRC 发生器和检查器用于接收和传输数据 • 兼容 PCI v2.2 规格 • 支持高性能总线主控 • 提供 2 个 1394a 全兼容的电缆端口, 传输速率达 100/200/400 Mbit/秒
集成 I/O	此主板具有完整的 I/O 端口和插孔: <ul style="list-style-type: none"> • 2 个 PS/2 端口用于连接鼠标和键盘 • 2 个串口 • 1 个并口 • 4 个 USB 端口 • 1 个 1394a 端口 (可选) • 1 个 LAN 端口 (可选) • 麦克风、线入和线出声音插孔)
BIOS	此主板使用 Award BIOS, 可以让用户自己配置以下系统功能: <ul style="list-style-type: none"> • 电源管理 • 唤醒报警 • CPU 参数 • CPU 和记忆定时 还可用于设置不同处理器时钟速度的参数。

TABLE OF CONTENTS

Preface	i
Features and Packing List Translations	iii
CHAPTER 1	1
Introducing the Mainboard	1
<i>Introduction</i>	1
<i>Checklist</i>	1
Standard Items	1
<i>Features</i>	2
<i>Choosing a Computer Case</i>	4
<i>Mainboard Components</i>	5
CHAPTER 2	7
Installing the Mainboard	7
<i>Safety Precautions</i>	7
<i>Quick Guide</i>	7
<i>Installing the Mainboard in a Case</i>	8
<i>Checking Jumper Settings</i>	8
Setting Jumpers	8
Checking Jumper Settings	9
Jumper Settings	9
Connecting Case Components	10
Front Panel Connector	12
<i>Installing Hardware</i>	13
Installing the Processor	13
Installing Memory Modules	15
Installing a Hard Disk Drive/CD-ROM	16
Installing a Floppy Diskette Drive	18
Installing Add-on Cards	19
Connecting Optional Devices	21
<i>Connecting I/O Devices</i>	23
External Connector Color Coding	24
CHAPTER 3	25
Using BIOS	25
<i>About the Setup Utility</i>	25
The Standard Configuration	25

Starting Setup	26
Updating the BIOS	27
<i>Using BIOS</i>	28
Standard CMOS Features	28
Advanced BIOS Setup	30
Advanced Chipset Setup	33
Integrated Peripherals	37
Power Management Setup	42
PNP/PCI Configurations	46
PC Health Status	47
Frequency/Voltage Control	48
Load Fail-Safe Defaults	49
Load Optimized Defaults	49
Set Supervisor/User Password	49
Save & Exit Setup	50
Exit Without Saving	50

CHAPTER 4 **51**

Using the Mainboard Software	51
<i>About the Software CD-ROM</i>	51
<i>Auto-installing under Windows 98/ME/2000/XP</i>	51
Running Setup	52
<i>Manual Installation</i>	54
<i>Utility Software Reference</i>	54

Chapter 1

Introducing the Mainboard

Introduction

Thank you for choosing the SV400 mainboard. The SV400 is designed to fit the advanced AMD processors in the 462-pin package. Based on the ATX form factor featuring the VIA KT400 Northbridge and VT8235 Southbridge chipsets. This mainboard provides the standard 100/133/166MHz front side bus with extra capability.

The Apollo KT400 chipset consists of the KT400 Northbridge and VT8235 Southbridge. The KT400 Northbridge provides superior performance between the CPU, DRAM, AGP bus, and 8X V-Link bus with pipelined, burst, and concurrent operation. It supports eight banks of DDR Synchronous DRAMs up to 4 GB for registered modules and full AGP 3.0 capability bus utilization including 2x, 4x, and 8x mode transfers, SideBand Addressing, Flush/Fence commands and pipelined grants.

The VT8235 Southbridge supports standard intelligent peripheral controllers such as USB v2.0/1.1 and Universal HCI v2.0/1.1 compliant, real time clock with 256 byte extended CMOS, integrated bus-mastering dual full-duplex direct-sound AC97 link compatible sound system and full System Management Bus (SMBus) interface.

The SV400 is equipped with advanced full set of I/O ports, such as dual channel IDE interfaces, a floppy controller, two high-speed serial port, an EPP/ECP capable bi-directional parallel port connector, four USB (Universal Serial Bus) connector, a PS/2 keyboard, mouse and 1394a connectors. One AGP slot, five PCI local bus slots and one communication and networking riser (CNR) slot provide expandability for add-on peripheral cards.

Checklist

Compare the mainboard's package contents with the following checklist:

Standard Items

- One mainboard
- One diskette drive ribbon cable
- One IDE drive ribbon cable
- One auto-install software support CD
- One I/O shield
- This user's manual

Features

Processor	<p>The mainboard uses an AMD 462-pin Socket A that has the following features:</p> <ul style="list-style-type: none"> • Supports 200/266/333 MHz frontside bus (FSB) • Accommodates AMD Duron, Athlon, and Athlon XP processors <hr/> <p>Note: It is recommended that you use AMD Athlon XP or higher level CPU to make sure that the “Thermal Diode” function will work properly.</p>
Chipset	<p>The chipset on SV400 includes the KT400 Northbridge and VT8235 Southbridge which are based on an innovative and scalable architecture with proven reliability and performance. A few of the chipset’s advanced features are:</p> <ul style="list-style-type: none"> • Support independent address, data, and snoop interfaces • 200/166/133/100 MHz DDR (Double Data Rate) transfer on Athlon CPU address and data buses • Support 533 MHz 8x, 266 MHz 4x, and 133 MHz 2x transfer modes for Ad and SBA signaling • AGP v3.0 compliant with 8x transfer mode • Supports 66 MHz V-Link Host interface with peak bandwidth of 533 MB/sec • DRAM interface synchronous with host CPU (166/133/100 MHz) for most flexible configuration • Integrated Fast Ethernet Controller with 1/10/100 Mbit capability • Dual channel UltraDMA-33/66/100/133 master mode EIDE controller • Transfer rate up to 133MB/sec to cover PIO mode 4, multi-word DMA mode 2 drivers, and UltraDMA-33 interface • USB v2.0 and Enhanced Host Controller Interface (EHCI) v1.0 compatible • Supports both ACPI (Advanced Configuration and Power Interface) and legacy (APM) power management <p>Additional features include support for six USB ports, an AC 97 link for audio and modem, hardware monitoring, and ACPI/OnNow power management.</p>
Memory	<ul style="list-style-type: none"> • Supports DDR up to 200/266/333/400 (enhanced) MHz DDR SDRAM memory module • Accommodates three unbuffered 2.5V 184-pin slots • Each slot supports up to 1 GB with a total maximum capacity of 3 GB
Graphics	<p>The SV400 includes an AGP slot that provides eight times the bandwidth of the original AGP specification. The AGP 3.0 (8xAGP) offers a significant increase in performance along with feature enhancements to AGP2.0. This interface represents the natural evolution from the existing AGP to meet the ever-increasing demands placed on the graphic interfaces within the workstation and desktop environments.</p>

AC' 97 Audio Codec	The AC' 97 Audio codec is compliant with the AC 97 2.2 specification that meets the PC2001 requirements and supports S/PDIF Out. It also has a built-in buffer and internal PLL. Features include support for analog switch for rear-out (share), the line-in jack (share), center/bass (share), and MIC jack to output 6 channels audio.
Expansion Options	SV400 has five 32-bit PCI slots, an AGP slot (supports 1.5V AGP card only) and CNR (Communications and Networking Riser) slot. The SV400 supports Ultra DMA bus mastering with transfer rates of 33/66/100/133 MB/sec.
Onboard LAN (optional)	The VT6103 is a Physical Layer device for Ethernet 10BASE-T and 100BASE-TX using category 5 Unshielded, Type 1 Shielded, and Fiber Optic cables. <ul style="list-style-type: none"> • Dual Speed – 100/10 Mbps • Half And Full Duplex • Meet All Applicable IEEE 802.3, 10Base-T and 100Base-Tx Standards • Adaptive Equalizer
1394a (optional)	<ul style="list-style-type: none"> • VT6307 PCI 1394a integrated host controller • Compliant with 1394 open HCI specifications v1.0 and v1.1 • Supports provisions of IEEE 1394-1995 standard for high performance serial bus and the P1394a supplement 4.0 • 32 bit CRC generator and checker for receive and transmit data • Compliant with PCI specification v2.2 • High-performance bus mastering support • Provides two 1394a fully compliant cable ports at 100/200/400 Mbit per second
Integrated I/O	The mainboard has a full set of I/O ports and connectors: <ul style="list-style-type: none"> • Two PS/2 ports for mouse and keyboard • Two serial port • One parallel port • Four USB ports • One 1394a port (optional) • One LAN port (optional) • Audio jacks for microphone, line-in and line-out
BIOS Firmware	This mainboard uses Award BIOS that enables users to configure many system features including the following: <ul style="list-style-type: none"> • Power management • Wake-up alarms • CPU parameters • CPU and memory timing The firmware can also be used to set parameters for different processor clock speeds.

Choosing a Computer Case

There are many types of computer cases on the market. The mainboard complies with the specifications for the ATX system case. Some features on the mainboard are implemented by cabling connectors on the mainboard to indicators and switches on the system case. Ensure that your case supports all the features required. The mainboard can support one or two floppy diskette drives and four enhanced IDE drives. Ensure that your case has sufficient power and space for all the drives that you intend to install.

Most cases have a choice of I/O templates in the rear panel. Make sure that the I/O template in the case matches the I/O ports installed on the rear edge of the mainboard.

This mainboard has an ATX form factor of 305 mm x 190 mm. Choose a case that accommodates this form factor.

Mainboard Components

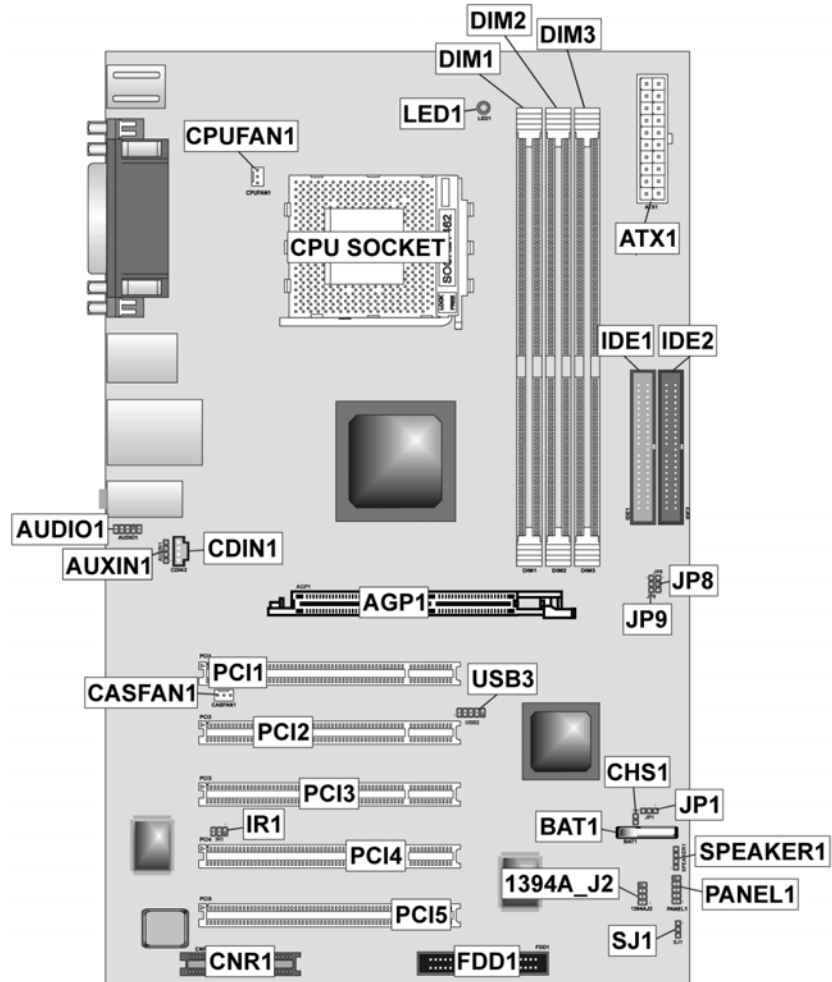

Table of Mainboard Components

Label	Component
1394A_J2	IEEE 1394A header
AGP1	Accelerated Graphics Port (supports 1.5V AGP card only)
ATX1	Standard 20-pin ATX power connector
AUDIO1	Front audio connector
AUXIN1	Extra line-in connector
BAT1	Three volt realtime clock battery
CASFAN1	Case fan connector
CDIN1	CD-in connector
CHS1	Chassis Intrusion Detect
CNR1	Communications Networking Riser slot
CPU SOCKET	Socket A for AMD Athlon/Duron CPUs
CPUFAN1	Cooling fan for CPU
DIM1 ~ DIM3	Three 184-pin DDR SDRAM
FDD1	Floppy disk drive connector
IDE 1	Primary IDE channel
IDE 2	Secondary IDE channel
IR1	Infrared port
JP1	Clear CMOS jumper
JP8 ~ JP9	CPU Frequency jumper
LED1 ¹	Memory module LED
PANEL1	Connector for case front panel switches and LED indicators
PCI1 ~ PCI5	Five 32-bit add-on card slots
SJ1	Single color LED header
SPEAKER1	Speaker connector
USB3	Connector for front panel USB ports

This concludes Chapter 1. The next chapter explains how to install the mainboard.

¹ The red indicator LED1 turns on if your system is still powered, at which time memory modules cannot be installed or uninstalled.

Chapter 2

Installing the Mainboard

Safety Precautions

Follow these safety precautions when installing the mainboard:

- Wear a grounding strap attached to a grounded device to avoid damage from static electricity.
- Discharge static electricity by touching the metal case of a safely grounded object before working on the mainboard.
- Leave components in the static-proof bags they came in.
- Hold all circuit boards by the edges. Do not bend circuit boards.

Quick Guide

This Quick Guide suggests the steps you can take to assemble your system with the mainboards.

The following table provides a reference for installing specific components:

Locating Mainboard Components	Go to page 5
Installing the Mainboard in a Case	Go to page 8
Setting Jumpers	Go to page 8
Installing Case Components	Go to page 10
Installing the CPU	Go to page 13
Installing Memory	Go to page 15
Installing an HDD and CD-ROM Drive	Go to page 16
Installing an FDD	Go to page 18
Installing Add-on Cards	Go to page 19
Connecting Options	Go to page 21
Connecting Peripheral (I/O) Devices	Go to page 23

Installing the Mainboard in a Case

Refer to the following illustration and instructions for installing the mainboard in a case:

This illustration shows an example of a mainboard being installed in a tower-type case:

Note: Do not overtighten the screws as this can stress the mainboard.

Most system cases have mounting brackets installed in the case, which correspond to the holes in the mainboard. Place the mainboard over the mounting brackets and secure the mainboard onto the mounting brackets with screws.

2. Secure the mainboard with screws where appropriate.

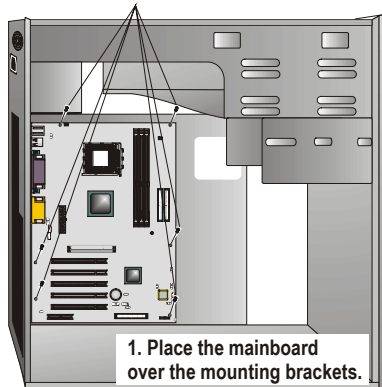

Ensure that your case has an I/O template that supports the I/O ports and expansion slots on your mainboard.

Checking Jumper Settings

This section explains how to set jumpers for correct configuration of the mainboard.

Setting Jumpers

Use the mainboard jumpers to set system configuration options. Jumpers with more than one pin are numbered. When setting the jumpers, ensure that the jumper caps are placed on the correct pins.

The illustrations below show a 2-pin jumper. When the jumper cap is placed on both pins, the jumper is **SHORT**. If you remove the jumper cap, or place the jumper cap on just one pin, the jumper is **OPEN**.

This illustration shows a 3-pin jumper. Pins 1 and 2 are **SHORT**.

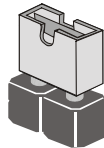

Short

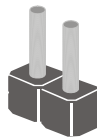

Open

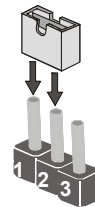

Checking Jumper Settings

The following illustration shows the location of the mainboard jumpers. Pin 1 is labeled.

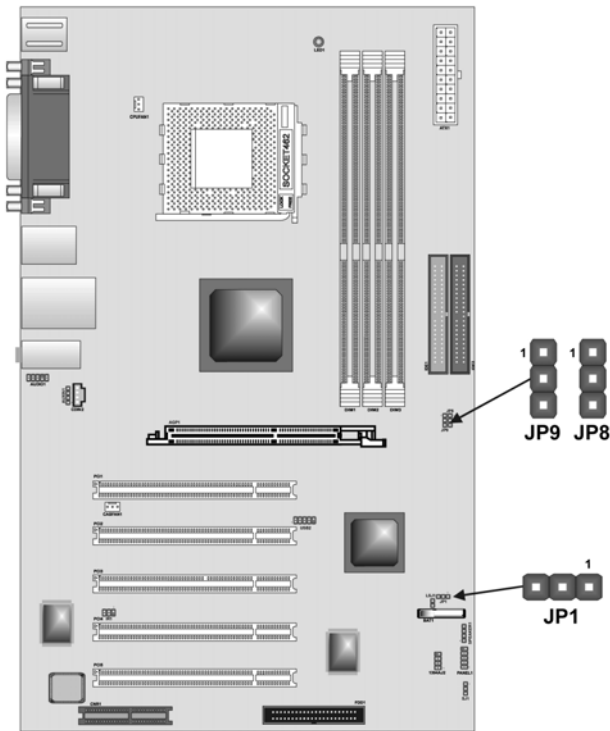

Jumper Settings

Jumper	Type	Description	Setting (default)
JP1	3-pin	Clear CMOS	1-2: Normal 2-3: <i>Clear CMOS</i>
JP8 & JP9	3-pin	CPU Frequency select jumper	See table on following page for settings.

JP1 – Clear CMOS Jumper

Use this jumper to clear the contents of the CMOS memory. You may need to clear the CMOS memory if the settings in the Setup Utility are incorrect and prevent your mainboard from operating. To clear the CMOS memory, disconnect all the power cables from the mainboard and then move the jumper cap into the CLEAR setting for a few seconds.

JP9 & JP8 – CPU Frequency Select Jumper

This jumper enables you to set the CPU frequency.

JP8	JP9	CPU Frequency
Short 1-2	Short 1-2	100MHz
Short 2-3	Short 1-2	133MHz
Short 1-2	Short 2-3	Not Applicable
Short 2-3	Short 2-3	166MHz

Connecting Case Components

After you have installed the mainboard into a case, you can begin connecting the mainboard components. Refer to the following:

<ol style="list-style-type: none"> 1. Connect the CPU cooling fan cable to CPUFAN1. 2. Connect the case cooling fan connector to CASFAN1. 3. Connect the case speaker cable to SPEAKER1. 4. Connect the case LED cable to SJ1/LSJ1. 5. Connect the case switches and indicator to PANEL1. 6. Connect the standard power supply connector to ATX1. 7. If your case has a case open alarm cable, connect it to CHS1. 	
--	--

ATX1: ATX 20-pin Power Connector

Pin	Signal Name	Pin	Signal Name
1	+3.3V	11	+3.3V
2	+3.3V	12	-12V
3	Ground	13	Ground
4	+5V	14	PS ON#
5	Ground	15	Ground
6	+5V	16	Ground
7	Ground	17	Ground
8	PWRGD	18	+5V
9	+5VSB	19	+5V
10	+12V	20	+5V

CPUFAN1/CASFAN1: FAN Power Connectors

Pin	Signal Name	Function
1	GND	System Ground
2	+12V	Power +12V
3	Sense	Sensor

SPEAKER1: Internal speaker

Pin	Signal Name
1	Signal
2	NC
3	Ground NC?
4	VCC

CHS1: Chassis Intrusion Detect

This connector allows the user to detect unauthorized intrusion to the case. It will alert the user with a warning message when the case is turned on.

Pin	Signal Name	Function
1	Intruder	Case open detecting signal
2	GND	Ground

SJ1: Single-color LED header

Pin	Signal Name
1	ACPI LED
2	ACPI LED
3	5VSB

ACPI LED function:

 SJ1	S0	S1	S3	S4/S5
	Light	Blinking	Blinking	Dark

Front Panel Connector

The front panel connector (PANEL1) provides a standard set of switch and LED connectors commonly found on ATX or micro-ATX cases. Refer to the table below for information:

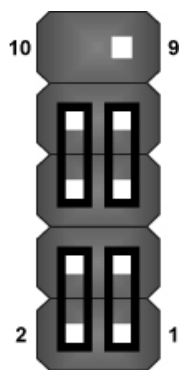

PANEL1

Pin	Function	Pin	Function
1	Hard disk LED (positive)	2	MSG LED [dual color or single color (+)]
3	Hard disk active LED (negative)	4	MSG LED [dual color or single color (-)]
5	Reset Switch	6	Power Switch
7	Reset Switch	8	Power Switch
9	Reserved	10	No pin

Hard Drive Activity LED

Connecting pins 1 and 3 to a front panel mounted LED provides visual indication that data is being read from or written to the hard drive. For the LED to function properly, an IDE drive should be connected to the onboard IDE interface. The LED will also show activity for devices connected to the SCSI (hard drive activity LED) connector.

Power / Sleep / Message Waiting LED

Connecting pins 2 and 4 to a single- or dual-color, front panel mounted LED provides power on/off, sleep, and message waiting indication.

Reset Switch

Supporting the reset function requires connecting pins 5 and 7 to a momentary-contact switch that is normally open. When the switch is closed, the board resets and runs POST.

Power Switch

Supporting the power on/off function requires connecting pins 6 and 8 to a momentary-contact switch that is normally open. The switch should maintain contact for at least 50 ms to signal the power supply to switch on or off. The time requirement is due to internal debounce circuitry. After receiving a power on/off signal, at least two seconds elapses before the power supply recognizes another on/off signal.

Installing Hardware

Installing the Processor

Caution: When installing a CPU heatsink and cooling fan make sure that you **DO NOT** scratch the mainboard or any of the surface-mount resistors with the clip of the cooling fan. If the clip of the cooling fan scrapes across the mainboard, you may cause serious damage to the mainboard or its components.

On most mainboards, there are small surface-mount resistors near the processor socket, which may be damaged if the cooling fan is carelessly installed.

Avoid using cooling fans with sharp edges on the fan casing and the clips. Also, install the cooling fan in a well-lit work area so that you can clearly see the mainboard and processor socket.

Before installing the Processor

This mainboard automatically determines the CPU clock frequency and system bus frequency for the processor. You may be able to change these settings by making changes to jumpers on the mainboard, or changing the settings in the system Setup Utility. We strongly recommend that you do not overclock processors or other components to run faster than their rated speed.

Warning: Overclocking components can adversely affect the reliability of the system and introduce errors into your system. Overclocking can permanently damage the mainboard by generating excess heat in components that are run beyond the rated limits.

This mainboard has a Socket 462 processor socket. When choosing a processor, consider the performance requirements of the system. Performance is based on the processor design, the clock speed and system bus frequency of the processor, and the quantity of internal cache memory and external cache memory.

CPU Installation Procedure

The following illustration shows CPU installation components:

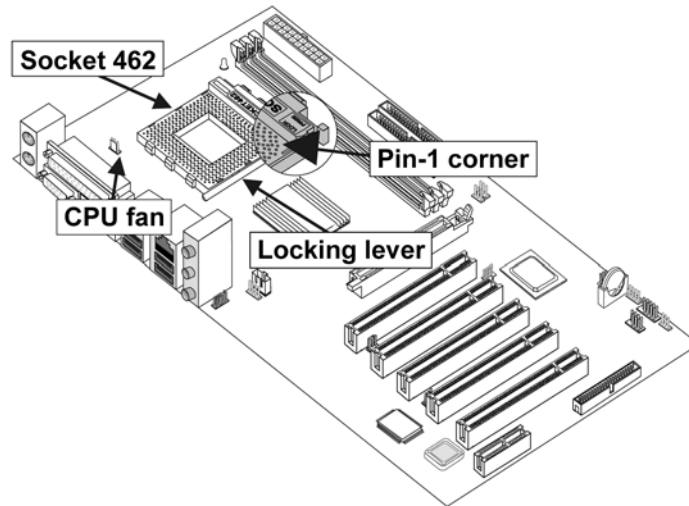

Note: The pin-1 corner is marked with an arrow ▼

Follow these instructions to install the CPU:

- | | |
|----|---|
| 1. | Pull the CPU socket locking lever away from the socket to unhook it and raise the locking lever to the upright position. |
| 2. | Match the corner on the CPU marked with an arrow with pin A-1 on the CPU socket (the corner with the pinhole noticeably missing). Insert the processor into the socket. Do not use force. |
| 3. | Swing the locking lever down and hook it under the latch on the edge of the socket. |
| 4. | Apply thermal grease to the top of the CPU. |
| 5. | Lower the CPU cooling fan/heatsink assembly onto the CPU |
| 6. | Secure the two retention clips on either side of the fan/heatsink unit onto the Socket 462 base. |

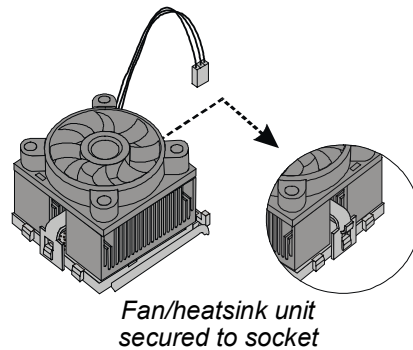

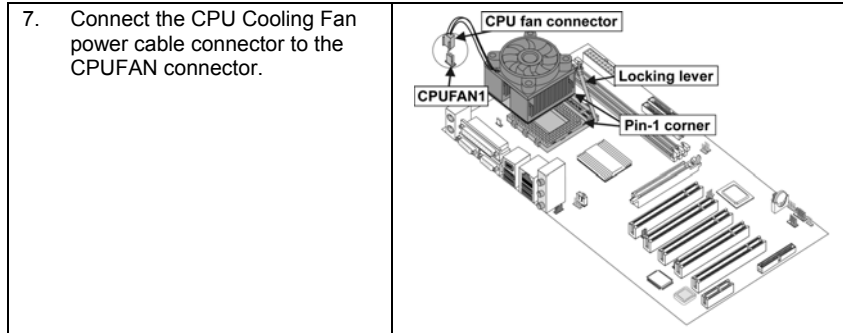

- Notes:**
- To achieve better airflow rates and heat dissipation, we suggest that you use a high quality fan with 4800 rpm at least.
 - CPU fan and heatsink installation procedures may vary with the type of CPU fan/heatsink supplied. The form and size of fan/heatsink may also vary.

Installing Memory Modules

This mainboard accommodates three 184-pin 2.5V unbuffered Double Data Rate (DDR) SDRAM memory modules. When you installed DDR266 memory modules, the memory bus can run up to 133 MHz. If you have DDR200, this can only run up to 100 MHz.

Note: SDRAM provides 800 MBps or 1 GBps data transfer depending on whether the bus is 100MHz or 133MHz. Double Data Rate SDRAM (DDR SDRAM) doubles the rate to 1.6 GBps and 2.1 GBps. DDR SDRAM uses additional power and ground lines and requires 184-pin DIMM modules rather than the 168-pin DIMMs used by SDRAM.

The mainboard accommodates three memory modules. You must install at least one module in any of the three slots. Each module can be installed with 32 MB to 1 GB of memory; total memory capacity is 3GB.



Do not remove any memory module from its antistatic packaging until you are ready to install it on the mainboard. Handle the modules only by their edges. Do not touch the components or metal parts. Always wear a grounding strap when you handle the modules.

Installation Procedure

Refer to the following to install the memory modules.

1. This mainboard supports unbuffered DDR SDRAM only. Do not attempt to insert any other type of DDR SDRAM into the slots.



2. Push the latches on each side of the DIMM slot down.

- Align the memory module with the slot. The DIMM slots are keyed with notches and the DIMMs are keyed with cutouts so that they can only be installed correctly.

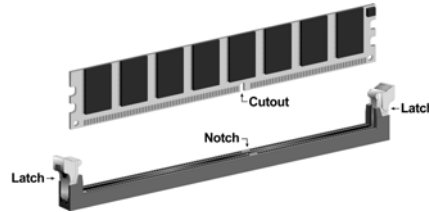

- Check that the cutouts on the DIMM module edge connector match the notches in the DIMM slot.

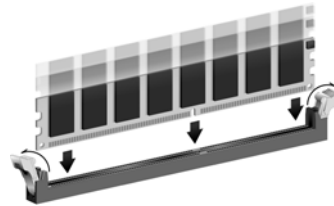

- Install the DIMM module into the slot and press it firmly down until it seats correctly. The slot latches are levered upwards and latch on to the edges of the DIMM.

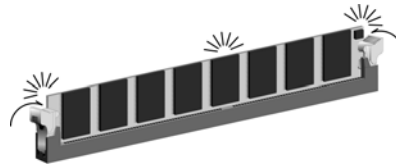

- Install any remaining DIMM modules.

DDR SDRAM memory module table:

DDR 266	3 DIMMs
DDR 333	3 DIMMs
DDR 400	DDR 400 can only support up to <u>2</u> DIMMs: 1. One <i>double-sided</i> DIMM (or) 2. Two <i>single-sided</i> DIMMs

Note: We do not guarantee that all DDR 400 memory modules will work properly with your mainboard.

Installing a Hard Disk Drive/CD-ROM

This section describes how to install IDE devices such as a hard disk drive and a CD-ROM drive.

About IDE1 and IDE2 Devices

Your mainboard has a primary and secondary IDE channel interface (IDE1 and IDE2). An IDE ribbon cable supporting two IDE devices is bundled with the mainboard.

If you want to install more than two IDE devices, get a second IDE cable and you can add two more devices to the secondary IDE channel.

IDE devices have jumpers or switches that are used to set the IDE device as MASTER or SLAVE. Refer to the IDE device user's manual. When installing two IDE devices on one cable, ensure that one device is set to MASTER and the

other device is set to SLAVE. The documentation of your IDE device explains how to do this.

About UltraDMA

This mainboard supports UltraDMA 66/100/133. UDMA is a technology that accelerates the performance of devices in the IDE channel. To maximize performance, install IDE devices that support UDMA and use 80-pin IDE cables that support UDMA 66/100/133.

Installing a Hard Disk Drive

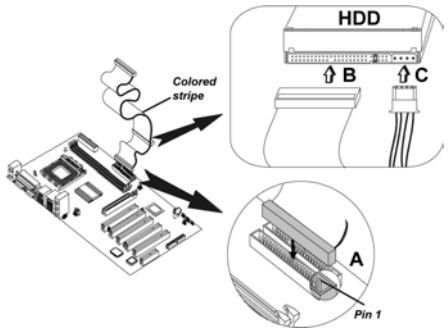
<p>1. Install the hard disk drive into the drive cage in your system case.</p> <p>2. Plug the IDE cable into IDE1 (A):</p> <p>Note: Ribbon cable connectors are usually keyed so that they can only be installed correctly on the device connector. If the connector is not keyed, make sure that you match the pin-1 side of the cable connector with the pin-1 side of the device connector. Each connector has the pin-1 side clearly marked. The pin-1 side of each ribbon cable is always marked with a colored stripe on the cable.</p>	
<p>3. Plug an IDE cable connector into the hard disk drive IDE connector (B). It doesn't matter which connector on the cable you use.</p>	
<p>4. Plug a power cable from the case power supply into the power connector on the hard disk drive (C).</p>	

When you first start up your system, the BIOS should automatically detect your hard disk drive. If it doesn't, enter the Setup Utility and use the IDE Hard Disk Auto Detect feature to configure the hard disk drive that you have installed. See IDE HDD Auto-Detection on page 29 for more information.

Installing a CD-ROM/DVD Drive

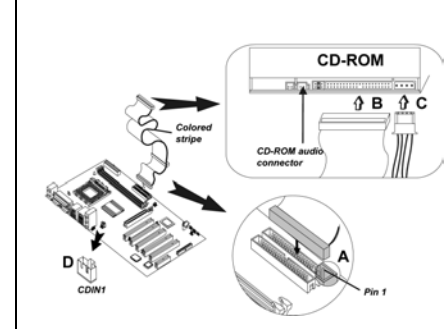
<p>1. Install the CD-ROM/DVD drive into the drive cage in your system case.</p> <p>2. Plug the IDE cable into IDE1 (A). If you have already installed an HDD, use the other connector on the IDE cable.</p> <p>Note: Ribbon cable connectors are usually keyed so that they can only be installed correctly on the device connector. If the connector is not keyed, make sure that you match the pin-1 side of the cable connector with the pin-1 side of the device connector. Each connector has the pin-1 side clearly marked. The pin-1 side of each ribbon cable is always marked with a colored stripe on the</p>	
--	--

cable.	
3.	Plug an IDE cable connector into the CD-ROM/DVD drive IDE connector (B). It doesn't matter which connector on the cable you use.
4.	Plug a power cable from the case power supply into the power connector on the CD-ROM/DVD drive (C).
5.	Use the audio cable provided with the CD-ROM/DVD drive to connect to the mainboard CD-in connector CDIN1 (D).

When you first start up your system, the BIOS should automatically detect your CD-ROM/DVD drive. If it doesn't, enter the Setup Utility and configure the CD-ROM/DVD drive that you have installed. See IDE Primary/Secondary Master/Slave on page 29 for more information.

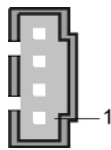

CDIN1

Pin	Signal Name
1	CD IN L
2	GND
3	GND
4	CD IN R

Installing a Floppy Diskette Drive

The mainboard has a floppy diskette drive (FDD) interface and ships with a diskette drive ribbon cable that supports one or two floppy diskette drives. You can install a 5.25-inch drive and a 3.5-inch drive with various capacities. The floppy diskette drive cable has one type of connector for a 5.25-inch drive and another type of connector for a 3.5-inch drive.

1.	Install the FDD into the drive cage in your system case.	
2.	Plug the FDD cable into FLOPPY1 (A): Note: Ribbon cable connectors are usually keyed so that they can only be installed correctly on the device connector. If the connector is not keyed, make sure that you match the pin-1 side of the cable connector with the pin-1 side of the device connector. Each connector has the pin-1 side clearly marked. The pin-1 side of each ribbon cable is always marked with a colored stripe on the cable.	
3.	Plug the correct connector on the FDD cable for the 5.25-inch or 3.5-inch drive into the FDD connector (B).	
4.	Plug a power cable from the case power supply into the power connector on the FDD (C).	

When you first start up your system, go immediately to the Setup Utility to configure the floppy diskette drives that you have installed.

Installing Add-on Cards

The slots in this mainboard are designed to hold expansion cards and connect them to the system bus. Expansion slots are a means of adding or enhancing the mainboard's features and capabilities. With these efficient facilities, you can increase the mainboard's capabilities by adding hardware which performs tasks that are not part of the basic system.

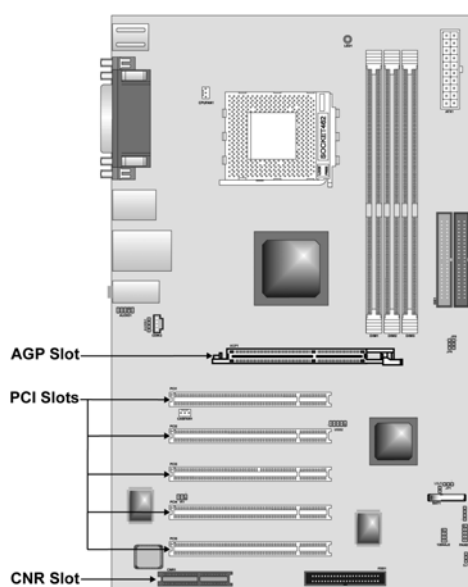

- PCI Slots** PCI slots are used to install expansion cards that have the 32-bit PCI interface.
- AGP Slot** The AGP slot is use to install graphics adapter that supports the 1.5V 8x AGP card which is also backward compatible with 4x AGP card. The slot is keyed to support only the latest 1.5-volt AGP cards.
-
- Note:** The above layout is for reference only. The AGP slot may be different from your mainboard. Please refer to actual shipment.
-
- CNR Slot** This slot is used to insert CNR cards with Modem and Audio functionality.
-
- Note:** Before installing an add-on card, check the documentation for the card carefully. If the card is not Plug and Play, you may have to manually configure the card before installation.
-

Follow these instructions to install an add-on card:

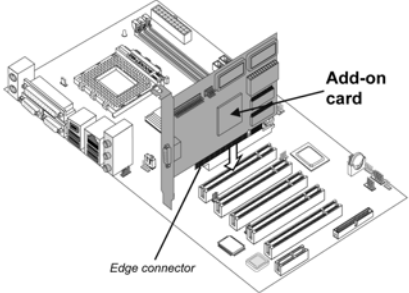
1. Remove a blanking plate from the system case corresponding to the slot you are going to use.	
2. Install the edge connector of the add-on card into the expansion slot. Ensure that the edge connector is correctly seated in the slot.	 An exploded view diagram of a motherboard expansion slot. An add-on card is shown being inserted into the slot. A label 'Add-on card' points to the card, and a label 'Edge connector' points to the gold-plated contacts on the card's edge. The diagram also shows the metal bracket of the card and a screw used for mounting.
3. Secure the metal bracket of the card to the system case with a screw.	

Note: For some add-on cards, for example graphics adapters and network adapters, you have to install drivers and software before you can begin using the add-on card.

Connecting Optional Devices

Refer to the following for information on connecting the mainboard's optional devices:

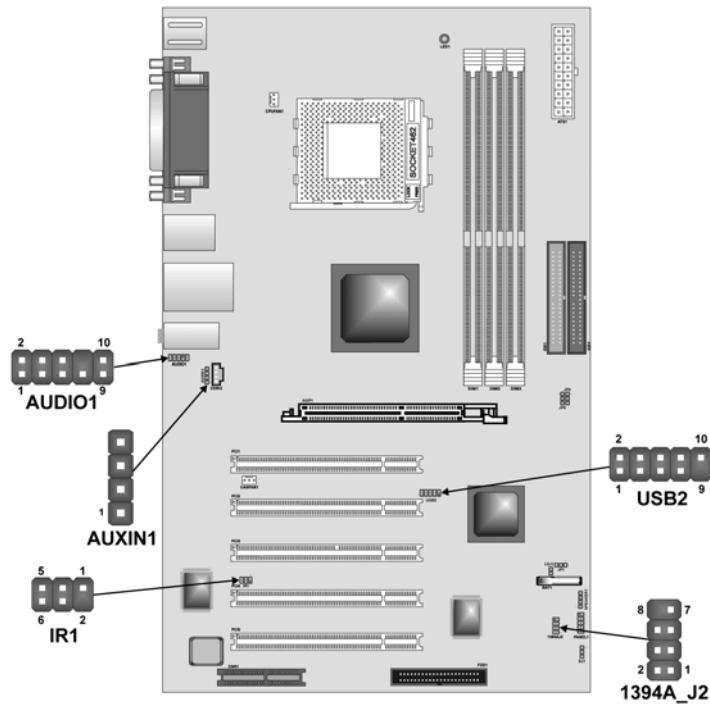

AUDIO1: Front Panel Audio header

This header allows the user to install auxiliary front-oriented microphone and line-out ports for easier access.

Pin	Signal Name	Function
1	AUD_MIC	Front Panel Microphone input signal
2	AUD_GND	Ground used by Analog Audio Circuits
3	AUD_MIC_BIAS	Microphone Power
4	AUD_VCC	Filtered +5 V used by Analog Audio Circuits
5	AUD_FPOUT_R	Right Channel Audio signal to Front Panel
6	AUD_RET_R	Right Channel Audio signal to Return from Front Panel
7	HP_ON	Reserved for future use to control Headphone Amplifier
8	KEY	No Pin
9	AUD_FPOUT_L	Left Channel Audio signal to Front Panel
10	AUD_RET_L	Left Channel Audio signal Return from Front Panel

AUXIN1: Extra line-in connector

This connector is an additional line-in audio connector. It allows you to attach a line-in cable when your rear line-in jack is set as line out port for 4-channel function.

Pin	Signal Name	Function
1	AUX_L	AUX In left channel
2	GND	Ground
3	GND	Ground
4	AUX_R	AUX In right channel

USB2: Front Panel USB connector

The mainboard has four USB ports installed on the rear edge I/O port array. Additionally, some computer cases have USB ports at the front of the case. If you have this kind of case, use auxiliary USB connector USB2 to connect the front-mounted ports to the mainboard.

Pin	Signal Name	Function
1	VREG_FP_USBPWR0	Front Panel USB Power
2	VREG_FP_USBPWR0	Front Panel USB Power
3	USB_FP_P0-	USB Port 0 Negative Signal
4	USB_FP_P1-	USB Port 1 Negative Signal
5	USB_FP_P0+	USB Port 0 Positive Signal
6	USB_FP_P1+	USB Port 1 Positive Signal
7	GND	Ground
8	GND	Ground
9	KEY	No pin
10	USB_FP_OC0	Overcurrent signal

Note: Please make sure that the USB cable has the same pin assignment as indicated above. A different pin assignment may cause damage or system hang-up.

IR1: Serial infrared port

The mainboard supports an Infrared (IR1) data port. Infrared ports allow the wireless exchange of information between your computer and similarly equipped devices such as printers, laptops, Personal Digital Assistants (PDAs), and other computers.

Pin	Signal Name	Function
1	Not assigned	Not assigned
2	KEY	No pin
3	+5V	IR Power
4	GND	Ground
5	IRTX	IrDA serial output
6	IRRX	IrDA serial input

1394A_J2: IEEE 1394A header

Use this header to connect to any IEEE 1394A interface.

Pin	Signal Name	Pin	Signal Name
1	Cable-power	5	TPA-
2	GND	6	TPA+
3	TPB-	7	Chassis GND
4	TPB+	8	NC

Connecting I/O Devices

The backplane of the mainboard has the following I/O ports:

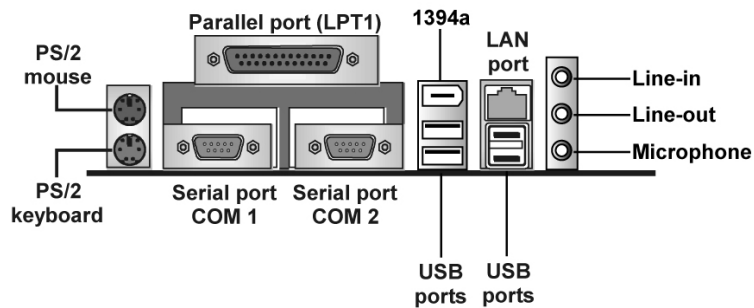

- PS/2 Mouse** Use the upper PS/2 port to connect a PS/2 pointing device.
- PS/2 Keyboard** Use the lower PS/2 port to connect a PS/2 keyboard.
- LPT1** Use LPT1 to connect printers or other parallel communications devices.
- COM1/2** Use the COM ports to connect serial devices such as mice or fax/modems. COM1 is identified by the system as COM1/3. COM2 is identified by the system as COM2/4.
- 1394a Port (optional)** Use the 1394a port to connect any Firewire device.
- Audio Ports** Use the three audio ports to connect audio devices. The first jack is for stereo line-in signal. The second jack is for stereo line-out signal. The third jack is for microphone.
- LAN Port (optional)** Connect an RJ-45 jack to the LAN port to connect your computer to the Network.
- USB Ports** Use the USB ports to connect USB devices.

External Connector Color Coding

Many connectors now use standard colors as shown in the table below.

Connector	Color
Audio line-in	Light blue
Audio line-out	Lime
Digital monitor/flat panel	White
IEEE 1394	Grey
Microphone	Pink
MIDI/game	Gold
Parallel	Burgundy
PS/2-compatible keyboard	Purple
PS/2-compatible mouse	Green
Serial	Teal or Turquoise
Speaker out/subwoofer	Orange
Right-to-left speaker	Brown
USB	Black
Video out	Yellow
SCSI, network, telephone, modem	None

This concludes Chapter 2. The next chapter covers the BIOS.

Chapter 3

Using BIOS

About the Setup Utility

The computer uses the latest Award BIOS with support for Windows Plug and Play. The CMOS chip on the mainboard contains the ROM setup instructions for configuring the mainboard BIOS.

The BIOS (Basic Input and Output System) Setup Utility displays the system's configuration status and provides you with options to set system parameters. The parameters are stored in battery-backed-up CMOS RAM that saves this information when the power is turned off. When the system is turned back on, the system is configured with the values you stored in CMOS.

The BIOS Setup Utility enables you to configure:

- Hard drives, diskette drives, and peripherals
- Video display type and display options
- Password protection from unauthorized use
- Power management features

The settings made in the Setup Utility affect how the computer performs. Before using the Setup Utility, ensure that you understand the Setup Utility options.

This chapter provides explanations for Setup Utility options.

The Standard Configuration

A standard configuration has already been set in the Setup Utility. However, we recommend that you read this chapter in case you need to make any changes in the future.

This Setup Utility should be used:

- when changing the system configuration
- when a configuration error is detected and you are prompted to make changes to the Setup Utility
- when trying to resolve IRQ conflicts
- when making changes to the Power Management configuration
- when changing the password or making other changes to the Security Setup

BIOS Navigation Keys

The BIOS navigation keys are listed below:

Key	Function
Esc	Exits the current menu
←↑↓→	Scrolls through the items on a menu
+/-/PU/PD	Modifies the selected field's values
F10	Saves the current configuration and exits setup
F1	Displays a screen that describes all key functions
F5	Loads previously saved values to CMOS
F6	Loads a minimum configuration for troubleshooting.
F7	Loads an optimum set of values for peak performance

Updating the BIOS

You can download and install updated BIOS for this mainboard from the manufacturer's Web site. New BIOS provides support for new peripherals, improvements in performance, or fixes for known bugs. Install new BIOS as follows:

1. If your mainboard has a BIOS protection jumper, change the setting to allow BIOS flashing.
2. If your mainboard has an item called Firmware Write Protect in Advanced BIOS features, disable it. (Firmware Write Protect prevents BIOS from being overwritten.)
3. Create a bootable system disk. (Refer to Windows online help for information on creating a bootable system disk.)
4. Download the Flash Utility and new BIOS file from the manufacturer's Web site. Copy these files to the system diskette you created in Step 3.
5. Turn off your computer and insert the system diskette in your computer's diskette drive. (You might need to run the Setup Utility and change the boot priority items on the Advanced BIOS Features Setup page, to force your computer to boot from the floppy diskette drive first.)
6. At the A:\ prompt, type the Flash Utility program name and press <Enter>. You see a screen similar to the following:

FLASH MEMORY WRITER V7.33	
(C) Award Software 1999 All Rights Reserved	
For (MAINBOARD NAME)	DATE: 10/26/2000
Flash Type	
File Name to Program :	<input type="text"/>
Error Message	

7. Type the filename of the new BIOS in the "File Name to Program" text box. Follow the onscreen directions to update the mainboard BIOS.

8. When the installation is complete, remove the floppy diskette from the diskette drive and restart your computer. If your mainboard has a Flash BIOS jumper, reset the jumper to protect the newly installed BIOS from being overwritten.

Using BIOS

When you start the Setup Utility, the main menu appears. The main menu of the Setup Utility displays a list of the options that are available. A highlight indicates which option is currently selected. Use the cursor arrow keys to move the highlight to other options. When an option is highlighted, execute the option by pressing <Enter>.

Some options lead to pop-up dialog boxes that prompt you to verify that you wish to execute that option. Other options lead to dialog boxes that prompt you for information.

Some options (marked with a triangle ►) lead to submenus that enable you to change the values for the option. Use the cursor arrow keys to scroll through the items in the submenu.

In this manual, default values are enclosed in parenthesis. Submenu items are denoted by a triangle ►.

Standard CMOS Features

In the Standard CMOS menu you can set the system clock and calendar, record disk drive parameters and the video subsystem type, and select the type of errors that stop the BIOS POST.

Phoenix – AwardBIOS CMOS Setup Utility
Standard CMOS Features

Date (mm:dd:yy)	Tue, July 11 2001	Item Help
Time (hh:mm:ss)	12 : 8 : 59	Menu Level ►
► IDE Primary Master		Change the day, month, year and century.
► IDE Primary Slave		
► IDE Secondary Master		
► IDE Secondary Slave		
Drive A	[1.44M, 3.5 in.]	
Drive B	[None]	
Video		
[EGA/VGA]		
Halt On	[But keyboard]	
Base Memory	640K	
Extended Memory	31744K	
Total Memory	32768K	

↑↓ : Move Enter : Select +/-/PU/PD:Value F10: Save ESC: Exit F1:General Help
 F5:Previous Values F6:Fail-Safe Defaults F7:Optimized Defaults

Date and Time

The Date and Time items show the current date and time on the computer. If you are running a Windows OS, these items are automatically updated

whenever you make changes to the Windows Date and Time Properties utility.

► **IDE Devices (None)**

Your computer has two IDE channels (Primary and Secondary) and each channel can be installed with one or two devices (Master and Slave). Use these items to configure each device on the IDE channel.

Press <Enter> to display the IDE submenu:

Phoenix – AwardBIOS CMOS Setup Utility
IDE Primary Master

IDE HDD Auto-Detection	[Press Enter]	Item Help
IDE Primary Master	[Auto]	Menu Level ►►
Access Mode	[Auto]	To auto-detect the HDD's size, head . . . on this channel
Capacity	0 MB	
Cylinder	0	
Head	0	
Precomp	0	
Landing Zone	0	
Sector	0	

↑↓→← : Move Enter : Select +/-/PU/PD:Value: F10: Save ESC: Exit F1:General Help
 F5:Previous Values F6:Fail-Safe Defaults F7:Optimized Defaults

IDE HDD Auto-Detection

Press <Enter> while this item is highlighted to prompt the Setup Utility to automatically detect and configure an IDE device on the IDE channel.

Note: If you are setting up a new hard disk drive that supports LBA mode, more than one line will appear in the parameter box. Choose the line that lists LBA for an LBA drive.

IDE Primary/Secondary Master/Slave

Leave this item at Auto to enable the system to automatically detect and configure IDE devices on the channel. If it fails to find a device, change the value to Manual and then manually configure the drive by entering the characteristics of the drive in the items described below.

Refer to your drive's documentation or look on the drive casing if you need to obtain this information. If no device is installed, change the value to None.

Note: Before attempting to configure a hard disk drive, ensure that you have the configuration information supplied by the manufacturer of your hard drive. Incorrect settings can result in your system not recognizing the installed hard disk.

Access Mode

This item defines ways that can be used to access IDE hard disks such as LBA (Large Block Addressing). Leave this value at Auto and the system will automatically decide the fastest way to access the hard disk drive.

Press <Esc> to return to the Standard CMOS Features screen.

Drive A/Drive B (1.44M, 3.5 in./None)

These items define the characteristics of any diskette drive attached to the system. You can connect one or two diskette drives.

Floppy 3 Mode Support (Disabled)

Floppy 3 mode refers to a 3.5-inch diskette with a capacity of 1.2 MB. Floppy 3 mode is sometimes used in Japan.

Video (EGA/VGA)

This item defines the video mode of the system. This mainboard has a built-in VGA graphics system; you must leave this item at the default value.

Halt On (But keyboard)

This item defines the operation of the system POST (Power On Self Test) routine. You can use this item to select which types of errors in the POST are sufficient to halt the system.

Base Memory, Extended Memory, and Total Memory

These items are automatically detected by the system at start up time. These are display-only fields. You cannot make changes to these fields.

Advanced BIOS Setup

This screen contains industry-standard options additional to the core PC AT BIOS.

Phoenix – AwardBIOS CMOS Setup Utility Advanced BIOS Setup

		Item Help
CPU Internal Cache	[Enabled]	
External Cache	[Enabled]	
CPU L2 Cache ECC Checking	[Enabled]	
Processor Number Feature	[Enabled]	
Quick Power On Self Test	[Enabled]	
First Boot Device	[Floppy]	
Second Boot Device	[HDD-0]	
Third Boot Device	[CD-ROM]	
Boot Other Device	[Enabled]	
Swap Floppy Drive	[Disabled]	
Boot Up Floppy Seek	[Disabled]	
Boot Up NumLock Status	[On]	
Gate A20 Option	[Fast]	
ATA 66/100 IDE Cable Msg	[Disabled]	
Typematic Rate Setting	[Disabled]	
x Typematic Rate (Chars/Sec)	6	
x Typematic Delay (Msec)	250	
Security Option	[Setup]	
		Menu Level ▶
		Allows you to choose the VIRUS warning feature for IDE Hard Disk boot sector protection. If this function is enabled and someone attempts to write data into this area, BIOS will show a warning message on screen and alarm beep

↑↓ →← : Move Enter : Select +/-/PU/PD:Value: F10: Save ESC: Exit F1:General Help
F5:Previous Values F6:Fail-Safe Defaults F7:Optimized Defaults

CPU Internal Cache (Enabled)

All processors that can be installed in this mainboard use internal level 1 (L1) cache memory to improve performance. Leave this item at the default value

for better performance.

External Cache (Enabled)

Most processors that can be installed in this system use external level 2 (L2) cache memory to improve performance. Leave this item at the default value for better performance.

CPU L2 Cache ECC Checking (Enabled)

This item enables or disables ECC (Error Correction Code) error checking on the CPU cache memory. We recommend that you leave this item at the default value.

Processor Number Feature (Enabled)

Some new processors are installed with a unique processor number. This number may be used for verification in Internet transactions and e-commerce. If you prefer not to use or distribute the unique processor number, disable this item to suppress the processor number.

Quick Power On Self Test (Enabled)

Enable this item to shorten the power on testing (POST) and have your system start up faster. You might like to enable this item after you are confident that your system hardware is operating smoothly.

First/Second/Third Boot Device (Floppy/HDD-0/CD-ROM)

Use these three items to select the priority and order of the devices that your system searches for an operating system at start-up time.

Boot Other Device (Enabled)

When enabled, the system searches all other possible locations for an operating system if it fails to find one in the devices specified under the First, Second, and Third boot devices.

Swap Floppy Drive (Disabled)

If you have two floppy diskette drives in your system, this item allows you to swap the assigned drive letters so that drive A becomes drive B, and drive B becomes drive A.

Boot Up Floppy Seek (Disabled)

If this item is enabled, it checks the size of the floppy disk drives at start-up time. You don't need to enable this item unless you have a legacy diskette drive with 360K capacity.

Boot Up NumLock Status (On)

This item defines if the keyboard Num Lock key is active when your system is started.

Gate A20 Option (Fast)

This item defines how the system handles legacy software that was written for an earlier generation of processors. Leave this item at the default value.

ATA 66/100 IDE Cable Msg (Disabled)

Enables or disables the ATA 66/100 IDE Cable Msg. This message will appear during reboot when you use 40-pin cable on your 66/100 hard disks.

Typematic Rate Setting (Disabled)

If this item is enabled, you can use the following two items to set the typematic rate and the typematic delay settings for your keyboard.

- **Typematic Rate (Chars/Sec):** Use this item to define how many characters per second are generated by a held-down key.
- **Typematic Delay (Msec):** Use this item to define how many milliseconds must elapse before a held-down key begins generating repeat characters.

Security Option (Setup)

If you have installed password protection, this item defines if the password is required at system start up, or if it is only required when a user tries to enter the Setup Utility.

APIC Mode (Enabled)

This item allows you to enable or disable the APIC (Advanced Programmable Interrupt Controller) mode. APIC provides symmetric multi-processing (SMP) for systems, allowing support for up to 60 processors.

OS Select For DRAM > 64 MB (Non-OS2)

This item is only required if you have installed more than 64 MB of memory and you are running the OS/2 operating system. Otherwise, leave this item at the default.

HDD S.M.A.R.T Capability (Disabled)

The S.M.A.R.T. (Self-Monitoring, Analysis, and Reporting Technology) system is a diagnostics technology that monitors and predicts device performance. S.M.A.R.T. software resides on both the disk drive and the host computer.

The disk drive software monitors the internal performance of the motors, media, heads, and electronics of the drive. The host software monitors the overall reliability status of the drive. If a device failure is predicted, the host software, through the Client WORKS S.M.A.R.T applet, warns the user of the impending condition and advises appropriate action to protect the data.

Video BIOS Shadow (Enabled)

This function, when enabled allows VGA BIOS to be copied to the system DRAM for enhanced performance.

Small Logo (EPA) Show (Disabled)

Determines whether or not the EPA logo appears during boot up.

Advanced Chipset Setup

The parameters in this screen are for system designers, service personnel, and technically competent users only. Do not reset these values unless you understand the consequences of your changes.

Phoenix – AwardBIOS CMOS Setup Utility Advanced Chipset Setup

		Item Help
▶ DRAM Clock/Drive Control	[Press Enter]	
▶ AGP & P2P Bridge Control	[Press Enter]	
▶ CPU & PCI Bus Control	[Press Enter]	Menu Level ▶
Memory Hole	[Disabled]	
System BIOS Cacheable	[Disabled]	
Video RAM Cacheable	[Disabled]	
BIOS Write Protect	[Disabled]	

↑↓→← : Move Enter : Select +/-/PU/PD:Value: F10: Save ESC: Exit F1:General Help
 F5:Previous Values F6:Fail-Safe Defaults F7:Optimized Defaults

▶ DRAM Clock/Drive Control

Scroll to this item and press <Enter> to view the following screen:

Phoenix – AwardBIOS CMOS Setup Utility DRAM Clock/Drive Control

		Item Help
Current FSB Frequency		
Current DRAM Frequency		
DRAM Clock	[By SPD]	Menu Level ▶
DRAM Timing	[Auto by SPD]	
DRAM CAS Latency	[2.5]	
Bank Interleave	[Disabled]	
Precharge to Active (Trp)	[3T]	
Active to Precharge (Tras)	[6T]	
Active to CMD (Trcd)	[3T]	
DRAM Burst Length	[4]	
DRAM Queue Depth	[4 level]	
DRAM Command Rate	[2T Command]	

↑↓→← : Move Enter : Select +/-/PU/PD:Value: F10: Save ESC: Exit F1:General Help
 F5:Previous Values F6:Fail-Safe Defaults F7:Optimized Defaults

Current FSB Frequency

This item displays the frontside bus (FSB) frequency. This is a display-only item. You cannot make changes to this field.

Current DRAM Frequency

This item displays the memory (DRAM) frequency. This is a display-only item. You cannot make changes to this field.

DRAM Clock (By SPD)

This item enables you to manually set the DRAM Clock. We recommend that you leave this item at the default value.

DRAM Timing (Auto by SPD)

Set this By SPD to enable the system to automatically set the SDRAM timing by SPD (Serial Presence Detect). SPD is an EEPROM chip on the DIMM module that stores information about the memory chips it contains, including size, speed, voltage, row and column addresses, and manufacturer. If you disable this item, you can use the following three items to manually set the timing parameters for the system memory

DRAM CAS Latency (2.5)

Enables you to select the CAS latency time in HCLKs of 2/2 or 3/3. The value is set at the factory depending on the DRAM installed. Do not change the values in this field unless you change specifications of the installed DRAM or the installed CPU. The options are "2" and "2.5" default.

Bank Interleave (Disabled)

Enable this item to increase memory speed. When enabled, separate memory banks are set for odd and even addresses and the next byte of memory can be accessed while the current byte is being refreshed.

Precharge to Active (3T/4T)

This item is used to designate the minimum Row Precharge time of the SDRAM devices on the module.

DRAM must continually be refreshed or it will lose its data. Normally, DRAM is refreshed entirely as the result of a single request. This option allows you to determine the number of CPU clocks allocated for the Row Address Strobe (RAS) to accumulate its charge before the DRAM is refreshed. If insufficient time is allowed, refresh may be incomplete and data lost.

Active to Precharge (6T/10T)

This item specifies the number of clock cycles needed after a bank active command before a precharge can occur.

Active to CMD (3T)

This item specifies the minimum required delay between activation of different rows.

DRAM Burst Len (4)

This item describes which burst lengths are supported by the devices on the mainboard. 1 level can provide faster performance but may result in instability whereas 8 level gives the most stable but slowest performance.

DRAM Queue Depth (4 level)

This item sets the depth of the DRAM queue used for CPU's cache.

DRAM Command Rate (2T command)

This item enables you to specify the waiting time for the CPU to issue the next command after issuing the command to the DDR memory. We recommend

that you leave this item at the default value.

Write Recovery Time (3T)

This item controls the timing between write and precharge command.

Press <Esc> to return to the Advanced Chipset Features screen.

► AGP & P2P Bridge Control

Scroll to this item and press <Enter> to view the following screen:

Phoenix – AwardBIOS CMOS Setup Utility
AGP & P2P Bridge Control

		Item Help
AGP Aperture Size	[125 MB]	
AGP Mode	[4X]	
AGP Driving Control	[Auto]	Menu Level ►
x AGP Driving Value	DA	
AGP Fast Write	[Disabled]	
AGP Master 1 WS Write	[Disabled]	
AGP Master WS Read	[Disabled]	

↑↓→← : Move Enter : Select +/-/PU/PD:Value: F10: Save ESC: Exit F1:General Help
F5:Previous Values F6:Fail-Safe Defaults F7:Optimized Defaults

AGP Aperture Size (128 MB)

This item defines the size of the aperture if you use an AGP graphics adapter. The AGP aperture refers to a section of the PCI memory address range used for graphics memory. We recommend that you leave this item at the default value.

AGP Mode (4X)

This item allows you to enable or disable the caching of display data for the processor video memory. Enabling AGP-4X Mode can greatly improve the display speed. Disable this item if your graphics display card does not support this feature.

AGP Driving Control (Auto)

This item is used to signal driving current on AGP cards to auto or manual. Some AGP cards need stronger than normal driving current in order to operate. We recommend that you set this item to the default.

- **AGP Driving Value:** When AGP Driving Control is set to Manual, use this item to set the AGP current driving value.

AGP Fast Write (Disabled)

This item lets you enable or disable the caching of display data for the video memory of the processor. Enabling this item can greatly improve the display speed. Disable this item if your graphics display card does not support this feature.

AGP Master 1 WS Write (Disabled)

This implements a single delay when writing to the AGP Bus. By default, two-wait states are used by the system, providing greater stability.

AGP Master 1 WS Read (Disabled)

This implements a single delay when reading to the AGP Bus. By default, two-wait states are used by the system, allowing for greater stability.

Press <Esc> to return to the Advanced Chipset Features screen.

► CPU & PCI Bus Control

Scroll to this item and press <Enter> to view the following screen:

Phoenix – AwardBIOS CMOS Setup Utility
CPU & PCI Bridge Control

PCI1 Master 0 WS Write [Enabled] PCI2 Master 0 WS Write [Enabled] PCI1 Post Write [Enabled] PCI2 Post Write [Enabled] PCI Delay Transaction [Disabled]	Item Help Menu Level ►
--	---------------------------

↑↓→← : Move Enter : Select +/-/PU/PD:Value: F10: Save ESC: Exit F1:General Help
 F5:Previous Values F6:Fail-Safe Defaults F7:Optimized Defaults

PCI 1/2 Master 0 WS Write (Enabled)

When enabled, writes to the PCI bus are executed with zero wait states, providing faster data transfer.

PCI 1/2 Post Write (Enabled)

When enabled, writes from the CPU to PCU bus are buffered, to compensate for the speed differences between the CPU and PCI bus. When disabled, the writes are not buffered and the CPU must wait until the write is complete before starting another write cycle.

PCI Delay Transaction (Disabled)

The mainboard's chipset has an embedded 32-bit post write buffer to support delay transactions cycles. Select Enabled to support compliance with PCI specification version 2.1.

Press <Esc> to return to the Advanced Chipset Features screen.

Memory Hole (Disabled)

This item is used to reserve memory space for ISA expansion cards that require it.

System BIOS/Video RAM Cacheable (Disabled)

These items allow the video and system to be cached in memory for faster

On-Chip IDE Channel 0/1 (Enabled)

Use these items to enable or disable the PCI IDE channels that are integrated on the mainboard.

IDE Prefetch Mode (Enabled)

The onboard IDE drive interface supports IDE prefetching, for faster drive access. If you install a primary and secondary add-in IDE interface, set this field to Disabled if the interface does not support prefetching.

IDE Primary/Secondary Master/Slave PIO (Auto)

Each IDE channel supports a master device and a slave device. These four items let you assign which kind of PIO (Programmed Input/Output) is used by IDE devices. Choose Auto to let the system auto detect which PIO mode is best, or select a PIO mode from 0-4.

IDE Primary/Secondary Master/Slave UDMA (Auto)

Each IDE channel supports a master device and a slave device. This mainboard supports UltraDMA technology, which provides faster access to IDE devices.

If you install a device that supports UltraDMA, change the appropriate item on this list to Auto. You may have to install the UltraDMA driver supplied with this mainboard in order to use an UltraDMA device.

Press <Esc> to return to the Integrated Peripherals screen.

► **VIA OnChip PCI Device**

Scroll to this item and press <Enter> to view the following screen:

Phoenix – AwardBIOS CMOS Setup Utility
VIA OnChip PCI Device

VIA-3058 AC97 Audio	[Auto]	Item Help
VIA-3068 MC97 Modem	[Auto]	
VIA-3043 OnChip LAN	[Enabled]	Menu Level ►►
Onboard LAN Boot ROM	[Disabled]	

↑↓→← : Move Enter : Select +/-/PU/PD:Value: F10: Save ESC: Exit F1:General Help
 F5:Previous Values F6:Fail-Safe Defaults F7:Optimized Defaults

VIA-3058 AC97 Audio (Auto)

Enables and disables the onboard audio chip. Disable this item if you are going to install a PCI audio add-in card.

VIA-3068 MC97 Modem (Auto)

Enables and disables the onboard modem. Disable this item if you are going to install an external modem.

VIA-3043 OnChip LAN (Enabled)

Enables and disables the onboard LAN.

Onboard LAN Boot ROM (Disabled)

Use this item to enable and disable the booting from the onboard LAN or a network add-in card with a remote boot ROM installed.

Press <Esc> to return to the Integrated Peripherals screen.

► **SuperIO Device**

Scroll to this item and press <Enter> to view the following screen:

Phoenix – AwardBIOS CMOS Setup Utility
SuperIO Device

Onboard FDC Controller	[Enabled]	Item Help
Onboard Serial Port 1	[3F8/IRQ4]	Menu Level ►►
Onboard Serial Port 2	[2F8/IRQ3]	
UART Mode Select	[Normal]	
UR2 Duplex Mode	[Half]	
Onboard Parallel Port	[378/IRQ7]	
Parallel Port Mode	[ECP]	
ECP Mode Use DMA	[3]	

↑↓→← : Move Enter : Select +/-/PU/PD:Value: F10: Save ESC: Exit F1:General Help
F5:Previous Values F6:Fail-Safe Defaults F7:Optimized Defaults

Onboard FDC Controller (Enabled)

This option enables the onboard floppy disk drive controller.

Onboard Serial Port 1 (3F8/IRQ4)

This option is used to assign the I/O address and interrupt request (IRQ) for the onboard serial port 1 (COM1).

Onboard Serial Port 2 (2F8/IRQ3)

This option is used to assign the I/O address and interrupt request (IRQ) for the onboard serial port 2 (COM2).

UART Mode Select (Normal)

This field is available if the Onboard Serial Port 2 field is set to any option but Disabled. UART Mode Select enables you to select the infrared communication protocol: Normal (default), IrDA, or ASKIR. IrDA is an infrared communication protocol with a maximum baud rate up to 115.2K bps. ASKIR is Sharp's infrared communication protocol with a maximum baud rate up to 57.6K bps.

UR2 Duplex Mode (Half)

This field is available when UART 2 Mode is set to either ASKIR or IrDA. This item enables you to determine the infrared function of the onboard infrared chip. The options are Full and Half (default).

Full-duplex means that you can transmit and send information simultaneously. Half-duplex is the transmission of data in both directions, but only one direction at a time.

Onboard Parallel Port (378/IRQ7)

This option is used to assign the I/O address and interrupt request (IRQ) for the onboard parallel port.

Parallel Port Mode (ECP)

Enables you to set the data transfer protocol for your parallel port. There are four options: SPP (Standard Parallel Port), EPP (Enhanced Parallel Port), ECP (Extended Capabilities Port) and ECP+EPP.

SPP allows data output only. Extended Capabilities Port (ECP) and Enhanced Parallel Port (EPP) are bi-directional modes, allowing both data input and output. ECP and EPP modes are only supported with EPP- and ECP-aware peripherals.

ECP Mode Use DMA (3)

When the onboard parallel port is set to ECP mode, the parallel port can use DMA 3 or DMA 1.

Game Port Address (201)

This item sets the I/O address for the game port.

Midi Port Address (330)

This item sets the I/O address for the Midi function.

Midi Port IRQ (10)

This item sets the interrupt request for the Midi function.

Press <Esc> to return to the Integrated Peripherals screen.

Init Display First (PCI Slot)

Use this item to specify whether your graphics adapter is installed in one of the PCI slots or is integrated on the mainboard.

OnChip USB Controller (All Enabled)

Enable this item if you plan to use the Universal Serial Bus ports on this mainboard.

USB Keyboard Support (Disabled)

Enable this item if you plan to use a keyboard connected through the USB port in a legacy operating system (such as DOS) that does not support Plug and Play.

USB Mouse Support (Disabled)

Enable this item if you plan to use a USB mouse.

Onboard RAID Device (Enabled)

Enable this item if you plan to use the RAID device.

Onboard 1394 Device (Enabled)

Enable this item if you plan to use the 1394 device.

IDE HDD Block Mode (Enabled)

Enable this field if your IDE hard drive supports block mode. Block mode enables BIOS to automatically detect the optimal number of block read and writes per sector that the drive can support and improves the speed of access to IDE devices.

PWRON After PWR-Fail (Off)

This item enables your computer to automatically restart or return to its last operating status after power returns from a power failure.

Power Management Setup

The Power Management Setup Menu option is used to change the values of the chipset registers for system power management.

Power Management Timeouts

The power-saving modes can be controlled by timeouts. If the system is inactive for a time, the timeouts begin counting. If the inactivity continues so that the timeout period elapses, the system enters a power-saving mode. If any item in the list of Reload Global Timer Events is Enabled, then any activity on that item will reset the timeout counters to zero.

Wake Up Calls

If the system is suspended, or has been powered down by software, it can be resumed by a wake up call that is generated by incoming traffic to a modem, a LAN card, a PCI card, or a fixed alarm on the system realtime clock.

Phoenix – AwardBIOS CMOS Setup Utility Power Management Setup

		Item Help
ACPI function	[Enabled]	
ACPI Suspend Type	[S1(POS)]	
Power Management Option	[User Define]	Menu Level ▶
HDD Power Down	[Disable]	
Suspend Mode	[Disable]	
Video Off Option	[Suspend -> Off]	
Video Off Method	[DPMS Support]	
MODEM Use IRQ	[3]	
Soft-Off by PWRBTN	[Instant-Off]	
▶ IRQ/Event Activity Detect	[Press Enter]	

↑↓ → ← : Move Enter : Select +/-/PU/PD:Value: F10: Save ESC: Exit F1:General
Help F5:Previous Values F6:Fail-Safe Defaults F7:Optimized Defaults

ACPI Function (Enabled)

This mainboard supports ACPI (Advanced Configuration and Power management Interface). Use this item to enable or disable the ACPI feature.

Note: ACPI is a power management specification that makes hardware status information available to the operating system. ACPI enables a PC to turn its peripherals on and off for improved power management. It also allows the PC to be turned on and off by external devices, so that mouse or keyboard activity wakes up the computer.

ACPI Suspend Type (S1(POS))

Use this item to define how your system suspends. In the default, S1(POS), the suspend mode is equivalent to a software power down. If you select S3 (STR), the suspend mode is a suspend to RAM - the system shuts down with

the exception of a refresh current to the system memory.

Power Management Option (User Define)

This item acts like a master switch for the power-saving modes and hard disk timeouts. If this item is set to Max Saving, power-saving modes occur after a short timeout. If this item is set to Min Saving, power-saving modes occur after a longer timeout. If the item is set to User Define, you can insert your own timeouts for the power-saving modes.

HDD Power Down (Disable)

The IDE hard drive will spin down if it is not accessed within a specified length of time. Options are from 1 Min to 15 Min and Disable.

Suspend Mode (Disable)

The CPU clock will be stopped and the video signal will be suspended if no Power Management events occur for a specified length of time. Full power function will return when a Power Management event is detected. Options are from 1 Min to 1 Hour and Disable.

Video Off Option (Suspend --> Off)

This option defines if the video is powered down when the system is put into suspend mode.

Video Off Method (DPMS Support)

This item defines how the video is powered down to save power. This item is set to DPMS (Display Power Management Software) by default.

MODEM Use IRQ (3)

If you want an incoming call on a modem to automatically resume the system from a power-saving mode, use this item to specify the interrupt request line (IRQ) that is used by the modem. You might have to connect the fax/modem to the mainboard Wake On Modem connector for this feature to work.

Soft-Off by PWRBTN (Instant-Off)

Under ACPI (Advanced Configuration and Power management Interface) you can create a software power down. In a software power down, the system can be resumed by Wake Up Alarms. This item lets you install a software power down that is controlled by the power button on your system. If the item is set to Instant-Off, then the power button causes a software power down. If the item is set to Delay 4 Sec. then you have to hold the power button down for four seconds to cause a software power down.

► **IRQ/Event Activity Detect**

Scroll to this item and press <Enter> to view the following screen:

Phoenix – AwardBIOS CMOS Setup Utility
IRQ/Event Activity Detect

PS2KB WakeUp from S3/S4/S5	[Disabled]	Item Help
PS2KB Wakeup Select	[Hot key]	
PS2MS Wakeup from S3/S4/S5	[Disabled]	Menu Level ►
USB Resume from S3	[Disabled]	
VGA	[OFF]	
LPT & COM	[LPT/COM]	
HDD & FDD	[ON]	
PCI Master	[OFF]	
PowerOn by PCI Card	[Enabled]	
WOL/WOM Resume	[Disabled]	
RTC Alarm Resume	[Disabled]	
x Date (of Month)	0	
x Resume Time (hh:mm:ss)	0 0 0	
► IRQs Activity Monitoring	[Press Enter]	

↑↓→← : Move Enter : Select +/-/PU/PD:Value: F10: Save ESC: Exit F1:General Help
F5:Previous Values F6:Fail-Safe Defaults F7:Optimized Defaults

This item opens a submenu that enables you to set events that will resume the system from a power saving mode.

PS2KB WakeUp from S3/S4/S5 (Disabled)

Enables you to allow keyboard activity to awaken the system from power saving mode.

PS2KB Wakeup Select (Hot key)

Enables you to choose either to press a keyboard hot key or be prompted for a password to wakeup the system from power saving mode.

PS2MS WakeUp from S3/S4/S5 (Disabled)

Enables you to allow mouse activity to awaken the system from power saving mode.

USB Resume from S3 (Disabled)

When set to Enabled, the system power will resume the system from a power saving mode if there is any USB port activity.

VGA (Off)

When set to On, the system power will resume the system from a power saving mode if there is any VGA activity.

LPT & COM (LPT/COM)

When this item is enabled, the system will restart the power-saving timeout counters when any activity is detected on the serial ports, or the parallel port.

HDD & FDD (ON)

When this item is enabled, the system will restart the power-saving timeout counters when any activity is detected on the hard disk drive or the floppy diskette drive.

PCI Master (OFF)

When set to Off, any PCI device set as the Master will not power on the system.

PowerOn by PCI Card (Enabled)

Use this item to enable PCI activity to wakeup the system from a power saving mode.

WOL/WOM Resume (Disabled)

Use this item to enable LAN or modem activity to wakeup the system from a power saving mode.

RTC Alarm Resume (Disabled)

When set to Enabled, additional fields become available and you can set the date (day of the month), hour, minute and second to turn on your system. When set to 0 (zero) for the day of the month, the alarm will power on your system every day at the specified time.

▶▶ IRQs Activity Monitoring

Scroll to this item and press <Enter> to view the following screen:

Phoenix – AwardBIOS CMOS Setup Utility
IRQs Activity Monitoring

Primary INTR	[ON]	Item Help
IRQ 3 (COM2)	[Enabled]	Menu Level ▶▶▶
IRQ 4 (COM1)	[Enabled]	
IRQ 5 (LPT2)	[Enabled]	
IRQ 6 (Floppy Disk)	[Enabled]	
IRQ 7 (LPT1)	[Enabled]	
IRQ 8 (RTC Alarm)	[Disabled]	
IRQ 9 (IRQ2 Redir)	[Disabled]	
IRQ 10 (Reserved)	[Disabled]	
IRQ 11 (Reserved)	[Disabled]	
IRQ 12 (PS/2 Mouse)	[Enabled]	
IRQ 13 (Coprocessor)	[Enabled]	
IRQ 14 (Hard Disk)	[Enabled]	
IRQ 15 (Reserved)	[Disabled]	

↑↓ → ← : Move Enter : Select +/-/PU/PD:Value: F10: Save ESC: Exit F1:General Help
F5:Previous Values F6:Fail-Safe Defaults F7:Optimized Defaults

This screen enables you to set IRQs that will resume the system from a power saving mode.

Set any IRQ to Enabled to allow activity at the IRQ to wake up the system from a power saving mode.

Press <Esc> to return to the Power Management Setup screen.

PNP/PCI Configurations

This section describes configuring the PCI bus system. PCI (Peripheral Component Interconnect) is a system, which allows I/O devices to operate at speeds nearing CPU's when they communicate with own special components.

All the options describes in this section are important and technical and it is strongly recommended that only experienced users should make any changes to the default settings.

Phoenix - AwardBIOS CMOS Setup Utility PnP/PCI Configurations

		Item Help
PNP OS Installed	[No]	
Reset Configuration Data	[Disabled]	
Resources Controlled by	[Auto(ESCD)]	
x IRQ Resources	Press Enter	Menu Level ▶
PCI/VGA Palette Snoop	[Disabled]	Default is Disabled.
Assign IRQ For VGA	[Enabled]	Select Enabled to reset
Assign IRQ For USB	[Enabled]	Extended System
		Configuration Data (ESCD)
		when you exit Setup if you
		have installed a new add-
		on and the system
		reconfiguration has
		caused such a serious
		conflict that the OS cannot
		boot

↑↓→← : Move Enter : Select +/-/PU/PD:Value: F10: Save ESC: Exit F1:General Help
F5:Previous Values F6:Fail-Safe Defaults F7:Optimized Defaults

PNP OS Installed (No)

Setting this option to Yes allows the PnP OS (instead of BIOS) to assign the system resources such as IRQ and I/O address to the ISA PnP device. The default setting is No.

Reset Configuration Data (Disabled)

If you enable this item and restart the system, any Plug and Play configuration data stored in the BIOS setup is cleared from memory. New updated data is created.

Resources Controlled By (Auto(ESCD))

You should leave this item at the default Auto (ESCD). Under this setting, the system dynamically allocates resources to plug and play devices as they are required.

If you cannot get a legacy ISA (Industry Standard Architecture) expansion card to work properly, you might be able to solve the problem by changing this item to Manual, and then opening up the IRQ Resources and Memory Resources sub-menus.

In the IRQ Resources sub-menu, if you change any of the IRQ assignments to Legacy ISA, then that Interrupt Request Line is reserved for a legacy ISA expansion card. Press <Esc> to close the IRQ Resources sub-menu.

In the Memory Resources sub menu, use the first item Reserved Memory Base to set the start address of the memory you want to reserve for the ISA expansion card. Use the second item Reserved Memory Length to set the amount of reserved memory. Press <Esc> to close the Memory Resources sub-menu.

PCI/VGA Palette Snoop (Disabled)

This item is designed to overcome some problems that can be caused by some non-standard VGA cards. This board includes a built-in VGA system that does not require palette snooping so you must leave this item disabled.

Assign IRQ for VGA/USB (Enabled)

Names the interrupt request (IRQ) line assigned to the USB/VGA (if any) on your system. Activity of the selected IRQ always awakens the system.

PC Health Status

On mainboards that support hardware monitoring, this item lets you monitor the parameters for critical voltages, critical temperatures, and fan speeds.

Phoenix – AwardBIOS CMOS Setup Utility
PC Health Status

<p>Shutdown Temperature [Disabled]</p> <p>CPU V-CORE + 2.5V + 3.3V + 5V + 12V Voltage Battery Current System Temp Current CPU Temp CPUFAN1 CASFAN1</p>	<p>Item Help</p> <hr/> <p>Menu Level ▶</p>
---	---

↑↓→← : Move Enter : Select +/-/PU/PD:Value: F10: Save ESC: Exit F1:General Help
F5:Previous Values F6:Fail-Safe Defaults F7:Optimized Defaults

Shutdown Temperature (Disabled)

Enables you to set the maximum temperature the system can reach before powering down.

System Component Characteristics

These fields provide you with information about the systems current operating status. You cannot make changes to these fields.

Frequency/Voltage Control

This item enables you to set the clock speed and system bus for your system. The clock speed and system bus are determined by the kind of processor you have installed in your system.

Phoenix – AwardBIOS CMOS Setup Utility Frequency/Voltage Control

Auto Detect DIMM/PCI Clk	[Enabled]	Item Help
Spread Spectrum	[Enabled]	
CPU Clock	[100]	Menu Level ▶
CPU Voltage Adjust	[Normal]	
DIMM Voltage Adjust	[Normal]	

↑↓→← : Move Enter : Select +/-/PU/PD:Value: F10: Save ESC: Exit F1:General Help
F5:Previous Values F6:Fail-Safe Defaults F7:Optimized Defaults

Auto Detect DIMM/PCI Clk (Enabled)

When this item is enabled, BIOS will disable the clock signal of free DIMM and PCI slots.

Spread Spectrum (Enabled)

If you enable spread spectrum, it can significantly reduce the EMI (Electro-Magnetic Interference) generated by the system.

CPU Clock (100)

This item allows you to adjust the CPU clock to 100Mhz or 200MHz. You can key-in the numbers within the range to make a precise and ideal adjustment.

CPU Voltage Adjust (Normal)

This item allows you to control the voltage delivered to the CPU core. It is not recommended that you change the default setting. But expert overclockers can very well fine-tune the voltage to aid in speed and stability of an overclocked processor.

DIMM Voltage Adjust (Normal)

This item adjusts the voltage delivered to the DIMM memory.

Load Fail-Safe Defaults

This option opens a dialog box that lets you install fail-safe defaults for all appropriate items in the Setup Utility:

Press <Y> and then <Enter> to install the defaults. Press <N> and then <Enter> to not install the defaults. The fail-safe defaults place no great demands on the system and are generally stable. If your system is not functioning correctly, try installing the fail-safe defaults as a first step in getting your system working properly again. If you only want to install fail-safe defaults for a specific option, select and display that option, and then press <F6>.

Load Optimized Defaults

This option opens a dialog box that lets you install optimized defaults for all appropriate items in the Setup Utility. Press <Y> and then <Enter> to install the defaults. Press <N> and then <Enter> to not install the defaults. The optimized defaults place demands on the system that may be greater than the performance level of the components, such as the CPU and the memory. You can cause fatal errors or instability if you install the optimized defaults when your hardware does not support them. If you only want to install setup defaults for a specific option, select and display that option, and then press <F7>.

Set Supervisor/User Password

When this function is selected, the following message appears at the center of the screen to assist you in creating a password.

ENTER PASSWORD

Type the password, up to eight characters, and press <Enter>. The password typed now will clear any previously entered password from CMOS memory. You will be asked to confirm the password. Type the password again and press <Enter>. You may also press <Esc> to abort the selection.

To disable password, just press <Enter> when you are prompted to enter password. A message will confirm the password being disabled. Once the password is disabled, the system will boot and you can enter BIOS Setup freely.

PASSWORD DISABLED

If you have selected "**System**" in "Security Option" of "BIOS Features Setup" menu, you will be prompted for the password every time the system reboots or any time you try to enter BIOS Setup.

If you have selected "**Setup**" at "Security Option" from "BIOS Features Setup" menu, you will be prompted for the password only when you enter BIOS Setup.

Supervisor Password has higher priority than User Password. You can use Supervisor Password when booting the system or entering BIOS Setup to modify all settings. Also you can use User Password when booting the system or entering BIOS Setup but can not modify any setting if Supervisor Password

is enabled.

Save & Exit Setup

Highlight this item and press <Enter> to save the changes that you have made in the Setup Utility and exit the Setup Utility. When the Save and Exit dialog box appears, press <Y> to save and exit, or press <N> to return to the main menu:

Exit Without Saving

Highlight this item and press <Enter> to discard any changes that you have made in the Setup Utility and exit the Setup Utility. When the Exit Without Saving dialog box appears, press <Y> to discard changes and exit, or press <N> to return to the main menu.

Note: If you have made settings that you do not want to save, use the "Exit Without Saving" item and press <Y> to discard any changes you have made.

This concludes Chapter 3. Refer to the next chapter for information on the software supplied with the mainboard.

Chapter 4

Using the Mainboard Software

About the Software CD-ROM

The support software CD-ROM that is included in the mainboard package contains all the drivers and utility programs needed to properly run the bundled products. Below you can find a brief description of each software program, and the location for your mainboard version. More information on some programs is available in a README file, located in the same directory as the software.

Note: Never try to install software from a folder that is not specified for use with your mainboard.

Before installing any software, always inspect the folder for files named README.TXT, INSTALL.TXT, or something similar. These files may contain important information that is not included in this manual.

Auto-installing under Windows 98/ME/2000/XP

The Auto-install CD-ROM makes it easy for you to install the drivers and software for your mainboard.

Note: If the Auto-install CD-ROM does not work on your system, you can still install drivers through the file manager for your OS (for example, Windows Explorer). Refer to Utility Folder Installation Notes later in this chapter.

The support software CD-ROM disc loads automatically under Windows 98/ME/2000/XP. When you insert the CD-ROM disc in the CD-ROM drive, the autorun feature will automatically bring up the install screen. The screen has three buttons on it, Setup, Browse CD and Exit.



Note: If the opening screen doesn't appear, double-click the file "setup.exe" in the root directory.

Setup Tab

Setup	Click the Setup button to run the software installation program. Select from the menu which software you want to install.
Browse CD	<p>The Browse CD button is the standard Windows command that allows you to open Windows Explorer and show the contents of the support CD.</p> <p>Before installing the software from Windows Explorer, look for a file named README.TXT, INSTALL.TXT or something similar. This file may contain important information to help you install the software correctly.</p> <p>Some software is installed in separate folders for different operating systems, such as DOS, WIN NT, or WIN98/95. Always go to the correct folder for the kind of OS you are using.</p> <p>To install the software, execute a file named SETUP.EXE or INSTALL.EXE by double-clicking the file and then following the instructions on the screen.</p>
Exit	The Exit button closes the Auto Setup window.

Application Tab

Lists the software utilities that are available on the CD.

Read Me Tab

Displays the path for all software and drivers available on the CD.

Running Setup

Follow these instructions to install device drivers and software for the mainboard:

1. Click **Setup**. The installation program begins:

Mainboard model

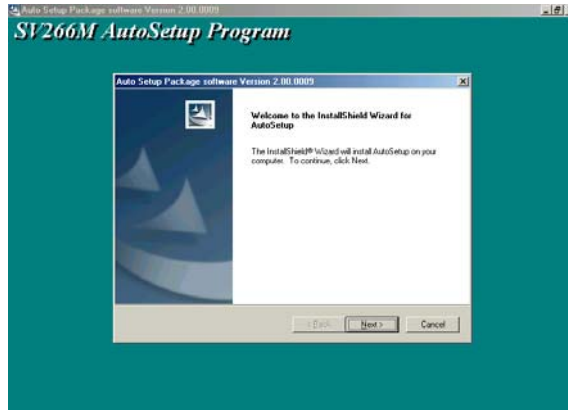

Note: The following screens are examples only. The screens and driver lists will be different according to the mainboard you are installing.

The mainboard identification is located in the upper left-hand corner.

2. Click **Next**. The following screen appears:

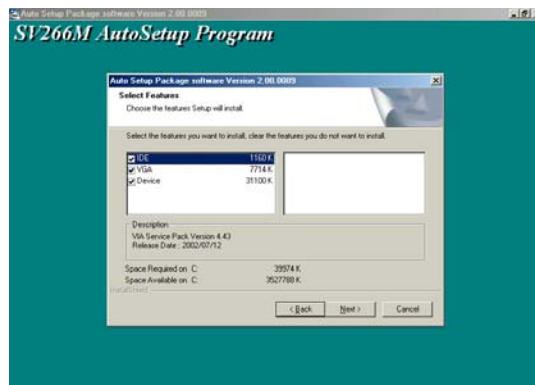

3. Check the box next to the items you want to install. The default options are recommended.
4. Click **Next** run the Installation Wizard. An item installation screen appears:



5. Follow the instructions on the screen to install the items.

Drivers and software are automatically installed in sequence. Follow the onscreen instructions, confirm commands and allow the computer to restart a few times to complete the installation.

Manual Installation

Insert the CD in the CD-ROM drive and locate the PATH.DOC file in the root directory. This file contains the information needed to locate the drivers for your mainboard.

Look for the chipset and mainboard model; then browse to the directory and path to begin installing the drivers. Most drivers have a setup program (SETUP.EXE) that automatically detects your operating system before installation. Other drivers have the setup program located in the operating system subfolder.

If the driver you want to install does not have a setup program, browse to the operating system subfolder and locate the readme text file (README.TXT or README.DOC) for information on installing the driver or software for your operating system.

Utility Software Reference

All the utility software available from this page is Windows compliant. They are provided only for the convenience of the customer. The following software is furnished under license and may only be used or copied in accordance with the terms of the license.

Note: These software(s) are subject to change at anytime without prior notice.
Please refer to the support CD for available software.

AWARD Flash Memory Utility

This utility lets you erase the system BIOS stored on a Flash Memory chip on the mainboard, and lets you copy an updated version of the BIOS to the chip. Proceed with caution when using this program. If you erase the current BIOS and fail to write a new BIOS, or write a new BIOS that is incorrect, your system will malfunction. Refer to Chapter 3, *Using BIOS* for more information.

WinFlash Utility

The Award WinFlash utility is a Windows version of the DOS Award BIOS flash writer utility. The utility enables you to flash the system BIOS stored on a Flash Memory chip on the mainboard while in a Windows environment. This utility is currently available for WINXP\ME\2000\98SE. To install the WinFlash utility, run WINFLASH.EXE from the following directory:

UTILITY\WINFLASH 1.51

PC-CILLIN 2002

The PC-CILLIN 2002 software program provides anti-virus protection for your system. This program is available for Windows 2000/ME/98SE/XP and Windows NT. Be sure to check the readme.txt and install the appropriate anti-virus software for your operating system.

We strongly recommend users to install this free anti-virus software to help protect your system against viruses.

MediaRing Talk – Telephony Software

To install the MediaRing Talk voice modem software for the built-in modem, go to the directory \UTILITY\MEDIARING TALK, then run MRTALK-SETUP72.EXE to install the application software.

Super Voice – Fax/Modem Software

To install the Super Voice voice, fax, data communication application for use with the built-in fax/modem, go the directory \UTILITY\SUPER_VOICE, then run PICSHELL.EXE to install the application software.

PageABC

The PageABC application software enables you to create your very own home page. To install the PageABC, go to the directory \UTILITYPageABC, and then run SETUP.EXE to install the application software.

This concludes Chapter 4.