

---

---

## ***Copyright and Warranty Notice***

The information in this document is subject to change without notice and does not represent a commitment on part of the vendor, who assumes no liability or responsibility for any errors that may appear in this manual.

No warranty or representation, either expressed or implied, is made with respect to the quality, accuracy or fitness for any particular part of this document. In no event shall the manufacturer be liable for direct, indirect, special, incidental or consequential damages arising from any defect or error in this manual or product.

Product names appearing in this manual are for identification purpose only and trademarks and product names or brand names appearing in this document are property of their respective owners.

This document contains materials protected under International Copyright Laws. All rights reserved. No part of this manual may be reproduced, transmitted or transcribed without the expressed written permission of the manufacturer and authors of this manual.

## ***Revisions***

ABIT reserves the right to revise this publication and to make changes in the content hereof without the obligation to notify any person of such revision or changes.

**SI-2P User's Manual**  
**Part Number: 4200-0268-02, Rev. 1.00**

---

---

## ***Contact Information***

***In North America and South America please contact:***

**ABIT Computer (USA) Corporation**

46808 Lakeview Blvd.

Fremont, California 94538, U.S.A.

[sales@abit-usa.com](mailto:sales@abit-usa.com)

[technical@abit-usa.com](mailto:technical@abit-usa.com)

Tel: 1-510-623-0500

Fax: 1-510-623-1092

***In the UK and Ireland:***

**ABIT Computer Corporation Ltd.**

Unit 3, 24-26 Boulton Road

Stevenage, Herts SG1 4QX, UK

[abituksales@compuserve.com](mailto:abituksales@compuserve.com)

[abituktech@compuserve.com](mailto:abituktech@compuserve.com)

Tel: 44-1438-228888

Fax: 44-1438-226333

***In Germany and Benelux (Belgium, Netherlands, Luxembourg) countries:***

**AMOR Computer B.V. (ABIT's European Office)**

Van Coehoornstraat 7,

5916 PH Venlo, The Netherlands

[sales@abit.nl](mailto:sales@abit.nl)

[technical@abit.nl](mailto:technical@abit.nl)

Tel: 31-77-3204428

Fax: 31-77-3204420

***All other territories not covered above please contact:***

**Taiwan Head Office**

When contacting our headquarters please Note we are located in Taiwan and we are 8+ GMT time. In addition, we have holidays that may be different from those in your country.

**ABIT Computer Corporation**

No.323, YangGuang St., Neihu, Taipei, 114, Taiwan

[sales@abit.com.tw](mailto:sales@abit.com.tw)

[market@abit.com.tw](mailto:market@abit.com.tw)

[technical@abit.com.tw](mailto:technical@abit.com.tw)

Tel: 886-2-8751-8888

Fax: 886-2-8751-3381

---

---

---

---

# Contents

<b>Chapter 1. Introduction .....</b>	<b>1-1</b>
1.1. Features & Specifications .....	1-1
1.2. Item Checklist.....	1-3
1.3. Layout Diagram .....	1-4
<b>Chapter 2. Hardware Setup.....</b>	<b>2-1</b>
2.1. Install The Motherboard .....	2-1
2.2. Install Xeon CPU and Heatsink .....	2-2
2.2.1. Why the system shows incorrect CPU speed in Win2K.....	2-3
2.2.2. How to improve system performance for RedHat 7.2 and RedHat 7.3.....	2-4
2.3. Install System Memory .....	2-5
2.3.1. How to access system memory in excess of 4GB for Microsoft Windows 2000 Advanced Server and Datacenter Server .....	2-6
2.4. Connectors, Headers, and Switches .....	2-7
2.4.1. J37A1, J37B1: ATX Power Input Connectors.....	2-7
2.4.2. J30, J31, J32, J34, J35, J36: FAN Connectors.....	2-8
2.4.3. CCMOS1: CMOS Memory Clearing Header .....	2-9
2.4.4. J39A1, J40A1, J41A1: Thermal Sensor Header .....	2-10
2.4.5. PN1 Header .....	2-11
2.4.6. FDC1 and IDE1 Connectors.....	2-12
2.4.7. J25: Smart Card Reader Connector .....	2-13
2.4.8. PCI Slots: .....	2-14
2.4.9. J33: Hot Plug Switch Header.....	2-15
2.4.10. JP9: Chassis Intrusion Header .....	2-17
2.4.11. JU1: Onboard VGA Output Switch.....	2-17
2.4.12. SO-DIMM Connector.....	2-18
2.4.13. J16/J19: Ultra 160 SCSI Channels Connector .....	2-18
2.4.14. Back Panel Connectors.....	2-19
2.5. SCSI Connection.....	2-20
2.5.1. Why the system hung when it detects AIC7xxx driver under RedHat 7.2.....	2-21

---

---

**Chapter 3. BIOS Setup..... 3-1**

3.1. Main Menu.....3-2  
3.1.1. IDE Primary Master / IDE Primary Slave .....3-3  
3.2. Advanced Menu.....3-6  
3.2.1. Advanced BIOS Features .....3-6  
3.2.2. Advanced Chipset Features .....3-9  
3.2.3. Integrated Peripherals.....3-11  
3.2.4. Power Management Setup.....3-14  
3.2.5. PnP/PCI Configurations .....3-15  
3.3. Security Menu.....3-16  
3.4. PC Health Menu.....3-17  
3.5. Clk/Voltage Menu.....3-18  
3.6. Exit Menu .....3-19

**Chapter 4. SCSI Utility ..... 4-1**

**Chapter 5. Driver Installation ..... 5-1**

5.1. Setup Items .....5-2

## **Chapter 1. Introduction**

---

### **1.1. Features & Specifications**

#### **CPU**

- Supports dual Intel Pentium 4 Xeon up to 2 GHz ~ 2.4 GHz processor

#### **Chipset**

- Intel E7500 (Plumas) chipset supports 400 MHz Front Side Bus
- Supports PCI 2.2, Ultra DMA100 IDE protocol (ICH3)
- Supports PCI-X 66/100/133 MHz (P64H2)

#### **Memory**

- Six 184-pin DIMM slots support Registered ECC DDR RAM module only
- Supports up to 12GB (DDR 200)

#### **Graphics**

- On board 4MB ATI Rage XL PCI VGA accelerator

#### **SCSI**

- Adaptec AIC 7899, dual channel Ultra 160 controller on board
- Support Adaptec SCSI RAID card - 2005S (Raptor)

#### **System BIOS**

- Award Plug and Play BIOS supports APM, DMI, and ACPI
- Write-Protect Anti-Virus function by AWARD BIOS
- 4M-bit Flash ROM

#### **I/O Slot**

- One 32bit/33MHz PCI slot
- One PCI-X 133MHz 64bit slot (support Hot Plug)
- One PCI-X 100MHz 64bit slot (support Hot Plug)
- Two PCI-X 100MHz 64bit slots
- Support Intel VxB InfiniBand

#### **Multi I/O Functions**

- One floppy port
- One channel of bus master IDE Ports supporting up to two Ultra DMA100 devices

- One parallel port and 2 serial port
- PS/2 keyboard and PS/2 mouse connectors
- Support 2 USB ports
- Smart Card Reader connector

**H/W Monitor IC**

- Winbond W83627SF
- Support 5 fan speed monitoring
- Support 9 voltage monitoring
- Response ASF command (Get Even Data, Even Status)

**LAN**

- Onboard Intel 82544GC Gigabit Ethernet Controller
- 10/100/1000 Mb Ethernet
- 100MHz, 64bit PCI-X bus

**Miscellaneous**

- 24 pins and 8 pins EPS12V power connector
- Extend ATX form factor (12" x 13")

**\* Specifications and information contained herein are subject to change without notice.**

## **1.2. Item Checklist**

- (1) SI-2P Motherboard
- (1) User's Manual
- (1) Driver & Utilities CD
- (1) Ribbon cable for (1) 3.5" floppy disk drive
- (1) Ribbon cable for master and slave IDE drives
- (1) 68-pin LVD/SE SCSI cable with terminator for (5) Ultra 160 SCSI devices

### 1.3. Layout Diagram

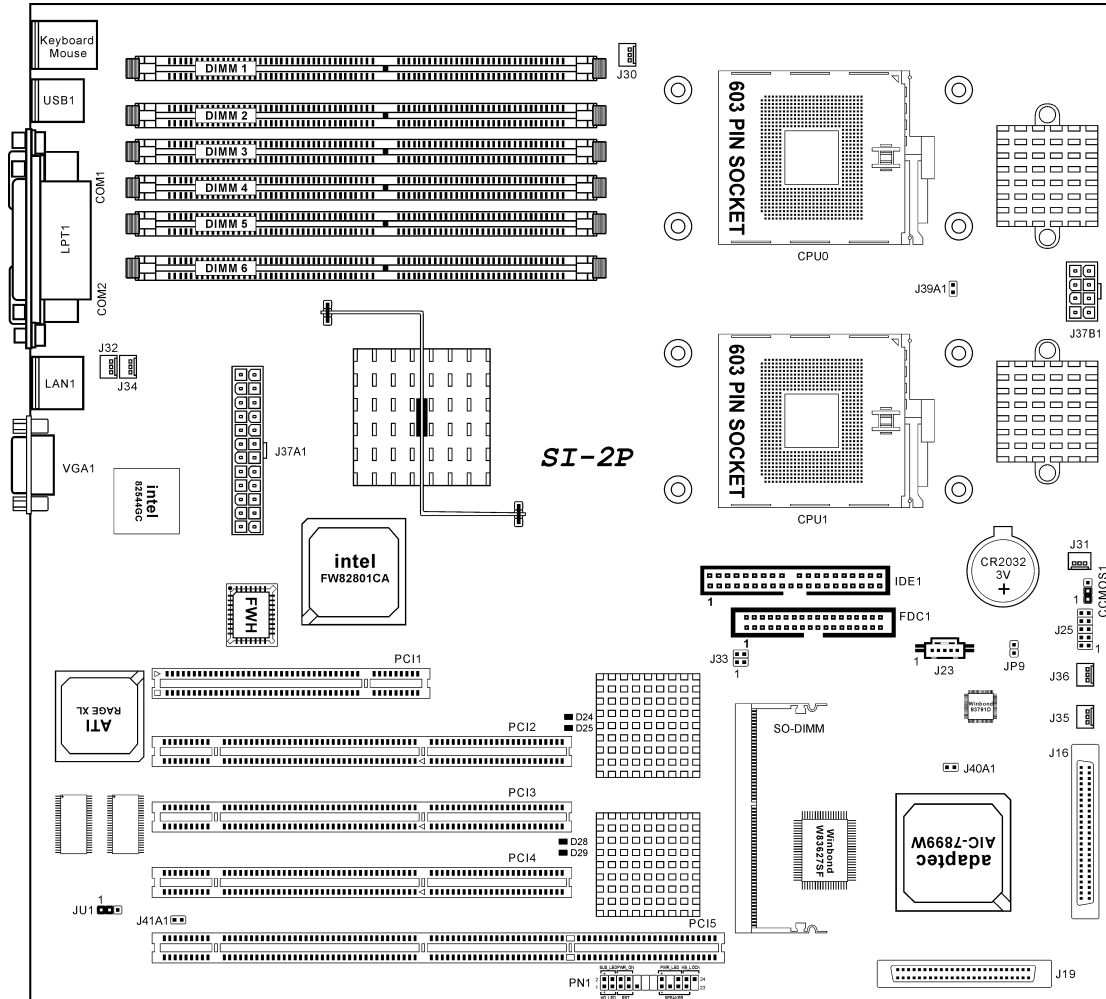



<b>Jumpers</b>	<b>Description</b>	<b>Default Setting</b>
CCMOS1	CMOS Clear	Pins 1-2 (Normal)
JP9	Chassis Opening Sensor Header	Open
JU1	Onboard VGA Output Switch	Pins 1-2 (Enable)
J33	A/B Hot Plug Switch	Open

<b>Connectors</b>	<b>Description</b>
DIMM 1~6	DDR DIMM Slots
FDC1	Floppy Disk Drive Connector:
IDE1	Hard Disk Drive Connector:
J16	Ultra 160 SCSI Channel B Connector
J19	Ultra 160 SCSI Channel A Connector
J23	5-Pin EPS12V Power Connector (Optional)
J25	Smart Card Reader Extension Cable Connector
J30	CPU0 Fan
J31	CPU1 Fan
J34	Fan (No speed monitoring support)
J32	System3 Fan
J35	System2 Fan
J36	System1 Fan
J37A1	24-Pin EPS12V Power Connector
J37B1	8-Pin EPS12V Power Connector
J39A1	System3 Temperature Sensor Connector
J40A1	System2 Temperature Sensor Connector
J41A1	System1 Temperature Sensor Connector
PCI1	PCI 33 MHz/32 bit
PCI2	PCI-X 100 MHz/64 bit
PCI3	PCI-X 133 MHz/64 bit
PCI4/PCI5	PCI-X 100 MHz/64 bit
PN1	Front Panel Switch Header
SO-DIMM	Adaptec Zero Channel RAID Card Connector



## Chapter 2. Hardware Setup

### *Before the Installation*

Turn off the EPS12V power supply switch (fully turn off the +5V standby power), or disconnect the power cord before installing or unplugging any connectors or add-on cards. Failing to do so may cause the motherboard components or add-on cards to malfunction or damaged.

### 2.1. Install The Motherboard

Most computer chassis have a base with many mounting holes to allow motherboard to be securely attached on and at the same time, prevented from short circuits.

There are two ways to attach the motherboard to the chassis base:

1. use with studs
2. or use with spacers

In principle, the best way to attach the board is to use with studs. Only if you are unable to do this should you attach the board with spacers. Line up the holes on the board with the mounting holes on the chassis. If the holes line up and there are screw holes, you can attach the board with studs. If the holes line up and there

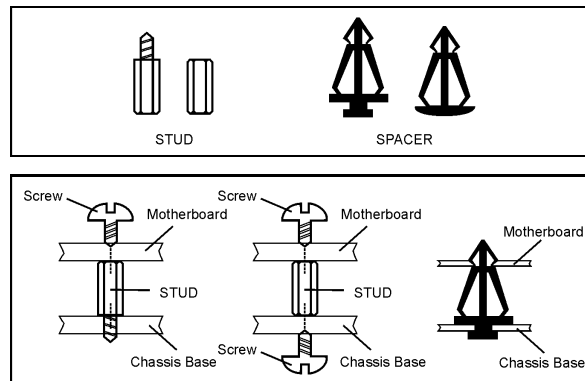

are only slots, you can only attach with spacers. Take the tip of the spacers and insert them into the slots. After doing this to all the slots, you can slide the board into position aligned with slots. After the board has been positioned, check to make sure everything is OK before putting the chassis back on.

**ATTENTION:** To prevent shorting the PCB circuit, please REMOVE the metal studs or spacers if they are already fastened on the chassis base and are without mounting-holes on the motherboard to align with.

## 2.2. Install Xeon CPU and Heatsink

This motherboard provides a Socket 603 to install Intel Xeon CPU. The CPU you bought should have a kit of heatsink and cooling fan bundled together. If that's not the case, buy one specially designed for Xeon Socket 603 CPU. Please refer to the figure shown below to install CPU and heatsink. (For reference only. Your retention mechanism may not be exactly the same as this one.)

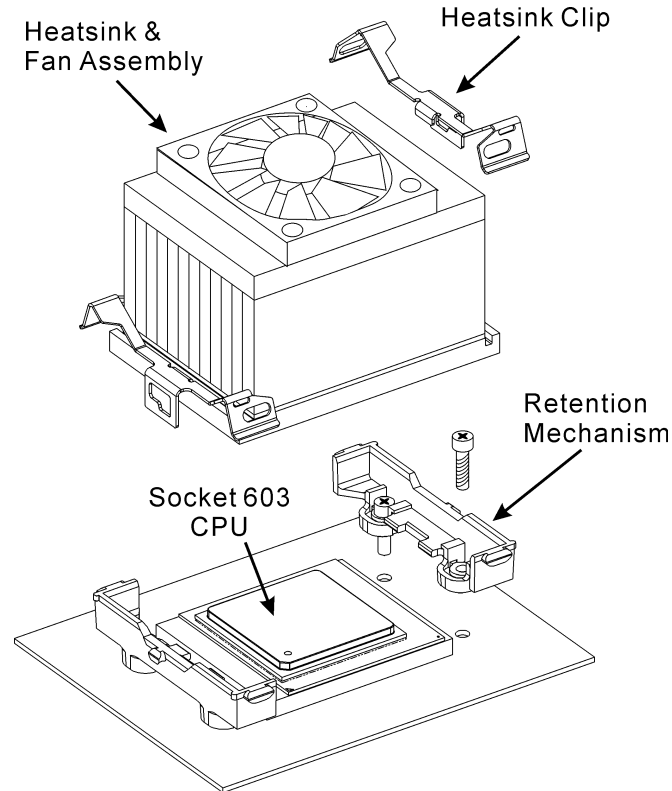

### **2.2.1. Why the system shows incorrect CPU speed in Win2K**

If you run Msinfo32.exe on a computer that has an Intel Pentium 4 Xeon 2.2-GHz or faster processor, a very high processor speed may be shown. The Processor information on the System Summary page shows the correct name, family, model and stepping for the processor, but the approximate speed may be 37,000 MHz or faster.

This is because the speed of the newest Pentium processors exposes a limitation in the speed calculation code in Msinfo32.exe.

To resolve this problem, refer to the hotfix described in the Microsoft Knowledge Base article: “[Q302857](#) WMI Win32\_Group ASSOCIATORS Queries Are Not Optimized”.

### 2.2.2. How to improve system performance for RedHat 7.2 and RedHat 7.3

It is recommended to upgrade RedHat 7.2 to version 7.3, since there are many improvements as well as kernel upgrade. Currently there is limitation about multi-processor handling irq in RedHat 7.3. It is suggested to download the latest kernel in order to improve the performance. The latest kernel 2.4.18 need patch to fix multi-processor handle irq limitation. Please use the following steps to build the kernel.

Download the latest kernel from <http://www.kernel.org>, for example:

```
linux-2.4.18.tar.gz .
# mv linux-2.4.18.tar.gz /usr/src
# gunzip linux-2.4.18.tar.gz (unpack the kernel)
# tar xvf linux-2.4.18.tar (extract form kernel tar file)
# patch -p0 < irq.patch (update necessary patch)
# cd linux
# make mrproper
# make xconfig
# make dep
# make clean
# make bzImage
# cp /usr/src/linux/arch/i386/boot/bzImage
/boot/vmlinuz-24188irqbal
# make modules
# make modules_install
# mkdinitrd /boot/initrd.2.4.18.img 2.4.18
# cp /usr/src/linux/System.map
/boot/System.map-2.4.18-irqbal
# cd /boot
# ln -s System.map-2.4.18-irqbal System.map
# add following entries to /etc/lilo.conf

    image=/boot/vmlinuz-24188irqbal
        label=lin24188irqbal
        initrd=/boot/initrd-2.4.18.img
        read-only
        root=/dev/hda2
# lilo
# reboot
```

## 2.3. Install System Memory

This motherboard provides six 184-pin DDR DIMM slots for Registered ECC RAM modules with memory expansion size up to 12GB (DDR 200). You must insert **TWO** same **Registered ECC** RAM modules at least at DIMM1 and DIMM2 slots to make the system go on booting.

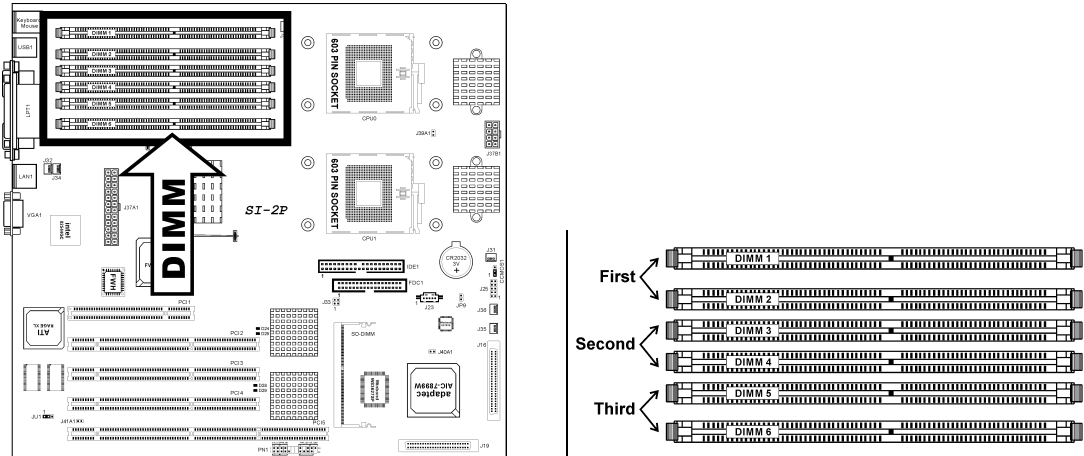

**ATTENTION:** Populate the DDR DIMMs **in-order** and **in-pair** (of the same type and size) by starting from DIMM1-2, DIMM3-4, to DIMM5-6. The System may hang or appear unstable if the DIMM ordering is not followed.

### *How to install and remove memory modules:*

Power off the computer and unplug the AC power cord before installing and removing the memory modules.

Hold two edges of the module carefully and keep away of touching its connectors. Align the two notch keys on the module with the two ribs on the slot. Firmly press the module into the slots until the ejector tabs at both sides of the slot automatically snaps into the mounting notch. As the module can only fit in one orientation, do not push the module in with extra force.

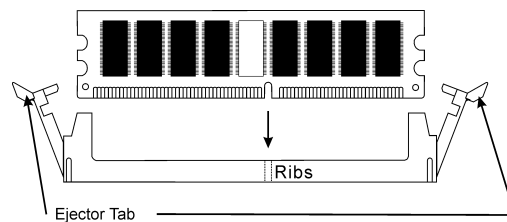

To remove the modules, push the two ejector tabs on the slot outward together, and pull out the module.

**ATTENTION:** As the static electricity can damage the electronic components of the computer or optional boards, make sure you are discharged of static electricity by touching a grounded metal object briefly before starting these procedures.

### 2.3.1. How to access system memory in excess of 4GB for Microsoft Windows 2000 Advanced Server and Datacenter Server

Microsoft Windows 2000 Advanced Server and Datacenter Server support memory in excess of 4GB of RAM by way of the Intel Physical Addressing Extension (PAE) specification. Windows 2000 Advanced Server is limited to 8GB, and Windows 2000 Datacenter Server is limited to 64GB.

You can enable PAE in the “Boot.ini” file. To enable PAE, follow these steps:

1. Locate the Boot.ini file, typically in the root folder (for example, C:) and remove its read-only attribute.
2. Open the Boot.ini file, and then add the **/PAE** parameter to the ARC path, as shown in bold format in the following example:

```
multi(0)disk(0)rdisk(0)partition(2)\WINNT= “Windows 2000 Advanced  
Server” /PAE /basevideo /sos
```

3. On the **File** menu, click **Save**.
4. Restore the read-only attribute to the Boot.ini file.

Even with PAE enabled, the underlying architecture of the system is still based on 32-bit linear addresses. This effectively retains the 2GB of application space and the 2GB of kernel mode space because only 4GB of addresses are available. However, multiple processes can immediately benefit from the increased RAM because they are less likely to encounter physical memory restrictions and begin paging. Additionally, applications can be modified to use the AWE API to allocate memory outside of the applications process space, bypassing the 2-GB limit for applications.



## 2.4. Connectors, Headers, and Switches

All the connectors, headers and switches mentioned here are depending on your system configuration. Some features you may (or may not) have to connect or to configure depending on the peripherals you have connected.

**WARNING:** Always power off the computer and unplug the AC power cord before adding or removing any peripheral or component. Failing to do so may cause severe damage to your motherboard and/or peripherals. Plug in the AC power cord only after you have carefully checked everything.

### 2.4.1. J37A1, J37B1: ATX Power Input Connectors

These two connectors connect to EPS12V power supply. This motherboard requires an ATX power supplier with 460W capacity at least for Pentium 4 Xeon CPU system.

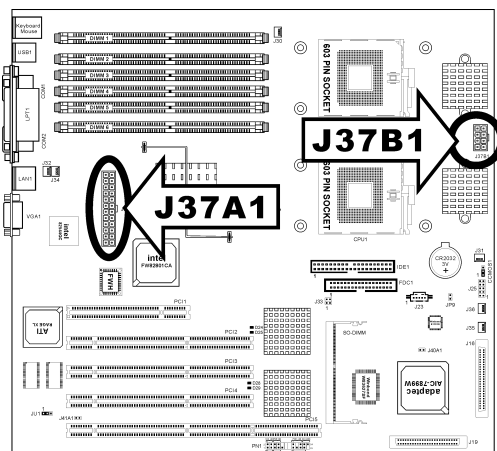

\* EPS = Enterpriser Power System, a specification for chassis power supplies.

**NOTE:** The auxiliary 12v power (J37B1) is necessary to support Intel Xeon CPUs. Failing to provide such extra power will result in the system's booting failure.

### 2.4.2. J30, J31, J32, J34, J35, J36: FAN Connectors

- J30: CPU0 Fan
- J31: CPU1 Fan
- J32: System3 Fan
- J34: System Fan (No tachometer support)
- J35: System2 Fan
- J36: System1 Fan

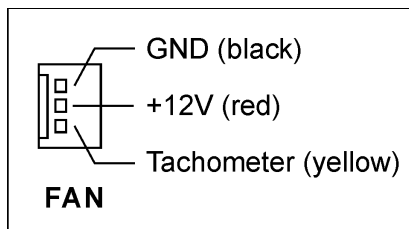
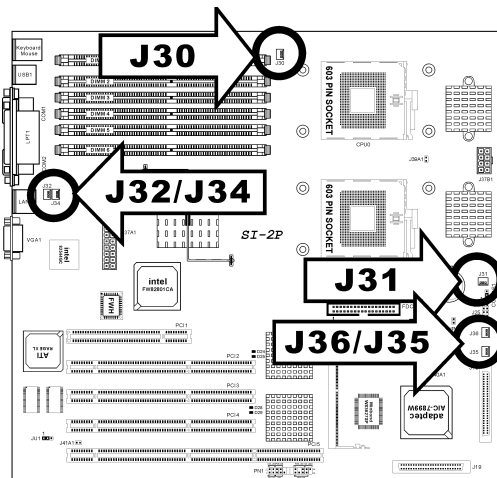

### 2.4.3. CCMOS1: CMOS Memory Clearing Header

This header uses a jumper cap to clear the CMOS memory. Short pin 2 and pin 3 only when you want to clear the CMOS memory. The default setting is pin 1 and pin 2 shorted for normal operation.

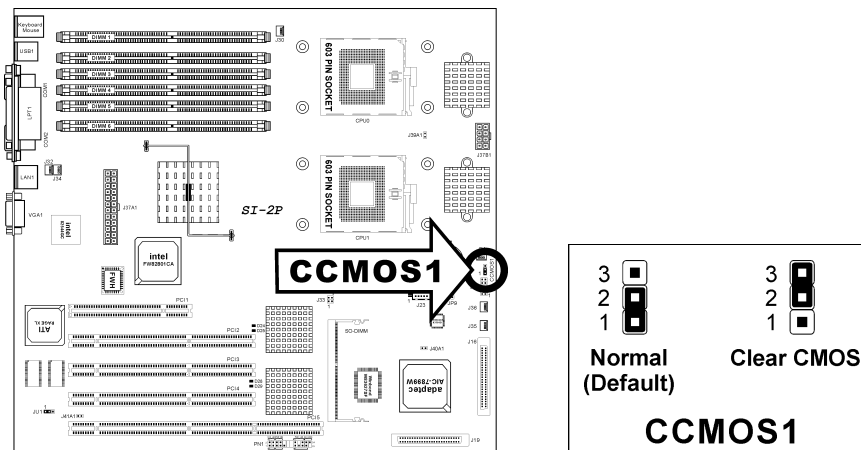

**ATTENTION:** Turn the system power off first (including the +5V standby power) before clearing the CMOS memory. Failing to do so may cause your system to work abnormally or malfunction.

#### 2.4.4. J39A1, J40A1, J41A1: Thermal Sensor Header

These connectors are a thermal sensor connector used for detecting the system environmental temperature. It may also be called a system temperature detector. You can attach one end of a two-threaded thermal cable to this header, and attach the other end of the thermal cable onto any heat source, such as VGA chipset's heatsink, or Hard Disk Drive.

- **J39A1:** System3 Temperature Sensor Connector
- **J40A1:** System2 Temperature Sensor Connector
- **J41A1:** System1 Temperature Sensor Connector

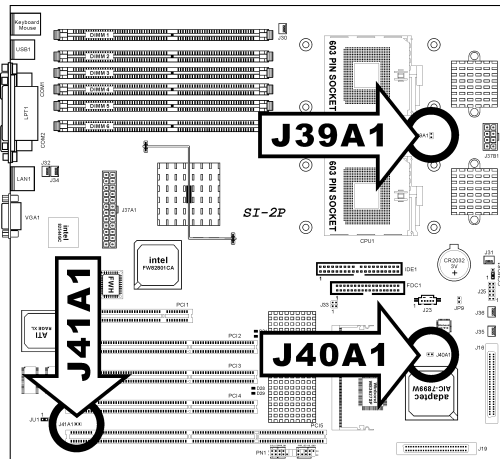

### 2.4.5. PN1 Header

This header is used for connecting switches and LED indicators on the chassis front panel.

Watch the power LED pin position and orientation. The mark “+” align to the pin in the figure below stands for positive polarity for the LED connection.

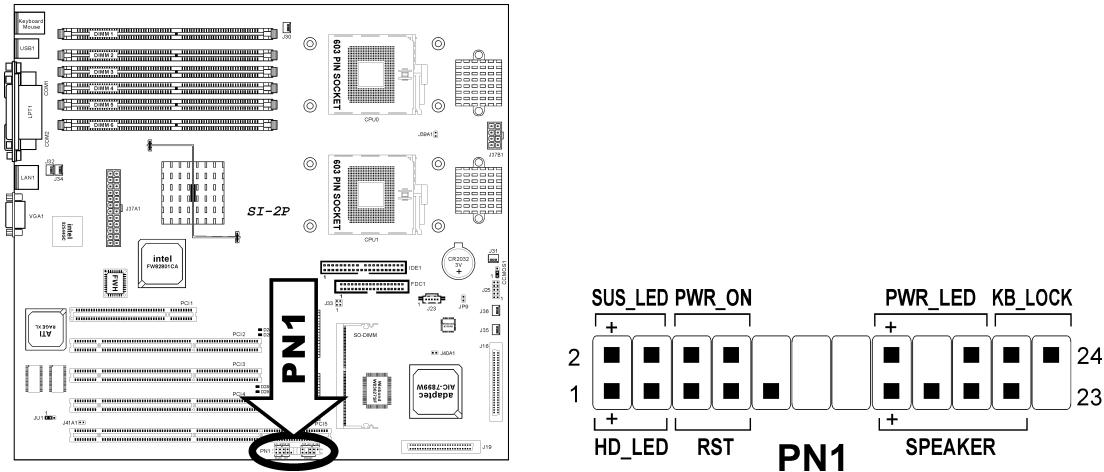

- **Pin 1-3: HDD\_LED**  
Connects to the HDD LED cable of chassis front panel.
- **Pin 5-7: RST**  
Connects to the Reset Switch cable of chassis front panel.
- **Pin 15-21: SPEAKER**  
Connects to the System Speaker cable of chassis.
- **Pin 2-4: SUS\_LED**  
Connects to the Suspend LED cable (if there is one) of chassis front panel.
- **Pin 6-8: PWR\_ON**  
Connects to the Power Switch cable of chassis front panel.
- **Pin 16-20: PWR\_LED**  
Connects to the Power LED cable of chassis front panel.
- **Pin 22-24: KB\_LOCK**  
Connects to the Keylock cable (if there is one) of chassis front panel.

### 2.4.6. FDC1 and IDE1 Connectors

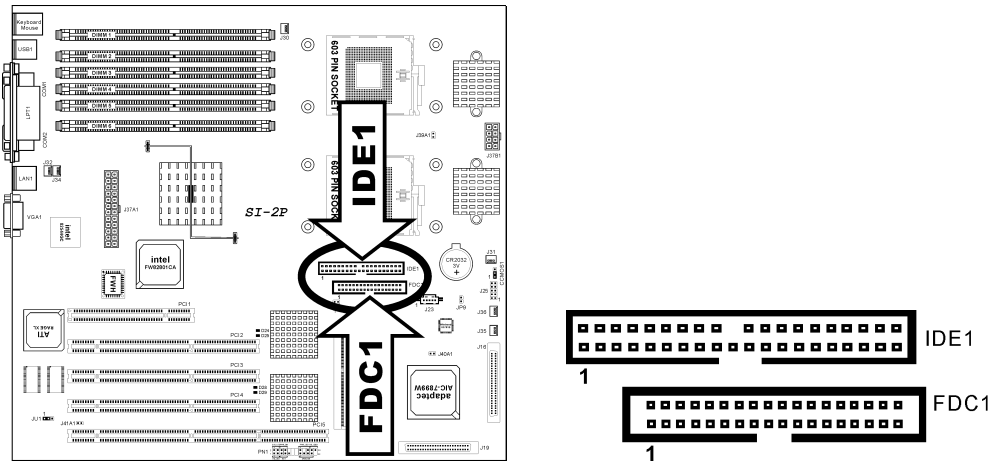

The FDC1 connector connects up to two floppy drives with a 34-wire, 2-connector floppy cable. Connect the single end at the longer length of ribbon cable to this FDC1, and the two connectors on the other end to the floppy disk drives. Generally you need only one floppy disk drive in your system.

The IDE1 port connects up to two IDE drives at Ultra ATA/100 mode by one 40-pin, 80-conductor, and 3-connector Ultra ATA/66 ribbon cables. Connect the single end (blue connector) at the longer length of ribbon cable to the IDE port on motherboard, and the other two ends (gray and black connector) at the shorter length of the ribbon cable to the connectors on hard drives.

**NOTE:** The red line on the ribbon cable should be aligned with pin-1 on this connector.

**2.4.7. J25: Smart Card Reader Connector**

This connector connects to the Smart Card Reader device through the front panel connector.

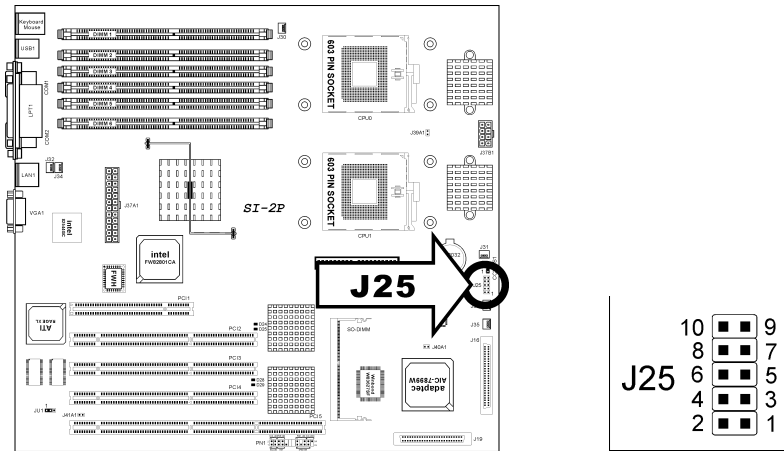

Pin	Pin Assignment	Pin	Pin Assignment
1	VCC	2	GND
3	SCPWR	4	SCRST
5	NC	6	NC
7	SCIO	8	NC
9	SCCLK	10	SCPSNT

**2.4.8. PCI Slots:**

**PCI1:** PCI 33 MHz/32 bit

**PCI2:** PCI-X 100 MHz/64 bit (Supports Hot Plug)

**PCI3:** PCI-X 133 MHz/64 bit (Supports Hot Plug)

**PCI4:** PCI-X 100 MHz/64 bit

**PCI5:** PCI-X 100 MHz/64 bit or Intel VxB Infiniband

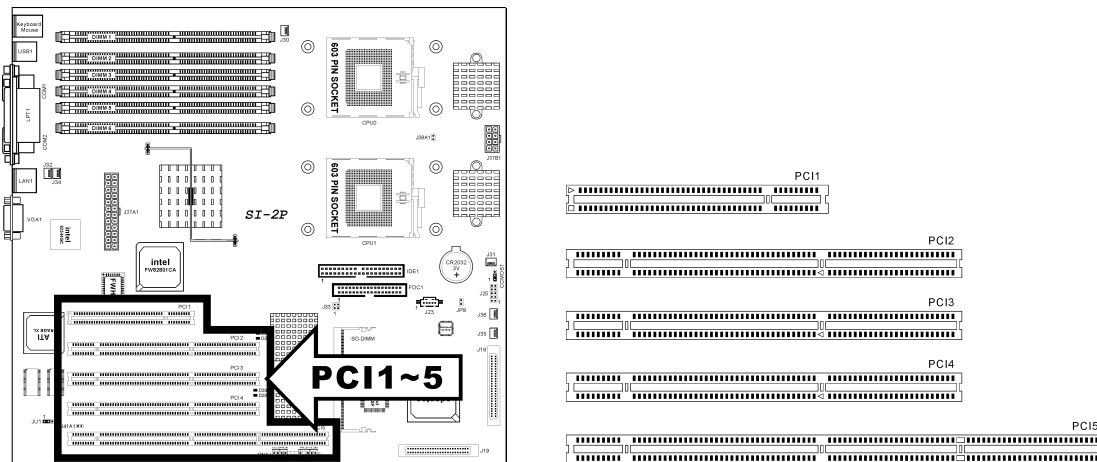

The PCI5 slot supports either “PCI-X 100 MHz/64 bit” or “Intel VxB Infiniband”. Please refer to the following figure for installation.

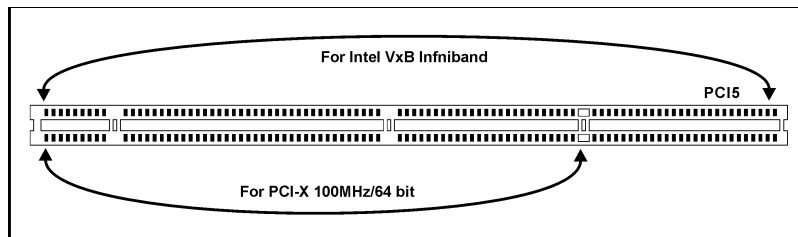



**2.4.9. J33: Hot Plug Switch Header**

This motherboard supports the “Hot Replace” function of “PCI-X Hot Plug Switch” in Windows 2000 or Windows XP, providing a non-stop maintenance to replace the PCI devices installed with no need to turn off the system power.

The available slots for this “Hot Replace” function are at PCI2 (Switch B) and PCI3 (Switch A).

**NOTE:** The driver for such devices must support this “Hot Plug” function.

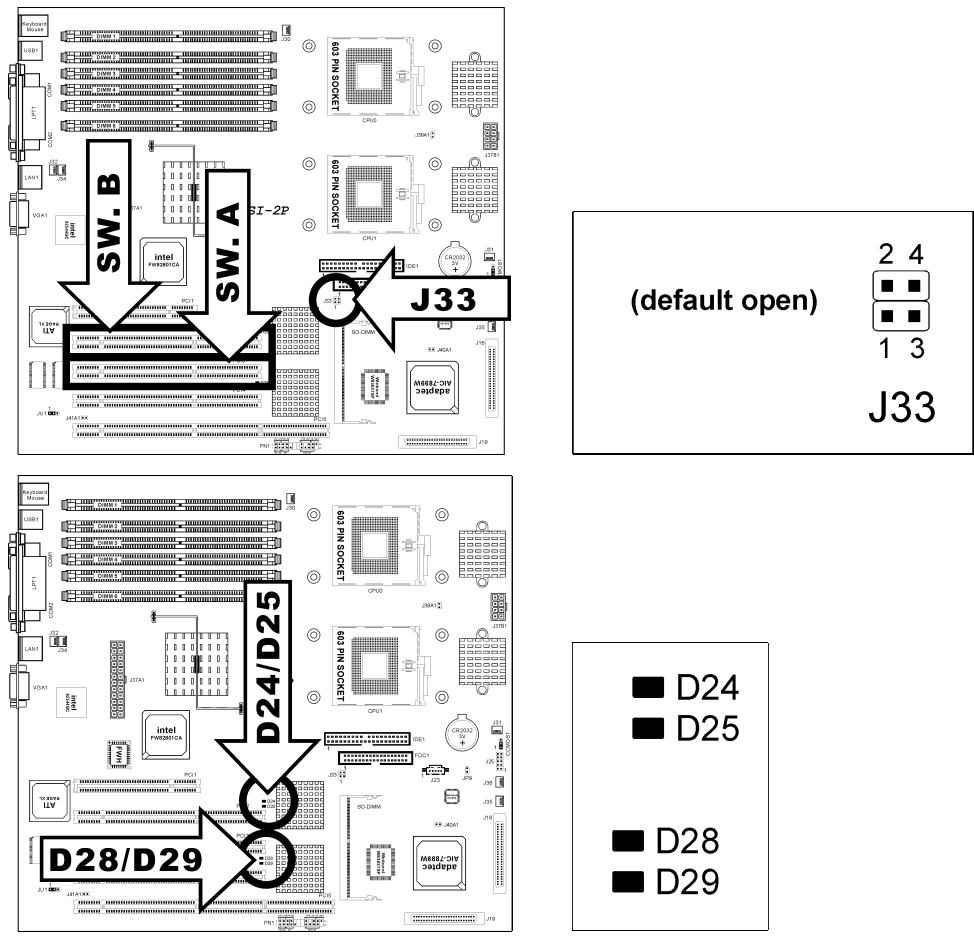

**To Hot-Plug the device installed on PCI2 slot (in Windows 2000 or Windows XP):**

1. Short pin 2-4 of J33 to enable Hot Plug Switch B.
2. The LED D25 lights off.
3. Remove the original PCI device.
4. Insert the new PCI device.
5. Make pin 2-4 of J33 open.
6. The LED D25 lights on.
7. The system detects this new device.

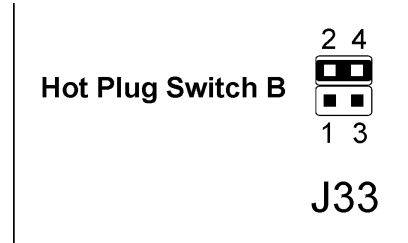
**To Hot-Plug the device installed on PCI3 slot (in Windows 2000 or Windows XP):**

1. Short pin 1-3 of J33 to enable Hot Plug Switch A.
2. The LED D29 lights off.
3. Remove the original PCI device.
4. Insert the new PCI device.
5. Make pin 1-3 of J33 open.
6. The LED D29 lights on.
7. The system detects this new device.

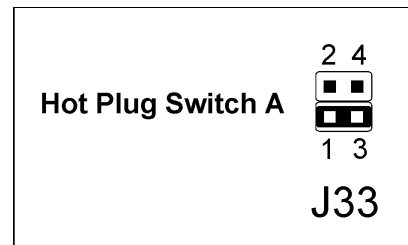

**NOTE:** The status LED D24 and D28 light on when abnormal status occurs on the devices installed on PCI2 and PCI3 slots.

### 2.4.10. JP9: Chassis Intrusion Header

This header is provided in the event that your chassis has a chassis intrusion feature (only certain chassis allow for this feature). If this feature is enabled, the system administrator will be notified if the chassis is opened.

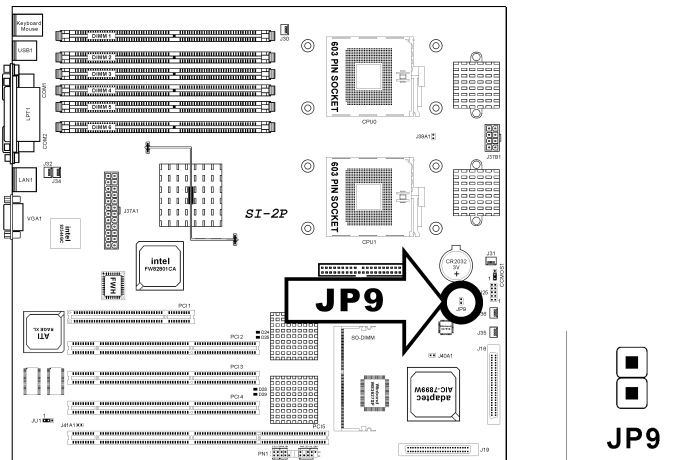

### 2.4.11. JU1: Onboard VGA Output Switch

This motherboard provides one onboard VGA output through the VGA1 connector at back panel by shorting pin-1 and pin-2 (default setting) of JU1 header. For external VGA card operation through PCI Slot, short pin-2 and pin-3 of JU1 header.

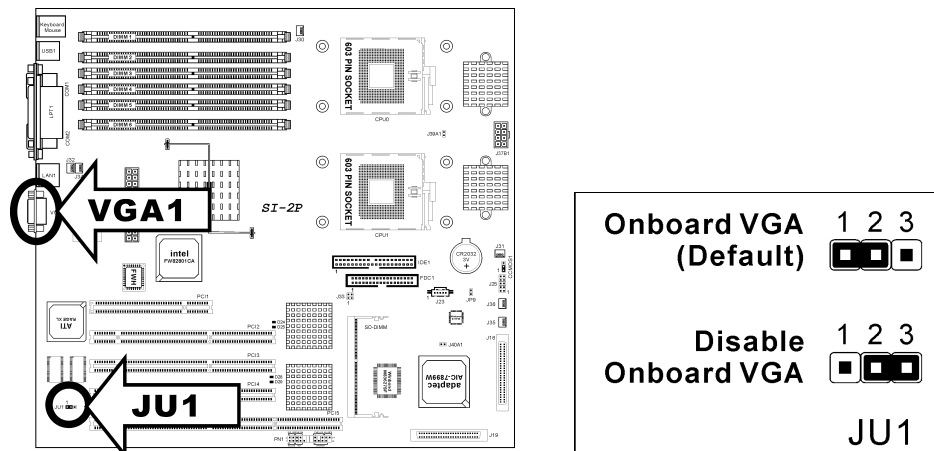

**2.4.12. SO-DIMM Connector**

The J16 and J19 connector can also be used to setup a RAID system by installing an optional Adaptec RAID card - 2005S (Raptor) to this connector.

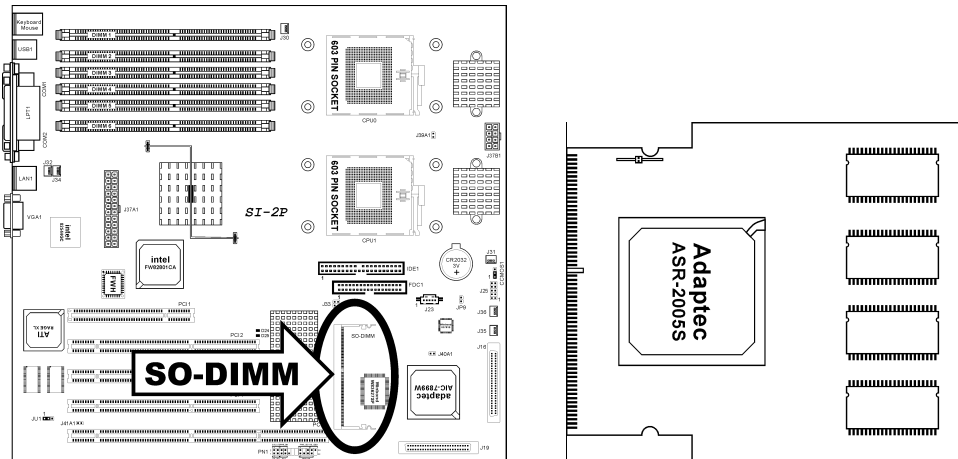

**2.4.13. J16/J19: Ultra 160 SCSI Channels Connector**

The onboard SCSI controller provides Ultra 160 SCSI channels through these J16 and J19 connector. Please refer to “SCSI Connection” section for detail.

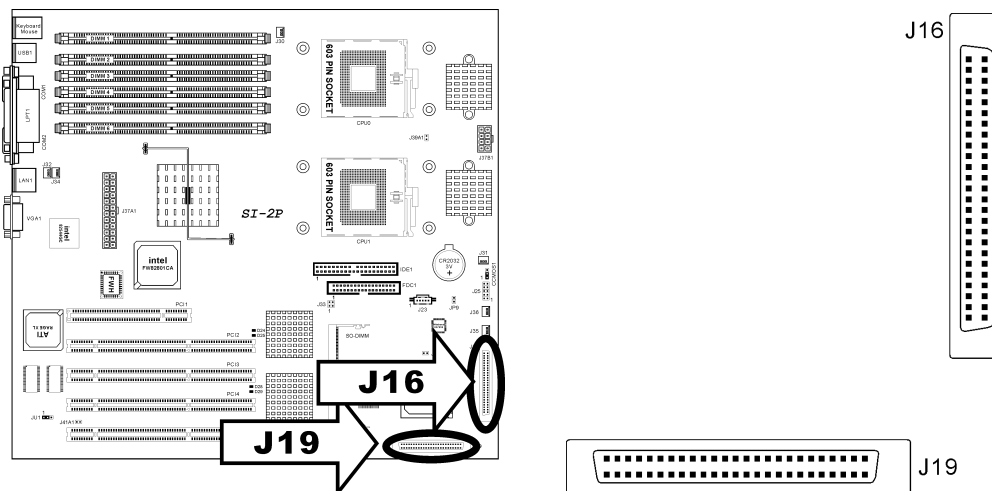

#### 2.4.14. Back Panel Connectors

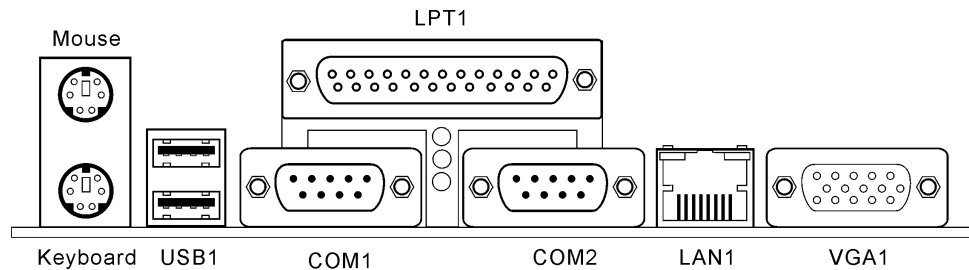

- **Mouse: PS/2 Mouse Connector:** Attach a PS/2 mouse to this 6-pin Din-connector.
- **Keyboard: PS/2 Keyboard Connector:** Attach a PS/2 keyboard connector to this 6-pin Din-connector. If you use an AT keyboard, you can go to a computer store to purchase an AT to ATX converter adapter. You can then connect your AT keyboard to this connector. We suggest you use a PS/2 keyboard for best compatibility.
- **USB Port Connectors:** This motherboard provides two onboard USB ports to attach USB devices such as scanner, digital speakers, monitor, mouse, keyboard, hub, digital camera, joystick etc.
- **Parallel Port Connector:** This parallel port is also called an “LPT” port because it usually connects to the printer. You can connect other devices that support this communication protocol, like an EPP/ECP scanner, etc.
- **Serial Port COM1 & COM2 Connector:** This motherboard provides two COM ports to connect external modem, mouse or other devices that support this communication protocol.
- **LAN Connector:** This motherboard carries an Intel 82544GC 10/100/1000Mb Ethernet Controller. You can connect your system to Local Area Network through this LAN connector.
- **VGA Port:** Connects to VGA signal input of monitor.

## 2.5. SCSI Connection

J16 and J19 connectors provide two 68-pin Ultra 160 SCSI channels. Each channel supports up to 15 devices (ID0~ID15) on a standard Ultra 160 SCSI LVD (Low Voltage Differential) cable, configuration up to 12 meters. In a point-to-point arrangement, cabling can extend 25 meters.

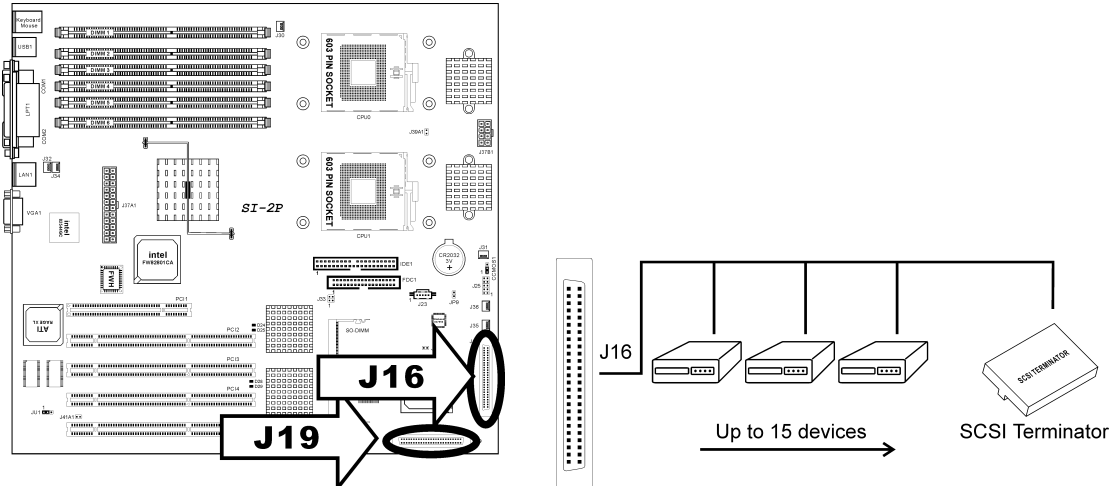

Each device has its own individual SCSI ID number, but none of the devices connected can use ID7, which is reserved for SCSI controller.

In order to prevent signal loss, a 68-pin twisted ribbon cable (LVD) with external SCSI terminator is necessary to connect Ultra 160 SCSI hard drive to this motherboard. All termination jumpers on the SCSI devices must be removed when using the external SCSI terminator.

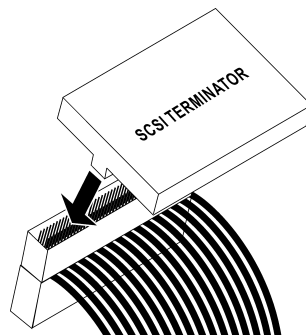

**IMPORTANT:** Each channel should have only one type of SCSI standard. A mixed setup with different standard on the same channel will decrease the performance to the slowest device.

### **2.5.1. Why the system hung when it detects AIC7xxx driver under RedHat 7.2**

The AC7xxx driver in RedHat 7.2 is old for AIC-7899W. Please use the following steps to do the installation:

1. Boot from RedHat 7.2 CD-ROM.
2. At boot prompt, type <expert noprobe>.
3. Select the appropriate language, country, and etc.
4. Choose “add devices” to list device drivers.
5. Select “new experimental ... aic7xxx\_mod”. The aic7xxxx\_mod will be loaded, instead of the regular aic7xxx driver.
6. Complete the installation.





## **Chapter 3. BIOS Setup**

---

The BIOS is a program located in a Flash Memory chip on the motherboard. This program will not be lost when you turn the computer off. This program is also referred to as the boot program. It is the only channel the hardware circuit has to communicate with the operating system. Its main function is to manage the setup of the motherboard and interface card parameters, including simple parameters such as time, date, hard disk drive, as well as more complex parameters such as hardware synchronization, and device operating mode. The computer will operate normally, or will operate at its best, only if all of these parameters are correctly configured through the BIOS.

**Don't change the parameters inside the BIOS unless you fully understand its meanings and consequences:** The parameters inside the BIOS are used to setup the hardware synchronization or the device-operating mode. If the parameters are not correct, they will produce errors, the computer will crash, and sometimes you will not even be able to boot the computer after it has crashed. We recommend that you do not change the parameters inside the BIOS unless you are very familiar with them. If you are not able to boot your computer anymore, please refer to the section “**Erase CMOS data**” in Chapter 2.

When you start the computer, the BIOS program controls it. The BIOS first operates an auto-diagnostic test called POST (Power On Self Test) for all of the necessary hardware. It then configures the parameters of the hardware synchronization, and detects all of the hardware. Only when these tasks are completed does it give up control of the computer to the next level, which is the operating system (OS). Since the BIOS is the only channel for hardware and software to communicate, it is the key factor for system stability, and in ensuring that your system performs at its best. After the BIOS has achieved the auto-diagnostic and auto-detection operations, it will display the following message:

**PRESS DEL TO ENTER SETUP**

**NOTE:** As the BIOS menu is being constantly improved to increase system stability and performance, the BIOS screens in this manual may not completely match those of your BIOS version.

### 3.1. Main Menu



#### Date (mm:dd:yy)

You can set the date in this item: month (mm), date (dd) and year (yy).

#### Time (hh:mm:ss)

You can set the time in this item: hour (hh), minute (mm) and second (ss).

#### Drive A

If you have installed the floppy disk drive here, then you can select the type of floppy drive it can support.

#### Halt On

You can select which type of error will cause the system to halt.

#### Memory Size

You can see your system memory list in the lower left box, it shows the *Base Memory*, *Extended Memory* and *total Memory size* configurations in your system. It is detected by the system during boot-up procedure.

### 3.1.1. IDE Primary Master / IDE Primary Slave

These items have a sub-menu to let you choose further options.

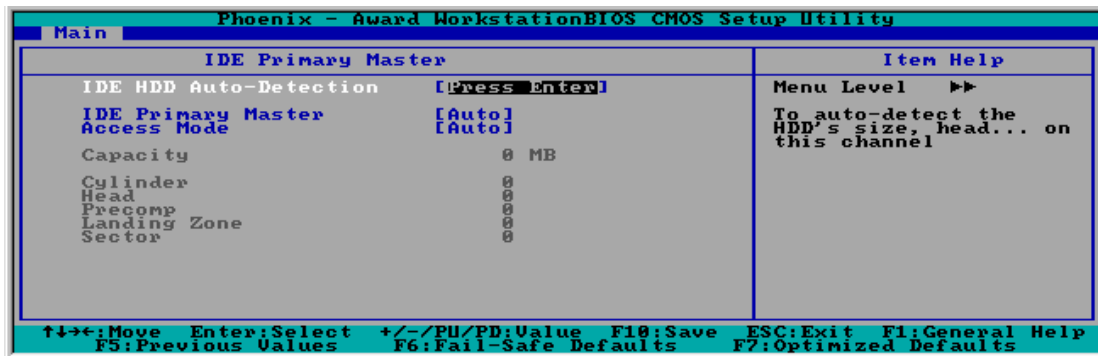

#### IDE HDD Auto-Detection

Press the <Enter> key for the BIOS to auto detect all detailed parameters of the hard disk drives (HDD). If auto detection is successful, the correct values will be shown in the remaining items of this menu.

**NOTE:** ❶ A new IDE HDD must be first formatted; otherwise it cannot be read/write. The basic step in using a HDD is to make a **HDD low-level format**, then run FDISK, and then FORMAT the drive. Most current HDDs have already been subjected to low-level format at the factory, so you can probably skip this operation. Remember though, the primary IDE HDD must have its partition set to active within the FDISK procedure.

❷ If you are using an old HDD that is already formatted, auto detection can not detect the correct parameters. You may need to do a low-level format or set the parameters manually, and then check if the HDD is working.

#### IDE Primary Master

Three settings are available: *Auto*, *Manual* and *None*. If you choose Auto, the BIOS will automatically check what kind of hard disk you are using. If you want to set the HDD parameters yourself, make sure you fully understand the meaning of the parameters, and be sure to refer to the manual provided by the HDD manufacturer to get the settings right.

#### Access Mode

Since old operating systems were only able to support HDDs with capacities no bigger than 528MB, any hard disk with more than 528MB was unusable. AWARD BIOS features a solution to this problem: you can, according to your operating system, choose four operating modes: CHS → LBA → LARGE → AUTO.

The HDD auto detection option in the sub-menu will automatically detect the parameters of your hard disk and the mode supported.

**CHS mode:** Standard normal mode supports hard disks of up to 528MB or less. This mode directly uses positions indicated by Cylinders (CYLS), Heads, and Sectors to access data.

**LBA (Logical Block Addressing) mode:** The earlier LBA mode can support HDD capacities of up to 8.4GB, and this mode uses a different method to calculate the position of disk data to be accessed. It translates Cylinders (CYLS), Heads and Sectors into a logical address where data is located. The Cylinders, Heads, and Sectors displayed in this menu do not reflect the actual structure of the hard disk. They are just reference values used to calculate actual positions. Currently, all high capacity hard disks support this mode and that is why **we recommend you use this mode**. Currently, the BIOS can support the INT 13h extension function, enabling the LBA mode to support hard disk drive capacities exceeding 8.4GB.

**LARGE Mode:** When the number of cylinders (CYLs) of the hard disk exceeds 1024 and DOS is not able to support it, or if your operating system does not support LBA mode, you should select this mode.

**AUTO:** Lets the BIOS detect your HDD access mode and make the decisions.

### Capacity

This item auto displays your HDD size. Note that this size is usually slightly greater than the size given by a disk checking program of a formatted disk.

**NOTE:** All the items below are available when you set the item “Primary IDE Master” to “Manual”.

### Cylinder

When disks are placed directly above one another along the shaft, the circular vertical “slice” consisting of all the tracks located in a particular position is called a cylinder. You can set the number of cylinders for a HDD. The minimum number you can enter is 0, the maximum number you can enter is 65536.

### Head

This is the tiny electromagnetic coil and metal pole used to create and read back the magnetic patterns on the disk (also called the read/write head). You can configure the number of read/write heads. The minimum number you can enter is 0, the maximum number you can enter is 255.

### Precomp

The minimum number you can enter is 0, the maximum number you can enter is 65536.

---

### SI-2P

---

---

**WARNING:** Setting a value of 65536 means no hard disk exists.

### **Landing Zone**

This is a non-data area on the disk's inner cylinder where the heads can rest when the power is turned off. The minimum number you can enter is 0, the maximum number you can enter is 65536.

### **Sector**

The minimum segment of track length that can be assigned to stored data. Sectors usually are grouped into blocks or logical blocks that function as the smallest units of data permit. You can configure this item to sectors per track. The minimum number you can enter is 0, the maximum number you can enter is 255.

## 3.2. Advanced Menu

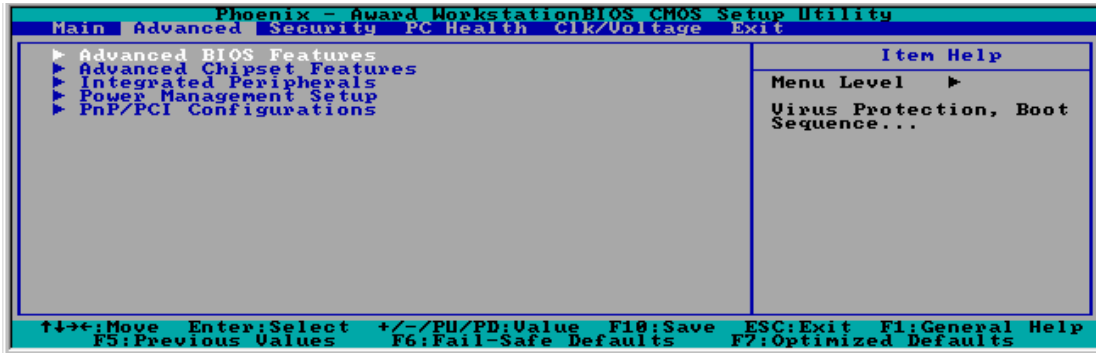

### 3.2.1. Advanced BIOS Features

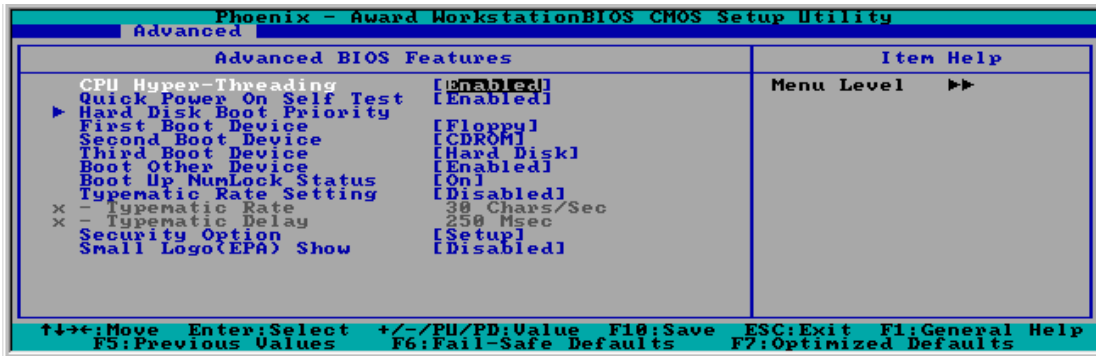

#### CPU Hyper-Threading

Leave this item to its default setting to enable the simultaneous multi-threaded (SMT) processor so as to make one physical processor looks like two logical processors to the OS and applications.

#### Quick Power On Self Test

After the computer has been powered on, the BIOS of the motherboard will run a series of tests in order to check the system and its peripherals. If the Quick Power on Self-Test feature is enabled, the BIOS will simplify the test procedures in order to speed up the boot process.

#### Hard Disk Boot Priority

This item allows you to select the booting priority of hard disks.

#### First Boot Device

When the computer boots up, the BIOS attempts to load the operating system from the

---

devices in the sequence selected in these items: floppy disk drive A, LS/ZIP devices, hard drive C, SCSI hard disk drive or CD-ROM.

**Second Boot Device:**

Its description is the same as the *First Boot Device*.

**Third Boot Device:**

Its description is same as the *First Boot Device*.

**Boot Other Device:**

Two options are available: Disabled or Enabled. The default setting is *Enabled*. This setting allows the BIOS to try to boot devices other than the three that are listed in the above First, Second and Third Boot Devices. If you set to Disabled, the BIOS will boot from only the three kinds of boot devices that are set above.

**Boot Up NumLock Status:**

**On:** At boot up, the Numeric Keypad is in numeric mode. (Default Settings)

**Off:** At boot up, the Numeric Keypad is in cursor control mode.

**Typematic Rate Setting**

This item allows you to adjust the keystroke repeat rate. When set to *Enabled*, you can set the two keyboard typematic controls that follow (*Typematic Rate* and *Typematic Rate Delay*). If this item is set to *Disabled*, the BIOS will use the default setting.

**Typematic Rate (Chars/Sec)**

When you press a key continuously, the keyboard will repeat the keystroke according to the rate you have set (Unit: characters/second).

**Typematic Delay (Msec)**

When you press a key continuously, if you exceed the delay you have set here, the keyboard will automatically repeat the keystroke according to a certain rate (Unit: milliseconds).

**Security Option**

This option can be set to System or Setup. The default setting is **Setup**. After you have created a password through PASSWORD SETTING, this option will deny access to your system (System) or modification of computer setup (BIOS Setup) by unauthorized users.

**SYSTEM:** When you choose System, a password is required each time the computer

boots up. If the correct password is not given, the system will not start.

**SETUP:** When you choose Setup, a password is required only when accessing the BIOS Setup. If the correct password is not given, you can't enter the BIOS setup menu.

To disable security, select *Set Supervisor Password* at main menu and then you will be asked to enter the password. Do not type anything and just press the <Enter> key and it will disable security. Once security is disabled, the system will boot and you can enter the *BIOS setup menu* freely

**NOTE:** Don't forget your password. If you forget the password, you will have to open the computer case and clear all information in the CMOS before you can start up the system. But by doing this, you will have to reset all previously set options.

### **Small Logo(EPA) Show:**

This item determines to show the EPA logo when booting.



### 3.2.2. Advanced Chipset Features

The Chipset Features Setup Menu is used to modify the contents of the buffers in the chipset on the motherboard. Since the parameters of the buffers are closely related to hardware, if the setup is not correct or is false, the motherboard will become unstable or you will not be able to boot up. If you don't know the hardware very well, use default values (i.e. use the LOAD SETUP DEFAULTS option). The only time you might consider making any changes is if you discover that data is being lost while using your system.

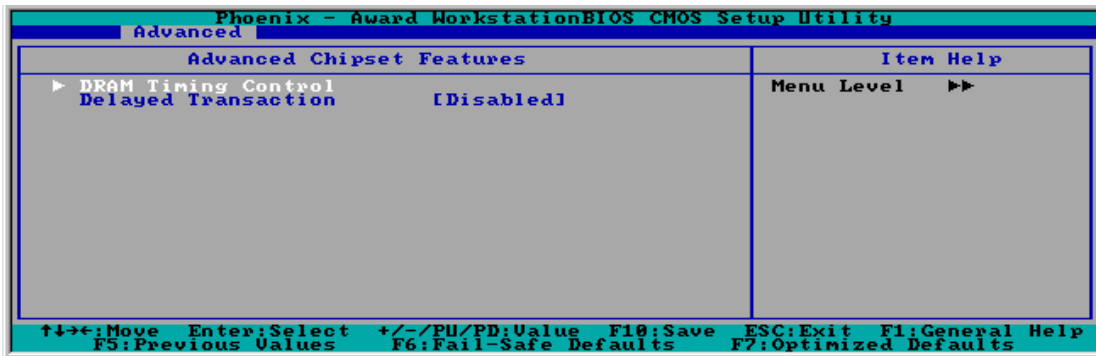

#### DRAM Timing Control

This item controls the DRAM timing. Press <Enter> key to enter its menu.

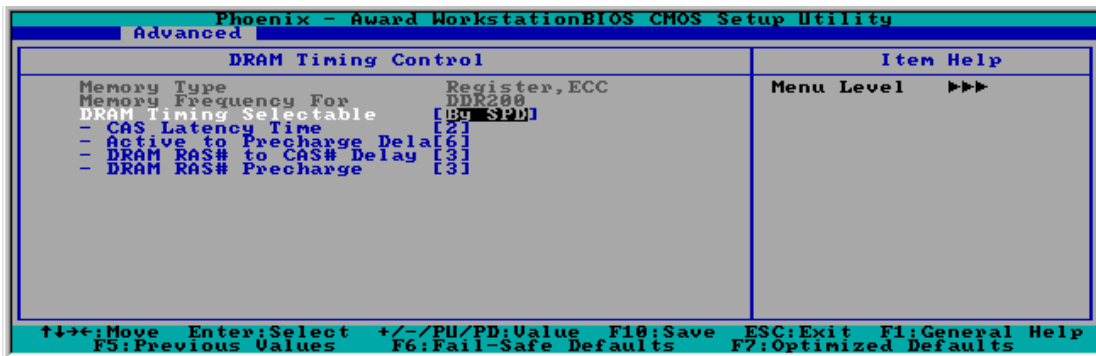

#### Memory Type

This item displays the type of memory module you are using.

#### Memory Frequency For

This item displays the frequency of memory module you are using.

#### DRAM Timing Selectable

This item sets the optimal timings for the following four items, depending on the

memory module you are using. The default setting “By SPD” configures these four items by reading the contents in the SPD (Serial Presence Detect) device. The EEPROM on the memory module stores critical parameter information about the module, such as memory type, size, speed, voltage interface, and module banks.

### **CAS Latency Time**

This item controls the latency between the DRAM read command and the time that the data becomes actually available.

### **Active to Precharge Delay**

The options are: 7, 6, and 5.

### **DRAM RAS# to CAS# Delay**

This item controls the latency between the DRAM active command and the read/write command. The options are: 2 and 3.

### **DRAM RAS# Precharge**

This item controls the idle clocks after issuing a precharge command to the DRAM.

### **Delayed Transaction**

Two options are available: Enabled and Disabled. The default setting is *Disabled*. Set the option to enabled or disabled PCI 2.1 features including passive release and delayed transaction for the chipset. This function is used to meet the latency of PCI cycles to or from the ISA bus. This option must be enabled to provide PCI 2.1 compliance. If you have an ISA card compatibility problem, you can try to enable or disable this option for optimal results.

### 3.2.3. Integrated Peripherals

In this menu, you can change the onboard I/O device, I/O port address and other hardware settings.

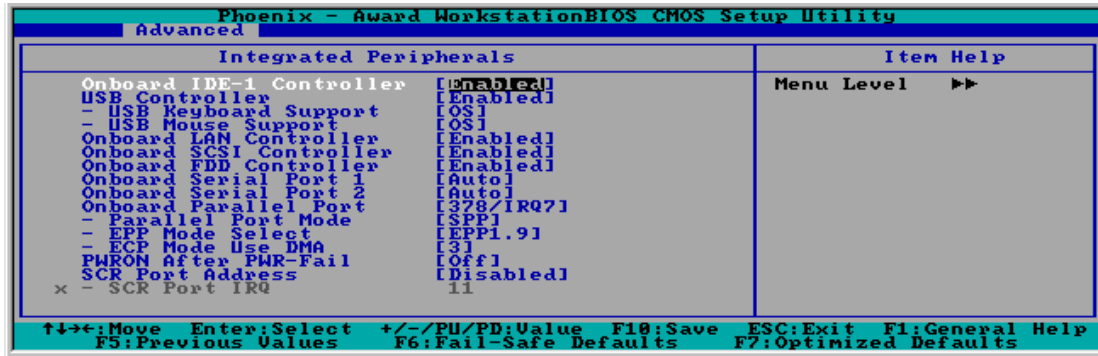

#### Onboard IDE-1 Controller

The onboard IDE 1 controller can be set as Enabled or Disabled. The default setting is **Enabled**. The integrated peripheral controller contains an IDE interface with support for two IDE channels. If you choose *Disabled*, it will affect the settings of four items not available. For example, if you disabled the *Onboard IDE-1 Controller*, you will also disable the *Master/Slave Drive PIO Mode* and *Master/Slave Drive Ultra DMA*.

#### USB Controller

Two options are available: Enabled and Disabled. The default setting is **Enabled**. This motherboard provides two Universal Serial Bus (USB) ports to support USB devices. If you don't want to use USB devices, set it to *Disabled*, then the item *USB Keyboard Support & USB Mouse Support* will also be disabled.

#### USB Keyboard Support

Two options are available: OS and BIOS. The default setting is **OS**. If you want to use USB keyboard in DOS environment, please set it to BIOS.

#### USB Mouse Support

Two options are available: OS and BIOS. The default setting is **OS**. If you want to use USB mouse in DOS environment, please set it to BIOS.

#### Onboard LAN Controller

This item enables or disables the onboard LAN controller.

### **Onboard SCSI Controller**

This item enables or disables the onboard SCSI controller.

### **Onboard FDD Controller**

Two options are available: Enabled and Disabled. The default setting is *Enabled*. You can enable or disable the onboard FDD controller.

### **Onboard Serial Port 1**

This is used to specify the I/O address and IRQ of Serial Port 1. Six options are available: Disabled → 3F8/IRQ4 → 2F8/IRQ3 → 3E8/IRQ4 → 2E8/IRQ3 → AUTO. The default setting is *3F8/IRQ4*.

### **Onboard Serial Port 2**

This is used to specify the I/O address and IRQ of Serial Port 2. Six options are available: Disabled → 3F8/IRQ4 → 2F8/IRQ3 → 3E8/IRQ4 → 2E8/IRQ3 → AUTO. The default setting is *2F8/IRQ3*.

### **Onboard Parallel Port**

Sets the I/O address and IRQ of the onboard parallel port. Four options are available: Disable → 378/IRQ7 → 278/IRQ5 → 3BC/IRQ7. Default setting is *378/IRQ7*.

### **Parallel Port Mode**

Four options are available: SPP → EPP → ECP → ECP+EPP. The default setting is *SPP* mode.

### **EPP Mode Select**

Two options are available: EPP1.7 → EPP1.9. The default setting is *EPP 1.7*. When the mode selected for the parallel port mode is EPP, the two EPP version options are available.

### **ECP Mode Use DMA**

Two options are available: 1 → 3. The default setting is 3. When the mode selected for the parallel port mode is ECP, the DMA channel selected can be Channel 1 or Channel 3.

### **PWRON After PWR-Fail**

*This item sets the system action after a power failure.*

**SCR Port Address**

This item sets the I/O address and IRQ of the onboard SCR (Smart Card Reader) port.

**SCR Port IRQ**

After enabling the SCR port, here you can set the IRQ for SCR port.

### 3.2.4. Power Management Setup

This menu allows you to set up the power management in order to reduce power consumption.

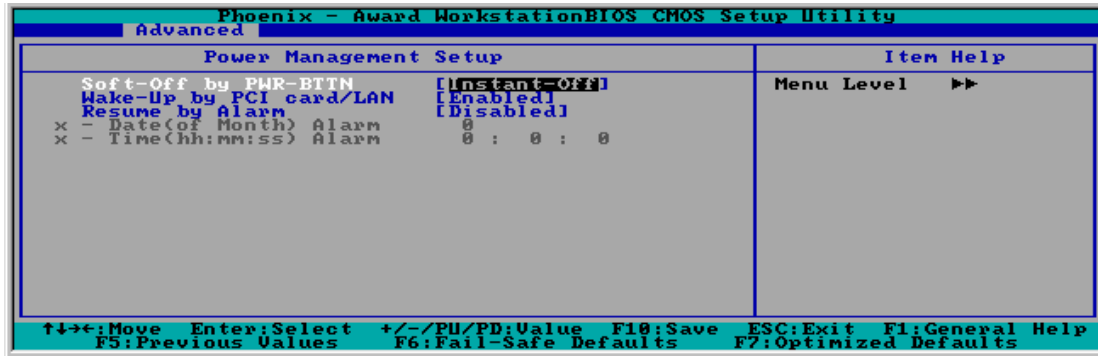

#### Soft-Off by PWR-BTTN

Two options are available: Instant-off and Delay 4 Sec.. The default setting is *Instant-off*. Pressing the power button for more than four seconds forces the system to enter the Soft-Off state when the system has “hung”.

#### Wake-Up by PCI card/LAN

Two options are available: Enabled and Disabled. Default setting is *Disabled*. This item can let you wake-up your computer by PCI devices. For instance, if you had installed a PCI LAN card with Wake-Up on LAN capability, then you could wake-up your computer from another computer via a network by sending a wake-up frame signal. This feature also allows the PCI card built-in hardware function to support the wake up function without special cables connected to the motherboard.

**NOTE:** This feature needs a specific network interface (optional). Also your ATX power supply +5V standby power must be at least 720mA compatible.

#### Resume by Alarm

Two options are available: Enabled and Disabled. Default setting is *Disabled*. The RTC alarm can turn on the system. You can set Date (of month) and Time (hour, minute, and second) when you set this item to *Enabled*.

### 3.2.5. PnP/PCI Configurations

This section describes configuring the PCI bus system. PCI, or Personal Computer Interconnect, is a system which allows I/O devices to operate at speeds nearing the speed the CPU itself uses when communicating with its own special components. This section covers some very technical items and it is strongly recommended that only experienced users should make any changes to the default settings.

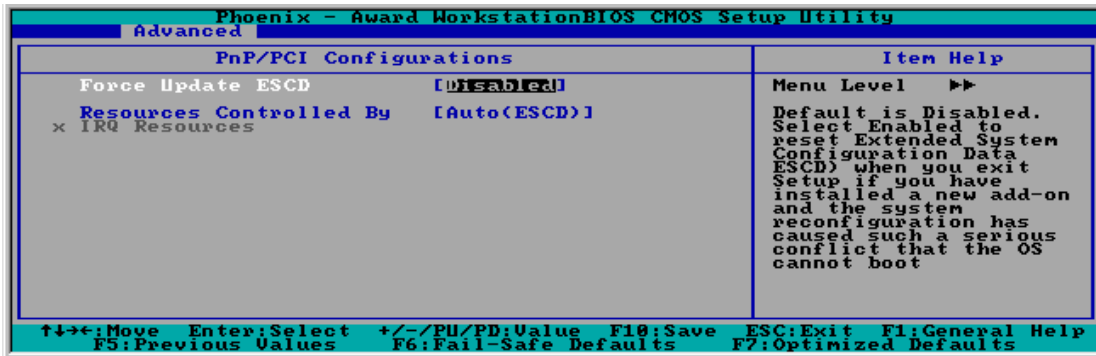

#### Force Update ESCD

If you want to clear ESCD data next time you boot up, and ask the BIOS to reset the settings for the Plug & Play ISA Card and the PCI Card, select Enabled. But the next time you boot up, this option will automatically be set as Disabled.

#### Resources Controlled By

The Award Plug and Play BIOS has the capability to automatically configure all of the boot and Plug and Play compatible devices. If you select *Auto (ESCD)*, The IRQ Resources item will be disabled, as the BIOS automatically assigns them. But if you have trouble in assigning the interrupt resources automatically, you can select *Manual* to set which IRQ is assigned to PCI PnP cards.

The following figure shows you the screen of IRQ resources. Each item has two options: PCI Device and Reserved. The default setting is *PCI Device*.

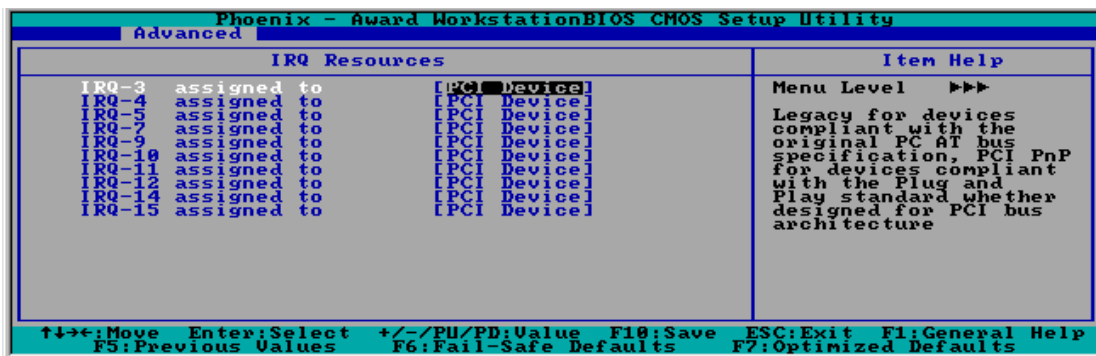

### 3.3. Security Menu

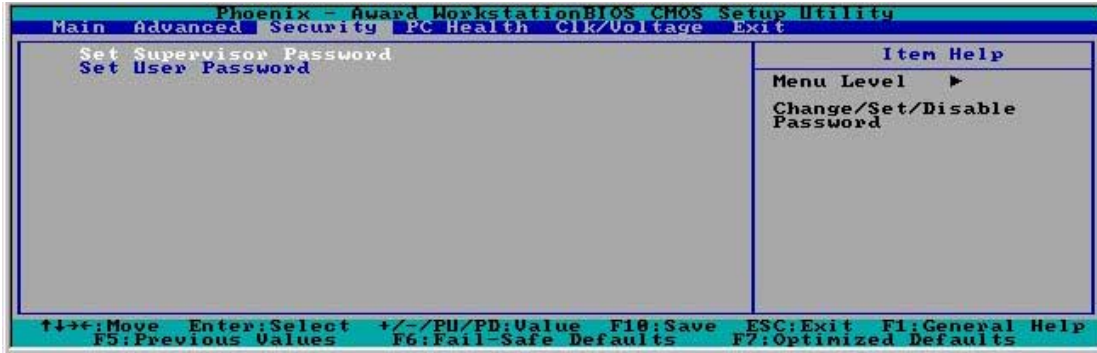

#### Set Supervisor Password

This option protects the BIOS configuration or restricts access to the computer itself. The Supervisor Password is used to protect the stored CMOS options from being changed by unauthorized users.

#### Set User Password

This option protects the BIOS configuration or restricts access to the computer itself. The User Password requires all users to enter a password in order to use the system, and/or enter the BIOS setup (but can't change its contents).



### 3.4. PC Health Menu

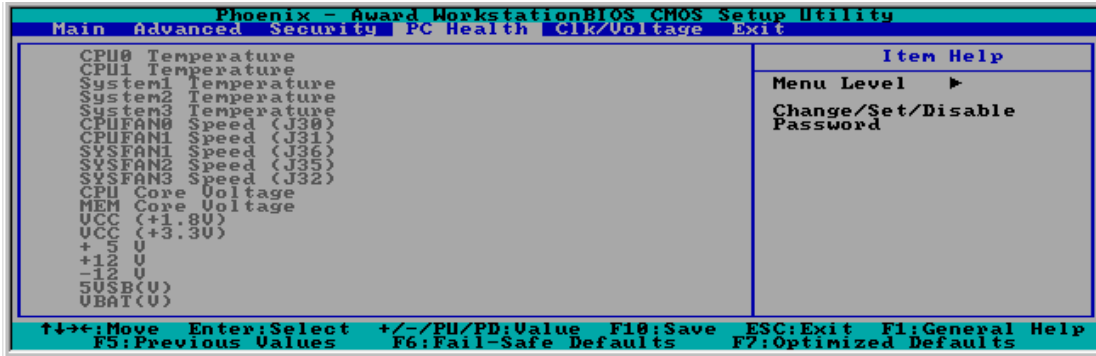

These unchangeable items list the current status of the CPU and environment temperatures, fan speeds, and system power voltage. (The J34 header does not support speed monitoring.)

**NOTE:** The hardware monitoring features for temperatures, fans and voltages will occupy the I/O address from 294H to 297H. If you have a network adapter, sound card or other add-on cards that might use those I/O addresses, please adjust your add-on card I/O address to avoid using these addresses.

### 3.5. Clk/Voltage Menu

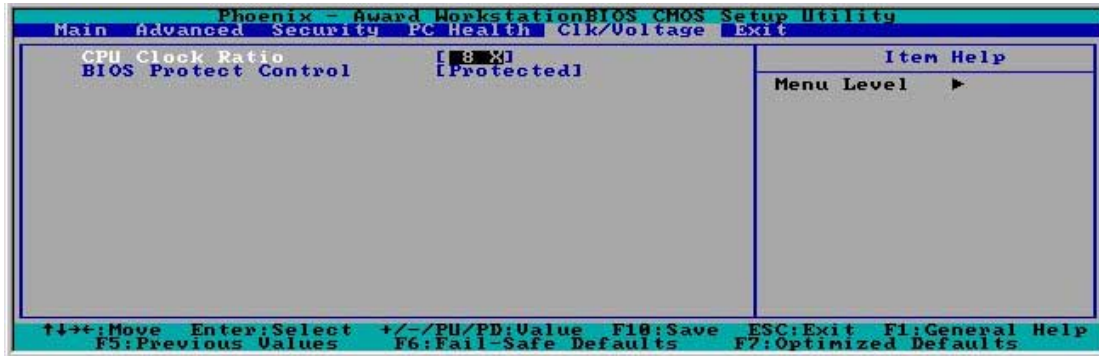

#### CPU Clock Ratio

This option selects the CPU clock ratio. Please type in the correct multiple for your CPU.

#### BIOS Protect Control

This option protects for accidentally BIOS writing attempt.

**NOTE:** Set this item to “Unprotected” when flashing the BIOS.

## 3.6. Exit Menu

Once you have made all your selections in the previous BIOS setup menu, you have to save the settings and exit the setup menu. Select the Exit Menu in the menu bar to show the following menu:

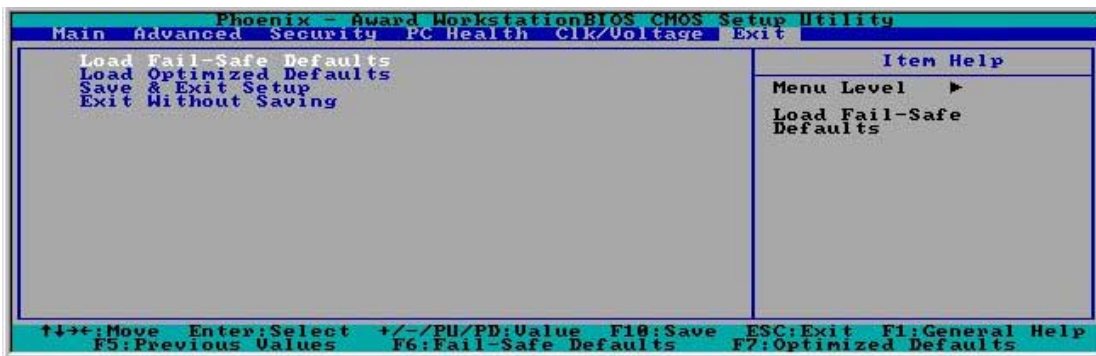

**NOTE:** Pressing <ESC> does not exit this menu. You have to select one of the options in this menu, such as “Exit Without Saving” to exit the menu without saving your previous settings.

### Load Fail-Safe Defaults

This option loads the BIOS default values for the most stable, minimal-performance system operations.

### Load Optimized Defaults

This option loads the BIOS default values that are factory settings for optimal-performance system operations.

### Save & Exit Setup

This option saves your selections and exits the setup menu.

### Exit Without Saving

This option exits the setup menu without saving any change.



## Chapter 4. SCSI Utility

To enter the SCSI configuring menu, reboot the system, press <Ctrl> and <A> key when the following message appears:

**Press <Ctrl> <A> for SCSISelect(TM) Utility**

The following screen appears. Select the channel you want to enter the SCSI configuring menu.

```
AIC-7899 A at slot 0A 06:02:00
AIC-7899 A at slot 0A 06:02:01
```

Move the <Up> or <Down> arrow key to select the channel your SCSI devices attached, and then press <Enter> key to enter. Press <Esc> key will exit this menu.

The following screen appears. Here in this option, you can configure the SCSI controller, or run the SCSI Disk Utilities.

```
AIC-7899 A at slot 0A, 06:02:00

Would you like to configure the SCSI controller, or run the
SCSI Disk Utilities? Select the option and press <Enter>.

Options

Configure/View SCSI Controller Settings
SCSI Disk Utilities
```

Move the <Up> or <Down> arrow key to select the option you want and press <Enter> key to enter. Press <Esc> key will exit this menu.

```

AIC-7899 A at slot 0A, 06:02:00

Configuration

SCSI Bus Interface Definitions
SCSI Controller ID.....7
SCSI Controller Parity.....Enabled
SCSI Controller Termination.....Enabled

Additional Options
Boot Device Configuration.....Press <Enter>
SCSI Device Configuration.....Press <Enter>
Advance Configuration.....Press <Enter>

<F6> - Reset to SCSI Controller Defaults

BIOS Informaton

Interrupt (IRQ) Channel.....11
I/O Port Address.....B000h

```

This is the “Configure/View SCSI Controller Settings” menu. Carefully configure your settings. Press <F6> key will reset to SCSI Controller defaults.

```

AIC-7899 A at slot 0A, 06:02:00

Select SCSI Disk and press <Enter>

SCSI ID #0:          No Device
SCSI ID #1:          No Device
SCSI ID #2:          No Device
SCSI ID #3:          No Device
SCSI ID #4:          No Device
SCSI ID #5:          No Device
SCSI ID #6:          No Device
SCSI ID #7:          Adaptec AIC-7899
SCSI ID #8:          No Device
SCSI ID #9:          No Device
SCSI ID #10:         No Device
SCSI ID #11:         No Device
SCSI ID #12:         No Device
SCSI ID #13:         No Device
SCSI ID #14:         No Device
SCSI ID #15:         No Device

```

This is the “SCSI Disk Utilities” menu. SCSI ID #7 is reserved for SCSI controller only.

## Chapter 5. Driver Installation

After all the hardware has been installed, you must first install the operating system and then the software drivers. The necessary drivers are all included on the Drivers & Utilities CD that came packaged with your motherboard. After inserting this CD into your CD-ROM drive, the display shown in the following figure should appear. (If not, click on the “My Computer” icon and then on the icon representing your CD-ROM drive. Finally, double click on the “Launch” icon.)

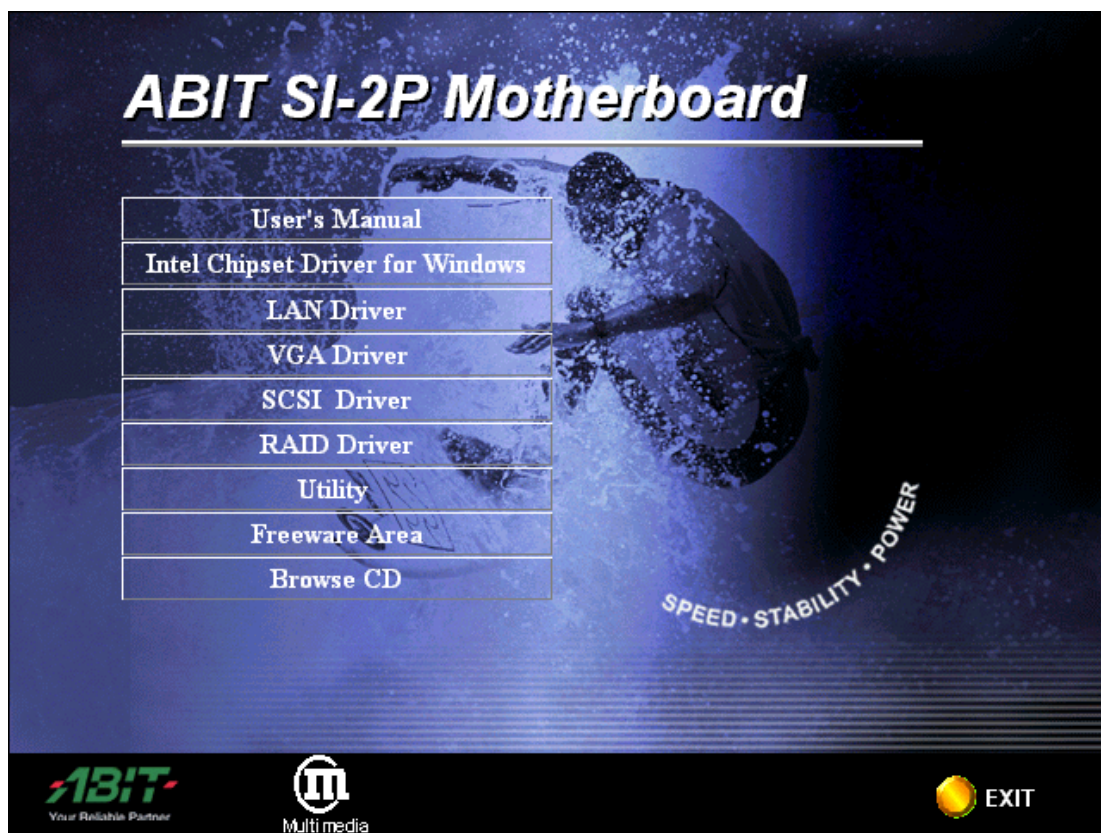

**NOTE:** The Support CD contents are subject to change at any time without notice.

Please follow the on-screen instructions to complete the installation. After installing each item, you must reboot the system before moving on to the next item on the list.

## 5.1. Setup Items

- **User's Manual**  
View the user's manual in PDF.
- **Intel Chipset Driver for Windows**  
Install Intel chipset driver for Windows Operating System.
- **LAN Driver**  
Install the drivers needed to run Fast Ethernet controller. The operating system supported are Windows, Windows XP 64-bit, Linux, Netware, and FreeBSD.
- **VGA Driver**  
Install VGA graphic driver for Windows Operating System.
- **SCSI Driver**  
Install SCSI driver for Windows Operating System.
- **RAID Driver**  
Install RAID driver for WinXP, Win2000, Win98, Netware Operating System.
- **Utility**  
Click to enter the sub-screen for installing DirectX8.1, Acrobat Reader, Winbond Hardware Doctor, and Award Flash utility software.
- **Freeware Area**  
There are free softwares like Norton Antivirus, 3Deep Color, WinDVD, and Buzzsoft for you to install.
- **Browse CD**  
To browse the contents of this CD-ROM.
- **Exit**  
Exit the CD setup Items Menu.