

SG-80DC

Motherboard
Intel Pentium 4
Socket 775

Installation Instruction

Copyright and Warranty Notice

The information in this document is subject to change without notice and does not represent a commitment on part of the vendor, who assumes no liability or responsibility for any errors that may appear in this manual.

No warranty or representation, either expressed or implied, is made with respect to the quality, accuracy or fitness for any particular part of this document. In no event shall the manufacturer be liable for direct, indirect, special, incidental or consequential damages arising from any defect or error in this manual or product.

Product names appearing in this manual are for identification purpose only and trademarks and product names or brand names appearing in this document are the property of their respective owners.

This document contains materials protected under International Copyright Laws. All rights reserved. No part of this manual may be reproduced, transmitted or transcribed without the expressed written permission of the manufacturer and authors of this manual.

If you do not properly set the motherboard settings, causing the motherboard to malfunction or fail, we cannot guarantee any responsibility.

Contents

1. Introduction	1-1
1.1 Features & Specifications	1-1
1.2 Motherboard Layout.....	1-3
2. Hardware Setup	2-1
2.1 Choosing a Computer Chassis	2-1
2.2 Installing Motherboard	2-1
2.3 Checking Jumper Settings	2-2
2.3.1 CMOS Memory Clearing Header and Backup Battery	2-3
2.4 Connecting Chassis Components.....	2-5
2.4.1 ATX Power Connectors	2-5
2.4.2 FAN Power Connectors	2-5
2.4.3 Front Panel Switches & Indicators Headers.....	2-6
2.5 Installing Hardware.....	2-7
2.5.1 CPU Socket 775	2-7
2.5.2 DDR Memory Slots	2-10
2.5.3 Floppy and IDE Disk Drive Connectors	2-11
2.5.4 Serial ATA Connectors	2-12
2.5.5 Accelerated Graphics Port Slot.....	2-13
2.5.6 PCI Add-on Slots.....	2-13
2.6 Connecting Optional Devices	2-14
2.6.1 Additional USB 2.0 Port Headers.....	2-14
2.6.2 Internal Audio Source Connector	2-14
2.6.3 Front Panel Audio Connection Header	2-15
2.7 Connecting I/O Devices.....	2-16

3. BIOS Setup..... 3-1

4. Driver & Utility 4-1

5. Appendix 5-1

 5.1 Troubleshooting (How to Get Technical Support?).....5-1

 5.1.1 Q & A.....5-1

 5.1.2 Technical Support Form5-3

1. Introduction

1.1 Features & Specifications

CPU

- LGA775 Socket for Intel® Pentium D/ Pentium 4/ Celeron Processors with 800/533 MHz FSB
- Compatible with Intel® P4-05A processors
- Supports Intel® Hyper-Threading / XD-bit / EM64T Technology

Chipset

- Northbridge: SIS 661FX
- Southbridge: SIS 964

Memory

- Two 184-pin DIMM slots
- Supports DDR 400 Un-buffered Non-ECC memory
- Supports maximum memory capacity up to 2GB

Graphics

- Integrated SIS Mirage Graphics GPU high performance 256-bit 3D engine and 2D Accelerator

Serial ATA

- 2x SATA 1.5Gb/s Supports SATA RAID 0, RAID 1

LAN

- Onboard 10/100M PHY

Audio

- Onboard 5.1 channels Audio CODEC

Expansion Slots

- 1x AGP 8X slot
- 3x PCI slots

Internal I/O Connectors

- 1x Floppy port
- 1x UDMA 133/100/66/33 connector
- 2x SATA 1.5Gb/s connectors
- 2x USB 2.0 headers
- 1x AUDIO1 header
- 1x CD_IN header

Rear Panel I/O

- 1x PS/2 Mouse connector

- 1x PS/2 Keyboard connector
- 1x Serial Port
- 1x Parallel Port
- 1x VGA connector
- 4x USB 2.0 connectors
- 1x RJ-45 LAN Connector
- 1x Audio connector (Line-out, Line-in, MIC-in)

Miscellaneous

- ATX form factor (244mm x 244mm)

※ **Specifications and information contained herein are subject to change without notice.**

1.2 Motherboard Layout

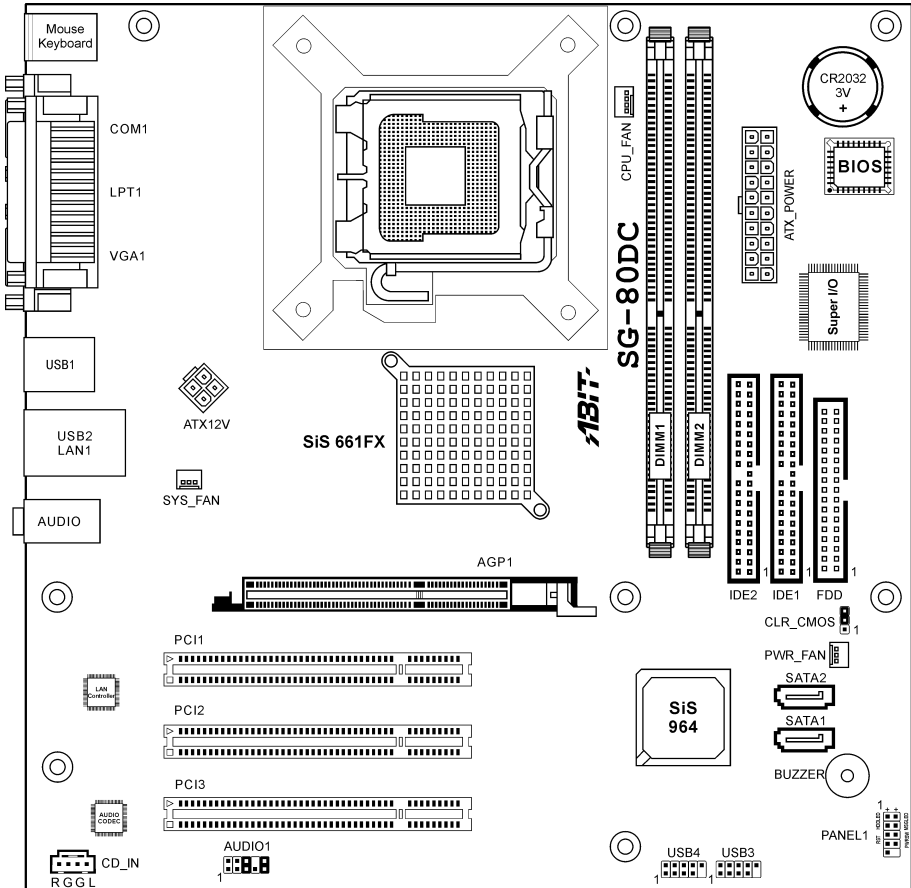

2. Hardware Setup

In this chapter we will elaborate all the information you need upon installing this motherboard to your computer system.

- ✘ **Always power off the computer and unplug the AC power cord before adding or removing any peripheral or component. Failing to do so may cause severe damage to your motherboard and/or peripherals. Plug in the AC power cord only after you have carefully checked everything.**

2.1 Choosing a Computer Chassis

- This motherboard carries an mATX form factor of 244 x 244 mm. Choose a chassis big enough to install this motherboard.
- As some features for this motherboard are implemented by cabling connectors on the motherboard to indicators and switches or buttons on the chassis, make sure your chassis supports all the features required.
- If there is possibility of adopting some more hard drives, make sure your chassis has sufficient power and space for them.
- Most chassis have alternatives for I/O shield located at the rear panel. Make sure the I/O shield of the chassis matches the I/O port configuration of this motherboard. You can find an I/O shield specifically designed for this motherboard in its package.

2.2 Installing Motherboard

Most computer chassis have a base with many mounting holes to allow the motherboard to be securely attached, and at the same time, prevent the system from short circuits. There are two ways to attach the motherboard to the chassis base:

1. use studs, or
2. use spacers

In principle, the best way to attach the board is to use studs. Only if you are unable to do this should you attach the board with spacers.

Line up the holes on the board with the mounting holes on the chassis. If the holes line up and there are screw holes, you can attach the board with studs. If the holes line up and there are only slots, you can only attach with spacers. Take the tip of the spacers and insert them into the slots. After doing this to all the slots, you can slide the board into position aligned with slots. After the board has been positioned, check to make sure everything is OK before putting the chassis back on.

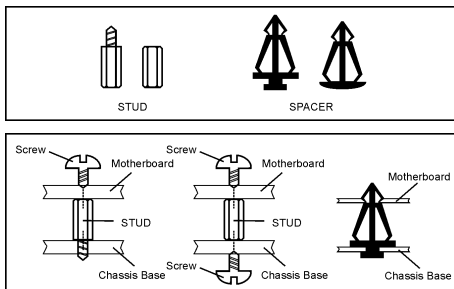

To install this motherboard:

1. Locate all the screw holes on the motherboard and the chassis base.
2. Place all the studs or spacers needed on the chassis base and have them tightened.
3. Face the motherboard's I/O ports toward the chassis's rear panel.
4. Line up all the motherboard's screw holes with those studs or spacers on the chassis.
5. Install the motherboard with screws and have them tightened.

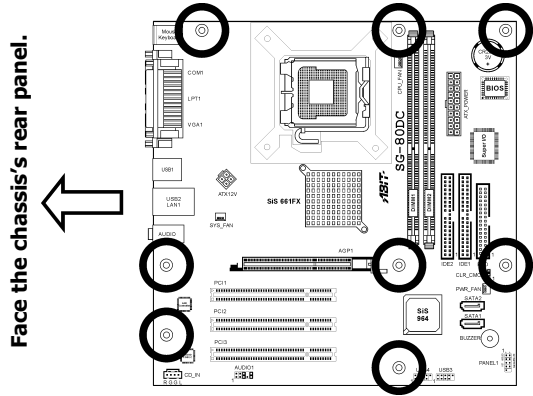

※ To prevent shorting the PCB circuit, please REMOVE the metal studs or spacers if they are already fastened on the chassis base and are without mounting-holes on the motherboard to align with.

2.3 Checking Jumper Settings

For a 2-pin jumper, plug the jumper cap on both pins will make it CLOSE (SHORT). Remove the jumper cap, or plug it on either pin (reserved for future use) will leave it at OPEN position.

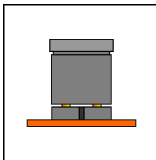

SHORT

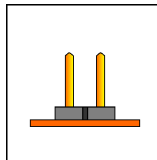

OPEN

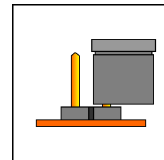

OPEN

For 3-pin jumper, pin 1~2 or pin 2~3 can be shorted by plugging the jumper cap in.

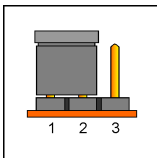

Pin 1~2 SHORT

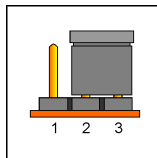

Pin 2~3 SHORT

2.3.1 CMOS Memory Clearing Header and Backup Battery

The time to clear the CMOS memory occurs when (a) the CMOS data becomes corrupted, (b) you forgot the supervisor or user password preset in the BIOS menu, (c) you are unable to boot-up the system because the CPU ratio/clock was incorrectly set in the BIOS menu.

This header uses a jumper cap to clear the CMOS memory and have it reconfigured to the default values stored in BIOS.

- **Pins 2 and 3 shorted (default):** Normal operation.
- **Pins 1 and 2 shorted:** Clear CMOS memory.

To clear the CMOS memory and load in the default values:

1. Power off the system.
2. Set pin 1 and pin 2 shorted by the jumper cap. Wait for a few seconds. Set the jumper cap back to its default settings --- pin 2 and pin 3 shorted.
3. Power on the system.
4. For incorrect CPU ratio/clock settings in the BIOS, press key to enter the BIOS setup menu right after powering on system.
5. Set the CPU operating speed back to its default or an appropriate value.
6. Save and exit the BIOS setup menu.

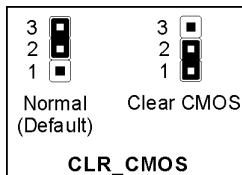
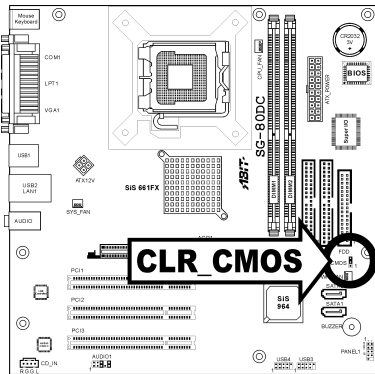

CMOS Backup Battery:

An onboard battery saves the CMOS memory to keep the BIOS information stays on even after disconnected your system with power source. Nevertheless, this backup battery exhausts after some five years. Once the error message like "**CMOS BATTERY HAS FAILED**" or "**CMOS checksum error**" displays on monitor, this backup battery is no longer functional and has to be renewed.

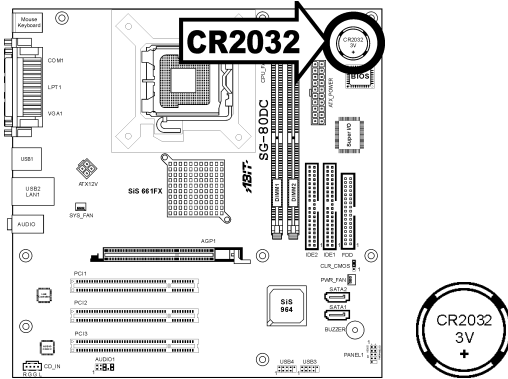

To renew the backup battery:

1. Power off the system and disconnect with AC power source.
2. Remove the exhausted battery.
3. Insert a new CR2032 or equivalent battery. Pay attention to its polarity. The "+" side is its positive polarity.
4. Connect AC power source and power on the system.
5. Enter the BIOS setup menu. Reconfigure the setup parameters if necessary.

CAUTION:

- ⚠ **Danger of explosion may arise if the battery is incorrectly renewed.**
- ⚠ **Renew only with the same or equivalent type recommended by the battery manufacturer.**
- ⚠ **Dispose of used batteries according to the battery manufacturer's instructions.**

2.4 Connecting Chassis Components

2.4.1 ATX Power Connectors

These connectors provide the connection from an ATX power supply. As the plugs from the power supply fit in only one orientation, find the correct one and push firmly down into these connectors.

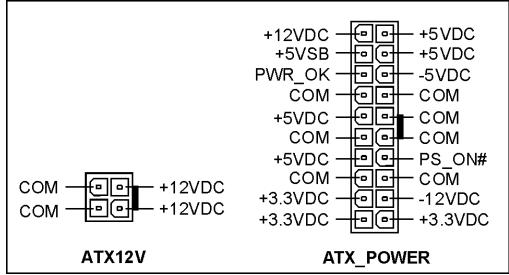
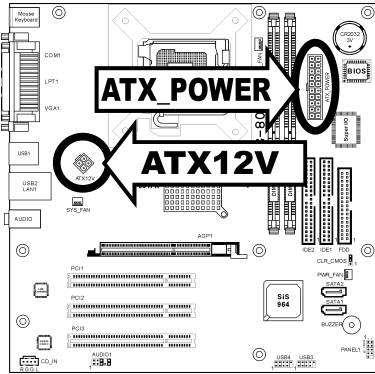

2.4.2 FAN Power Connectors

These connectors each provide power to the cooling fans installed in your system.

- **CPU_FAN:** Power connector for CPU cooling fan
 - **SYS_FAN:** System Fan Power Connector
 - **PWR_FAN:** Auxiliary Fan Power Connector
- ※ These fan connectors are not jumpers. **DO NOT** place jumper caps on these connectors.

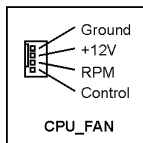
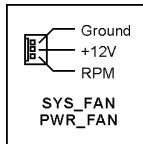
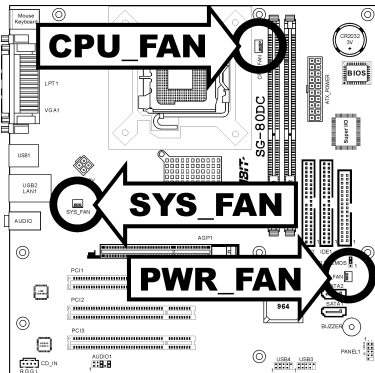

2.4.3 Front Panel Switches & Indicators Headers

This header is used for connecting switches and LED indicators on the chassis front panel.

Watch the power LED pin position and orientation. The mark “+” align to the pin in the figure below stands for positive polarity for the LED connection. Please pay attention to connect these headers. A wrong orientation will only cause the LED not lighting, but a wrong connection of the switches could cause system malfunction.

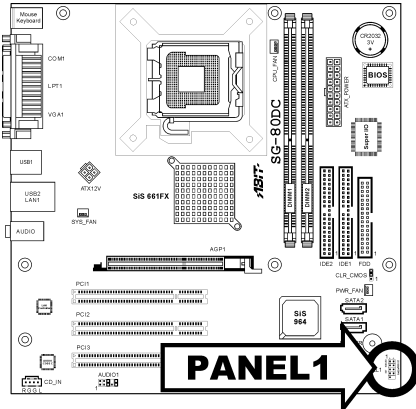

		Pin	Definition	Pin	Definition
1	+	2	+	2	Message LED +
3	-	4	-	4	Message LED -
5		6		6	Power Switch
7		8		8	Power Switch
9					

2.5 Installing Hardware

- ※ **DO NOT** scratch the motherboard when installing hardware. An accidentally scratch of a tiny surface-mount component may seriously damage the motherboard.
- ※ **In order to protect the contact pins, please pay attention to these notices:**
 1. A maximum 20 cycles of CPU installation is recommended.
 2. Never touch the contact pins with fingers or any object.
 3. Always put on the cap when the CPU is not in use.

2.5.1 CPU Socket 775

1. Place the board so as to let the lever-hook of the socket is on your left side. Use your left thumb and forefinger to hold the lever hook, pull it away from the retention tab. Rotate the lever to fully open position.

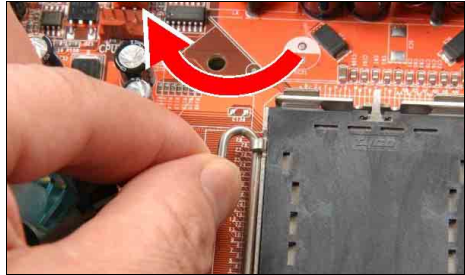

2. Use your right thumb on the bottom-right side of the load plate and lift it up to fully open position.

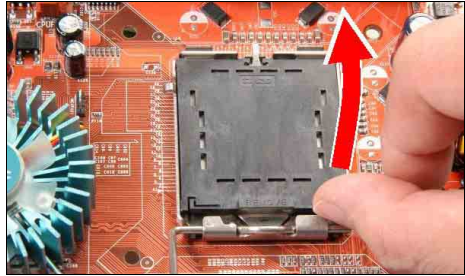

3. Use your right thumb and forefinger to grasp the CPU package. Be sure to grasp on the edge of the substrate, and face the Pin-1 indicator toward the bottom-left side. Aim at the socket and place the CPU package vertical down into the socket.

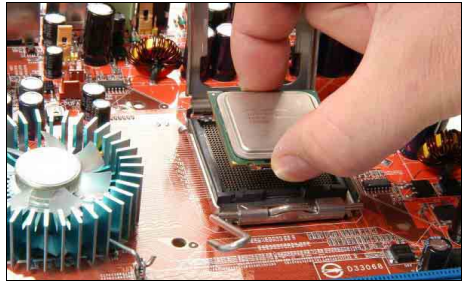

4. Visually inspect if the CPU is seated well into the socket. The alignment key must be located in the notch of package.

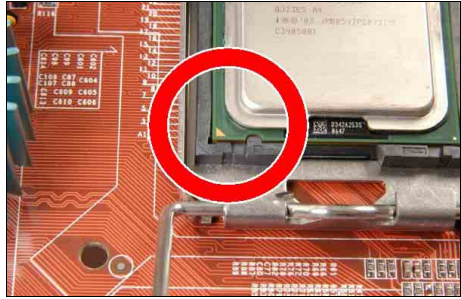

5. Use your left hand to hold the load plate, and use your right thumb to peel the cap off.

※ **The cap plays an important role in protecting contact pins. In order to prevent bent pin, PUT ON the cap after operation or testing.**

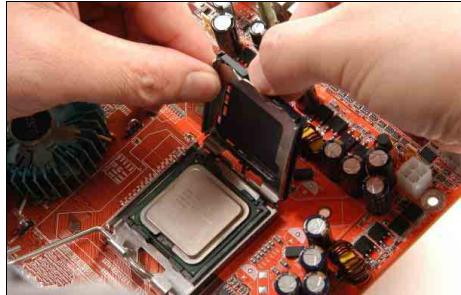

6. Lower the plate onto the CPU package. Engage the load lever while gently pressing down the load plate.



7. Secure the lever with the hook under retention tab.



- Place the heatsink and fan assembly onto the socket. Align the four fasteners toward the four mounting holes on the motherboard.

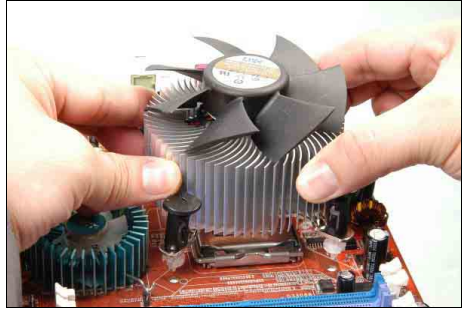

- Press each of the four fasteners down into the mounting holes. Rotate the fastener clock-wise to lock the heatsink and fan assembly into position.

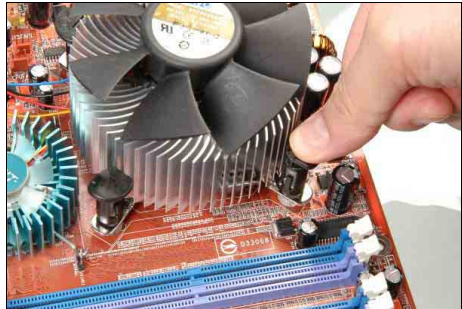

- Attach the four-pin power plug from the heatsink and fan assembly to the CPU FAN connector.

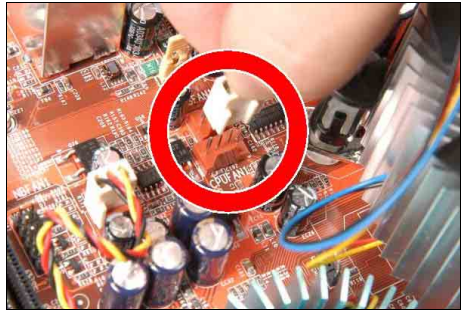

- ※ The installation procedures vary with different types of CPU fan-and-heatsink assembly. The one shown here is served for demo only. For detailed information on how to install the one you bought, refer to its installation guidelines.
- ※ A higher fan speed will be helpful for better airflow and heat-dissipation. Nevertheless, stay alert to touch any heatsink since the high temperature generated by the working system is still possible.

2.5.2 DDR Memory Slots

This motherboard provides two 184-pin DDR DIMM slots for un-buffered and non-ECC modules, memory size expandable up to 2GB (DDR400).

DIMM	DIMM Module	Total Memory
1	256MB, 512MB, 1GB	256MB ~ 1GB
2	256MB, 512MB, 1GB	256MB ~ 1GB
Total System Memory		256MB ~ 2GB

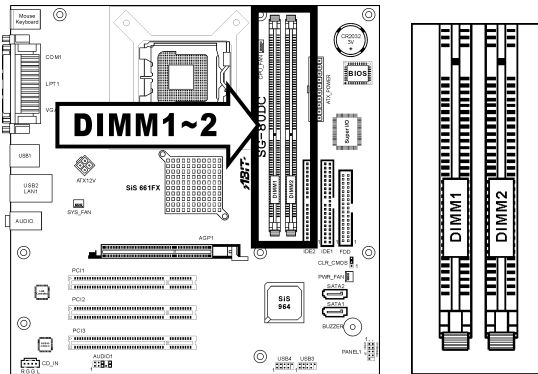

Power off the computer and unplug the AC power cord before installing or removing memory modules.

1. Locate the DIMM slot on the board.
2. Hold two edges of the DIMM module carefully, keep away of touching its connectors.
3. Align the notch key on the module with the rib on the slot.
4. Firmly press the module into the slots until the ejector tabs at both sides of the slot automatically snaps into the mounting notch. Do not force the DIMM module in with extra force as the DIMM module only fit in one direction.
5. To remove the DIMM modules, push the two ejector tabs on the slot outward simultaneously, and then pull out the DIMM module.

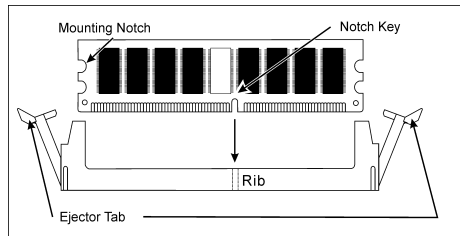

※ **Static electricity can damage the electronic components of the computer or optional boards. Before starting these procedures, ensure that you are discharged of static electricity by touching a grounded metal object briefly.**

2.5.3 Floppy and IDE Disk Drive Connectors

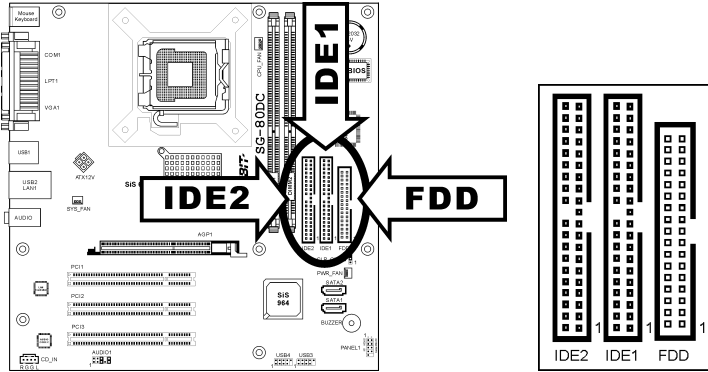

The FDD connector connects up to two floppy drives with a 34-wire, 2-connector floppy cable. Connect the single end at the longer length of ribbon cable to the FDD on the board, the two connectors on the other end to the floppy disk drives connector. Generally you need only one floppy disk drive in your system.

- ✘ **The red line on the ribbon cable must be aligned with pin-1 on both the FDD port and the floppy connector.**

Each of the IDE port connects up to two IDE drives at Ultra ATA/100 mode by one 40-pin, 80-conductor, and 3-connector Ultra ATA/66 ribbon cables.

Connect the single end (blue connector) at the longer length of ribbon cable to the IDE port of this board, the other two ends (gray and black connector) at the shorter length of the ribbon cable to the connectors of your hard drives.

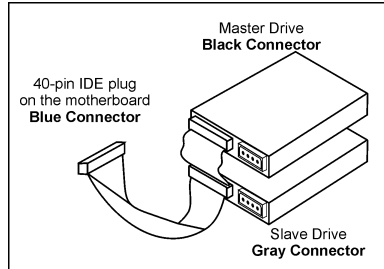

- ✘ **Make sure to configure the "Master" and "Slave" relation before connecting two drives by one single ribbon cable. The red line on the ribbon cable must be aligned with pin-1 on both the IDE port and the hard-drive connector.**

2.5.4 Serial ATA Connectors

Each SATA connector serves as one single channel to connect one SATA device by a thin SATA cable.

The disk array for RAID 0 or RAID 1 configuration is also provided through these SATA connectors.

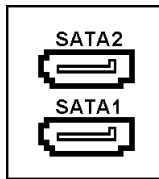
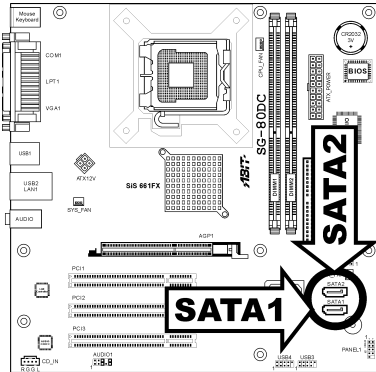

To connect SATA device:

1. Attach either end of the signal cable to the SATA connector on motherboard. Attach the other end to SATA device.
2. Attach the SATA power cable to the SATA device and connect the other end from the power supply.

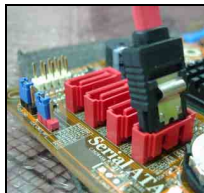

2.5.5 Accelerated Graphics Port Slot

This slot supports an optional AGP graphics card up to AGP 8X/4X mode.

✳ **This motherboard does not support 3.3V AGP cards. Use only 1.5V or 0.8V AGP cards.**

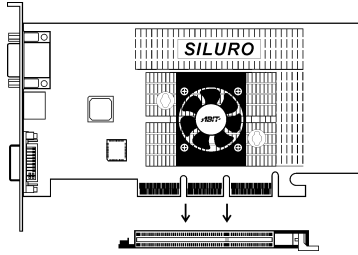
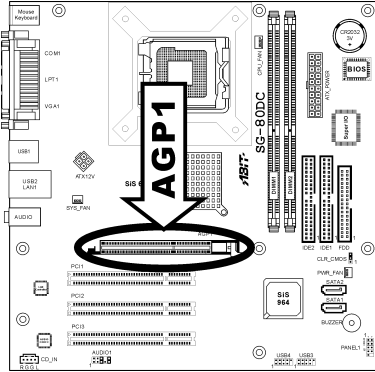

2.5.6 PCI Add-on Slots

These slots provide the connection of add-on cards that comply with PCI specifications.

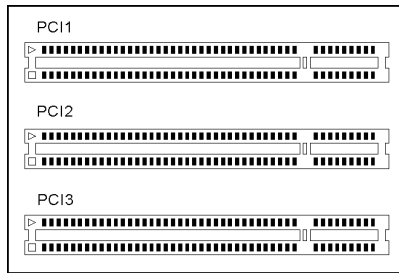
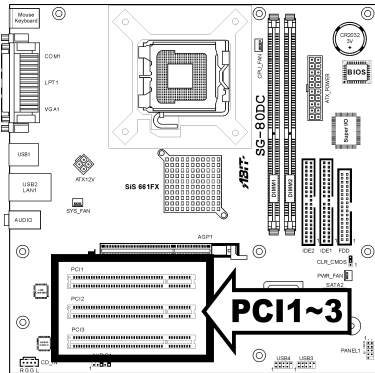

2.6 Connecting Optional Devices

2.6.1 Additional USB 2.0 Port Headers

Besides the 4x USB 2.0 ports located at rear I/O part, this motherboard also features 2x more USB 2.0 headers onboard. Each header supports 2x additional USB 2.0 ports by connecting bracket or cable to the rear I/O panel or the front-mounted USB ports of your chassis.

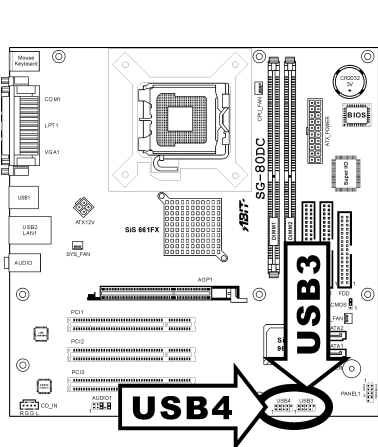

The diagram shows the motherboard layout with two USB headers highlighted: USB3 and USB4. The USB3 header is a 10-pin connector, and the USB4 header is a 10-pin connector. A callout box shows the pin assignments for both headers.

2	4	6	8	10
1	3	5	7	9
USB3/USB4				

Pin	Pin Assignment	Pin	Pin Assignment
1	VCC	2	VCC
3	Data0 -	4	Data1 -
5	Data0 +	6	Data1 +
7	Ground	8	Ground
		10	NC

※ Make sure the connecting cable bears the same pin assignment.

2.6.2 Internal Audio Source Connector

This connector connects to the audio output of internal CD-ROM drive or add-on card.

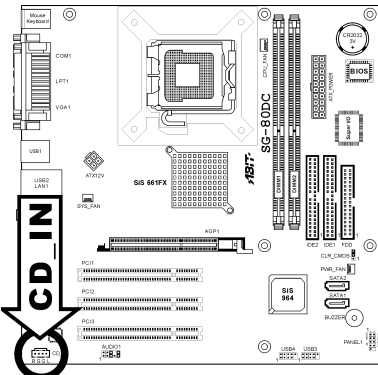

The diagram shows the motherboard layout with the CD_IN header highlighted. A callout box shows the pin assignment for the CD_IN header.

R	G	G	L
CD_IN			

2.6.3 Front Panel Audio Connection Header

This header provides the connection to audio connector at front panel.

- To use the audio connector at front panel, remove all the jumpers on this header, and then connect to front panel by the extension cable provided with the chassis.
- To use the audio connector at rear panel, disconnect the extension cable, attach the jumpers back at pin 5-6, and pin 9-10 (default setting).

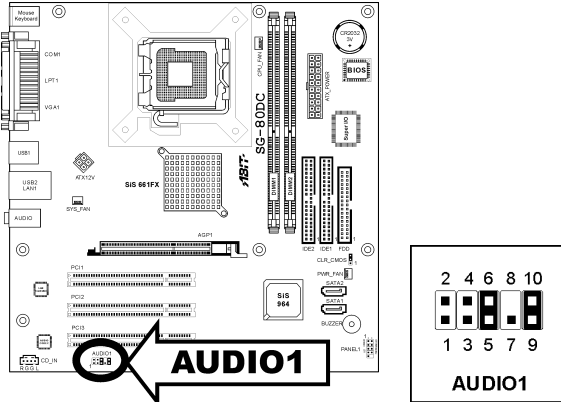

Pin	Signal Name	Function
1	AUD_MIC	Front Panel Microphone input signal
2	AUD_GND	Ground used by Analog Audio Circuits
3	AUD_MIC_BIAS	Microphone Power
4	AUD_VCC Filtered	+5V used by Analog Audio Circuits
5	AUD_F_R	Right Channel audio signal to Front Panel
6	AUD_RET_R	Right Channel Audio signal to Return from Front Panel
7	REVD	Reserved
8	Key	No Pin
9	AUD_F_L	Left Channel Audio signal to Front Panel
10	AUD_RET_L	Left Channel Audio signal to Return from Front Panel

2.7 Connecting I/O Devices

The rear I/O part of this motherboard provides the following I/O ports:

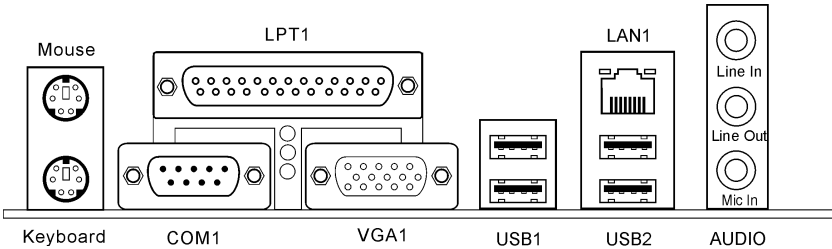

- **Mouse:** PS/2 mouse connector.
- **Keyboard:** PS/2 keyboard connector.
- **LPT1:** Parallel port connector.
- **COM1:** Serial port connector.
- **VGA1:** Monitor signal connector.
- **USB1/USB2:** USB 2.0 connectors.
- **LAN1:** 10/100Mbps LAN connector.
- **AUDIO:**
 - Line In:** Connects to the line out from external audio sources.
 - Line Out:** Connects to the front left and front right channel in the 5.1-channel or regular 2-channel audio system.
 - Mic In:** Connects to the plug from external microphone.

3. BIOS Setup

This motherboard provides a programmable EEPROM that you can update the BIOS utility. The BIOS (Basic Input/Output System) is a program that deals with the basic level of communication between processor and peripherals. Use the BIOS Setup program only when installing motherboard, reconfiguring system, or prompted to "Run Setup". This chapter explains the Setup Utility of BIOS utility.

After powering up the system, the BIOS message appears on the screen, the memory count begins, and then the following message appears on the screen:

PRESS DEL TO ENTER SETUP

If this message disappears before you respond, restart the system by pressing <Ctrl> + <Alt> + keys, or by pressing the Reset button on computer chassis. Only when it failed by these two methods can you restart the system by powering it off and then back on.

After pressing key, the main menu screen appears.

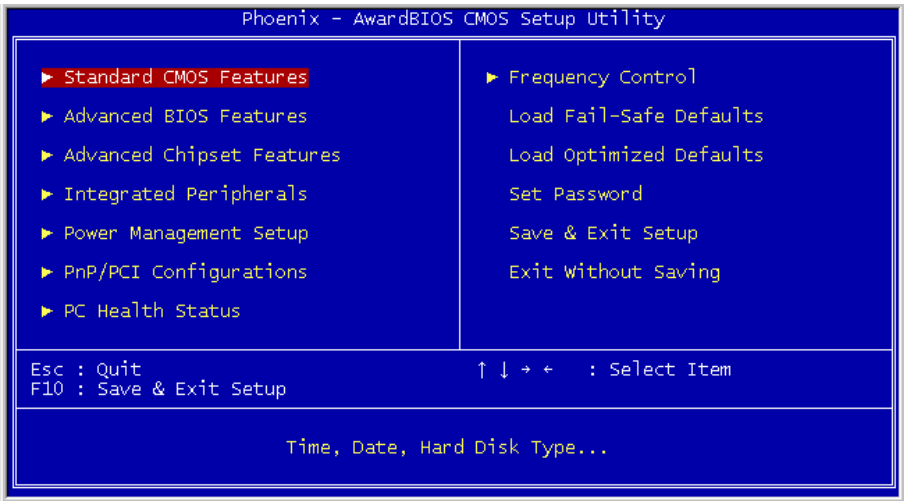



※ In order to increase system stability and performance, our engineering staffs are constantly improving the BIOS menu. The BIOS setup screens and descriptions illustrated in this manual are for your reference only, and may not completely match with what you see on your screen.

4. Driver & Utility

The "Driver & Utility CD" that came packed with this motherboard contains drivers, utilities and software applications required for its basic and advanced features.

Place the "Driver & Utility CD" into the CD-ROM drive in your system. The following installation auto-run screen appears. If not, browse the root directory of the CD-ROM via the File Manager, and double click the "AUTORUN" file.



- **[Drivers]**: Click to enter the driver installation menu.
- **[Manual]**: Click to enter the user's manual menu.
- **[Utility]**: Click to enter the utilities installation menu.
- [ **Browse CD**]: Click to browse the contents of this "Driver & Utility CD".
- [ **Close**]: Click to exit this installation menu.

5. Appendix

5.1 Troubleshooting (How to Get Technical Support?)

5.1.1 Q & A

Q: Do I need to clear the CMOS before I use a new motherboard to assemble my new computer system?

A: Yes, we highly recommend that you clear the CMOS before installing a new motherboard. Please move the CMOS jumper from its default 2-3 position to 1-2 for a few seconds, and then back. When you boot up your system for the first time, follow the instructions in the user's manual to load the optimized defaults.

Q: If my system hangs when I update the BIOS or set the wrong CPU parameters, what should I do?

A: Whenever you update the BIOS or if the system hangs due to wrong CPU parameters setting, always clear CMOS jumper before booting up again.

Q: Why does the system fail to boot up again right after a mechanical power-off?

A: Please keep a 30-second interval between each mechanical power On/Off.

Q: Why does the system fail to boot up and nothing displays on the screen after I did some over-clocking or non-standard settings inside the BIOS?

A: It should not cause hardware or permanent damage to motherboard when BIOS settings were changed from default to over-clocking or non-standard status.

We suggest the following three troubleshooting methods to discharge CMOS data, recover the hardware default status, and then making the motherboard work again. There is no need to bother returning the motherboard to where you bought it from or go through an RMA process.

Step 1. Switch off the power supply unit and then switch it on again after one minute. If there is no power-switch on the power supply unit, disconnect its power cord for one minute and then reconnect.

Press and hold the <Insert> key on the keyboard, and press the power-on button to boot up system. If it works, release the <Insert> key and hit key to enter the BIOS setup page to apply the correct settings.

If the situation remains the same, repeat the procedures in Step 1 for three times, or try Step 2.

Step 2. Switch off the power supply unit or disconnect the power cord. Open the chassis cover. Locate the CMOS jumper near the button battery. Change the jumper position from default 2-3 to 1-2 for one minute to discharge the CMOS data, and then put it back to default 2-3 position.

Close the chassis and switch on the power supply unit or plug in the power cord. Press the power-on button to boot up system. If it works, hit key to enter the BIOS setup page to do the correct settings.

If the situation remains the same, try Step 3.

Step 3. The same procedure as Step 2, but while discharging the CMOS data, pull out the ATX power connectors from motherboard and remove the button battery during CMOS discharge.

Q: How to get a quick response for my request on technical support?

A: Please carry out a simple troubleshooting before sending "Technical Support Form":

System boot-up fails after the system had been assembled:

Check the motherboard's supporting specifications first to see if all the key components attached in your system can meet.

To do so, you may:

↪ Remove all the unnecessary add-on devices (except the CPU, VGA card, DRAM, and Power Supply), and then reboot.

↪ If the trouble still exists, try another VGA card of different brand/model to see if the system will start.

↪ If the trouble still exists, try another memory module of different brand/model.

↪ If the trouble still exists, try another CPU and Power Supply.

If the system runs successfully, shut it down and start re-installing the interface cards and devices that were previously installed in the system. Re-install and start the system one at a time until the system won't start.

Malfunction in the OS:

If the system hangs after resuming from S3 or some testing program, if the CPU cannot be recognized properly, if the display resolution mixed, or if a certain program cannot be executed, etc, you may:

- ↕ Upgrade the motherboard's latest BIOS version.
- ↕ Upgrade the add-on device's latest driver version.
- ↕ Check if there is any conflict in the "Control Panel/System Properties".

Q: How to fill in the "Technical Support Form"?

A: To fill in this "Technical Support Form", please refer to the following instructions:

- **Region:** Type in your country name.
- **E-mail:** Type in your contact E-mail information.
- **First name:** Type in your first name.
- **Last name:** Type in your last name.
- **Subject:** Type in the model name and the problem of your motherboard.
Example 1: AA8XE and SCSI 29160 malfunction
Example 2: AA8XE boot fails, POST code AF
Example 3: AA8XE (system hang when S3 resume)
- **Motherboard:** Type in the model name and revision number of your motherboard.
Example: AA8XE REV: 1.00
- **BIOS Version:** Type in the BIOS version of your motherboard. (You can find it on the screen during the POST sequence.)
- **CPU:** Type in the brand name and the speed (MHz) of your CPU. (Illustrate the over-clocking status if you had done so.)
Example: Intel 650 3.4GHz (OC FSB=220MHz)
- **Memory brand:** Type in the brand and model name of your memory module.
Example: Memory brand: Kingston (KVR533D2N4/1G)
- **Memory size:** Type in the size of your memory module.
Example: 512M* 4PCS
- **Memory configuration:** Type in the memory configuration in BIOS setting.
Example: Memory Timing: 2.5-3-3-7 @533MHz
- **Graphics information:** Note Graphics card's brand, model and driver version
- **Graphics card:** Type in the brand and model name of your graphics card.
Example: ATI RADEON X850 XT PE
- **Graphics driver version:** Type in the driver version of your graphics card
Example: Catalyst 5.12V
- **Power supply maker:** Type in the brand and model name of your power supply unit.
- **Power supply wattage:** Type in the power wattage of your power supply unit.
- **Storage devices:** Type in the brand and specifications of your HDD drive and quantity. Specify if it was inserted on IDE (Master or Slave) or SATA ports, including the RAID allocation status.
Example 1: WD Caviar WD600 60GB (on IDE2 master), Maxtor DiamondMax 10 SATA 300GB (on SATA 3)
Example 2: Maxtor DiamondMax 10 SATA 300GB *2 (on SATA 3, SATA 4 RAID 1)
- **Optical devices:** Type in the brand and specifications of your optical drives and quantity. Specify if it was inserted on IDE (Master or Slave) or SATA ports.
- **Other devices:** Indicate which add-on cards or USB devices that you *absolutely sure* are related to the problem. If you cannot identify the problem's origin, indicate all the add-on cards or USB devices inserted on your system.
Example: AHA 29160 (on PCI 2), Sandisk Cruzer mini 256MB USB Flash-disk.
- **Operating system:** Indicate which OS and language version
Example: Microsoft Windows XP SP2, English version
Example: Microsoft Media Center Edition 2005, Korean version
- **Problem description:** Describe the problem of your system configuration. Indicate the steps to duplicate problem if possible.
See the next page for a blank Technical Support Form, or visit our website to fill in the form on line (<http://www.abit.com.tw/page/en/contact/technical.php>).

Q. Is the motherboard dead? Do I need to return it to where I bought from or go through an RMA process?

A: After you had gone through the troubleshooting procedures, yet the problem still exists, or you find an evident damage on the motherboard. Please contact our RMA center.
(http://www2.abit.com.tw/page/en/contact/index.php?pFUN_KEY=18000&pTITLE_IMG)

5.1.2 Technical Support Form

Country:	
First name:	
Last Name:	
Subject:	
Motherboard:	
BIOS Version:	
CPU:	
Memory brand:	
Memory size:	
Memory configuration:	
Graphics card:	
Graphics driver version:	
Power supply maker:	
Power supply wattage:	
Storage devices:	
Optical devices:	
Other devices:	
Operating system:	
Problem description:	





ABIT Computer Corporation

<http://www.abit.com.tw>