



Your Reliable Partner

# **SG-80 Series**

**(SG-80, SG-81)**

---

***Intel Pentium 4 System Board***

***Socket 775***

***User's Manual***

---

---

### **Copyright and Warranty Notice**

The information in this document is subject to change without notice and does not represent a commitment on part of the vendor, who assumes no liability or responsibility for any errors that may appear in this manual.

No warranty or representation, either expressed or implied, is made with respect to the quality, accuracy or fitness for any particular part of this document. In no event shall the manufacturer be liable for direct, indirect, special, incidental or consequential damages arising from any defect or error in this manual or product.

Product names appearing in this manual are for identification purpose only and trademarks and product names or brand names appearing in this document are property of their respective owners.

This document contains materials protected under International Copyright Laws. All rights reserved. No part of this manual may be reproduced, transmitted or transcribed without the expressed written permission of the manufacturer and authors of this manual.

---

---

# Table of Contents

---

|   |            |
|---|------------|
| <b>Chapter 1. Introduction .....</b>  | <b>1-1</b> |
| 1.1. Features & Specifications.....   | 1-1        |
| 1.2. Layout Diagram (SG-80).....  | 1-3        |
| 1.3. Layout Diagram (SG-81).....  | 1-4        |
| 1.4. Jumpers & Connectors Description.....                                    | 1-5        |
| <br>  |            |
| <b>Chapter 2. Hardware Setup.....</b>   | <b>2-1</b> |
| 2.1. CPU Socket .....   | 2-1        |
| 2.2. System Memory .....  | 2-2        |
| 2.3. Connectors, Headers, and Switches .....                                  | 2-3        |
| 2.3.1. ATX Power Connectors (ATX_POWER, ATX12V)                               | 2-3        |
| 2.3.2. FAN Connectors (CPUFAN, SYSFAN, PWRFAN).                               | 2-4        |
| 2.3.3. CMOS Memory Clearing Header (CCMOS) .....                              | 2-5        |
| 2.3.4. Front Panel Switches & Indicators Connection<br>Headers (PANEL1) ..... | 2-6        |
| 2.3.5. Additional USB Port Connection Header (USB3,<br>USB4) .....            | 2-7        |
| 2.3.6. Front Panel Audio Connection Header<br>(FPIO-AUDIO1).....              | 2-8        |
| 2.3.7. Accelerated Graphics Port Slot (AGP1).....                             | 2-9        |
| 2.3.8. Internal Audio Source Connectors (CD1, AUX1)..                         | 2-10       |
| 2.3.9. Floppy Disk Drive Connector (FDC) .....                                | 2-11       |
| 2.3.10. IDE Disk Drive Connectors (IDE1, IDE2).....                           | 2-12       |
| 2.3.11. Serial ATA connectors (SATA1, SATA2) .....                            | 2-13       |
| 2.3.12. External I/O Panel.....   | 2-14       |
| <br>  |            |
| <b>Chapter 3. BIOS Setup.....</b>   | <b>3-1</b> |
| 3.1. About the Setup Utility.....   | 3-1        |
| 3.1.1. The Standard Configuration .....                                       | 3-1        |
| 3.1.2. Entering the Setup Utility .....                                       | 3-2        |
| 3.1.3. Updating the BIOS .....  | 3-3        |



|         |                                      |      |
|---------|--------------------------------------|------|
| 3.2.    | Using BIOS .....                     | 3-4  |
| 3.2.1.  | Standard CMOS Features .....         | 3-4  |
| 3.2.2.  | Advanced BIOS Features .....         | 3-7  |
| 3.2.3.  | Advanced Chipset Features .....      | 3-10 |
| 3.2.4.  | Integrated Peripherals .....         | 3-14 |
| 3.2.5.  | Power Management Setup .....         | 3-18 |
| 3.2.6.  | PnP/PCI Configurations.....          | 3-20 |
| 3.2.7.  | PC Health Status .....               | 3-22 |
| 3.2.8.  | Frequency Control .....              | 3-23 |
| 3.2.9.  | Load Fail-Safe Defaults Option.....  | 3-23 |
| 3.2.10. | Load Optimized Defaults Option ..... | 3-24 |
| 3.2.11. | Set Password.....                    | 3-24 |
| 3.2.12. | Save & Exit Setup Option.....        | 3-25 |
| 3.2.13. | Exit Without Saving.....             | 3-25 |

**Chapter 4. Driver Installation ..... 4-1**

|      |                   |     |
|------|-------------------|-----|
| 4.1. | Setup Items ..... | 4-2 |
|------|-------------------|-----|

**Appendix A. How to Get Technical Support ..... A-1**

## **Chapter 1. Introduction**

---

### **1.1. Features & Specifications**

#### **CPU**

- Designed for Intel® 90nm Pentium 4/Celeron D LGA775 Processors with 800/533 MHz FSB
- Supports Intel Hyper-Threading Technology

#### **Chipset**

- SIS 661FX/ 964 (L)

#### **Memory**

- Two 184-pin DIMM sockets
- Supports DDR400 non-ECC un-buffered memory
- Supports maximum memory capacity up to 2GB

#### **Graphic**

- Integrated SIS Mirage Graphics GPU high performance 256-bit 3D engine and 2D Accelerator

#### **SATA 150 (Option)**

- Serial ATA 1.5Gbps data transfer rate
- Support SW RAID 0/ 1/ JBOD

#### **LAN**

- Onboard 10/100 PHY

#### **Audio**

- On board 5.1 channels Audio CODEC

#### **Internal I/O Connectors**

- 1x AGP 8X/4X slot. 3x PCI slots
- 1x Floppy Port supports up to 2.88MB
- 2x Ultra DMA 133/100/66/33 Connectors
- 2x Serial ATA 1.5Gbps Connectors (Option)
- 2x USB 2.0 headers (Each header support two USB 2.0 devices)
- 1x FP-Audio header, 1 x CD-IN, 1 x AUX-IN

**Back Panel I/O**

- 1x PS/2 Keyboard, 1x PS/2 Mouse
- 1x Serial Port, 1x Parallel Port, 1x VGA connector
- 4x USB 2.0, 1x RJ-45 LAN Connector
- 1x Audio connectors (Line-out, Line-in, MIC-in)

**Miscellaneous**

- Micro ATX form factor (244mm x 244mm)

**Product List**

| Model | Chipset          | Features          |
|-------|------------------|-------------------|
| SG-80 | SIS 661FX + 964  | 10/100 LAN + SATA |
| SG-81 | SIS 661FX + 964L | 10/100 LAN        |

- \* **All brand names and trademarks are the property of their respective owners.**
- \* **This motherboard is customized for certain system configurations; and may not fit system integration in all DIY ways. Before integrating this product, please check ABIT web site for recommended device listings, or contact sales/tech. support people.**
- \* **Specifications and information contained herein are subject to change without notice.**

## 1.2. Layout Diagram (SG-80)

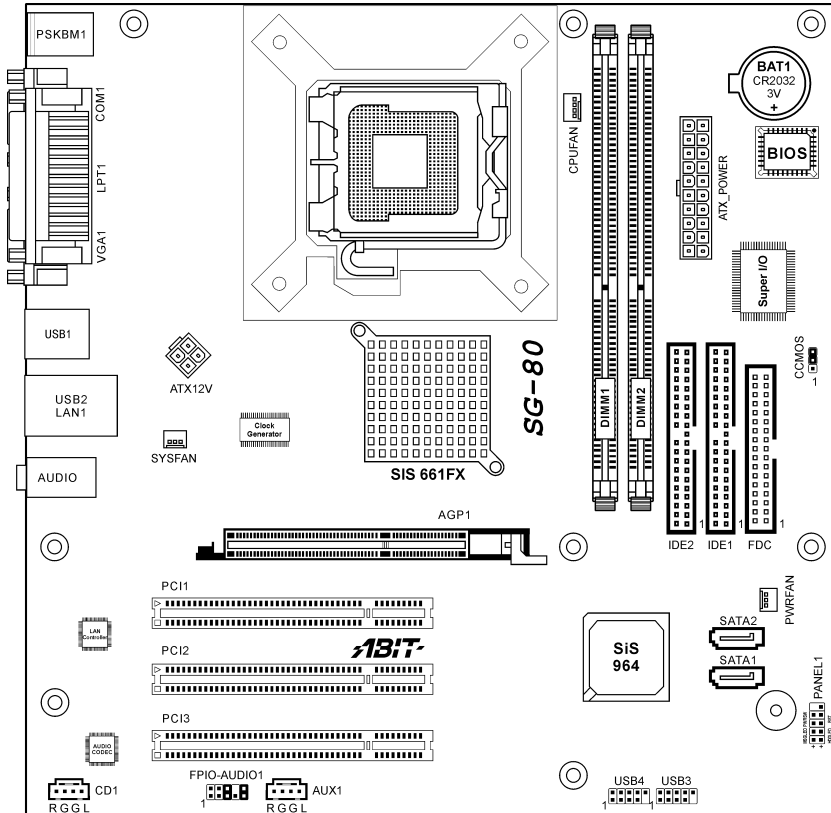

### 1.3. Layout Diagram (SG-81)

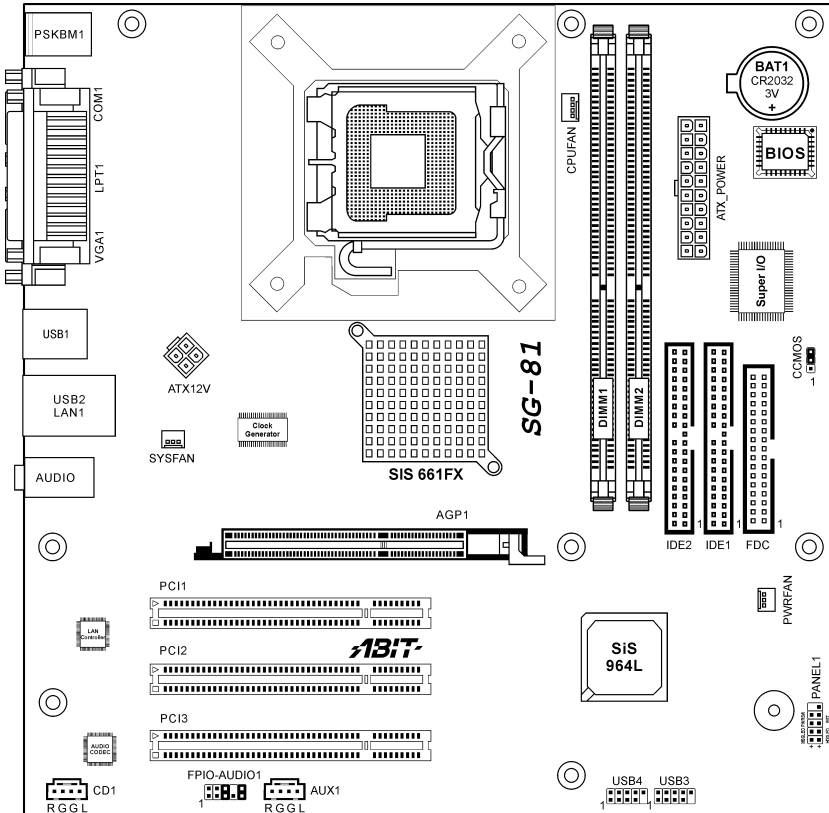



## 1.4. Jumpers & Connectors Description

| <b>Jumpers</b> | <b>Description</b>          | <b>Default Setting</b>   |
|----------------|-----------------------------|--------------------------|
| CCMOS          | CMOS Memory Clearing Header | Pins 2-3 Closed (Normal) |

| <b>Connectors</b>       | <b>Description</b>   |
|-------------------------|--|
| AGP1                    | Accelerated Graphics Port Slot                               |
| ATX_POWER<br>ATX12V     | ATX Power Connectors   |
| CD1/AUX1                | Internal Audio Connectors                                    |
| CPUFAN<br>SYSFAN/PWRFAN | CPU Fan Power Connector<br>System/Power Fan Power Connectors |
| DIMM1/DIMM2             | DDR DIMM Slots   |
| FDC1                    | Floppy Disk Drive Connector                                  |
| FPIO_AUDIO1             | Front Panel Audio Connection Header                          |
| IDE1/IDE2               | Hard Disk Drive Connectors                                   |
| PANEL1                  | Front Panel Switch Connection Headers                        |
| PCI1/PCI2/PCI3          | 32bit/33MHz PCI Slots  |
| SATA1/SATA2             | Serial ATA connectors  |
| USB3/USB4               | Additional USB Port Connection Headers                       |



## Chapter 2. Hardware Setup

### 2.1. CPU Socket

This server board provides one 775-pin Zero Insertion Force (ZIF) socket to install the Intel Pentium 4 CPU.

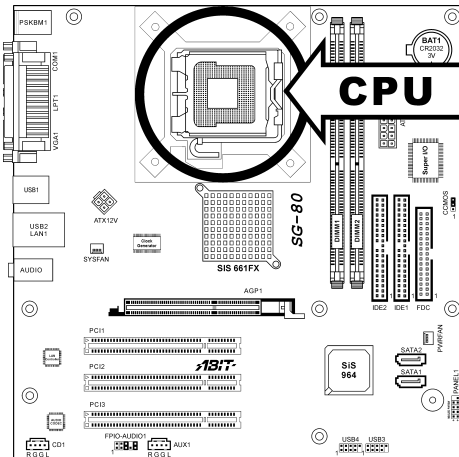

## 2.2. System Memory

This system board provides two 184-pin DDR DIMM slots for un-buffered and non-ECC modules with memory size expandable up to 2GB (DDR400).

| DIMM                       | DIMM Module       | Total Memory |
|----------------------------|-------------------|--------------|
| 1                          | 256MB, 512MB, 1GB | 256MB ~ 1GB  |
| 2                          | 256MB, 512MB, 1GB | 256MB ~ 1GB  |
| <b>Total System Memory</b> |                   | 256MB ~ 2GB  |

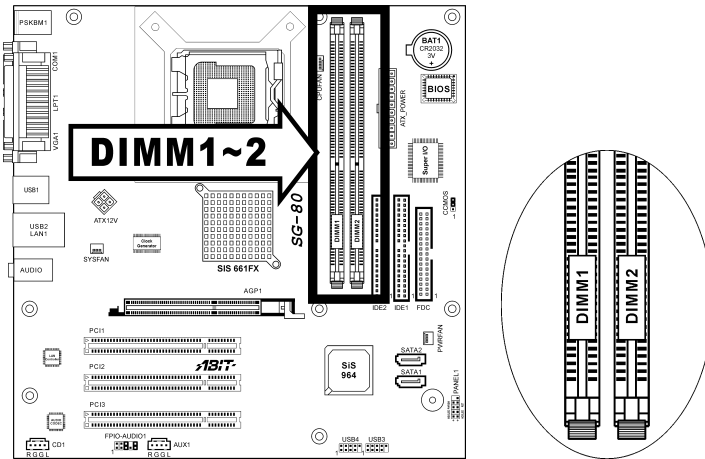

### 2.3. Connectors, Headers, and Switches

All the connectors, headers and switches mentioned here are depending on your system configuration. Some features you may (or may not) have to connect or to configure depending on the peripherals you have connected.

**WARNING:** Always power off the computer and unplug the AC power cord before adding or removing any peripheral or component. Failing to do so may cause severe damage to your system board and/or peripherals. Plug in the AC power cord only after you have carefully checked everything.

#### 2.3.1. ATX Power Connectors (ATX\_POWER, ATX12V)

This connector provides the connection to ATX12V power supply.

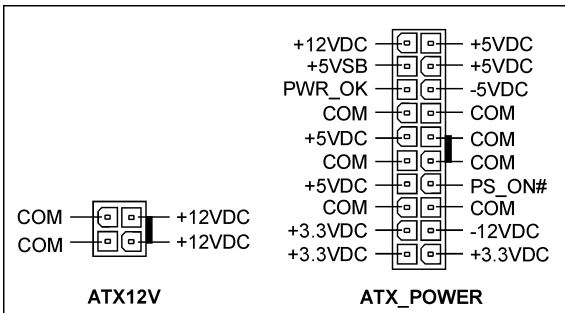
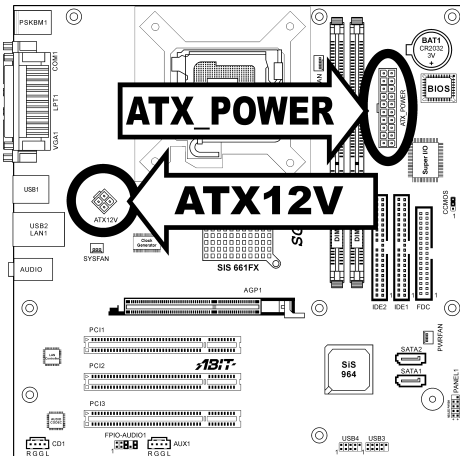

### 2.3.2. FAN Connectors (CPUFAN, SYSFAN, PWFAN)

These connectors each provide power to the cooling fans installed in your system.

- **CPUFAN:** Power connector for CPU cooling fan
- **SYSFAN, PWFAN:** Power connector for System and Power Fan

**WARNING:** These fan connectors are not jumpers. DO NOT place jumper caps on these connectors.

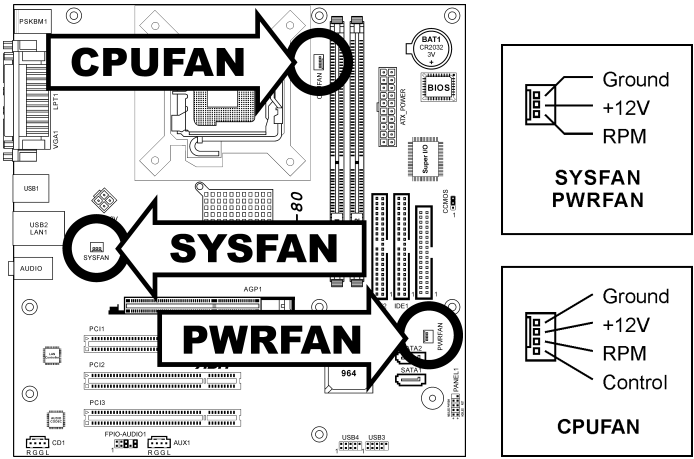

### 2.3.3. CMOS Memory Clearing Header (CCMOS)

This header uses a jumper cap to clear the CMOS memory.

- **Pin 2-3 shorted (default):** Normal operation.
- **Pin 1-2 shorted:** Clear CMOS memory.

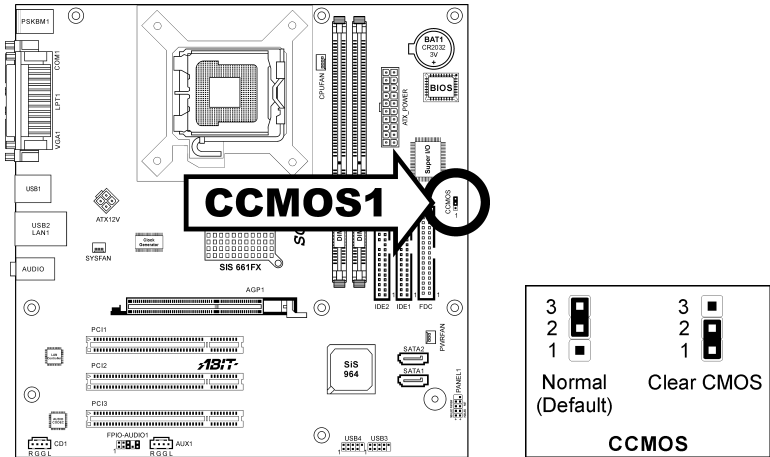

**ATTENTION:** Turn the system power off first (including the +5V standby power) before clearing the CMOS memory. Failing to do so may cause your system to work abnormally or malfunction.

### 2.3.4. Front Panel Switches & Indicators Connection Headers (PANEL1)

These headers are used for connecting switches and LED indicators on the chassis front panel. The mark “+” align to the pin in the figure below stands for positive polarity for the LED connection.

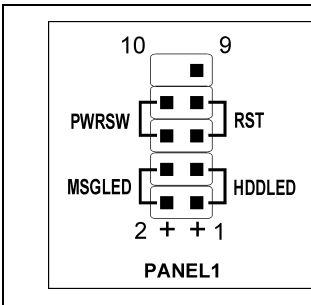
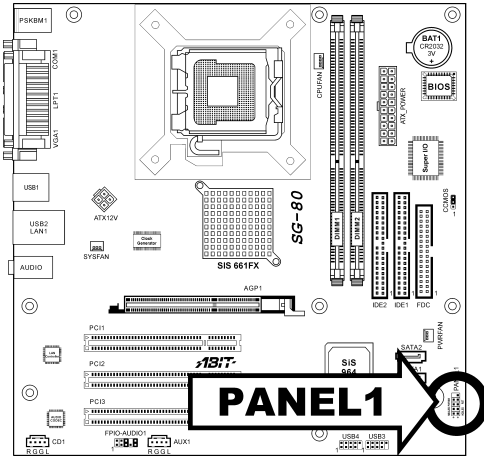

| Pin | Definition | Pin | Definition    |
|-----|------------|-----|---------------|
| 1   | HD LED +   | 2   | Message LED + |
| 3   | HD LED -   | 4   | Message LED - |
| 5   | RESET      | 6   | Power Switch  |
| 7   | RESET      | 8   | Power Switch  |
| 9   | Reserved   | 10  | NC            |



### 2.3.5. Additional USB Port Connection Header (USB3, USB4)

These headers each provide 2 additional USB 2.0 ports connection through an USB cable designed for USB 2.0 specifications.

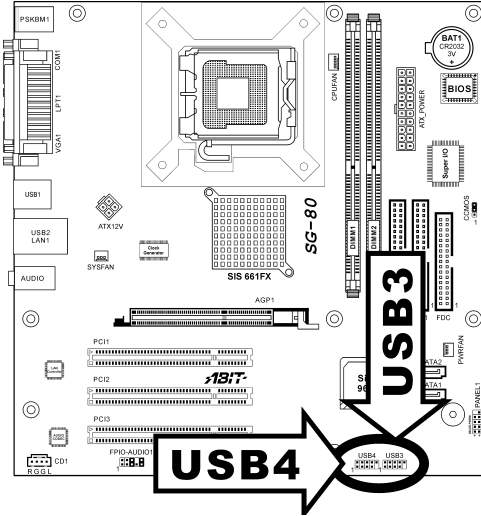

|                                    | Pin | Signal Name | Function                   |
|------------------------------------|-----|-------------|----------------------------|
| <p><b>USB3</b><br/><b>USB4</b></p> | 1   | USBPWR      | Front Panel USB Power      |
|                                    | 2   | USBPWR      | Front Panel USB Power      |
|                                    | 3   | USB_FP_P0-  | USB Port 0 Negative Signal |
|                                    | 4   | USB_FP_P1-  | USB Port 1 Negative Signal |
|                                    | 5   | USB_FP_P0+  | USB Port 0 Positive Signal |
|                                    | 6   | USB_FP_P1+  | USB Port 1 Positive Signal |
|                                    | 7   | GND         | Ground                     |
|                                    | 8   | GND         | Ground                     |
|                                    | 9   | Key         | No pin                     |
|                                    | 10  | NC          | NC                         |

### 2.3.6. Front Panel Audio Connection Header (FPIO-AUDIO1)

This header provides the connection to audio connector at front panel.

- To use the audio connector at front panel, remove all the jumpers on this header, and then connect to front panel by the extension cable provided with the chassis.
- To use the audio connector at rear panel, disconnect the extension cable, attach the jumpers back at pin 5-6, and pin 9-10 (default setting).

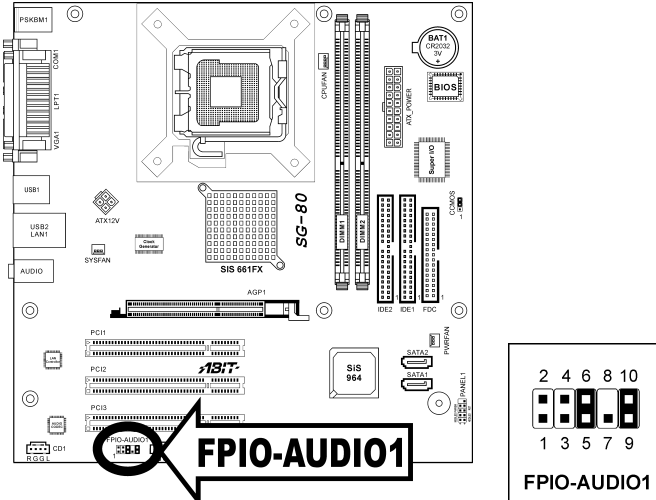

| Pin | Signal Name      | Function  |
|-----|------------------|---|
| 1   | AUD_MIC          | Front Panel Microphone input signal                   |
| 2   | AUD_GND          | Ground used by Analog Audio Circuits                  |
| 3   | AUD_MIC_BIAS     | Microphone Power                                      |
| 4   | AUD_VCC Filtered | +5V used by Analog Audio Circuits                     |
| 5   | AUD_F_R          | Right Channel audio signal to Front Panel             |
| 6   | AUD_RET_R        | Right Channel Audio signal to Return from Front Panel |
| 7   | REVD             | Reserved  |
| 8   | Key              | No Pin  |
| 9   | AUD_F_L          | Left Channel Audio signal to Front Panel              |
| 10  | AUD_RET_L        | Left Channel Audio signal to Return from Front Panel  |



### 2.3.8. Internal Audio Source Connectors (CD1, AUX1)

These connectors connect to the audio output of internal CD-ROM drive or add-on card.

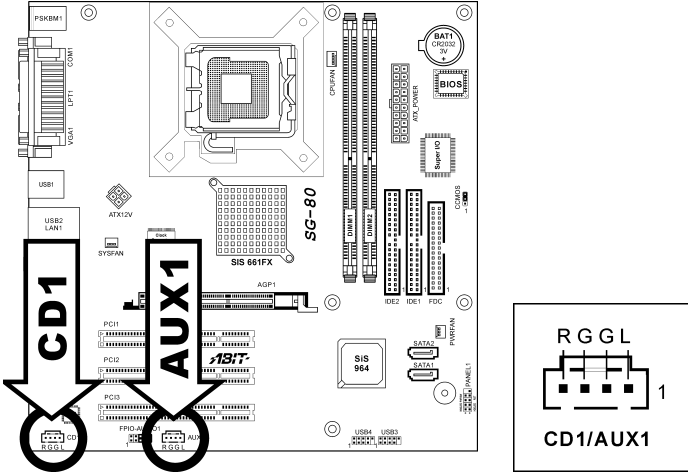

### 2.3.9. Floppy Disk Drive Connector (FDC)

This connector supports two standard floppy disk drives via a 34-pin 34-conductor ribbon cable.

Connecting the Floppy Disk Drive Cable:

1. Install one end of the ribbon cable into the FDC connector. The colored edge of the ribbon cable should be aligned with pin-1 of FDC connector.
2. Install the other end(s) of ribbon cable into the disk drive connector(s). The colored edge of the ribbon cable should be also aligned with pin-1 of disk drive connector. The endmost connector should be attached to the drive designated as Drive A.

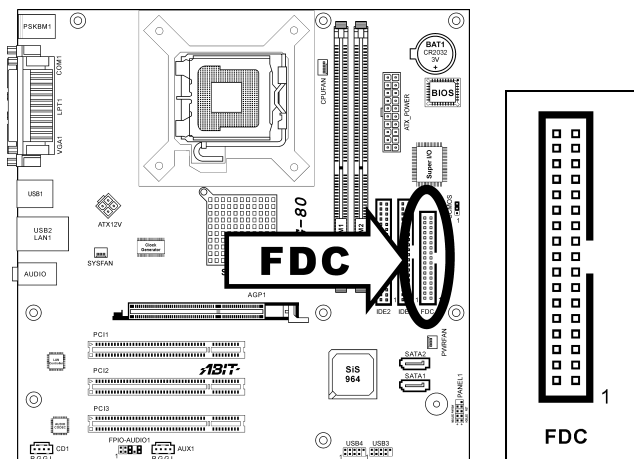

### 2.3.10. IDE Disk Drive Connectors (IDE1, IDE2)

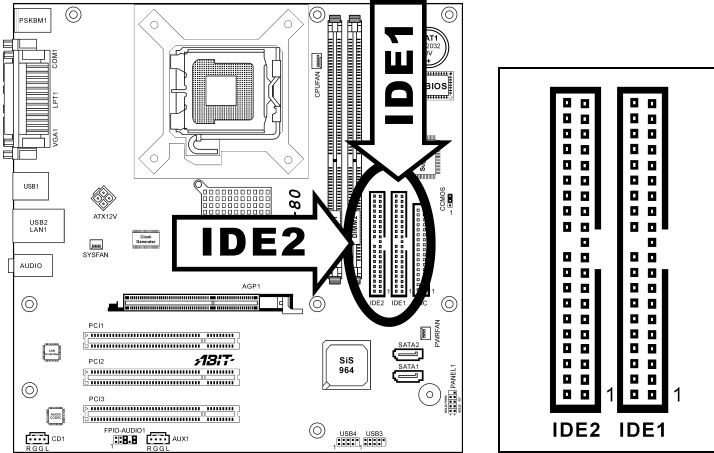

These IDE ports each connects up to two IDE drives at Ultra ATA/100 mode by one 40-pin, 80-conductor, and 3-connector Ultra ATA/66 ribbon cables. Connect the single end (blue connector) at the longer length of ribbon cable to the IDE port on system board, and the other two ends (gray and black connector) at the shorter length of the ribbon cable to the connectors on hard drives.

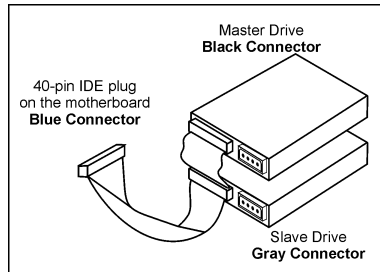

**NOTE:** The red line on the ribbon cable should be aligned with pin-1 on this connector.

### 2.3.11. Serial ATA connectors (SATA1, SATA2)

These connectors are provided to attach one Serial ATA device at each channel via Serial ATA cable.

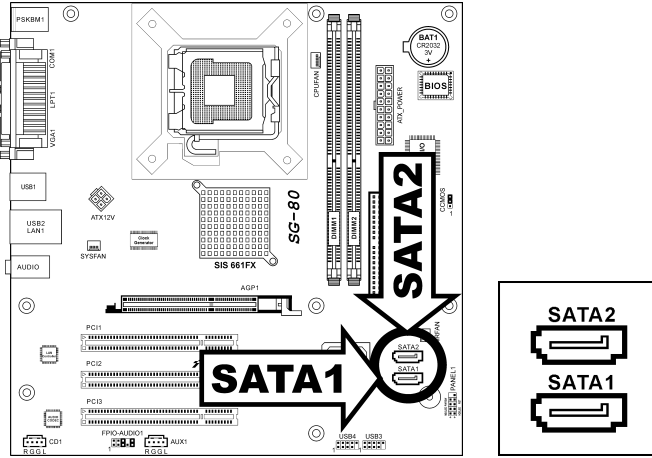

### 2.3.12. External I/O Panel

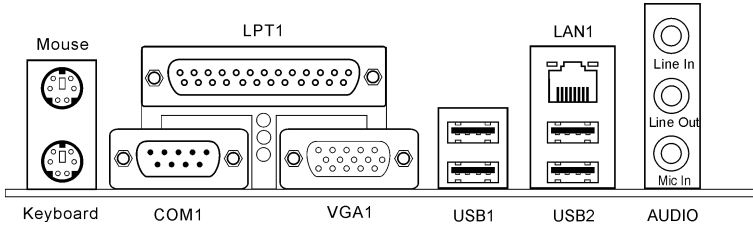

- **Mouse:** PS/2 mouse connector.
- **Keyboard:** PS/2 keyboard connector.
- **LPT1:** Parallel port connector.
- **COM1:** Serial port connector.
- **VGA1:** Monitor signal connector.
- **USB1/USB2:** USB 2.0 connectors.
- **LAN1:** 10/100Mbps LAN connectors.
- **AUDIO:**
  - Mic In:** Connects to the plug from external microphone.
  - Line In:** Connects to the line out from external audio sources.
  - Line Out:** Connects to the front left and front right channel in the 5.1-channel or regular 2-channel audio system.



## **Chapter 3. BIOS Setup**

---

### **3.1. About the Setup Utility**

The computer uses the latest Award BIOS with support for Windows Plug and Play. The CMOS chip on the motherboard contains the ROM setup instructions for configuring the motherboard BIOS.

The BIOS (Basic Input and Output System) Setup Utility displays the system's configuration status and provides you with options to set system parameters. The parameters are stored in battery-backed-up CMOS RAM that saves this information when the power is turned off. When the system is turned back on, the system is configured with the values you stored in CMOS.

*The BIOS Setup Utility enables you to configure:*

- Hard drives, diskette drives and peripherals
- Video display type and display options
- Password protection from unauthorized use
- Power Management features

The settings made in the Setup Utility affect how the computer performs. Before using the Setup Utility, ensure that you understand the Setup Utility options.

This chapter provides explanations for Setup Utility options.

#### **3.1.1. The Standard Configuration**

A standard configuration has already been set in the Setup Utility. However, we recommend that you read this chapter in case you need to make any changes in the future.

*This Setup Utility should be used:*

- when changing the system configuration
- when a configuration error is detected and you are prompted to make changes to the Setup Utility
- when trying to resolve IRQ conflicts
- when making changes to the Power Management configuration
- when changing the password or making other changes to the Security Setup

### 3.1.2. Entering the Setup Utility

When you power on the system, BIOS enters the Power-On Self Test (POST) routines. POST is a series of built-in diagnostics performed by the BIOS. After the POST routines are completed, the following message appears:

**Press <DEL> to enter *SETUP***

Pressing the <Delete> key accesses the BIOS Setup Utility:

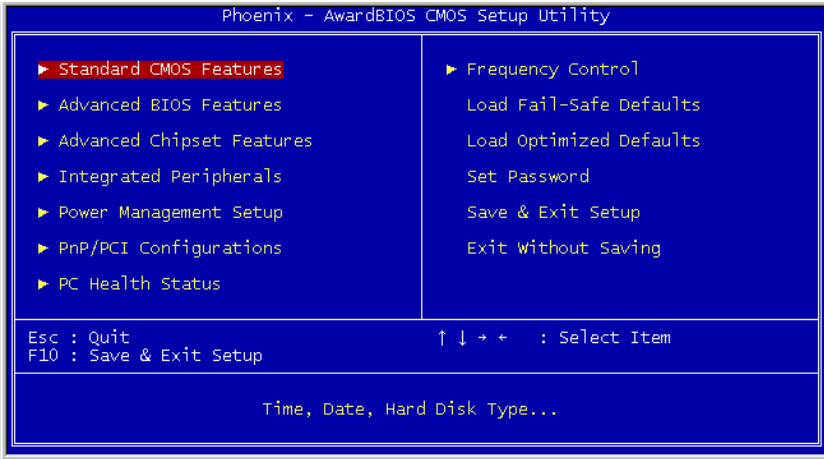

#### **BIOS Navigation Keys**

The BIOS navigation keys are listed below:

| KEY              | FUNCTION  |
|------------------|---|
| <b>ESC</b>       | Exits the current menu                              |
| ←↑↓→             | Scrolls through the items on a menu                 |
| <b>+/-/PU/PD</b> | Modifies the selected field's values                |
| <b>F10</b>       | Saves the current configuration and exits setup     |
| <b>F1</b>        | Displays a screen that describes all key functions  |
| <b>F5</b>        | Loads previously saved values to CMOS               |
| <b>F6</b>        | Loads a minimum configuration for troubleshooting   |
| <b>F7</b>        | Loads an optimum set of values for peak performance |

### **3.1.3. Updating the BIOS**

You can download and install updated BIOS for this motherboard from the manufacturer's Web site. New BIOS provides support for new peripherals, improvements in performance, or fixes for known bugs.

***Install new BIOS as follows:***

1. If your motherboard has a BIOS protection jumper, change the setting to allow BIOS flashing.
2. If your motherboard has an item called Firmware Write Protect in Advanced BIOS features, disable it. (Firmware Write Protect prevents BIOS from being overwritten.)
3. Create a bootable system disk. (Refer to Windows online help for information on creating a bootable system disk.)
4. Download the Flash Utility and new BIOS file from the manufacturer's Web site. Copy these files to the system diskette you created in Step 3.
5. Turn off your computer and insert the system diskette in your computer's diskette drive. (You might need to run the Setup Utility and change the boot priority items on the Advanced BIOS Features Setup page, to force your computer to boot from the floppy diskette drive first.)
6. At the A:\ prompt, type the Flash Utility program name and press <Enter>.
7. Type the filename of the new BIOS in the "File Name to Program" text box. Follow the onscreen directions to update the motherboard BIOS.
8. When the installation is complete, remove the floppy diskette from the diskette drive and restart your computer. If your motherboard has a Flash BIOS jumper, reset the jumper to protect the newly installed BIOS from being overwritten.

## 3.2. Using BIOS

When you start the Setup Utility, the main menu appears. The main menu of the Setup Utility displays a list of the options that are available. A highlight indicates which option is currently selected. Use the cursor arrow keys to move the highlight to other options. When an option is highlighted, execute the option by pressing <Enter>.

Some options lead to pop-up dialog boxes that prompt you to verify that you wish to execute that option. Other options lead to dialog boxes that prompt you for information.

Some options (marked with a triangle ►) lead to submenus that enable you to change the values for the option. Use the cursor arrow keys to scroll through the items in the submenu.

In this manual, default values are enclosed in parenthesis. Submenu items are denoted by a triangle ►.

### 3.2.1. Standard CMOS Features

This option displays basic information about your system.

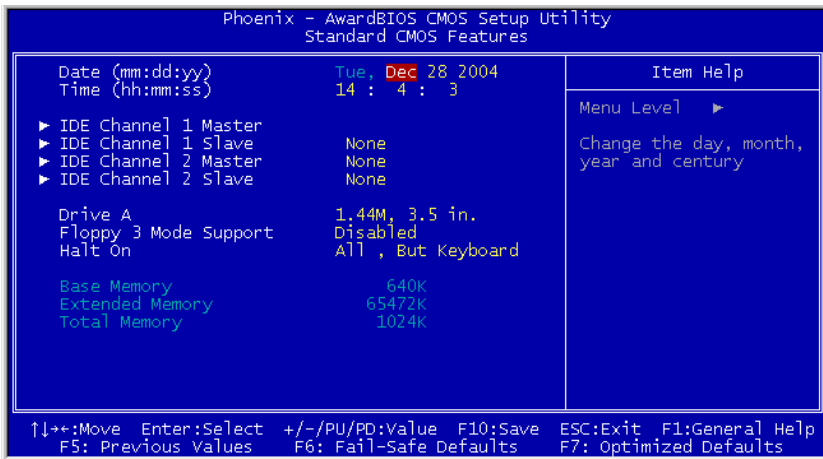

### Date and Time

The Date and Time items show the current date and time on the computer. If you are running a Windows OS, these items are automatically updated whenever you make changes to the Windows Date and Time Properties utility.

**IDE Devices (None)**

Your computer has two IDE channels (Primary and Secondary) and each channel can be installed with one or two devices (Master and Slave). Use these items to configure each device on the IDE channel.

This motherboard features two SATA connectors supporting two SATA drives. SATA refers to Serial ATA (Advanced Technology Attachment), the standard interface for the IDE hard drives which are currently used in most PCs.

*Press <Enter> to display the IDE submenu:*

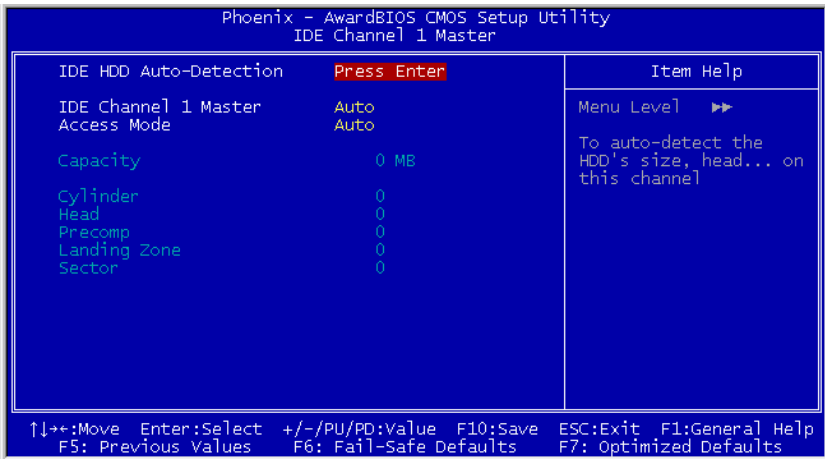

**IDE HDD Auto-Detection**

Press <Enter> while this item is highlighted to prompt the Setup Utility to automatically detect and configure an IDE device on the IDE channel.

**NOTE:** If you are setting up a new hard disk drive that supports LBA mode, more than one line will appear in the parameter box. Choose the line that lists LBA for an LBA drive.

**IDE Channel 1/2 Master/Slave/ IDE Drive(Auto)**

Leave this item at Auto to enable the system to automatically detect and configure IDE devices on the channel. If it fails to find a device, change the value to Manual and then manually configure the drive by entering the characteristics of the drive in the items described below.

Refer to your drive's documentation or look on the drive casing if you need to obtain this information. If no device is installed, change the value to None.

**NOTE:** Before attempting to configure a hard disk drive, ensure that you have the configuration information supplied by the manufacturer of your hard drive. Incorrect settings can result in your system not recognizing the installed hard disk.

---

### **Access Mode (Auto)**

This item defines ways that can be used to access IDE hard disks such as LBA (Large Block Addressing). Leave this value at Auto and the system will automatically decide the fastest way to access the hard disk drive.

*Press <Esc> to return to the Standard CMOS Features page.*

---

### **Drive A/Drive B (1.44M, 3.5 in./None)**

These items define the characteristics of any diskette drive attached to the system. You can connect one or two diskette drives.

---

### **Floppy 3 Mode Support (Disabled)**

Floppy 3 Mode refers to a 3.5-inch diskette with a capacity of 1.2 MB. Floppy 3 Mode is sometimes used in Japan.

---

### **Video (EGA/VGA)**

This item defines the video mode of the system. This motherboard has a built-in VGA graphics system; you must leave this item at the default value.

---

### **Halt On (All, But Keyboard)**

This item defines the operation of the system POST (Power On Self Test) routine. You can use this item to select which types of errors in the POST are sufficient to halt the system.

---

### **Base Memory, Extended Memory, and Total Memory**

These items are automatically detected by the system at start up time. These are display-only fields. You cannot make changes to these fields.

---

### 3.2.2. Advanced BIOS Features

This option defines advanced information about your system.

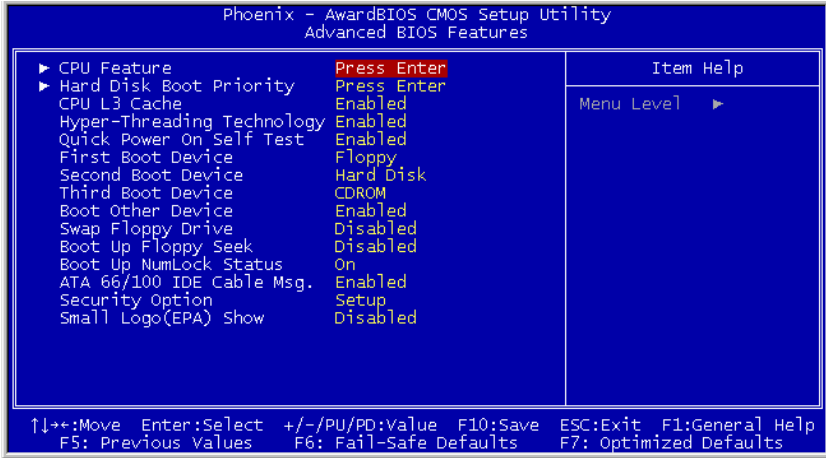

#### ☞ CPU Feature

Scroll to this item and press <Enter> to view the following screen:

Users please note that this function is only available for Prescott CPUs.

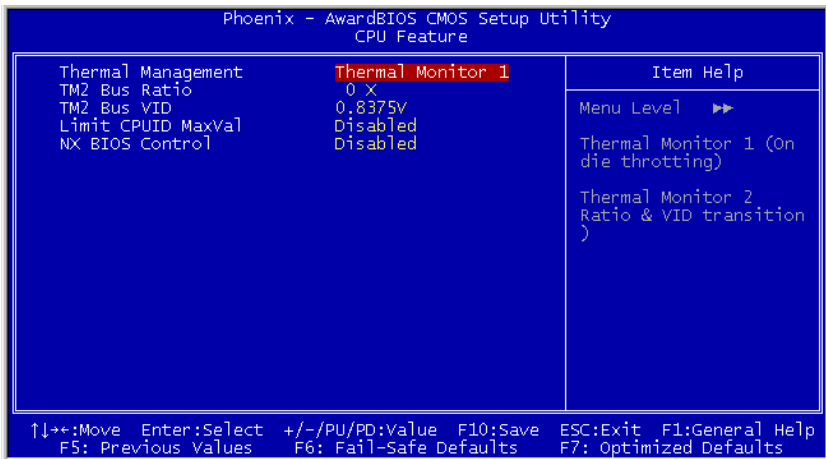

---

### **Thermal Management**

This item displays CPU's temperature and enables you to set a safe temperature to Prescott CPU.

---

### **TM2 Bus Ratio**

This item represents the frequency (bus ratio) of the throttled performance state that will be initiated when the on-die sensor goes from not hot to hot).

---

### **TM2 Bus VID**

This item represents the voltage of the throttled performance state that will be initiated when the on-die sensor goes from not hot to hot.

---

### **Limit CPUID MaxVal**

This item can support Prescott CPUs for old OS. Users please note that under NT 4.0, it must be set "Enabled", while under WinXP, it must be set "Disabled".

---

### **NX BIOS Control**

When disabled, forces the NX feature flag to always return to 0.

### **↵ Hard Disk Boot Priority**

Scroll to this item and press <Enter> to view the following screen:

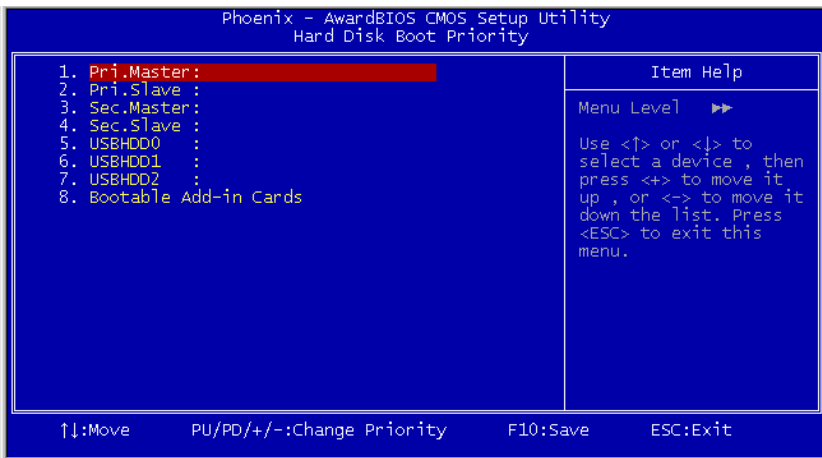



**CPU L3 Cache (Enabled)**

This item is only available when processors support L3. Some high-end processors support L3. If the CPU do support L3, you may set this item to enable or disable. Leave this item at the default value for better performance.

---

**Hyper-Threading Technology (Enabled)**

This item is only available when the chipset supports Hyper-Threading and you are using a Hyper-Threading CPU.

---

**Quick Power On Self Test (Enabled)**

Enable this item to shorten the power on testing (POST) and have your system start up faster. You might like to enable this item after you are confident that your system hardware is operating smoothly.

---

**First/Second/Third Boot Device (Floppy/Hard Disk/CDROM)**

Use these three items to select the priority and order of the devices that your system searches for an operating system at start-up time.

---

**Boot Other Device (Enabled)**

When enabled, the system searches all other possible locations for an operating system if it fails to find one in the devices specified under the First, Second, and Third boot devices.

---

**Swap Floppy Drive [Disabled]**

If you have two floppy diskette drives in your system, this item allows you to swap the assigned drive letters so that drive A becomes drive B, and drive B becomes drive A.

---

**Boot Up Floppy Seek (Disabled)**

If this item is enabled, it checks the size of the floppy disk drives at start-up time. You don't need to enable this item unless you have a legacy diskette drive with 360K capacity.

---

**Boot Up NumLock Status (On)**

This item defines if the keyboard Num Lock key is active when your system is started.

---

---

**ATA 66/100 IDE Cable Msg. (Enabled)**

This item enables or disables the display of the ATA 66/100 Cable MSG.

**Security Option (Setup)**

If you have installed password protection, this item defines if the password is required at system start up, or if it is only required when a user tries to enter the Setup Utility.

**Small Logo(EPA) Show**

This item determines to show the EPA logo when booting.

**3.2.3. Advanced Chipset Features**

These items define critical timing parameters of the motherboard. You should leave the items on this page at their default values unless you are very familiar with the technical specifications of your system hardware. If you change the values incorrectly, you may introduce fatal errors or recurring instability into your system.

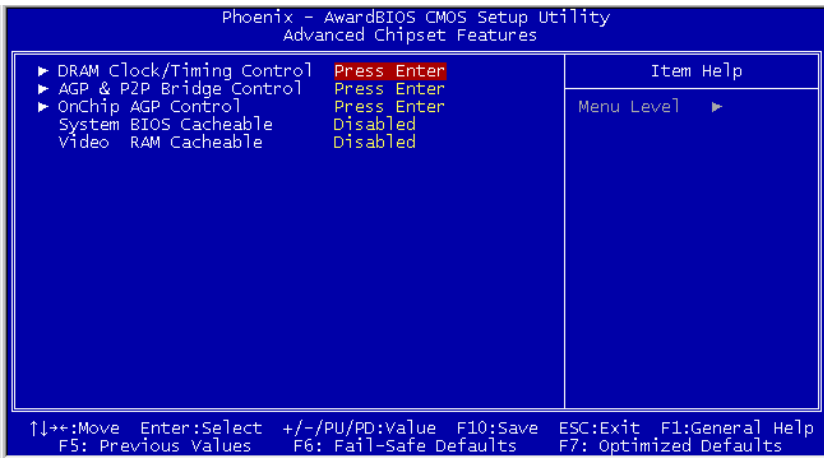

↩ **DRAM Clock/Timing Control:**

Scroll to this item and press <Enter> to view the following screen:

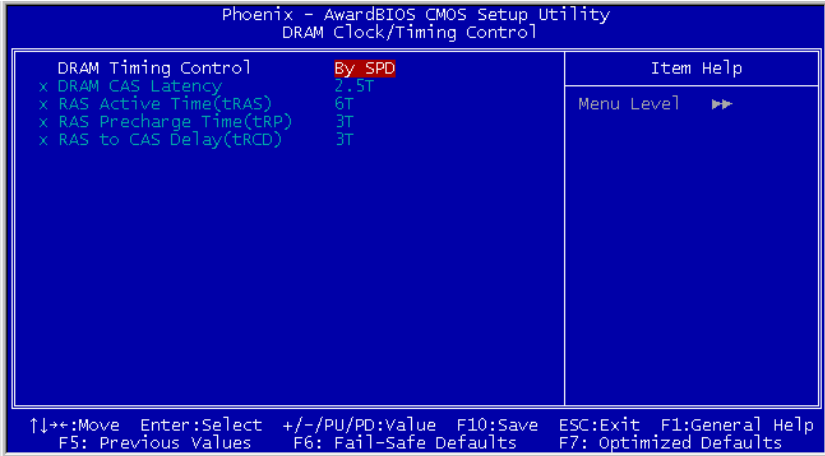

**DRAM Timing Control**

Enables you to select the CAS latency time in HCLKs of 2, 2.5, or 3. The value is set at the factory depending on the DRAM installed. Do not change the values in this field unless you change specifications of the installed DRAM or the installed CPU.

✱ **DRAM CAS Latency:**

This item controls the timing delay (in clock cycles) before the DRAM starts a read command after receiving it.

✱ **RAS Active Time (tRAS):**

This item allows you to set the amount of time a RAS can be kept open for multiple accesses. High figures will improve performance.

✱ **RAS Precharge Time (tRP):**

This is the duration of the time interval during which the Row Address Strobe signal to a DRAM is held low during normal Read and Write Cycles. This is the minimum interval between completing one read or write and starting another from the same (non-page mode) DRAM. Techniques such as memory interleaving, or use of Page Mode DRAM are often used to avoid this delay. Some chipsets require this parameter in order to set up the memory configuration properly. The RAS Precharge value is typically about the same as the RAM Access (data read/write) time.

\* **RAS to CAS Delay (tRCD):**

This is the amount of time a CAS is performed after a RAS. The lower the better, but some DRAM does not support low figures.

*Press <Esc> to return to the Advanced Chipset Features page.*

↩ **AGP & P2P Bridge Control**

Scroll to this item and press <Enter> to view the following screen:

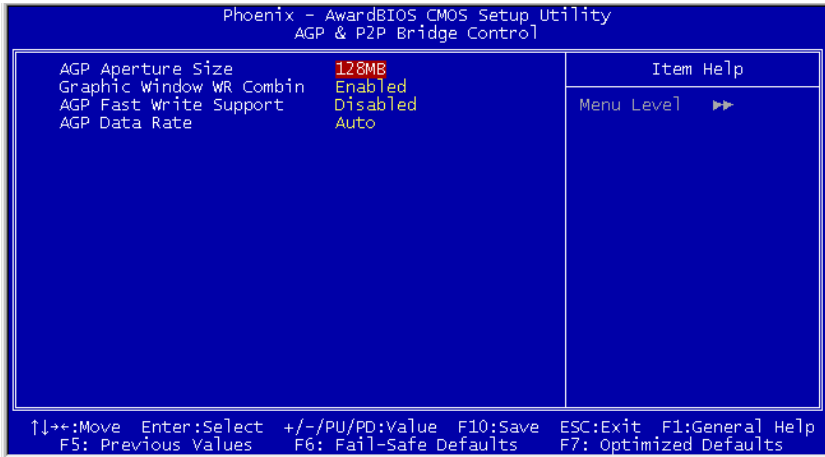

**AGP Aperture Size**

This setting controls just how much system RAM can be allocated to AGP for video purposes. The aperture is a portion of the PCI memory address range dedicated to graphics memory address space. Host cycles that hit the aperture range are forwarded to the AGP without any translation.

**Graphic Window WR Combin (Enabled)**

Use this item to enable or disable CPU support for WR Combin feature.

**AGP Fast Write Support (Disabled)**

This item lets you enable or disable the caching of display data for the video memory of the processor.

---

**AGP Data Rate (Auto)**

This item allows users to set the AGP Data Rate by, Auto, 1X, 2X, 4X, or 8X, depending on what speed the AGP card supports.

*Press <Esc> to return to the Advanced Chipset Features page.*

**↵ OnChip AGP Control**

Scroll to this item and press <Enter> to view the following screen:

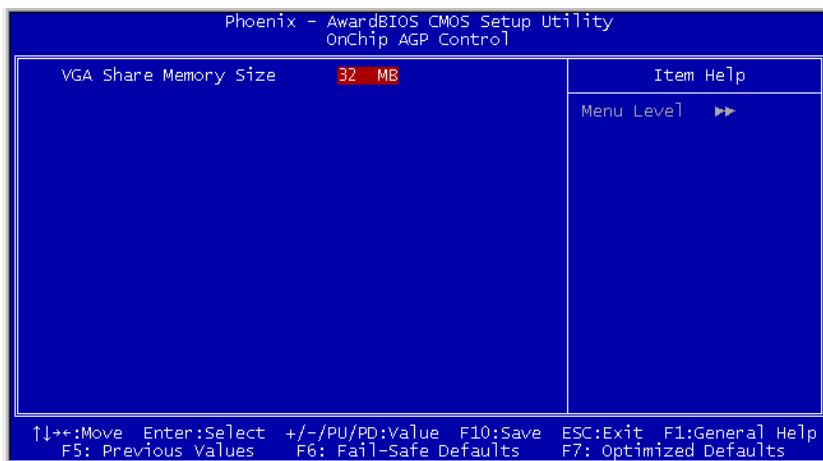

---

**VGA Share Memory Size (32M)**

This item allows you to select the shared memory size for VGA usage.

*Press <Esc> to return to the Advanced Chipset Features screen.*

---

**System BIOS Cacheable (Disabled)**

This feature is only valid when the system BIOS is shadowed. It enables or disables the caching of the system BIOS ROM at **F0000h-FFFFFh** via the L2 cache. This greatly speeds up accesses to the system BIOS.

---

**Video RAM Cacheable (Disabled)**

This feature enables or disables the caching of the video RAM at **A0000h-AFFFFh** via the L2 cache.

### 3.2.4. Integrated Peripherals

These options display items that define the operation of peripheral components on the system's input/output ports.

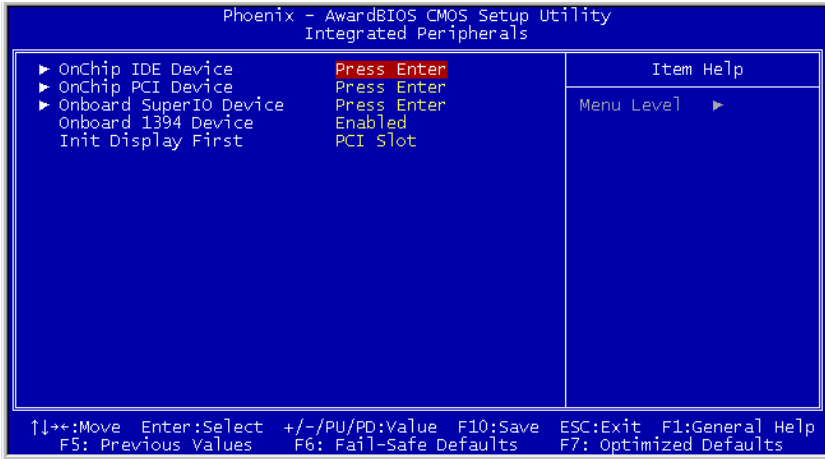

#### ↩ OnChip IDE Device

Scroll to this item and press <Enter> to view the following screen:

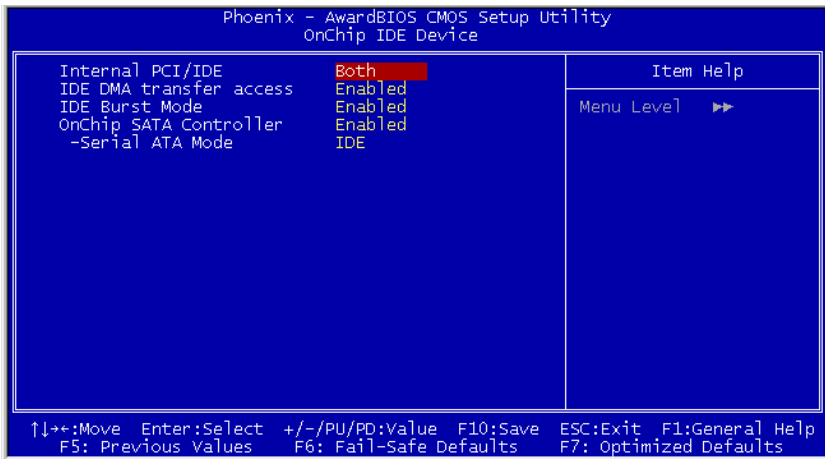

---

**Internal PCI/IDE (Both)**

Use these items to enable or disable the internal PCI IDE channels that are integrated on the mainboard.

---

**IDE DMA Transfer Access (Enabled)**

This item allows you to enabled the transfer access of the IDE DMA.

---

**IDE Burst Mode (Enabled)**

This option, when enabled will instruct the system to send every write transaction to the write buffer. Burstable transactions then burst onto the PCI bus and nonburstable transactions do not.

---

**OnChip SATA Controller (Enabled)**

Enables or disables the onboard Serial ATA controller. Enable this item if you are to install SATA devices onboard.

✧ **Serial ATA Mode (IDE)**

Use this item to define the onboard SATA mode. Set this item to RAID if you are to activate the RAID function of the SATA devices.

*Press <Esc> to return to the Integrated Peripherals screen.*

## ☞ OnChip PCI Device

Scroll to this item and press <Enter> to view the following screen:

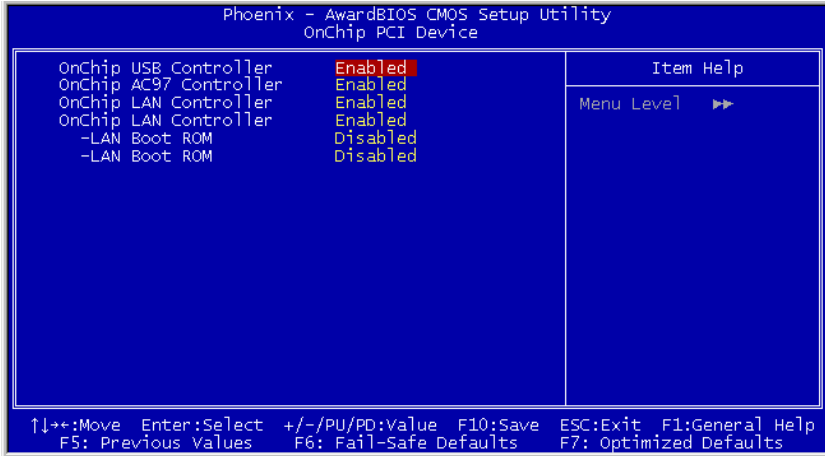

### **OnChip USB Controller (Enabled)**

Enable this item if you plan to use the Universal Serial Bus ports on this mainboard.

### **OnChip AC97 Controller (Enabled)**

Enables or disables the onboard AC97 audio function. Disable this item if you are going to install a PCI audio add-on card.

### **OnChip LAN Controller (Enabled)**

Enables and disables the onboard LAN chip.

### **LAN Boot ROM (Disabled)**

Use this item to enable and disable the booting from the onboard LAN or a network add-in card with a remote boot ROM installed.



Press <Esc> to return to the *Integrated Peripherals* screen.

↵ **Onboard SuperIO Device:**

Scroll to this item and press <Enter> to view the following screen:

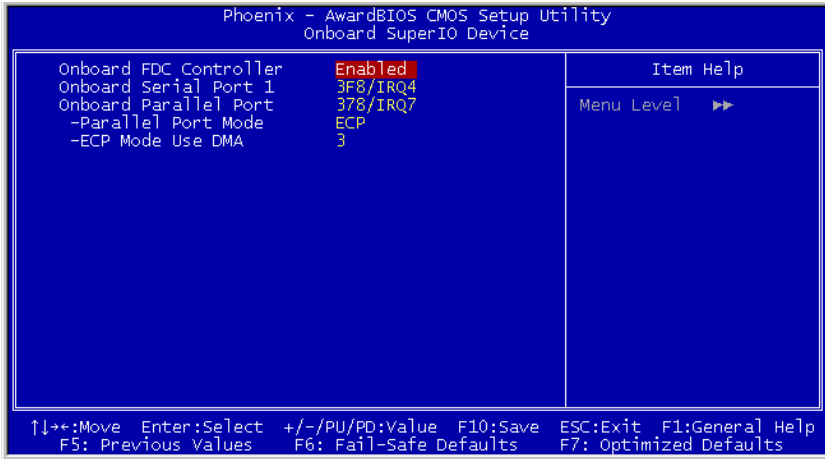

---

**Onboard FDC Controller (Enabled)**

This option enables the onboard floppy disk drive controller.

---

**Onboard Serial Port 1 (3F8/IRQ4)**

This option is used to assign the I/O address and interrupt request (IRQ) for onboard serial port1 (COM1).

---

**Onboard Parallel Port (378/IRQ7)**

This option is used to assign the I/O address and interrupt request (IRQ) for the onboard parallel port.

✱ **Parallel Port Mode (ECP)**

Enables you to set the data transfer protocol for your parallel port. There are four options: SPP (Standard Parallel Port), EPP (Enhanced Parallel Port), ECP (Extended Capabilities Port), and ECP+EPP.

SPP allows data output only. Extended Capabilities Port (ECP) and Enhanced Parallel Port (EPP) are bi-directional modes, allowing both data input and output. ECP and EPP modes are only supported with EPP- and ECP-aware peripherals.

### \* ECP Mode Use DMA (3)

When the onboard parallel port is set to ECP mode, the parallel port can use DMA3 or DMA1.

*Press <Esc> to return to the Integrated Peripherals screen.*

### **Onboard 1394 Device (Enabled)**

Enables and disables the onboard IEEE 1394 controller.

### **Init Display First (PCI Slot)**

Use this item to specify whether your graphics adapter is installed in one of the PCI slots or is integrated on the motherboard.

## 3.2.5. Power Management Setup

This option lets you control system power management. The system has various power-saving modes including powering down the hard disk, turning off the video, suspending to RAM, and software power down that allows the system to be automatically resumed by certain events.

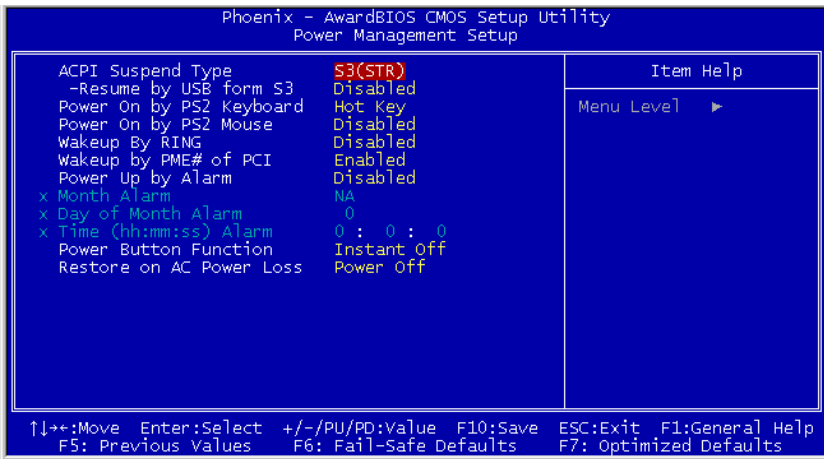

### **ACPI Suspend Type (S3(STR))**

Use this item to define how your system suspends. In the default, S1(POS), the suspend mode is equivalent to a software power down. If you select S3 (STR), the suspend mode is a suspend to RAM, i.e., the system shuts down with the exception of a refresh current to the system memory.

**\* Resume by USB from S3 (Disabled)**

When set to Enabled, the system power will resume the system from a power saving mode if there is any USB port activity.

---

**Power On by PS2 Keyboard (Hot Key)**

This option enables you to allow the keyboard activity to awaken the system from power saving mode.

---

**Power On by PS2 Mouse (Disabled)**

This option enables you to allow the mouse activity to awaken the system from power saving mode.

---

**WakeUp By Ring (Disabled)**

Use this item to enable LAN or modem activity to wakeup the system from a power saving mode.

---

**WakeUp By PME# of PCI (Enabled)**

This item allows users to enable or disable PCI activity to wakeup the system from a power saving mode.

---

**Power Up by Alarm (Disabled)**

When set to Enabled, the following three fields become available: Month Alarm, Day of Month Alarm, and Time Alarm Upon arrival of the alarm time, it will instruct the system to wake up.

When set to 0 (zero) for the day of the month, the alarm will power on your system every day at the specified time.

---

**Power Button Override:**

Under ACPI (Advanced Configuration and Power management Interface) you can create a software power down. In a software power down, the system can be resumed by Wake Up Alarms. This item lets you install a software power down that is controlled by the power button on your system. If the item is set to Instant-Off, then the power button causes a software power down. If the item is set to Delay 4 Sec. then you have to hold the power button down for four seconds to cause a software power down.

---

**Restore On AC Power Loss:**

This item selects the system action after an AC power failure.

---

---

**[Power Off]:** When power returns after an AC power failure, the system's power remains off. You must press the Power button to power-on the system.

**[Power On]:** When power returns after an AC power failure, the system's power will be powered on automatically.

**[Last State]:** When power returns after an AC power failure, the system will return to the state where you left off before power failure occurs. If the system's power is off when AC power failure occurs, it will remain off when power returns. If the system's power is on when AC power failure occurs, the system will power-on when power returns.

### 3.2.6. PnP/PCI Configurations

These options configure how PnP (Plug and Play) and PCI expansion cards operate in your system. Both the ISA and PCI buses on the motherboard use system IRQs (Interrupt ReQuests) and DMAs (Direct Memory Access). You must set up the IRQ and DMA assignments correctly through the PnP/PCI Configurations Setup utility for the motherboard to work properly. Selecting PnP/PCI Configurations on the main program screen displays this menu:

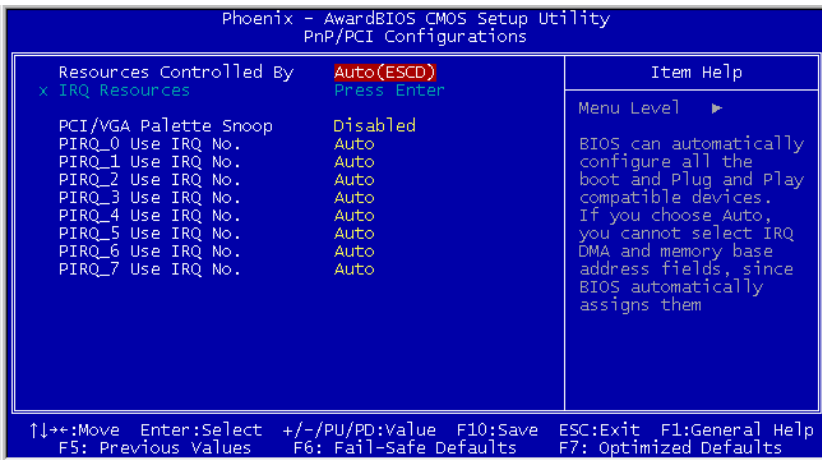

#### **Resources Controlled By (Auto(ESCD))**

You should leave this item at the default Auto(ESCD). Under this setting, the system dynamically allocates resources to Plug and Play devices as they are required.

If you cannot get a legacy ISA (Industry Standard Architecture) expansion card to work properly, you might be able to solve the problem by changing this item to Manual, and then opening up the IRQ Resources submenu.

In the IRQ Resources submenu, if you assign an IRQ to Legacy ISA, then that Interrupt Request Line is reserved for a legacy ISA expansion card. Press <Esc> to close the IRQ Resources submenu.

### ☞ **IRQ Resources**

The submenu allows you to individually assign an interrupt type for interrupts IRQ-3 to IRQ-15.

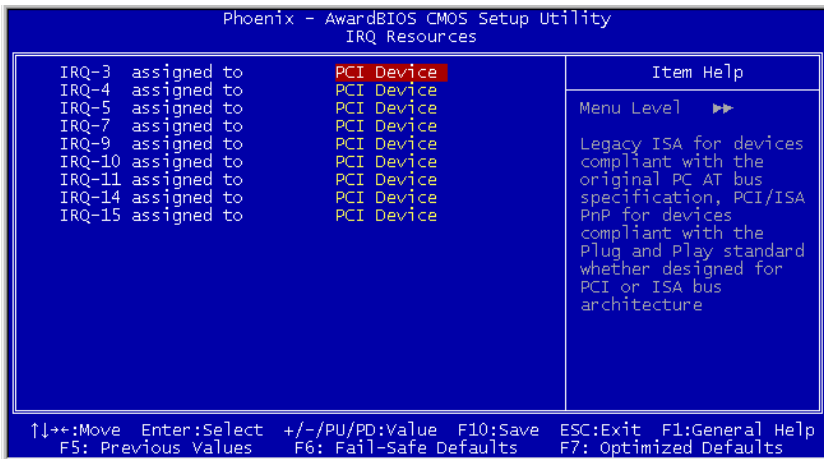

In the IRQ Resources submenu, if you assign an IRQ to Legacy ISA, then that Interrupt Request Line is reserved for a legacy ISA expansion card. Press <Esc> to close the IRQ Resources submenu.

In the Memory Resources submenu, use the first item Reserved Memory Base to set the start address of the memory you want to reserve for the ISA expansion card. Use the section item Reserved Memory Length to set the amount of reserved memory. Press <Esc> to close the Memory Resources submenu.

---

### **PCI/VGA Palette Snoop [Disabled]**

This item is designed to overcome problems that can be caused by some non-standard VGA cards. This board includes a built-in VGA system that does not require palette snooping so you must leave this item disabled.

**PIRQ 0 Use IRQ No. ~ PIRQ 7 Use IRQ No. [Auto]**

This item specifies the IRQ number manually or automatically for the devices installed on PCI slots.

**3.2.7. PC Health Status**

On motherboards that support hardware monitoring, this item lets you monitor the parameters for critical voltages, critical temperatures, and fan speeds.

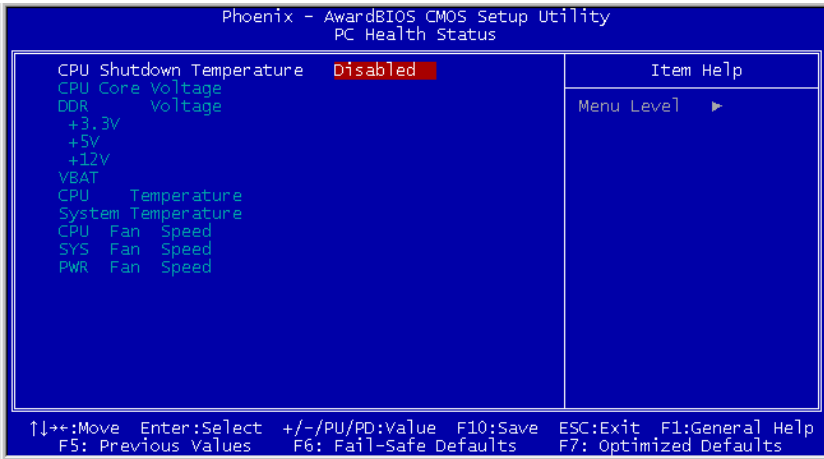
**CPU Shutdown Temperature (Disabled)**

This item sets the temperature that would shutdown the system automatically in order to prevent system overheats.

**NOTE:** This item only works for the OS with ACPI activated.

**System Component Characteristics**

These items allow end users and technicians to monitor data provided by the BIOS on this motherboard. You cannot make changes to these fields.

### 3.2.8. Frequency Control

This item enables you to set the clock speed and system bus for your system. The clock speed and system bus are determined by the kind of processor you have installed in your system.

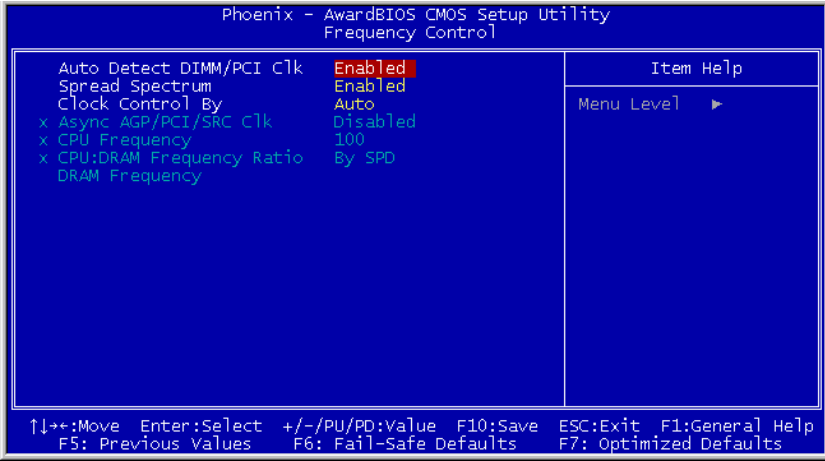

#### Auto Detect DIMM/PCI Clk (Enabled)

When this item is enabled, BIOS will disable the clock signal of free DIMM/PCI slots.

#### Spread Spectrum (Enabled)

If you enable spread spectrum, it can significantly reduce the EMI (Electro-Magnetic Interference) generated by the system.

#### Clock Control By (Auto)

Use this item to set the CPU Host Clock frequency to Auto or by manual setting. Select "Manual" to activate the following items and set each item manually.

### 3.2.9. Load Fail-Safe Defaults Option

This option opens a dialog box that lets you install fail-safe defaults for all appropriate items in the Setup Utility:

Press <Y> and then <Enter> to install the defaults. Press <N> and then <Enter> to not install the defaults. The fail-safe defaults place no great demands on the system and are generally stable. If your system is not functioning correctly, try installing the fail-safe defaults as a first step in getting your system working properly again. If you only want to install fail-safe defaults for a specific option, select and display that option, and then press <F6>.

### **3.2.10. Load Optimized Defaults Option**

This option opens a dialog box that lets you install optimized defaults for all appropriate items in the Setup Utility. Press <Y> and then <Enter> to install the defaults. Press <N> and then <Enter> to not install the defaults. The optimized defaults place demands on the system that may be greater than the performance level of the components, such as the CPU and the memory. You can cause fatal errors or instability if you install the optimized defaults when your hardware does not support them. If you only want to install setup defaults for a specific option, select and display that option, and then press <F7>.

### **3.2.11. Set Password**

When this function is selected, the following message appears at the center of the screen to assist you in creating a password.

#### **ENTER PASSWORD**

Type the password, up to eight characters, and press <Enter>. The password typed now will clear any previously entered password from CMOS memory. You will be asked to confirm the password. Type the password again and press <Enter>. You may also press <Esc> to abort the selection.

To disable password, just press <Enter> when you are prompted to enter password. A message will confirm the password being disabled. Once the password is disabled, the system will boot and you can enter BIOS Setup freely.

#### **PASSWORD DISABLED**

If you have selected “System” in “Security Option” of “BIOS Features Setup” menu, you will be prompted for the password every time the system reboots or any time you try to enter BIOS Setup.

If you have selected “Setup” at “Security Option” from “BIOS Features Setup” menu, you will be prompted for the password only when you enter BIOS Setup.

Supervisor Password has higher priority than User Password. You can use Supervisor Password when booting the system or entering BIOS Setup to modify all settings. Also you can use User Password when booting the system or entering BIOS Setup but can not modify any setting if Supervisor Password is enabled.



**3.2.12. Save & Exit Setup Option**

Highlight this item and press <Enter> to save the changes that you have made in the Setup Utility and exit the Setup Utility. When the Save and Exit dialog box appears, press <Y> to save and exit, or press <N> to return to the main menu:

**3.2.13. Exit Without Saving**

Highlight this item and press <Enter> to discard any changes that you have made in the Setup Utility and exit the Setup Utility. When the Exit Without Saving dialog box appears, press <Y> to discard changes and exit, or press <N> to return to the main menu.

**NOTE:** If you have made settings that you do not want to save, use the “Exit Without Saving” item and press <Y> to discard any changes you have made.



## Chapter 4. Driver Installation

All the necessary drivers are included within the Drivers & Utilities CD that came packaged with your board. The display shown in the following figure should appear after inserting this CD into your CD-ROM drive, if not, enter → [My Computer] → [CD-ROM] Drive → double click [autorun.exe]. Please follow the on-screen instruction.



## 4.1. Setup Items

- **Drivers**  
Install the drivers for Windows Operating System.
- **Manual**  
View the user's manual in PDF file.
- **Utility**  
Click to enter the sub-screen for installing software like Acrobat Reader, Award Flash, DirectX, and LoFormat utility.
- **Browse CD**  
Browse the contents of this CD-ROM.
- **Close**  
Exit the CD setup Items Menu.

---

## **Appendix A. How to Get Technical Support**

---

(From our website) <http://www.abit.com.tw>

(In North America) <http://www.abit-usa.com>

(In Europe) <http://www.abit.nl>

Thank you for choosing ABIT products. ABIT sells all our products through distributors, resellers and system integrators; we have no direct sales to end-users. Before sending email for tech support please check with your resellers or integrators if you need any services, they are the ones who sold you your system and they should know best as to what can be done, how they serve you is a good reference for future purchases.

We appreciate every customer and would like to provide the best service to you. Providing fast service to our customers is our top priority. However we receive many phone calls and a huge amount of email from all over the world. At the present time it is impossible for us to respond to every single inquiry. Therefore it is quite possible that if you send an email to us that you may not receive a response.

We have done many compatibility tests and reliability tests to make sure our products have the best quality and compatibility. In case you need service or technical support, please understand the constraint we have and **always check with the reseller who sold the product to you first.**

To expedite service, we recommend that you follow the procedures outlined below before contacting us. With your help, we can meet our commitment to provide the best service to the **greatest number of ABIT customers:**

- 1. Check the Manual.** It sounds simple but we have taken a lot of care in making a well-written and thorough manual. It is full of information that doesn't only pertain to motherboards. The CD-ROM included with your board will have the manual as well as drivers. If you don't have either one, go to our Program Download Area of the Website or FTP server.
- 2. Download latest BIOS, software or drivers.** Please go to our Program Download area on our Website to check to see if you have the latest BIOS. They are developed over periods of time to fix bugs or incompatibilities. **Also please make sure you have the latest drivers from your peripheral cards makers!**
- 3. Check the ABIT Technical Terms Guide and FAQ on our Website.** We are trying to expand and make the FAQs more helpful and information rich. Let us know if you have any suggestions. For hot topics check out our HOT FAQ!
- 4. Internet Newsgroups.** They are a great source of information and many people there can offer help. ABIT's Internet News group, [alt.comp.periphs.mainboard.abit](http://alt.comp.periphs.mainboard.abit), is an ideal forum for the public to exchange information and discuss experiences they have had with ABIT products. Many times you will see that your question has already been asked before. This is a public Internet news group and it is reserved for free discussions. Here is a list of some of the more popular ones:

[alt.comp.periphs.mainboard.abit](#)  
[comp.svs.ibm.pc.hardware.chips](#)  
[alt.comp.hardware.overclocking](#)  
[alt.comp.hardware.homebuilt](#)  
[alt.comp.hardware.pc-homebuilt](#)

5. **Ask your reseller.** Your ABIT authorized distributor should be able to provide the fastest solution to your technical problem. We sell our products through distributors who sell to resellers and stores. Your reseller should be very familiar with your system configuration and should be able to solve your problem much more efficiently than we could. After all, your reseller regards you as an important customer who may purchase more products and who can urge your friends to buy from him or her as well. They integrated and sold the system to you. They should know best what your system configuration is and your problem. They should have reasonable return or refund policies. How they serve you is also a good reference for your next purchase.
6. **Contacting ABIT.** If you feel that you need to contact ABIT directly you can send email to the ABIT technical support department. First, please contact the support team for the branch office closest to you. They will be more familiar with local conditions and problems and will have better insight as to which resellers offer what products and services. Due to the huge number of emails coming in every day and other reasons, such as the time required for problem reproduction, we will not be able to reply to every email. Please understand that we are selling through distribution channels and don't have the resources to serve every end-user. However, we will try to do our best to help every customer. Please also remember that for many of our technical support team English is a second language, you will have a better chance of getting a helpful answer if your question can be understood in the first place. Be sure to use very, simple, concise language that clearly states the problem, avoid rambling or flowery language and always list your system components. Here is the contact information for our branch offices:
7. **RMA Service.** If your system has been working but it just stopped, but you have not installed any new software or hardware recently, it is likely that you have a defective component. Please contact the reseller from whom you bought the product. You should be able to get RMA service there.
8. **Reporting Compatibility Problems to ABIT.** Because of tremendous number of email messages we receive every day, we are forced to give greater weight to certain types of messages than to others. For this reason, any compatibility problem that is reported to us, giving detailed system configuration information and error symptoms will receive the highest priority. For the other questions, we regret that we may not be able to reply directly. But your questions may be posted to the Internet news group in order that a larger number of users can have the benefit of the information. Please check the news group from time to time.

|   |  |
|---|--|
| <p><b>North America and South America</b></p> <p><b>RMA Center</b></p>  | <p><b>ABIT Computer (U.S.A.) Corporation</b><br/> 45531 Northport Loop West, Fremont CA, 94538, U.S.A.<br/> Tel: 1-510-623-0500<br/> Fax: 1-510-623-1092<br/> Sales: <a href="mailto:sales@abit-usa.com">sales@abit-usa.com</a><br/> Latin America Sales: <a href="mailto:ventas@abit-usa.com">ventas@abit-usa.com</a><br/> Marketing: <a href="mailto:marketing@abit-usa.com">marketing@abit-usa.com</a><br/> Web Site: <a href="http://www.abit-usa.com">http://www.abit-usa.com</a></p> <p>46808 Lakeview Blvd. Fremont, CA 94538, U.S.A.</p> |
| <p><b>UK and Ireland</b></p>  | <p><b>ABIT Computer (U.K.) Corporation Ltd.</b><br/> Unit 3, 24-26 Boulton Road, Stevenage, Herts SG1 4QX, UK<br/> Tel: 44-1438-228888<br/> Fax: 44-1438-226333<br/> E-mail: <a href="mailto:sales@abitcomputer.co.uk">sales@abitcomputer.co.uk</a></p>  |
| <p><b>Germany and Benelux (Belgium, Netherlands, Luxembourg), France, Italy, Spain, Portugal, Greece, Denmark, Norway, Sweden, Finland, and Switzerland</b></p>           | <p><b>AMOR Computer B.V. (ABIT's European Office)</b><br/> Jan van Riebeeckweg 15, 5928LG, Venlo, The Netherlands<br/> Tel: 31-77-3204428<br/> Fax: 31-77-3204420<br/> Sales: <a href="mailto:sales@abit.nl">sales@abit.nl</a><br/> Web Site: <a href="http://www.abit.nl">http://www.abit.nl</a></p>  |
| <p><b>Austria, Czech, Romania, Bulgaria, Slovakia, Croatia, Bosnia, Serbia, and Macedonia</b></p>   | <p><b>Asguard Computer Ges.m.b.H</b><br/> Schmalbachstrasse 5, A-2201 Gerasdorf / Wien, Austria<br/> Tel: 43-1-7346709<br/> Fax: 43-1-7346713<br/> E-mail: <a href="mailto:asguard@asguard.at">asguard@asguard.at</a></p>  |
| <p><b>Shanghai</b></p>  | <p><b>ABIT Computer (Shanghai) Co. Ltd.</b><br/> Tel: 86-21-6235-1829<br/> Fax: 86-21-6235-1832<br/> Web Site: <a href="http://www.abit.com.cn">http://www.abit.com.cn</a></p>   |
| <p><b>Russia and CIS</b></p>  | <p><b>ABIT Computer (Russia) Co. Ltd.</b><br/> Sales: <a href="mailto:sales@abit.ru">sales@abit.ru</a><br/> Info: <a href="mailto:info@abit.ru">info@abit.ru</a><br/> Web Site: <a href="http://www.abit.ru">http://www.abit.ru</a></p>  |
| <p><b>Poland</b></p>  | <p><b>ABIT Computer (Poland) Co. Ltd.</b><br/> Przedstawicielstwo w Polsce ul. Wita Stwosza 28, 50-149 Wroclaw<br/> Tel: 48 71 780 78 65 / 66<br/> Fax: 48 71 372 30 87</p>  |
| <p><b>Japan</b></p>   | <p>Web Site: <a href="http://www.abit4u.jp">http://www.abit4u.jp</a></p>   |
| <p><b>Taiwan Head Office</b><br/> <i>(Serving all other territories not listed above. Taiwan is 8+ GMT time, and may have different holiday calendar from yours.)</i></p> | <p><b>ABIT Computer Corporation</b><br/> No. 323, Yang Guang St., Neihu, Taipei, 114, Taiwan<br/> Tel: 886-2-8751-8888<br/> Fax: 886-2-8751-3382<br/> Sales: <a href="mailto:sales@abit.com.tw">sales@abit.com.tw</a><br/> Marketing: <a href="mailto:market@abit.com.tw">market@abit.com.tw</a><br/> Web Site: <a href="http://www.abit.com.tw">http://www.abit.com.tw</a></p>  |



# Technical Support Form

**Company Name:**

**Phone Number:**

**Contact Person:**

**Fax Number:**

**E-mail Address:**

|                       |  |                |   |
|-----------------------|--|----------------|---|
| Model                 | *  | BIOS ID #      | * |
| Motherboard Model No. |  | DRIVER REV     |   |
| OS/Application        | *  |                |   |
|                       |  |                |   |
| Hardware Name         | Brand  | Specifications |   |
| CPU                   | *  |                |   |
| HDD                   | <input type="checkbox"/> IDE1<br><input type="checkbox"/> IDE2 |                |   |
| CD-ROM-Drive          | <input type="checkbox"/> IDE1<br><input type="checkbox"/> IDE2 |                |   |
| System Memory         |  |                |   |
| ADD-ON CARD           |  |                |   |
|                       |  |                |   |
|                       |  |                |   |
|                       |  |                |   |
|                       |  |                |   |

Problem Description:

---



---



---



---



---



---



---



---



---



---

