

s661FXm-7US / s661GXm-7US / s661GXm-7U

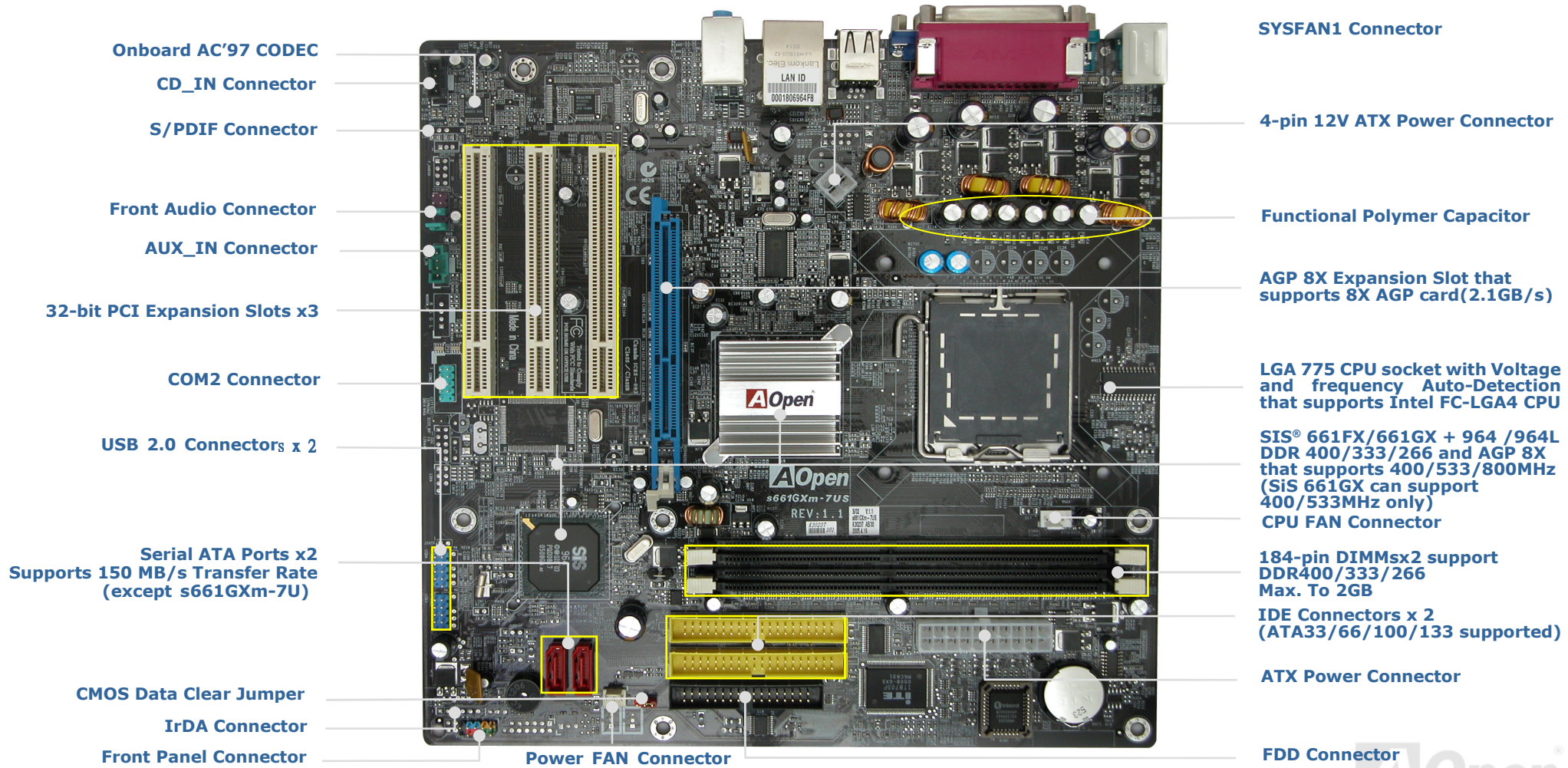
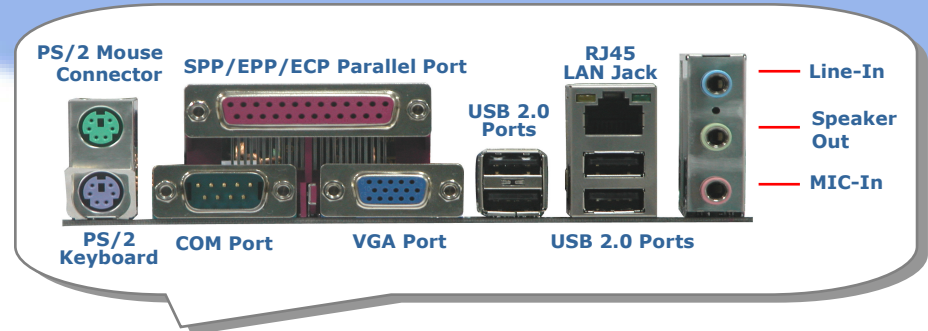

Before You Start

Everything you need to boot this motherboard is included in this Easy Installation Guide. Thanks for the help of saving our earth.

Installing By Yourself

Accessory Checklist

- **Easy Installation Guide x 1**
- **80-Wire IDE Cable x 1**
- **Floppy Drive Cable x 1**
- **Serial ATA Power Cable x 1**
(except s661GXm-7U)
- **Serial ATA Cable x 1**
(except s661GXm-7U)
- **Bonus Pack CD x 1**
- **I/O Shield x 1**

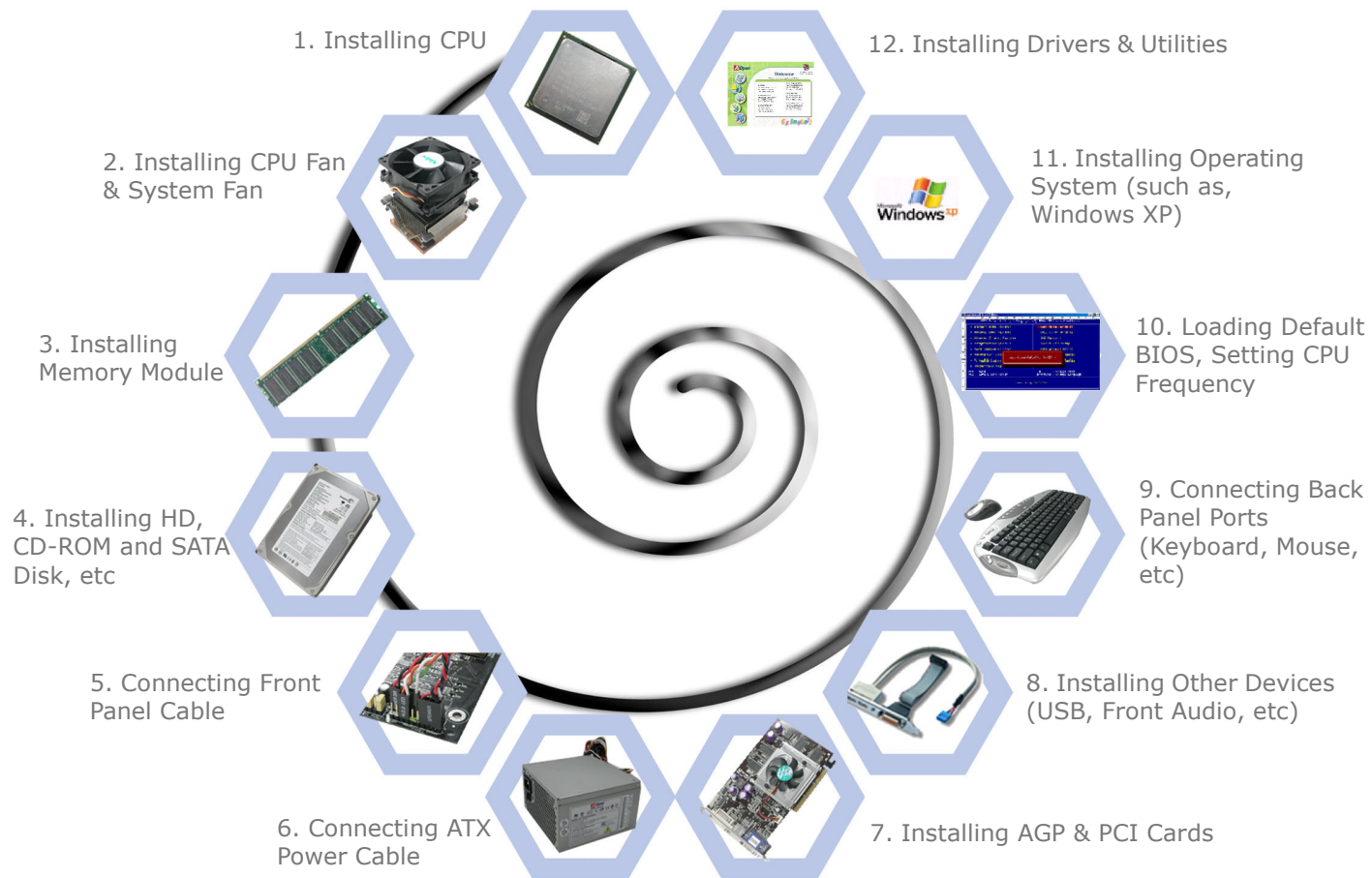

*There will be different features for each model.



1. Installing CPU

This socket supports FC-LGA4 CPU, which is the latest CPU package developed by Intel. Other forms of CPU package are impossible to be fitted in.

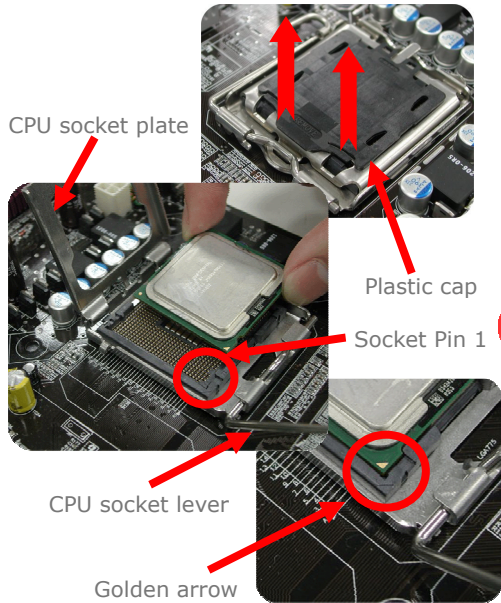

1. Pull CPU socket lever and plate up.
2. Remove plastic cap from CPU socket plate.
3. Locate Pin 1 in the socket and look for a golden arrow on the CPU upper interface. Match Pin 1 and golden arrow. Then insert the CPU into the socket.
4. Press down CPU socket plate and lever to finish CPU installation.

Warning: If you do not match the CPU socket Pin 1 and CPU golden arrow well, you may damage the CPU. And please don't touch CPU socket pins when installing CPU.

Note: It's strongly recommended by Intel to use thermal paste properly to avoid over-heat generated From Prescott CPU.

2. Installing CPU & System Fans

Plug in the CPU fan cable to the 3-pin CPUFAN connector. If you have chassis fan, you can also plug it in SYSFAN1 or SYSFAN2 connector.

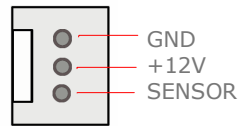
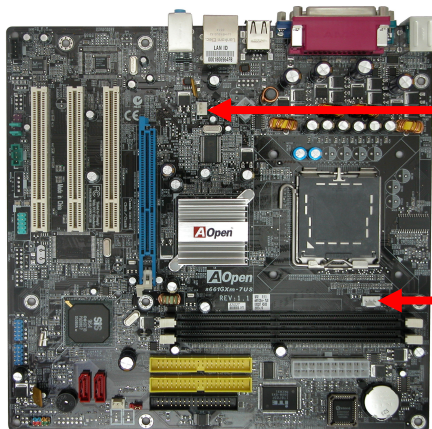

SYSFAN1 Connector

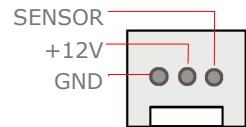

CPUFAN Connector

Note: Some CPU fans do not have sensor pin so they cannot support fan monitoring.

3. Installing Memory Modules

DIMM slots are designed in dark black which are very easy to recognize. Insert the module straight down to the DIMM slot with both hands and press down firmly until the DIMM module is securely in place.

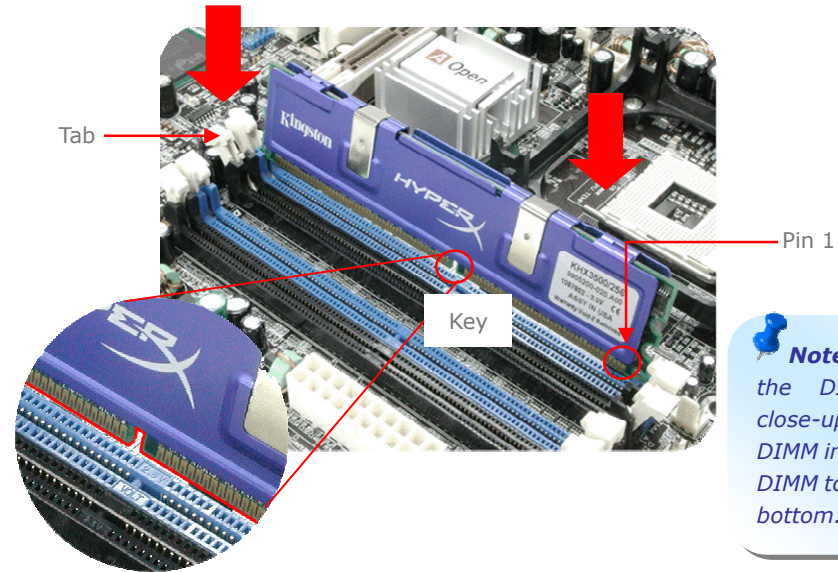

Note: The tabs of the DIMM slot will close-up to hold the DIMM in place when the DIMM touches the slot's bottom.

4. Connecting IDE and Floppy Cables

Connect 34-pin floppy cable and 40-pin, 80-wire IDE cable to floppy connector FDD and IDE connector. Be careful of the pin1 orientation. Wrong orientation may cause system damage.

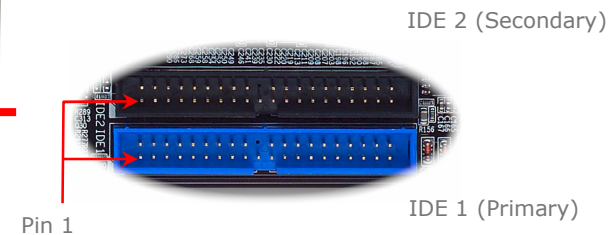
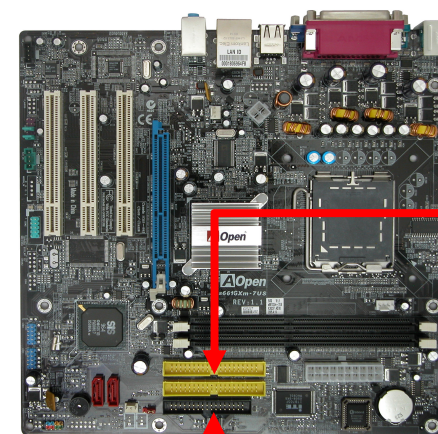

FDD Connector

5. Connecting Front Panel cable

Attach the power LED, speaker, and reset switch connectors to the corresponding pins. If you enable "Suspend Mode" item in BIOS Setup, the ACPI & Power LED will keep flashing while the system is in suspend mode.

Locate the power switch cable from your ATX housing. It is 2-pin female connector from the housing front panel. Plug this connector to the soft-power switch connector marked *SPWR*.

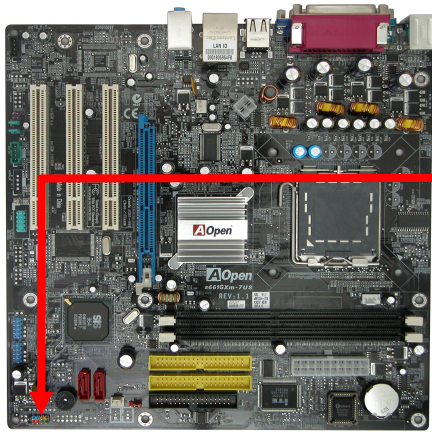

Pin1

HD_LED_P	FP PWR/SLP
HD_LED_N	FP PWR/SLP
RST_SW_N	PWR_SW_P
RST_SW_P	PWR_SW_N
RSVD	NC

Front Panel Connector

6. Connecting ATX Power Cables

This motherboard comes with a 20-pin and 4-pin ATX power connector as shown below. Make sure you plug in the right direction. We strongly recommend you to insert the 4-pin connector before connecting the 20-pin connector.

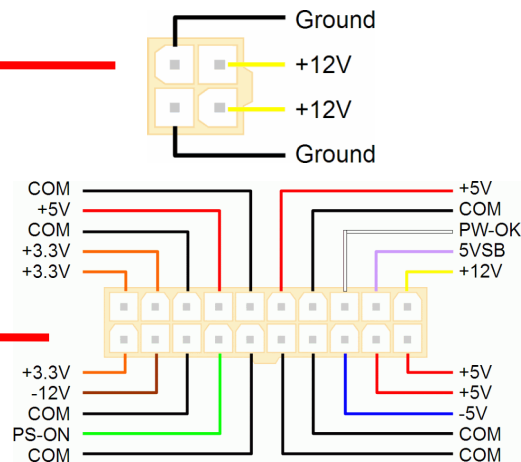
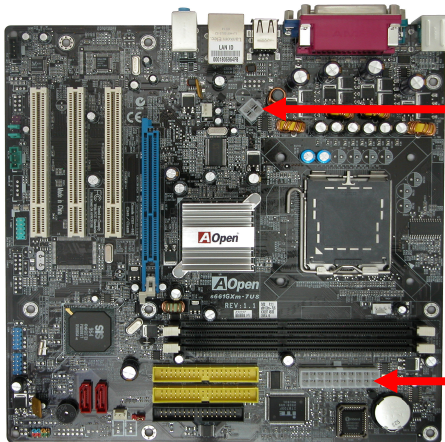

7. Power-on and Loading BIOS Setup

Del

After you finish the setting of jumpers and connect correct cables. Power on and enter the BIOS Setup, press during POST (Power On Self Test). Choose "Load Setup Defaults" for recommended optimal performance.

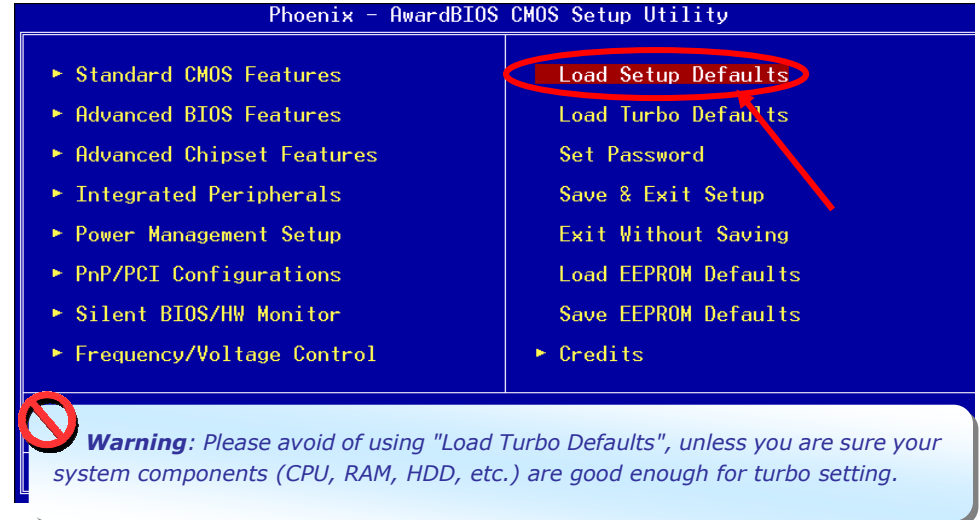

8. AOpen Bonus Pack CD and EzInstall

You can use the auto-run menu of Bonus CD disc. Choose the utility and driver from the icons at left side, and then click on the "Setup" button to complete installation automatically.



Setting CPU Voltage & Frequency

Setting CPU Core Voltage

This motherboard supports Voltage ID (VID) function to detect CPU voltage automatically during power-on. It's not necessary to set CPU core voltage.

Setting CPU Frequency

This motherboard is CPU jumper-less design, you can set CPU frequency through 1MHz stepping CPU Overclocking in the BIOS. CPU Core Frequency = CPU FSB clock x CPU Ratio. However, all CPU now selling in the market belong to "Fixed Multiplier". That means users can not adjust the CPU Ratio but only change CPU FSB clock to achieve overclocking.

(Users do the overclocking at their own risk!!)

BIOS Setup > Frequency / Voltage Control > CPU Speed Setup

CPU Ratio	8x, 10x... 24x, 25x, 26x, 27x, 28x
CPU FSB (Adjustment manually)	FSB = 100MHz-400MHz by 1MHz Stepping CPU Overclocking

Processor Number	Processor Frequency	FSB	CPU Ratio	Cache
5 Series				
570	3.80G	800MHZ	19x	1MB L2
560	3.60G	800MHZ	18x	1MB L2
550	3.40G	800MHZ	17x	1MB L2
540	3.20G	800MHZ	16x	1MB L2
530	3.00G	800MHZ	15x	1MB L2
520	2.80G	800MHZ	14x	1MB L2
3 Series				
350	3.20G	533MHZ	24x	256K L2
345	3.06G	533MHZ	23x	256K L2
340	2.93G	533MHZ	22x	256K L2
335	2.80G	533MHZ	21x	256K L2

Note: With CPU speed changing rapidly, there might be faster CPU on the market by the time you received this installation guide. This table is kindly for your references only.



Note: Some CPU fans do not have sensor pin so they cannot support fan monitoring.



Note: SiS 661FX/661GX chipset support Prescott processor. Prescott processor could detect the clock ratio automatically; you may not be able to adjust the clock ratio in BIOS manual.



Warning: SiS 661FX chipset support maximum 800MHz (200MHz*4) system bus; SiS 661GX support maximum 533MHz only; higher clock setting may cause serious system damage.

JP14 Clear CMOS

You can clear CMOS to restore system default setting. To clear the CMOS, follow the procedure below.

1. Turn off the system and unplug the AC power.
2. Remove ATX power cable.
3. Short pins 2-3 for a few seconds.
4. Return to its normal setting by shorting pin 1 & pin 2.
5. Connect ATX power cable back.

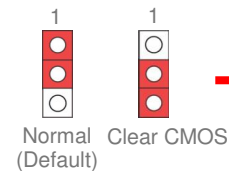
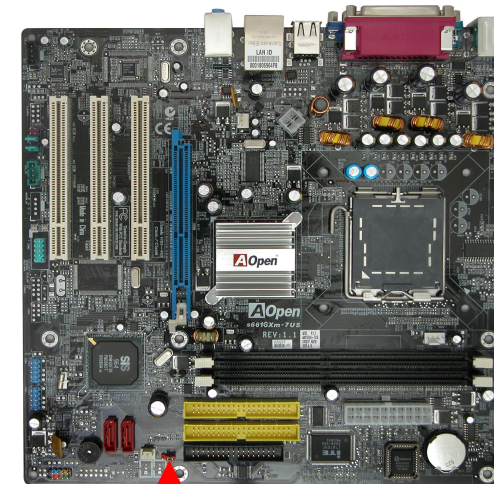

Tip: When should I Clear CMOS?

1. Boot fails because of overclocking...
2. Forget password...
3. Troubleshooting...

USB 2.0 Connectors

This motherboard provides eight USB 2.0 ports to connect USB devices, such as mouse, keyboard, modem, printer, etc. There are four ports on the back panel. You can use proper cables to connect the Front USB connector to USB modules or front panel of chassis.

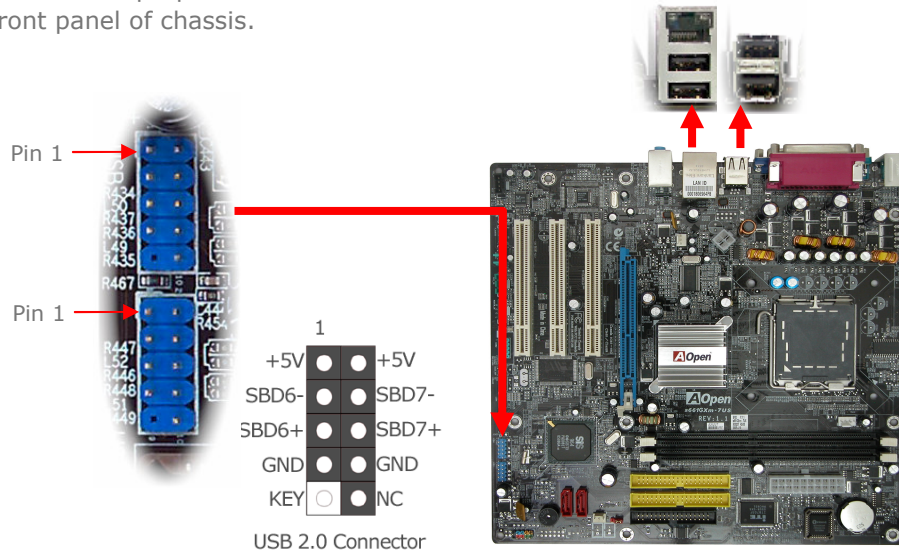

Front Audio Connectors

If the housing has been designed with an audio port on the front panel, you'll be able to connect onboard audio to front panel through this connector. By the way, please remove 5-6 and 9-10 jumper caps from the Front Audio Connector before connecting the cable. Please do not remove these 5-6 and 9-10 yellow jumper caps if there's no audio port on the front panel.

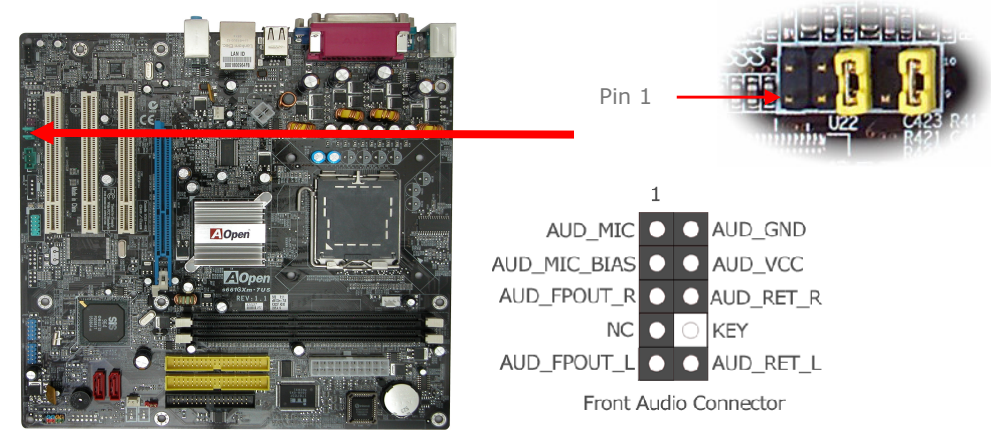

IRDA Connector

The IrDA connector can be configured to support wireless infrared module, with this module and application software such as Laplink or Windows Direct Cable Connection, user can transfer files to or from laptops, notebooks, PDA devices and printers. This connector supports both HPSIR (115.2Kbps, 2 meters) and ASK-IR (56Kbps).

Install an infrared module onto the IrDA connector and enable the infrared function from BIOS Setup, UART Mode, you can use this function. Please make sure you connect correct orientation when plugging IrDA module.

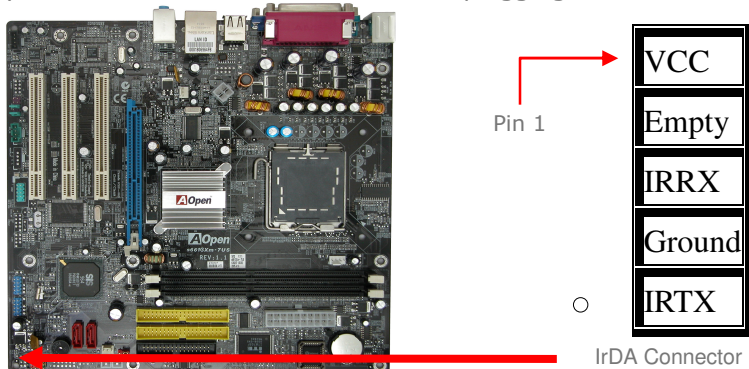

Serial ATA Connectors

To connect a serial ATA disk, you have to have a 7-pin serial ATA cable. Connect two ends of the serial ATA cable to the serial ATA header on the motherboard and the disk. Like every other traditional disk, you also have to connect a power cable. Please be noted that it is a jumper free implement; you don't need to set jumpers to define a master or slave disk. When serial ATA hard disks are installed on serial ATA ports, the one connected on SATA1 will be set as the first boot device automatically. **Please note that it doesn't support Hot-Plug in function.**

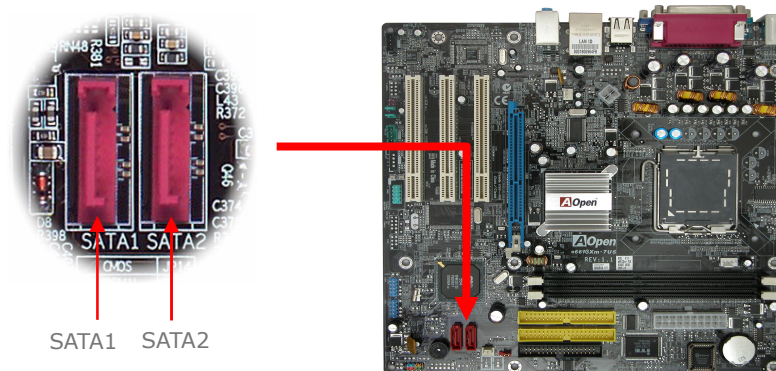



Troubleshooting

If you encounter any trouble to boot your system, follow the procedures accordingly to resolve the problem.

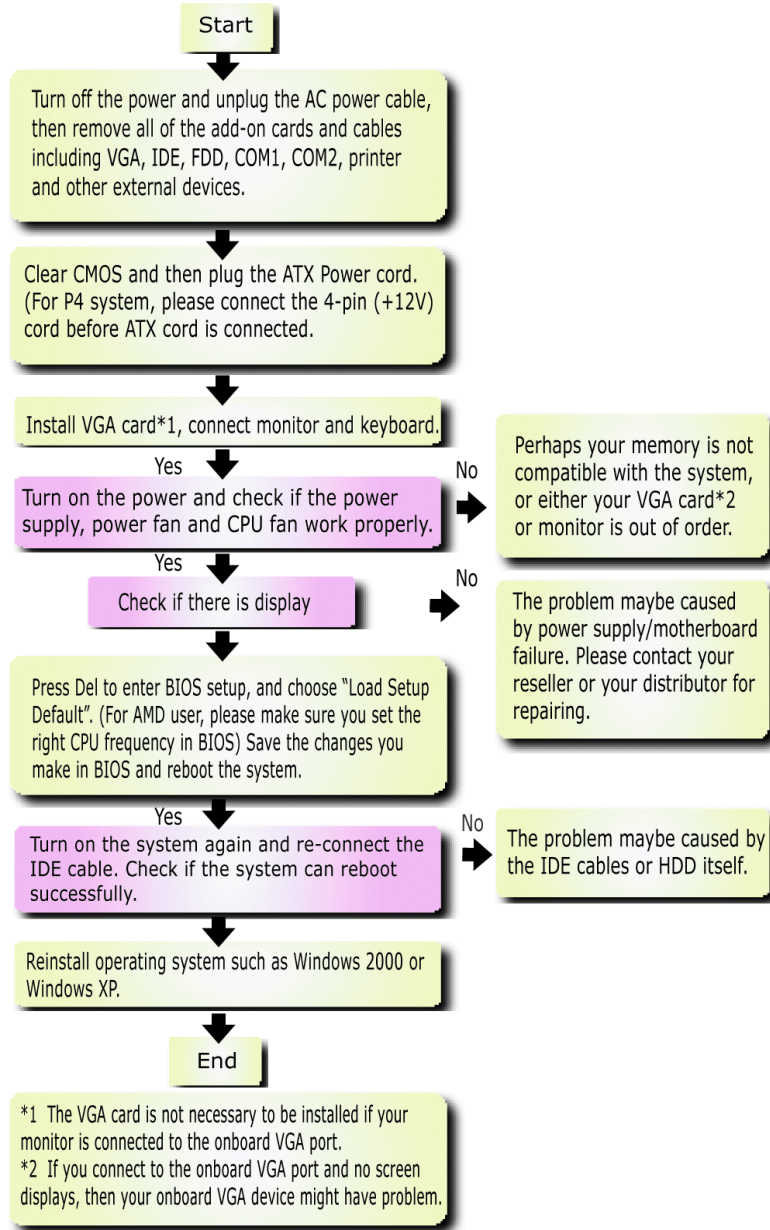

Model name and BIOS version

Model name and BIOS version can be found on upper left corner of first boot screen (POST screen). For example:

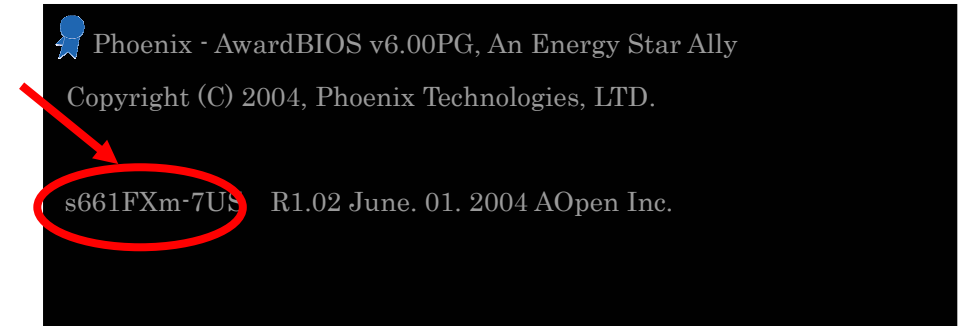

s661FXm-7US is model name of motherboard; R1.02 is BIOS version

Register Your Motherboard

Thanks for choosing AOpen product, please register this motherboard at <http://club.aopen.com.tw/productreg/> to become a Gold member of Club AOpen, and to ensure high service quality and priority from AOpen. You will also have a chance to play slot machine game to win prize from AOpen. Please prepare the following information before you start: **Model Name, Part Number (P/N), Serial Number (S/N) and Purchase Date.** The Part Number and Serial number are printed on bar code label. You can find this bar code label on the outside packing or on component side of PCB. For example:

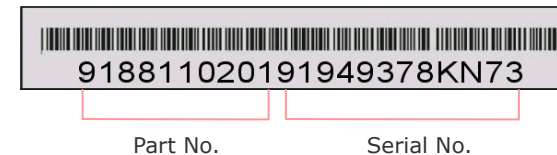

P/N: 91.88110.201 is part number, **S/N: 91949378KN73** is serial number.



Technical Support

Dear Customer,

Thanks for choosing AOpen products. We invite you to register at <http://www.aopen.com> to become a Gold Member of Club AOpen so as to ensure quality service in the future. In order to maintain the best service to every customer of us, we recommend you to follow the procedures below and seek help from our branches according to the region you buy the product. With your help, we can then continue to provide efficient and the best quality service to every customer.

Thanks very much for your understanding!

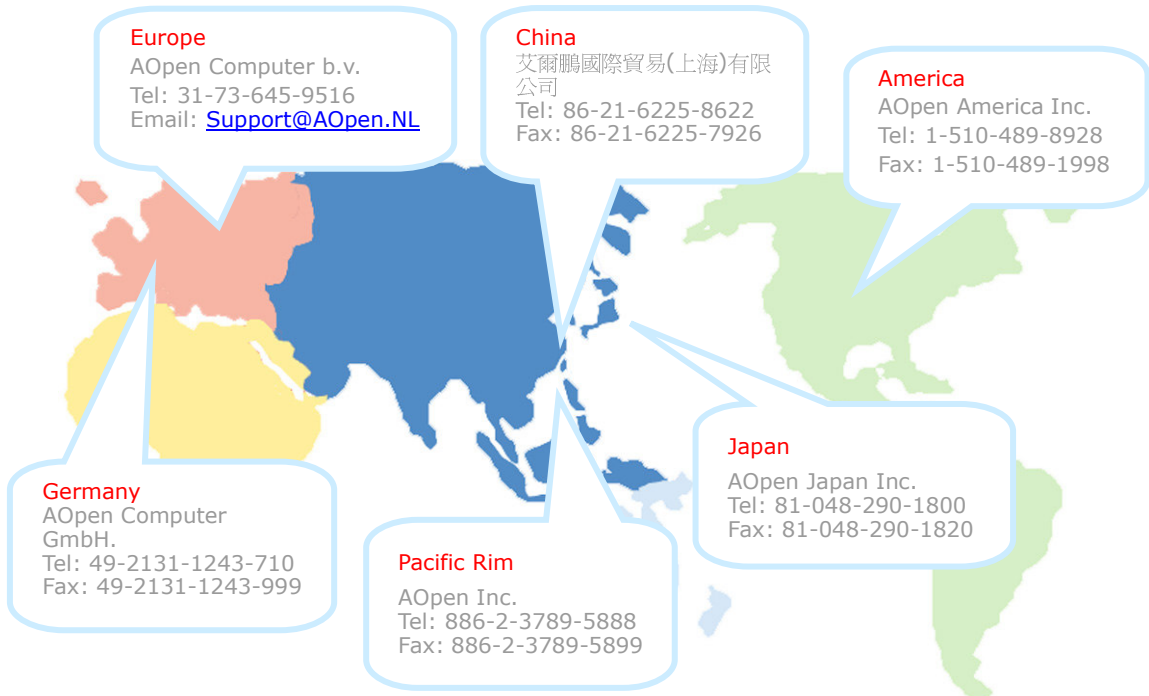

Europe Email: Support@AOpen.NL
Pacific Rim <http://www.aopen.com.tw/tech/default.htm>
China: <http://www.aopen.com.cn/tech/default.htm>
Germany <http://www.aopencom.de/tech/default.htm>
America <http://usa.aopen.com/tech/default.htm>
Japan <http://www.aopen.co.jp/tech/default.htm>

Online Manual: To download manual, please log on and then select your preferred language. Under "Type" directory, choose "Manuals" to go to our manual database. You can also find the manual and EIG in AOpen Bonus Pack.
<http://download.aopen.com.tw/downloads>

Test Report: We recommend you to choose board/card/device from the compatibility test reports for assembling your PC. It may prevent incompatibility problems.
<http://english.aopen.com.tw/tech/report/default.htm>

FAQ: Here we list problems that users often encounter and FAQ (Frequently Asked Questions). You may select your preferred language after log on, and may be able to find a solution to your problem.
<http://club.aopen.com.tw/faq/>

Download Software: After log on and having language selected, you may get the latest updated BIOS/utility and drivers you need under "Type" directory. In most case, newer versions of drivers and BIOS have solved earlier bugs or compatibility problems.
<http://download.aopen.com.tw/downloads>

eForum: AOpen eForum is provided to discuss our products with other users, in which your problem probably had been discussed before or will be answered. After log on, you may select your preferred language under "Multi-language".
<http://club.aopen.com.tw/forum>

Contact Us: Please prepare detail system configuration and error symptom before contacting us. The part number, serial number and BIOS version are also very helpful.

Contact Distributors/Resellers: We sell our products through resellers and integrators. They should know your system configuration very well and should be able to solve your problem efficiently and provide important reference for you.