



## Item Checklist

This item checklist is only available for retail market. Completely check your package, If you discover damaged or missing items, contact your retailer.

- Superb 4V series mainboard
- QDI Utility CD
- User's manual
- IDE ribbon cable
- Floppy ribbon cable
- I/O shield(option)
- Cable with bracket for USB Connectors(option)



### Notice

The information in this document is subject to change in order to improve reliability, design, or function without prior notice and does not represent a commitment on the part of this company. In no event will we be liable for direct, indirect, special, incidental, or consequential damages arising out of the use or the possibility of such damages.

All trademarks are the property of their respective owners.

If you need any further information, please visit our web-site: "[www.qdigrp.com](http://www.qdigrp.com)".



# Declaration of conformity



**QUANTUM DESIGNS(HK) LTD.**  
**20th Floor, Devon House, Taikoo Place, 979 King's Road,**  
**Quarry Bay, Hong Kong**

declares that the product

**Mainboard**  
**Superb 4V**

is in conformity with

(reference to the specification under which conformity is declared in  
accordance with 89/336 EEC-EMC Directive)

- EN 55022 Limits and methods of measurements of radio disturbance characteristics of information technology equipment
- EN 50081-1 Generic emission standard Part 1:  
Residential, commercial and light industry
- EN 50082-1 Generic immunity standard Part 1:  
Residential, commercial and light industry

European Representative:

QDI COMPUTER (UK) LTD

QDI SYSTEM HANDEL GMBH

QDI COMPUTER (FRANCE) SARL

LEGEND QDI SPAIN S.L

QDI COMPUTER ( SCANDINAVIA ) A/S

QDI EUROPE B. V.

QDI COMPUTER HANDELS GMBH

QDI COMPUTER (SWEDEN) AB

Signature :

Place / Date : HONG KONG/2002

Printed Name : Xu Wenge

Position/ Title : Assistant President





# Declaration of conformity



Trade Name: QDI Computer ( U . S . A . ) Inc.  
Model Name: **Superb 4V**  
Responsible Party: QDI Computer ( U . S . A . ) Inc.  
Address: 41456 Christy Street  
Fremont, CA 94538  
Telephone: (510) 668-4933  
Facsimile: (510) 668-4966

Equipment Classification: FCC Class B Subassembly  
Type of Product: Mainboard  
**Manufacturer: Quantum Designs (HK) Inc.**  
Address: 20th Floor, Devon House, Taikoo Place  
979 King's Road, Quarry Bay, HONG  
KONG

## Supplementary Information:

This device complies with Part 15 of the FCC Rules. Operation is subject to the following two conditions : (1) this device may not cause harmful interference, and (2) this device must accept any interference received, including interference that may cause undesired operation.

Tested to comply with FCC standards.

Signature : Xu Wengze

Date : 2002



# CONTENTS

<b>Chapter 1 .....</b>	<b>1</b>
Key Features .....	2
Main Expansion Slots and Connectors .....	4
<b>Chapter 2 .....</b>	<b>5</b>
External Connectors .....	6
PS/2 Keyboard/Mouse Connector .....	6
USB1, USB2 and LAN Connectors .....	6
Line-in jack, Microphone-in jack, Speaker-out jack and MIDI/Joystick Connector .....	7
Parallel Port, Serial Port Connectors .....	7
ATX12V Power Supply Connector & Power Switch (POWER SW) .....	8
Hard Disk LED Connector (HD_LED) .....	9
Reset Switch (RESET) .....	9
Speaker Connector (SPEAKER) .....	9
Power LED Connector (PWR_LED) .....	9
GREENLED Connector (GREEN_LED) .....	9
USB3,4;USB5,6 .....	10
ACPI LED Connector (ACPI_LED) .....	10
Hardware Green Connector (SLEEP SW) .....	10
Fan Connectors (BAKFAN, CPUFAN, CHSFAN) .....	11
Infrared Header (IrDA) .....	11
Wake-Up On Internal Modem (WOM) .....	12
Wake-Up On LAN (WOL) .....	12
4-pin SMBus Connector (SMBUS) .....	13
Audio Connectors (CD_IN, MODEM) .....	13
Audio Interface (Optional) .....	14
Communication and Networking Riser Slot (CNR) .....	15
Onboard VGA Connector (JVIDEO) .....	15
Jumper Settings .....	16
Enable Front/Back Panel USB Device Wake-up Function (JUSB1/JUSB2) .....	16
Clear CMOS (JCC) .....	17
Enable/Disable onboard audio (JSD) .....	17
BIOS-Protection Jumper (JAV) .....	18



<b>Chapter 3 .....</b>	<b>19</b>
Utility Support .....	20
AWDFLASH.EXE .....	20
AWARD(Phoenix) BIOS Description .....	21
Entering Setup .....	21
Load Optimized Defaults .....	21
Standard CMOS Features Setup .....	21
QDI Innovation features .....	25
Advanced BIOS Features Setup .....	27
Advanced Chipset Features Setup .....	30
Power Management Setup .....	32
PNP/PCI Configuration Setup .....	35
Integrated Peripherals .....	36
PC Health Status .....	40
Password Setting .....	41
Boot with BIOS defaults .....	41
<b>Appendix .....</b>	<b>42</b>
QDI Utility CD .....	42
Norton AntiVirus .....	42
LogoEasy II .....	44
RecoveryEasy II .....	46
SpeedEasy II .....	51
BootEasy .....	52
StepEasyII .....	53
BIOS-ProtectEasy .....	54
QDI BootEasy(German) .....	55
S4V(Spanish) .....	56
S4V (French) .....	59
S4V (Italian) .....	63
Layout	





**Be sure to add some Silicone Grease between the CPU and the heatsink of FAN to keep them fully contact , meanwhile to meet the heat sink requirement.**



**Be sure to add some Silicone Grease between the CPU and the heatsink to keep them fully contacted to meet the heat sink requirement.**



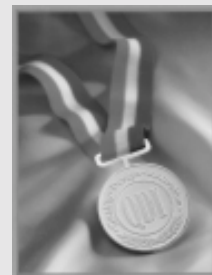

**This manual is suitable for mainboards of Superb 4V series. Each mainboard is carefully designed for the PC user who wants diverse features.**

**-A: with onboard Audio**

**-L: with onboard LAN**





---

-- This page is intentionally left blank --





# Chapter 1

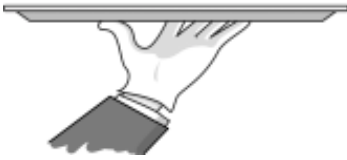

## Introduction

---

Superb 4V series of mainboards utilize ( SIS 651 + SIS 962L) chipset, providing a fully compatible, high performance and cost-effective ATX platform. The new integrated technologies, together with AGP 4X support, AC'97 audio, onboard VGA connector, integrated LAN(optional), 6 USB ports, and ATA133/100/66/33, give customers an advanced, multimedia solution at reasonable price. It provides 400/533MHz host bus speed to support Intel® Pentium 4 socket 478 processors and the largest DDR memory capacity is up to 3GB. It also provides advanced features such as Wake up by USB devices, Wake-on-LAN, Wake-on-Modem, ACPI function. Suspend to RAM, the optimal implementation of the Advanced Configuration and Power Interface (ACPI) specification, makes the PC's power consumption drop to the lowest possible level and enable quick wakeup. BootEasy, QDI innovation, lets the PC boot freely and rapidly.

---





## **Key Features**

### **Form factor**

- ATX form factor of 305mm x 224mm

### **Microprocessor**

- Supports Intel® Pentium 4 (Willamette) socket 478 processors at 1.4/1.5/1.6/1.7/1.8/1.9/2.0GHz and above
- Supports Intel® Pentium 4 (Northwood) socket 478 processors at 1.6/1.8/2.0/2.2/2.26/2.4GHz and above
- Supports Intel® Celeron (Willamette) socket 478 processors at 1.7/1.8GHz and above
- Supports 400/533MHz host bus speed

### **System memory**

- Provides three 184-pin DDR SDRAM interfaces
- Supports DDR200/DDR266/DDR333 SDRAM
- Supports 64/128/256/512Mb technology up to 3GB

### **Onboard IDE**

- Supports Independent timing of up to 4 drives
- Supports Ultra ATA 33/66/100/133, PIO mode
- Two fast IDE interfaces supporting four IDE devices including IDE hard disks and CDROM drives

### **Onboard LAN**

**( available on -L, -AL mainboard )**

- 10/100 Mbit/sec Ethernet support
- 10/100M LAN interface built-in on board

### **6 USB**

- USB 2.0 compliant, operates at 480Mbps, about 40X times faster than USB 1.1 which currently works at a snails pace of just 12Mbps
- Supports wake-up from S1 (power on suspend), S3(depends on device)

### **AGP Interface**

- AGP 1.5V Connector supports AGP 2.0 including AGP 4x data transfers
- Provides one 2X8Pin onboard VGA connector



### Onboard Audio(Optional)

AC'97 Audio( **available on -A,-AL, )**

- AC'97 2.1 Specification Compliant
- Provides onboard Line-in Jack, Microphone-in Jack, Speaker-out Jack with onboard amplifier and MIDI/Joystick Connector

### Onboard I/O

- One floppy port supporting up to two 3.5" or 5.25" floppy drives with 360K/720K/1.2M/1.44M/2.88M format
- Two high speed 16550 compatible UARTs (COM1/COM2/COM3/COM4 selective) with 16 byte send/receive FIFO
- One parallel port supports SPP/EPP/ECP mode
- Infrared interface
- All I/O ports can be enabled/disabled in the BIOS setup

### BIOS

- Licensed advanced AWARD(Phoenix) BIOS, supports flash ROM, plug and play ready
- Supports IDE CDROM/SCSI boot up

### Green function

- Supports ACPI (Advanced Configuration and Power Interface) and ODPM (OS Directed Power Management)
- Supports ACPI power status: S0 (full-on), S1 (power on suspend), S3 (suspend to RAM), S4(suspend to Disk,depends on OS) and S5 (soft-off)

### Expansion slots

- 1 AGP slot
- 6 PCI slots
- 1 CNR slot





**Advanced features**

- PCI 2.2 Specification Compliant
- Provides Trend ChipAwayVirus On Guard
- Supports Windows 98/2000/ME/XP soft-off
- Supports Wake-on-LAN and Wake-on-Modem
- Supports system monitoring(monitors CPU and system temperatures, system voltages, fan speed)
- Providing QDI innovations: RecoveryEasyII, BIOS-ProtectEasy, LogoEasyII, BootEasy, StepEasyII(Optional), SpeedEasyII

**Main Expansion Slots and Connectors**

Slot/Port (Quantity)	Description
PCI(6)	PCI slots
CNR(1)	CNR slot
AGP(1)	AGP slot
IDE(2)	IDE ports
FLOPPY(1)	Floppy Drive port
DDR(3)	DDR sockets
USB(6)	USB connectors
UART(2)	UART connectors
PARALLEL(1)	Parallel connector
IrDA(1)	IrDA connector



**Note:**

---

*Our technology is now being upgraded, the description and Interface for Easy technology in this manual are only for your reference. If you would like to get the upgraded version, please download the latest BIOS or the utility from the website to re-flash your mainboard; if your mainboard supports the latest version Easy technology, refer to the webpage for functions and detailed operation of the technology.*

---





## Chapter 2



### Installation Instructions

---

---

This section covers External Connectors and Jumper Settings. Refer to the mainboard layout chart for locations of all jumpers, external connectors, slots and I/O ports. Furthermore, this section lists all necessary connector pin assignments for your reference. The particular state of the jumpers, connectors and ports are illustrated in the following figures. Before setting the jumpers or inserting these connectors, please pay attention to the directions.

---

---





## **External Connectors**

### **PS/2 Keyboard/Mouse Connector**

PS/2 keyboard connector is for the usage of PS/2 keyboard. If using a standard AT size keyboard, an adapter should be used to fit this connector. PS/2 mouse connector is for the usage of PS/2 mouse.

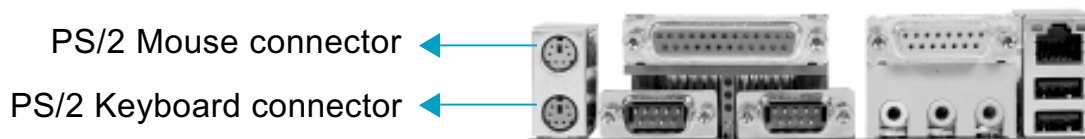

### **USB1, USB2 and LAN Connectors**

( LAN connector is only available on -L, -AL )

Two USB ports are for connecting USB devices. The RJ-45 connector is for onboard LAN.



**Warning:**

---

*Be sure to unplug the AC power supply before adding or removing expansion cards or other system peripherals, otherwise your mainboard and expansion cards might be seriously damaged.*

---



### Line-in jack, Microphone-in jack, Speaker-out jack and MIDI/Joystick Connector

(available on -A, -AL)

The Line-in jack can be connected to devices such as a cassette or minidisc player to playback or record. The Microphone-in jack can be connected to a microphone for voice input. The Speaker-out jack allows you to connect speakers or headphones for audio output from the internal amplifier. The MIDI/Joystick connector allows you to connect a game joystick or a MIDI device.

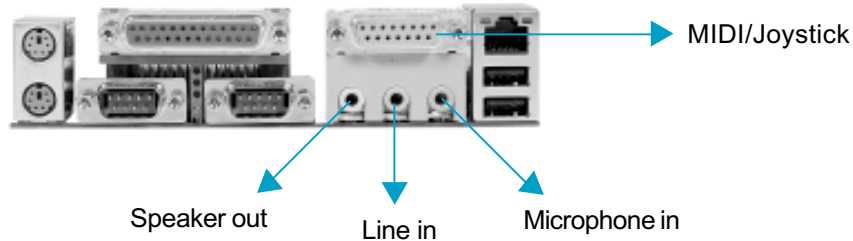

### Parallel Port, Serial Port Connectors (UART1, UART2)

The parallel port connector can be connected to a parallel device such as a printer. The serial port UART1,2 connectors can be connected to a serial port device such as a serial port mouse. You can enable/disable them and choose the IRQ or I/O address in “Integrated Peripherals” from AWARD BIOS SETUP.





### ATX12V Power Supply Connector & Power Switch (POWER SW)

Be sure to connect the power supply plug to this connector in its proper orientation. The power switch (POWER SW) should be connected to a momentary switch. When powering up your system, first turn on the mechanical switch of the power supply (if one is provided), then push once the power switch. When powering off the system, you needn't turn off the mechanical switch, just ***Push once\**** the power switch. Superb 4V series mainboard only support ATX12V power.

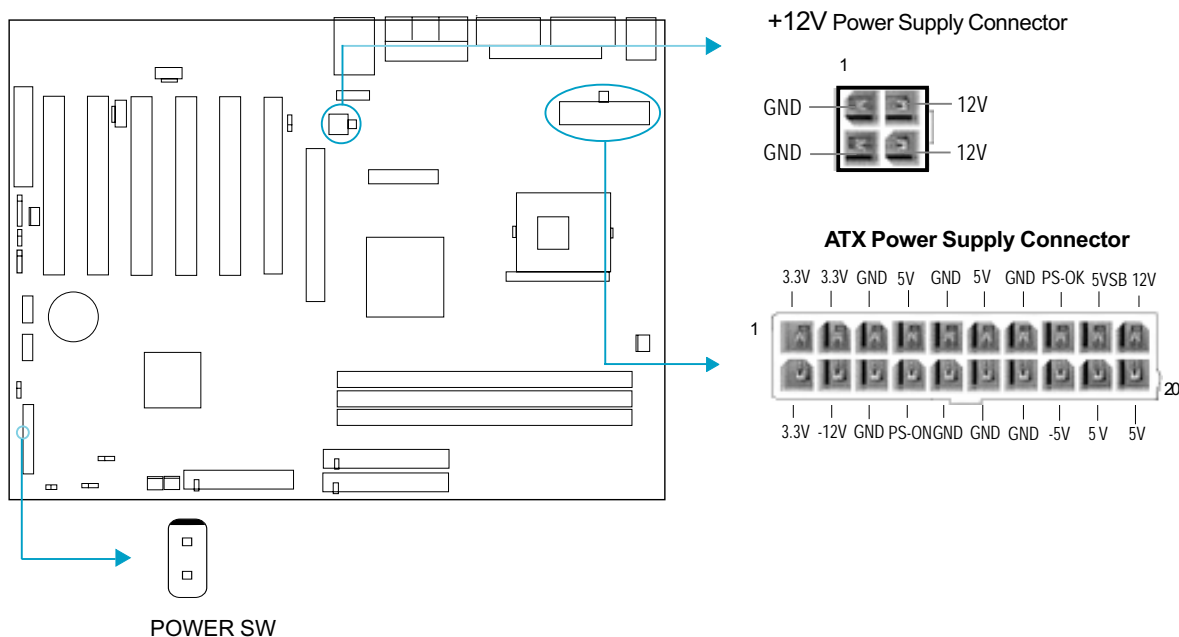

**Note:**

---

*If you change "Soft-off by PWR-BTTN" from default "Instant-off" to "Delay 4 Sec" in the "POWER MANAGEMENT SETUP" section of the BIOS, the power switch should be pressed for more than 4 seconds before the system powers down.*

---





### Hard Disk LED Connector (HD\_LED)

The connector connects to the case's IDE indicator LED indicating the activity status of IDE hard disk. The connector has an orientation. If one way doesn't work, try the other way.

### Reset Switch (RESET)

The connector connects to the case's reset switch. Press the switch once, the system resets.

### Speaker Connector (SPEAKER)

The connector can be connected to the speaker on the case.

### Power LED Connector (PWR\_LED)

When the system is in S0 status, the LED is on. When the system is in S1 status, the LED is blink; When the system is in S3,S4, S5 status, the LED is off. The connector has an orientation.

### GREEN LED Connector (GREEN\_LED)

When the system is in S0,S1,S4 ,S5 status, the LED is off,When the system is in S3 status, the LED is on.

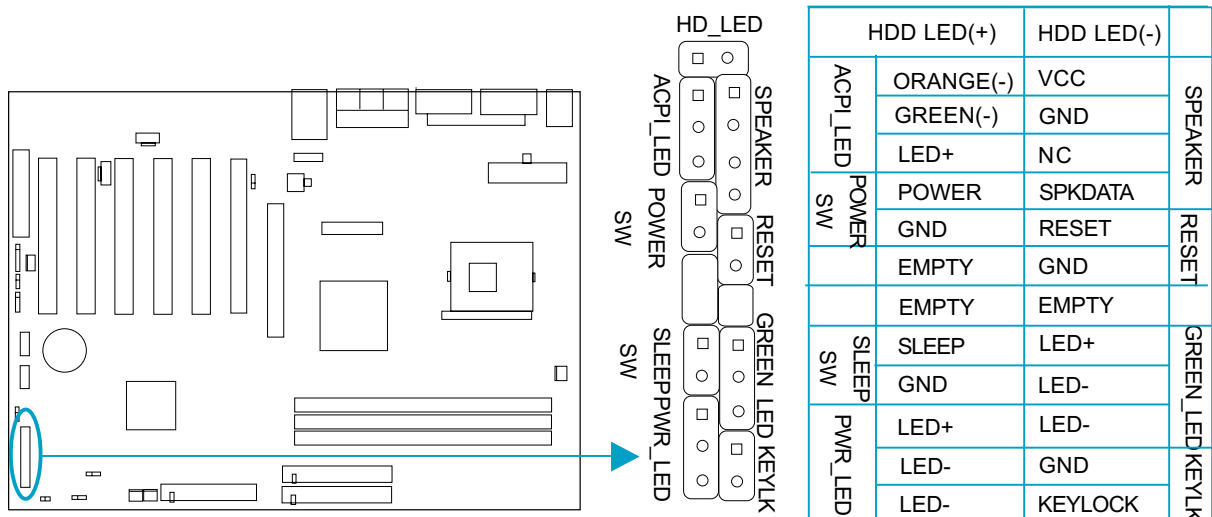



### ACPI LED Connector (ACPI\_LED)

The ACPI LED is a dual-color light with three pins. Pin1 and Pin2 drive different color lights. If Pin1 drives the orange light, then, Pin2 drives the green light, the following status will come out. When the system is in S0 status, the LED is green on. When the system is in S1 status, the LED is green blink. When the system is in S3 status, the LED is orange on. When the system is in S4, S5 status, the LED is off.

### Hardware Green Connector (SLEEP SW)

Push once the switch connected to this header, the system enters suspend mode.

### USB3,4 ;USB5,6

Besides USB1,2 on the back panel, the series of mainboards also have two 10-pin headers on board which may connect to front panel USB cable( optional ) to provide additional four USB ports.

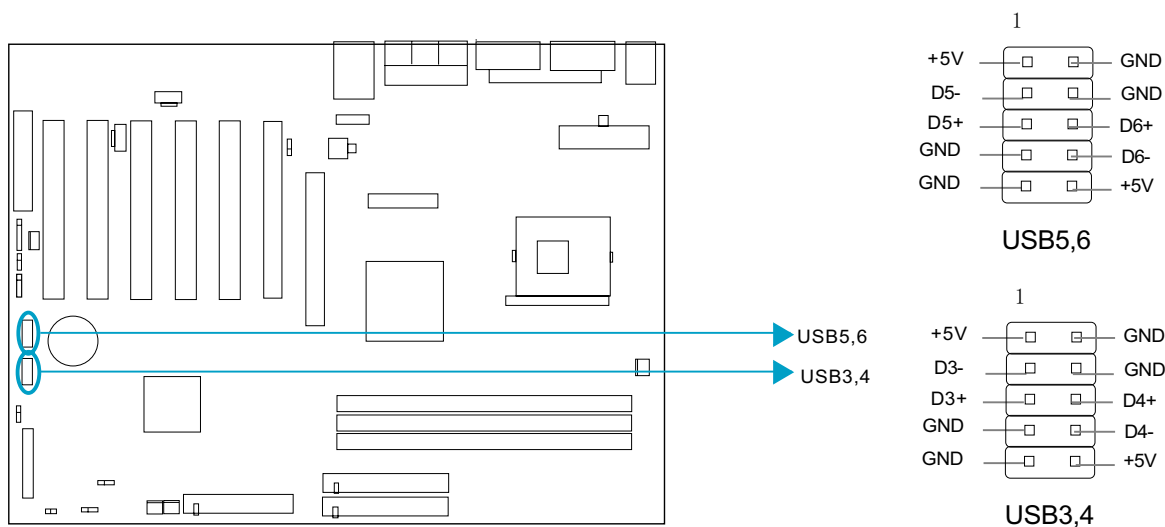

### Fan Connectors (BAKFAN, CPUFAN, CHSFAN)

The fan speed of CPUFAN and CHSFAN can be detected and viewed in “PC Health” section of the CMOS SETUP. These fans will be automatically turned off after the system enters suspend mode.

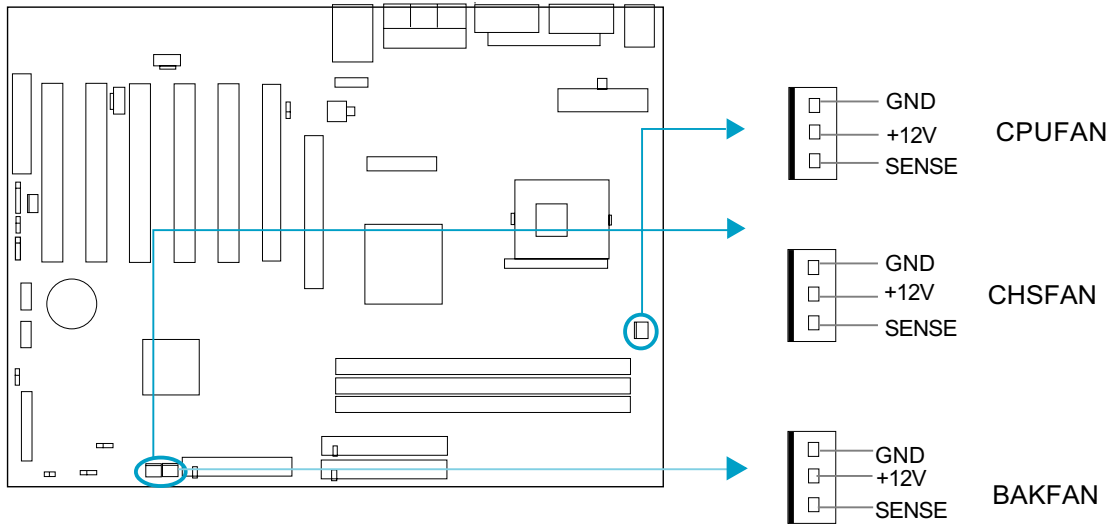

### Infrared Header (IrDA)

This connector supports wireless transmitting and receiving device. Before using this function, configure the settings for IR Address, IR Mode and IR IRQ from the “INTEGRATED PERIPHERALS” section of the CMOS SETUP.

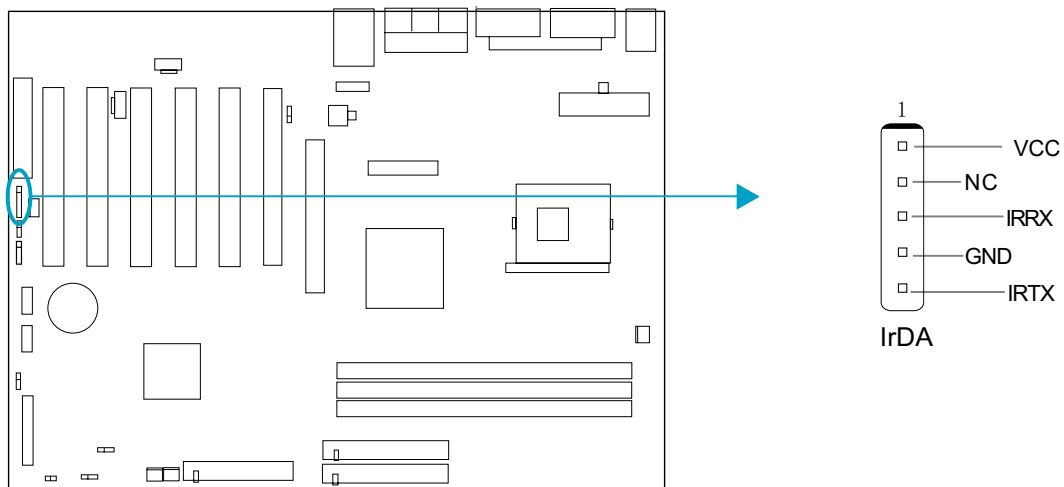



### Wake-Up On LAN (WOL)

Through the Wake-Up On LAN function, a wake event occurring from the network can wake up the system. If this function is to be used, please be sure an ATX12V power supply of which 5VSB line is capable of delivering current at least 720mA, and a LAN adapter which supports this function is used. Then connect this header to the relevant connector on the LAN adapter, set “Ring power up control” as Enabled in the “POWER MANAGEMENT SETUP” section of the CMOS SETUP. Save and exit, then boot the operating system once to make sure this function takes effect.

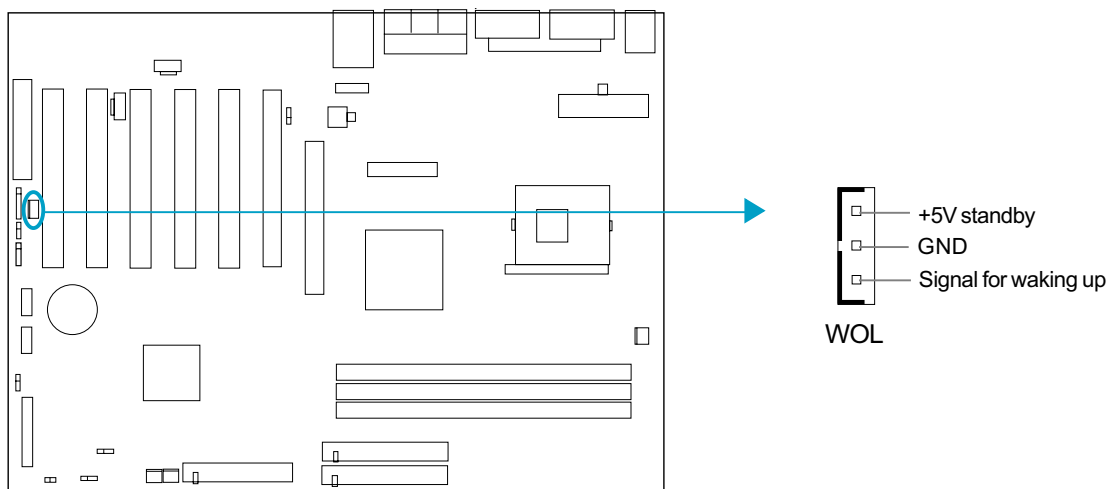

### Wake-Up On Internal Modem (WOM)

Through this function, the system which is in the suspend or soft-off status can be waked up by a ring signal received from the internal modem. When this function is used, be sure an internal modem card which supports this function is used. Then connect this header to the relevant connector on the modem card, set “Ring power up control” as Enabled in the “Power Management Setup” section of the CMOS SETUP. Save and exit, then boot the operating system once to make sure this function takes effect.

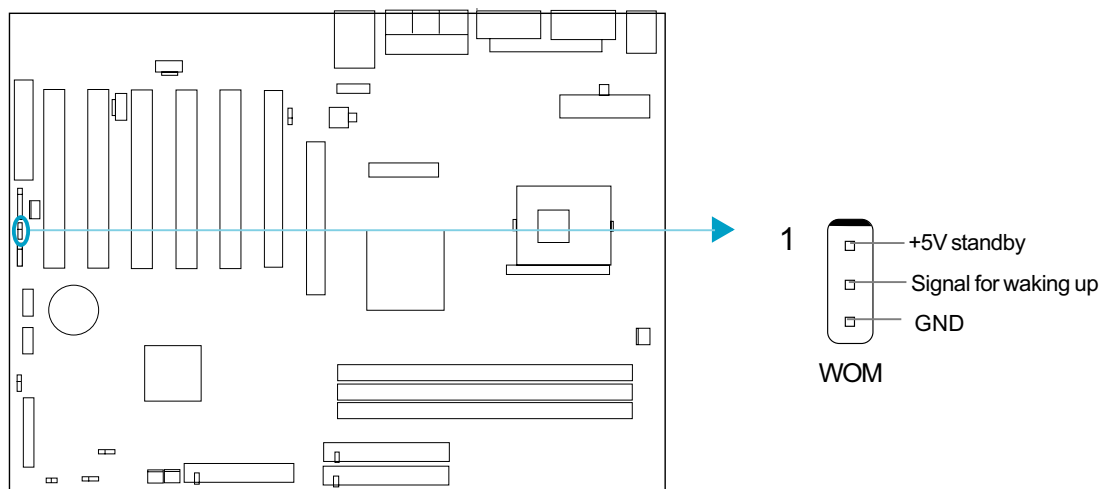

### Audio Connectors (CD\_IN, MODEM)

(available on -A, -AL)

CD\_IN is Sony standard CD audio connectors, it can be connected to a CD-ROM drive through a CD audio cable. The MODEM connector allows the onboard audio to interface with a voice modem card with a similar connector. It allows connecting the mono\_in (such as a phone) or mono\_out (such as a speaker) between the onboard audio and the voice modem card.

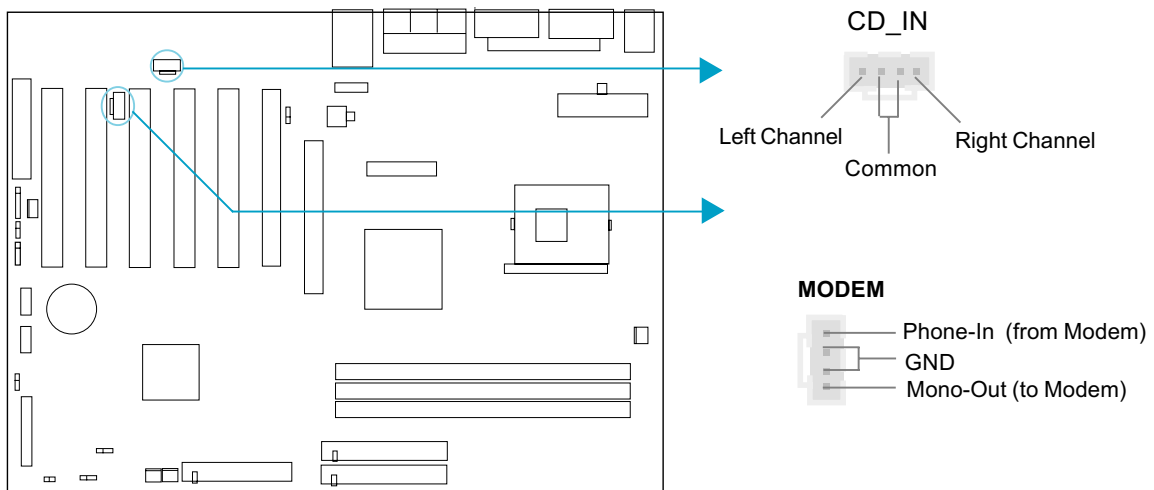

### 4-pin SMBus Connector(SMBUS)

This connector allows you to connect SMBus devices. SMBus devices communicate through the SMBus with a SMBus host and/or other SMBus devices. The SMBus or System Management Bus is a specific implementation of I<sup>2</sup>C bus, which is a multi-master bus, that is, multiple devices can be connected to the same bus and each one can act as a master by initiating data transfer.

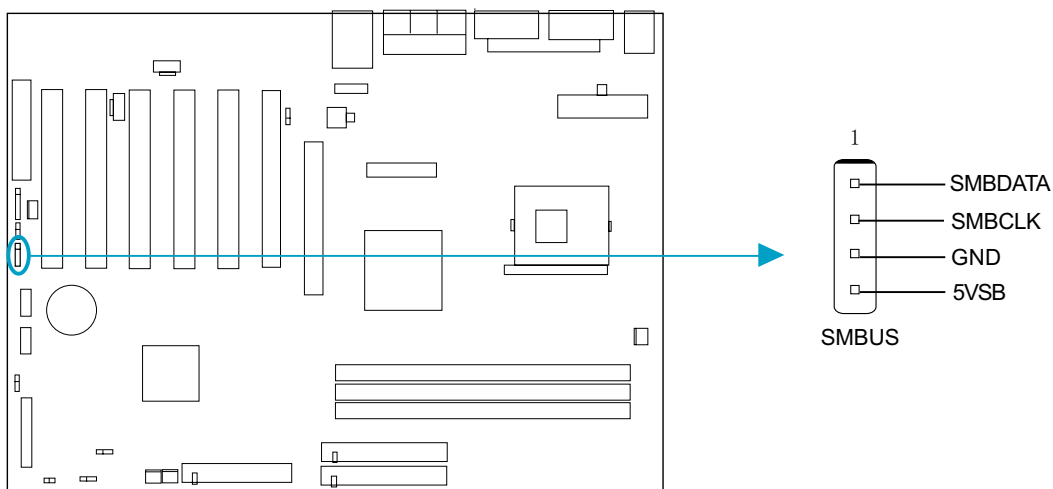



### Audio Interface(Optional)

The audio interface provides three kinds of audio output choices: the FrontAudio, the RearAudio and the ActiveAudio. Their priority level is as sequence. When the FrontAudio is available, the RearAudio and the ActiveAudio( in-case speakers ) will be cut off. When the RearAudio is available, the ActiveAudio will be cut off. An onboard amplifier is provided for the earphone. When the FrontAudio is absent, Pin11 and Pin12, Pin13 and Pin14 must be short connected.

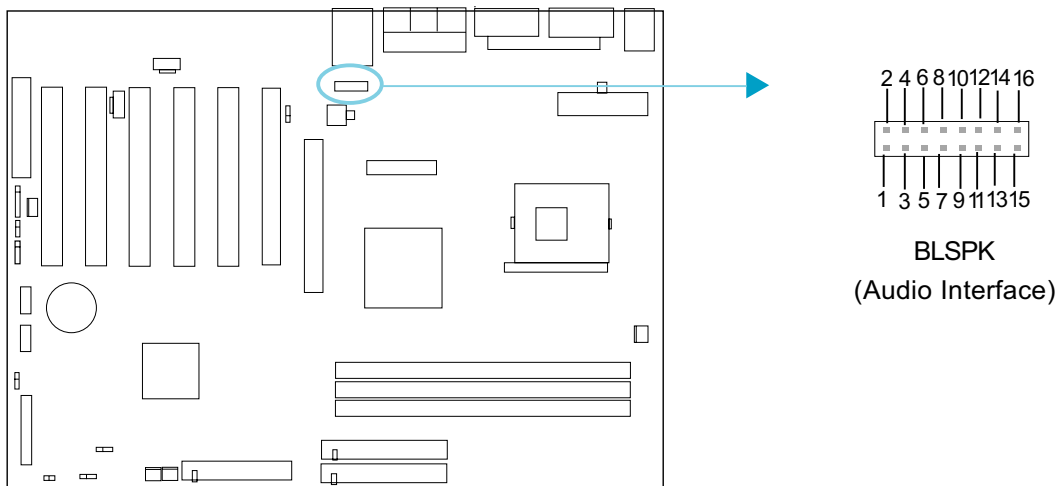
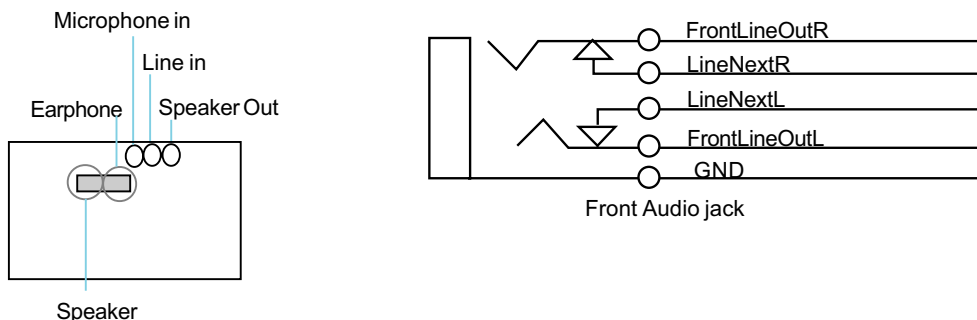

Pin No.	Symbol	Pin No.	Symbol
1	Active Line Out(R)	2	Active Line Out(L)
3	GND(ALO)	4	GND(ALO)
5	GND(+12)	6	GND(+12)
7	+12V(1A)	8	(Cut away)
9	MIC	10	GND(MIC)
11	Front Line Out(R)	12	Line Next(R)
13	Front Line Out(L)	14	Line Next(L)
15	GND(FLO)	16	(Cut away)



### Communication and Networking Riser Slot(CNR)

The mainboard provides Communication and Networking Riser(CNR) interface which can support audio and/or modem functions . Furthermore, it provides a LAN interface for networking functions. What its superiority compared with AMR is being able to support plug-and-play function. Mechanically the CNR shares a PCI slot, thus if a CNR card is not used,users can an additional PCI slot which shares the same position on back panel with CNR. By using an audio codec, the AC'97 digital link on CNR provides for cost-effective, high-quality, integrated audio on the platform.

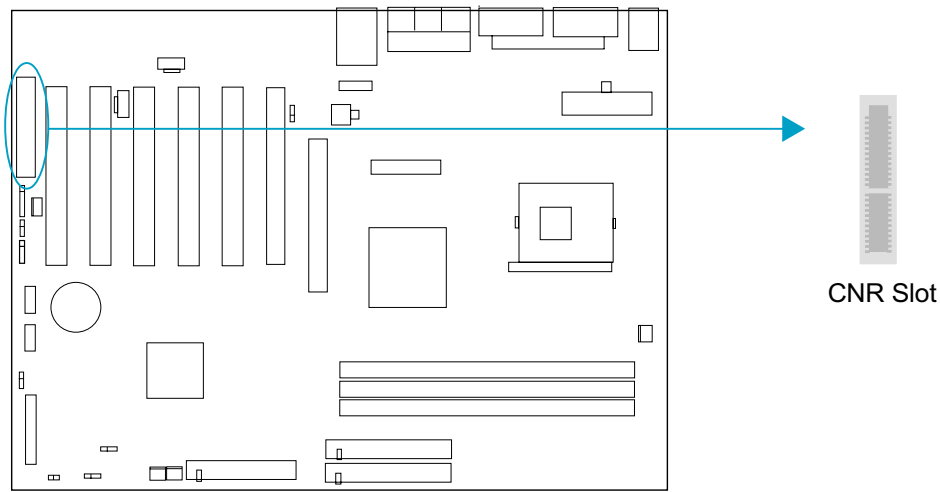





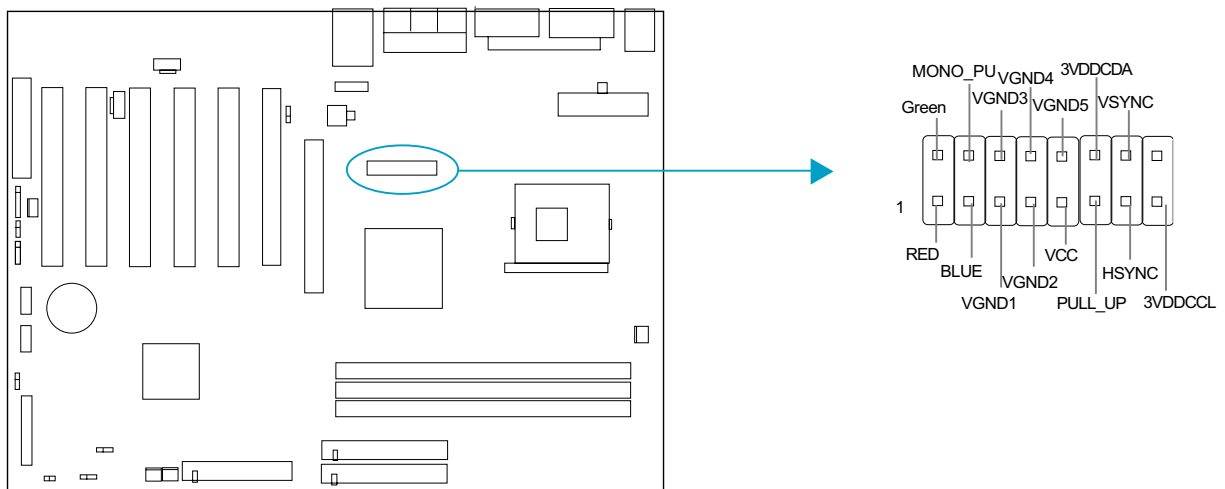



### Onboard VGA Connector (JVIDEO)

The mainboard provides onboard VGA connector which may connect to one VGA cable.



## Jumper Settings

Jumpers are located on the mainboard, the yare, clear CMOS jumper JCC, enable keyboard password power-on function jumper JKB, and enable/disable onboard audio jumper JSD etc. Pin 1 for all jumpers are located on the side with a thick white line (Pin1--  ), referring to the mainboard's silkscreen. Jumpers with three pins will be shown as  to represent pin1 & pin2 ("1-2") closed and  to represent pin2 & pin3 ("2-3") closed.

Jumper	Symbol	Description	Represent
		1-2	set pin1 and pin2 closed
		2-3	set pin2 and pin3 closed
		close	set the pins closed
		open	set the pins opened

### Enable Front/Back Panel USB Device Wake-up Function (JUSB1/JUSB2)

The mainboard provides the advanced USB device wake-up function. The system can be waked up from its power saving status including ACPI S3 by activating USB device. Before using this function, set JUSB1/JUSB2 with pin1 & pin2 closed. Otherwise, set JUSB1/JUSB2 with pin2 & pin3 closed for disabling. Furthermore, the item in CMOS Setup should also be set correspondingly to enable or disable this function.

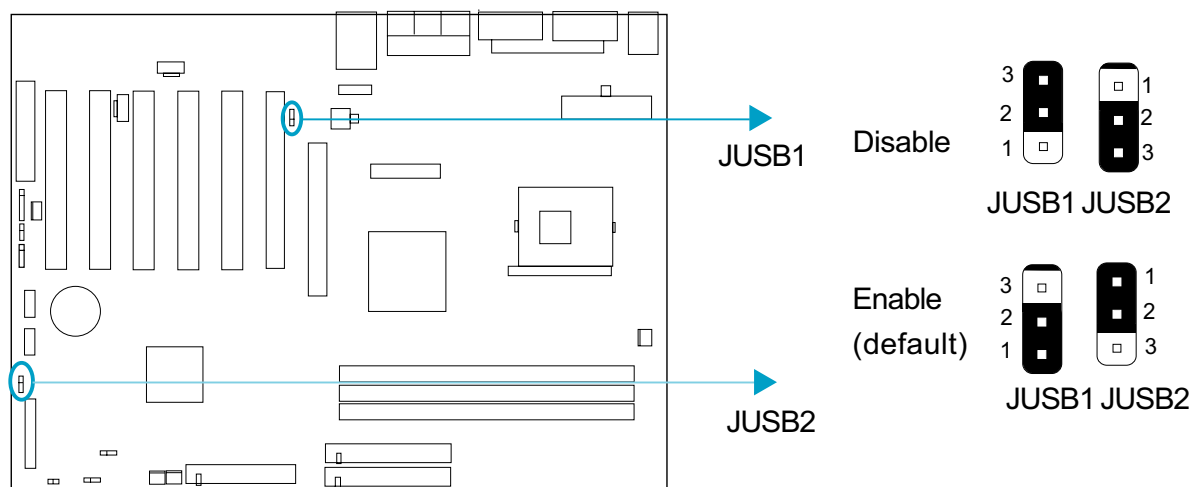



### Clear CMOS (JCC)

If you want to clear CMOS, unplug the AC power supply first, close JCC (pin1 & pin2) once, set JCC back to the normal status with pin2 & pin3 connected, then power on the system.

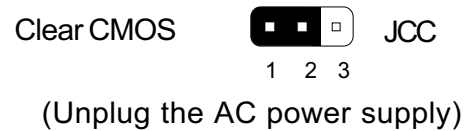
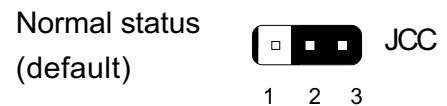
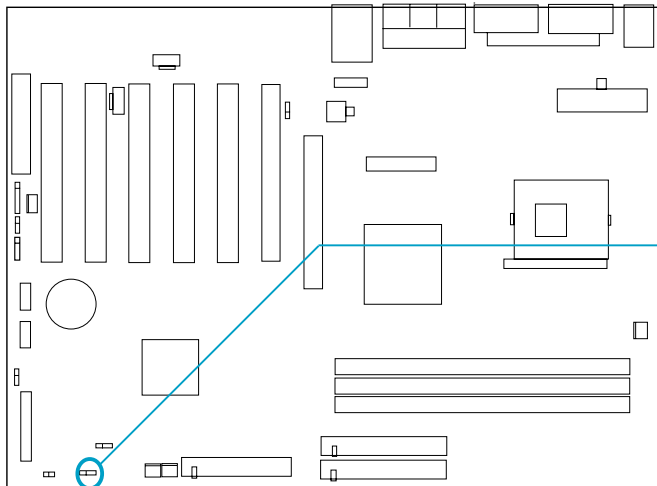

### Enable/Disable onboard audio (JSD)

( available on -A, -AL)

If you want to use the on-board audio, set JSD with pin2 & pin3 closed (default), Otherwise, set JSD with pin1 & pin2 closed for disabling this function.

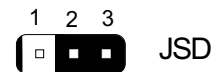
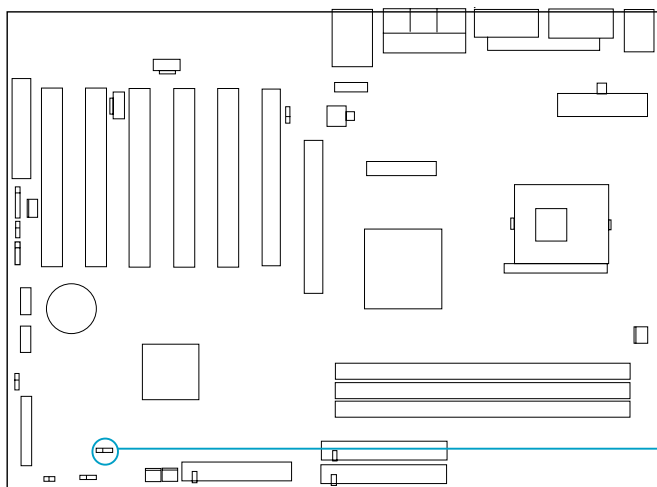

Disable on-board audio:  
Enable Primary CNR audio

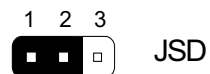

Enable onboard audio:  
Enable slave CNR audio only  
(Default)





## BIOS-Protection Jumper (JAV)

The BIOS of the mainboard is inside the FWH. If the jumper JAV is set as closed, the system BIOS is protected from being attacked by serious virus such as CIH virus, you will be unable to flash the BIOS to the mainboard. However in this status .

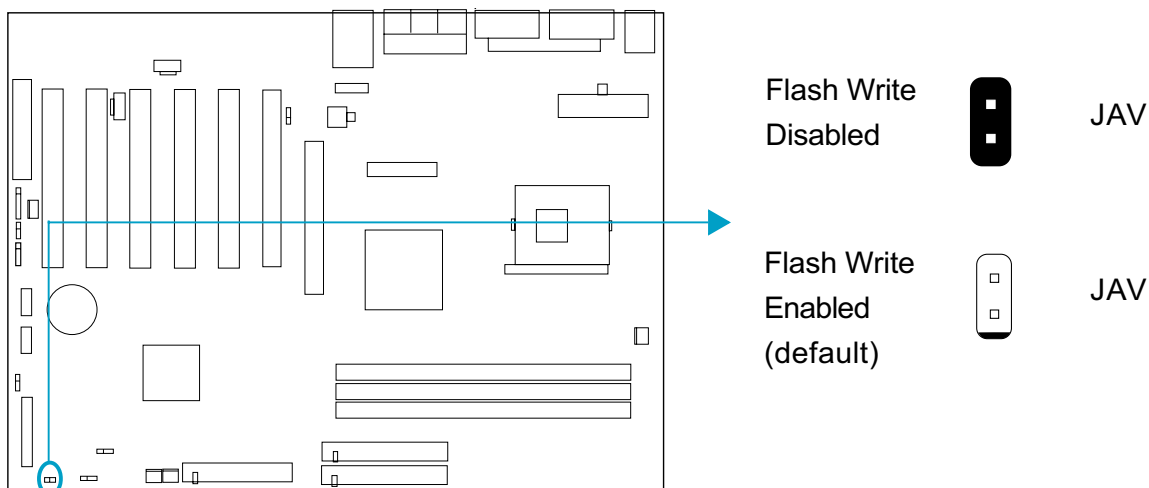

Setting the jumper JAV as open(default), meanwhile disabling the “Flash Write Protect” item in QDI Innovation features, allows you to flash the BIOS to the Flash ROM.

The DMI (Desktop Management Interface) system information such as the CPU type/speed, memory size, and expansion cards will be detected by the onboard BIOS and stored in the flash ROM. Whenever the system hardware configuration is changed, DMI information will be updated automatically. However, setting jumper JAV as closed makes flashing BIOS and updating DMI information impossible. Therefore, set JAV as open when changing the system hardware configuration, or the error message “Unknown Flash Type” will be displayed on the screen, and DMI information may not be updated. Under special conditions, the jumper “JAV” should be set as OPEN. For further details, refer to the “BootEasy” part of appendix.





## Chapter 3



---

### BIOS Description

---

The mainboard uses AWARD ® BIOS Setup program that provides a Setup utility for users to modify the basic system configuration. The information is stored in a battery-backed CMOS RAM so it retains the Setup information when the power is turned off.

This chapter provides you with the overview of the BIOS Setup.

---



## Utility Support

### AWDFLASH.EXE

This is a flash memory write/read utility used for the purpose of upgrading your BIOS when necessary. Before doing so, please note:

- We strongly recommend you only upgrade BIOS when encounter problems.
- Before upgrading your BIOS, review the description below to avoid making mistakes, destroying the BIOS and resulting in a non-working system.

When you encounter problems, for example, you find your system does not support the latest CPU released on our current mainboard, you may therefore upgrade the BIOS, please don't forget to set BIOS\_WP as open and disable the "Flash Write Protect" item in AWARD BIOS CMOS Setup first.

#### **Follow the steps exactly for a successful upgrade.**

1. Create a bootable system floppy diskette by typing Format A:/s from the DOS prompt under DOS6.xx or Windows 9x environment.
2. Copy AWDFLASH.EXE (version $\geq$ 8.03) from the directory \Utility located on QDI Mainboard Utility CD onto your new bootable diskette.
3. Download the updated BIOS file from the Website (<http://www.qdigrp.com>). Please be sure to download the suitable BIOS file for your mainboard.
4. Decompress the file downloaded, copy the BIOS file (xx.bin) onto the bootable diskette, and note the checksum of this BIOS which is located in readme file.
5. Reboot the system from the bootable diskette created.
6. Then run the AWDFLASH utility at the **A:\** prompt as shown below:  
A:\AWDFLASH xxxx.bin

If you require more detailed information concerning AWDFLASH Utility, for example, the different usage of parameters, please type A:\>AWDFLASH /?



#### **Note:**

1. Follow the instruction through the process. Don't turn off power or reset the system until the BIOS upgrade has been completed.
2. AWDFLASH.EXE (version $\geq$ 8.03) utility must be used to upgrade the mainboard family BIOS instead of QDI flash utility.
3. BIOS version will update constantly. We will not be responsible for any BIOS description differ from your mainboard BIOS shown.



## AWARD(Phoenix) BIOS Description

### Entering Setup

Power on the computer, when the following message briefly appears at the bottom of the screen during the POST (Power On Self Test), press <Del> key to enter the AWARD BIOS CMOS Setup Utility.

#### Press <Del> to enter SETUP

Once you have entered, the Main Menu (Figure 1) appears on the screen. The main menu allows you to select from eleven setup functions and two exit choices. Use the arrow keys to select among the items and press the <Enter> key to accept or enter the sub-menu.



Figure-1 Main Menu

### Load Optimized Defaults

The Optimized Defaults are common and efficient. It is recommended users load the optimized defaults first, then modify the needed configuration settings.

### Standard CMOS Features Setup

The basic CMOS settings included in “Standard CMOS Features” are Date, Time, Hard Disk Drive Types, Floppy Disk Drive Types, and VGA etc. Use the arrow keys to highlight the item, then use the <PgUp> or <PgDn> keys to select the value desired in each item.



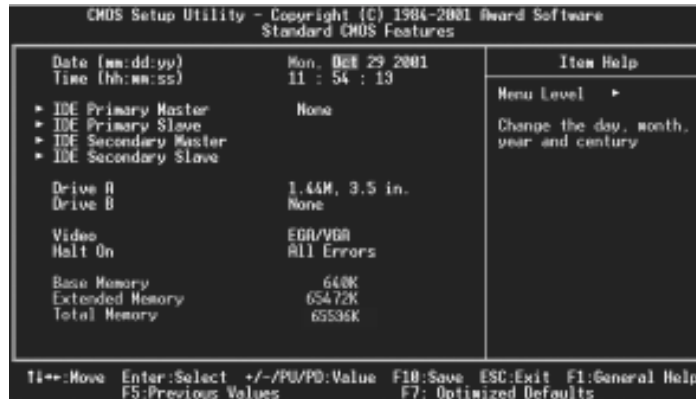

Figure-2 Standard CMOS Setup Menu

For the items marked, press enter, a window will pop up as shown below. You can view detailed information or make modifications.

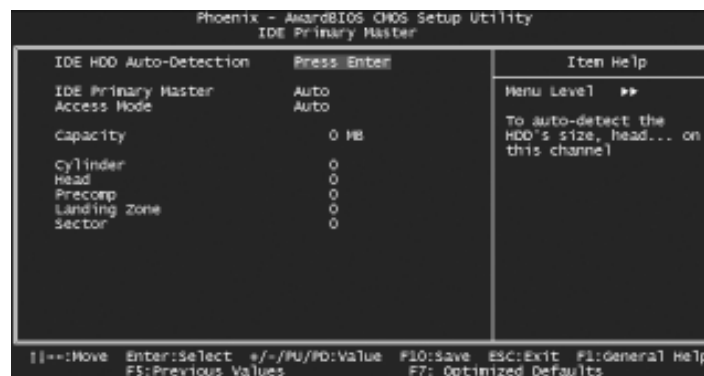

Figure-2-1 IDE Primary Master Setup Menu

### Hard Disk

#### Primary Master/Primary Slave/Secondary Master/Secondary Slave

These categories identify the HDD types of 2 IDE channels installed in the computer system. There are three choices provided for the Enhanced IDE BIOS: None, Auto, and Manual. 'None' means no HDD is installed or set; 'Auto' means the system can auto-detect the hard disk when booting up; by choosing 'Manual', the related information should be entered regarding the following items. Enter the information directly from the keyboard and press < Enter>:

CYLS	number of cylinders	HEAD	number of heads
PRECOMP	write pre-compensation	LANDZ	landing zone
SECTOR	number of sectors	MODE	HDD access mode



The Award BIOS supports 3 HDD modes: NORMAL, LBA and LARGE.

### **CHS mode**

Generic access mode in which neither the BIOS nor the IDE controller will make any transformation during accessing. The maximum number of cylinders, heads and sectors for CHS mode are 1024,16 and 63.

If the user sets his HDD to NORMAL mode, the maximum accessible HDD size will be 528 megabytes even though its physical size may be greater than that.

### **LBA (Logical Block Addressing) mode**

A new HDD accessing method to overcome the 528 Megabyte bottleneck. The number of cylinders, heads and sectors shown in setup may not be the number physically contained in the HDD.

During HDD accessing, the IDE controller will transform the logical address described by sector, head and cylinder number into its own physical address inside the HDD.

### **Large mode**

Some IDE HDDs contain more than 1024 cylinder without LBA support (in some cases, users do not want LBA). The Award BIOS provides another alternative to support these kinds of HDD.

BIOS tricks DOS (or other OS) into dividing the number of cylinders is less than 1024 by dividing it by 2. At the same time, the number of heads is multiplied by 2. A reverse transformation process will be made inside INT13h in order to access the right HDD address.

If using Auto detect, the BIOS will automatically detect the IDE hard disk mode and set it as one of the three modes.

### **Remark**

To support LBA or LARGE mode of HDDs, there must be some softwares involved which are located in Award HDD Service Routine(INT13h).It may fail to access a HDD with LBA (LARGE) mode selected if you are running under an Operating System which replaces the whole INT 13h.





**Video**

Set this field to the type of video display card installed in your system.

EGA/VGA	Enhanced Graphics Adapter / Video Graphic Array. For EGA, VGA, SEGA, SVGA, or PGA monitor adapters.
CGA 40	Color Graphic Adapter, powering up in 40 column mode.
CGA 80	Color Graphic Adapter, powering up in 80 column mode.
MONO	Monochrome adapter, including high resolution monochrome adapters.

**Halt On**

This category determines whether or not the computer will stop if an error is detected during powering up.

No errors	The system boot will not stop for any errors that may be detected.
All errors	Whenever the BIOS detects a non-fatal error, the system will stop and you will be prompted.
All, But Keyboard	The system boot will not stop for a keyboard error; but it will stop for all other errors.
All, But Diskette	The system boot will not stop for a disk error; but it will stop for all other errors.
All, But Disk/Key	The system boot will not stop for a keyboard or disk error, but it will stop for all other errors.

**Memory**

This is a Display-Only Category, determined by POST (Power On Self Test) of the BIOS.

Base Memory	The POST of the BIOS will determine the amount of base (or conventional) memory installed in the system.
Extended Memory	The BIOS determines how much extended memory is presented during the POST.
Total Memory	Total memory of the system .





QDI Innovation features

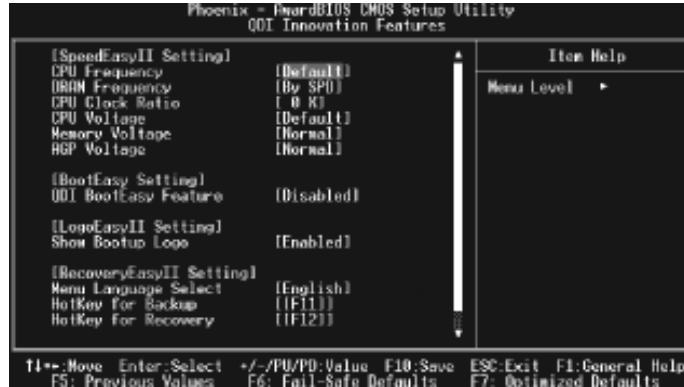

Figure-3 QDI Innovation features Menu

The following indicates the options for each item and describes their meaning.

Item	Option	Description
<b>[SpeedEasyII setting]</b>		
• CPU Frequency	<i>default</i> <i>100/133MHz</i>	Set CPU frequency.
• DRAM Frequency	<i>By SPD</i> <i>200/266</i> <i>333MHz</i>	Set DRAM frequency by SPD. Set DRAM frequency manually.
• CPU Clock Ratio	<i>Min=8</i> <i>Max=50</i>  <i>Key in a</i> <i>DEC number</i>	Select the multiplication of processor core frequency. If a Ratio -locked processor installed, this item will be hidden. This item is only for users who understand all the CPU parameters. This function will not take effect for bus ratio locked processor. Fill in a DEC number of the ratio you want .
• CPU Voltage	<i>Default</i> <i>- 0.075V</i> <i>...+ 0.100V</i>	Set CPU Voltage.
• Memory Voltage	<i>Normal</i> <i>+10%</i>	DDR Voltage is normal. DDR Voltage exceeds Normal by ten percent.



Item	Option	Description
<ul style="list-style-type: none"> <li>AGP Voltage</li> </ul>	<p><i>Normal</i> <i>+10%</i></p>	<p>AGP Voltage is normal. AGP Voltage exceeds Normal by ten percent.</p>
<b>[BootEasy setting]</b>		
<ul style="list-style-type: none"> <li>QDI BootEasy feature</li> </ul>	<p><i>Enabled</i> <i>Disabled</i></p>	<p>PC boot in rapid speed, without any redundant feature waiting for the displaying of starting OS. PC boot in the legacy BIOS way.</p>
<b>[LogoEasyII setting]</b>		
<ul style="list-style-type: none"> <li>Show Bootup Logo</li> </ul>	<p><i>Enabled</i> <i>Disabled</i></p>	<p>The logo will be shown automatically when system boots up, otherwise, no logo appears on the screen.</p>
<b>[RecoveryEasyII setting]</b>		
<ul style="list-style-type: none"> <li>Menu language Select</li> </ul>	<p><i>English</i> <i>Chinese</i></p>	<p>Select RecoveryEasyII Interface Menu language.</p>
<ul style="list-style-type: none"> <li>Hotkey for Backup/Recovery</li> </ul>	<p><i>NULL</i> <i>F2~F12</i></p>	<p>Backup/Recovery interface can not be used by Pressing Hotkey. Select Hotkey to enter Backup/Recovery interface during POST.</p>
<b>[BIOS -protectEasy setting]</b>		
<ul style="list-style-type: none"> <li>Flash Write Protect</li> </ul>	<p><i>Enabled</i> <i>Disabled</i></p>	<p>This option is for protecting the system BIOS, when enabled, writing to BIOS area is to be discarded.</p>



**Warning:**

---

*Be sure your selection is right. CPU over speed will be dangerous! We will not be responsible for any damages caused.*

---



## Advanced BIOS Features Setup



Figure-4 Advanced BIOS Features Menu

The following indicates the options for each item and describes their meaning.

Item	Option	Description
● Virus warning	<i>Enabled</i>	Allows you to choose the VIRUS warning feature for IDE Hard Disk boot sector protection. If this function is enabled and someone attempt to write data into this area, BIOS will show a warning message on screen and alarm beep.
	<i>Disabled</i>	Invalidates this function.
● CPU L1&L2 Cache	<i>Enabled</i>	Enable CPU L1/L2 cache.
	<i>Disabled</i>	Disable CPU L1/L2 cache.
● CPU L2 Cache ECC Checking	<i>Enabled</i>	Enables CPU L2 Cache ECC function.
	<i>Disabled</i>	Disables CPU L2 Cache ECC function.
● Quick Power On Self Test	<i>Enabled</i>	Allow the system to skip certain tests while booting. This will decrease the time needed to boot the system.
	<i>Disabled</i>	Normal POST.
● First (Second, Third) Boot Device Boot Other Device .....	<i>Disabled</i>	Select Your Boot Device Priority. It could be Disabled, Floppy, LS120, ZIP100, HDD-0, HDD-1, HDD-2, HDD-3, SCSI, CDROM, LAN.
	<i>Floppy</i>	
	<i>CDROM</i>	



<u>Item</u>	<u>Option</u>	<u>Description</u>
• Swap Floppy Drive	<i>Enabled</i> <i>Disabled</i>	If the system has two floppy drives, choose enable to assign physical drive B to logical drive.
• Boot Up Floppy Seek	<i>Enabled</i> <i>Disabled</i>	Tests floppy drives to determine whether they have 40 or 80 tracks.
• Boot Up NumLock Status	<i>On</i> <i>Off</i>	Select power on state for NumLock.
• Gate A20 Option	<i>Normal</i> <i>Fast</i>	Let chipset control GateA20 and Normal - a pin in the keyboard controller controls GateA20.
• Typematic Rate Setting	<i>Enabled</i> <i>Disabled</i>	Keystrokes repeat at a rate determined by the keyboard controller - when enabled, the typematic rate and typematic delay can be selected.
• Typematic Rate (chars/sec)	6~30	The rate at which character repeats when you hold down a key.
• Typematic Delay (Msec)	250~1000	The delay before keystrokes begin to repeat.
• Security Option	<i>Setup</i> <i>System</i>	Select whether the password is required every time the system boot or only when you enter setup.
• APIC mode	<i>Enabled</i> <i>Disabled</i>	Enable the APIC mode(Advanced Programmable Interrupt Controller). Disable the APIC mode.
• MPS Version control for OS	1.1 1.4	Set the MPS Version Control for OS.
• OS Select For DRAM>64MB	<i>Non-OS2</i> <i>OS2</i>	Select OS2 only if you are running OS/2 operating system with more than 64MB of RAM.
• HDD S.M.A.R.T. Capability	<i>Enabled</i> <i>Disabled</i>	Enable hard disk S.M.A.R.T. support. Invalidate this feature.



<u>Item</u>	<u>Option</u>	<u>Description</u>
• Report no FDD for WIN 95	<i>Yes</i>	Report NO Floppy Disk Drive for WIN 95 to release IRQ6.
	<i>No</i>	Do not report No Floppy Disk Drive for WIN 95.
• Video BIOS Shadow	<i>Enabled</i>	Video BIOS will be copied to RAM. Video Shadow will increase the video speed.
	<i>Disabled</i>	Invalidates this feature.
• Small Logo EPA show	<i>Enabled</i>	The EPA logo will be shown automatically when system boots up, otherwise, no logo appears on the screen.
	<i>Disabled</i>	



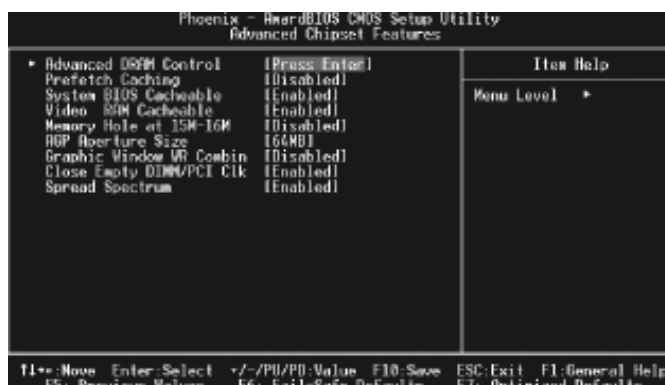

Figure-5 Advanced Chipset Features Menu

The following indicates the options for each item and describes their meaning.

<u>Item</u>	<u>Option</u>	<u>Description</u>
• Advanced DRAM Control	<i>Press Enter</i>	Press enter to set the items about DRAM.
• DRAM Timing control	<i>by SPD Manual</i>	Sets DDR Timing.
• CAS Latency Setting	<i>2T/2.5T/3T</i>	Define CAS latency time.
• DRAM Addr/Cmd Rate	<i>AUTO 1T/2T</i>	DRAM address and command delay time setting.
• Prefetch Caching	<i>Enable Disable</i>	Enable precharge caching. Invalidates this function.
• System BIOS Cacheable	<i>Enabled Disabled</i>	Besides conventional memory, system BIOS area is also cacheabl Video BIOS area is not cacheable.
• Video RAM Cacheable	<i>Enabled Disabled</i>	Besides conventional memory, video RAM area is also cacheable. Video RAM area is not cacheable.



<b>Item</b>	<b>Option</b>	<b>Description</b>
• Memory hole at 15M-16M	<i>Enabled</i> <i>Disabled</i>	Memory hole at 15-16M is reserved for expanded ISA card. Do not set this memory hole.
• AGP Aperture Size (MB)	<i>4/8/16/32</i> <i>64/128/256</i>	Set the effective size of the Graphics Aperture to be used in the particular GART Configuration.
• Graphic Window WR combin	<i>Enabled</i> <i>Disabled</i>	Set Graphic Window to improve 3D performance. Invalidates this function.
• Close Empty DIMM/PCI Clk	<i>Enabled</i> <i>Disabled</i>	Close empty DIMM or PCI clock to reduce EMI. Do not close empty DIMM or PCI clock.
• Spread Spectrum	<i>Enabled</i> <i>Disabled</i>	Enable Clock Spread Spectrum to reduce EMI. Disable Clock Spread Spectrum.



## Power Management Setup

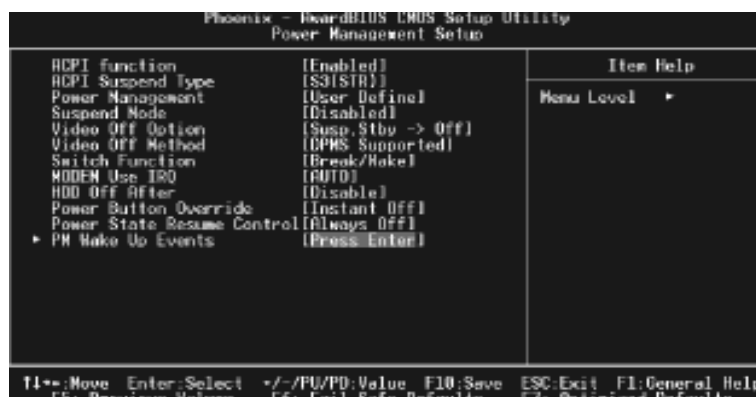

Figure-6 Power Management Setup Menu

The following indicates the options for each item and describes their meaning.

<u>Item</u>	<u>Option</u>	<u>Description</u>
● ACPI function	<i>Enabled</i> <i>Disabled</i>	Enable ACPI function. Disable this function.
● ACPI Suspend Type	<i>S1(POS)</i> <i>S3(STR)</i> <i>S1&amp;S3</i>	Select the ACPI suspend type.
● Power Management	<i>User Define</i> <i>Min Saving</i> <i>Max Saving</i>	Users can configure their own Power Management Timer. Pre - defined timer values are used. All timers are in their MAX values. Pre - defined timer values are used. All timers are in their MIN values.
● Suspend Mode	<i>Disabled</i> <i>1Min ~1Hour</i>	The system never enter Suspend mode by timer. Define the continuous idle time before the system enters Suspend mode. If any items defined in “PM Events” are on and activated, the system will be woken up.





Item	Option	Description
<ul style="list-style-type: none"> <li>Video Off Option</li> </ul>	<ul style="list-style-type: none"> <li><i>Suspend-&gt;Off</i></li> <li><i>Always On</i></li> </ul>	<ul style="list-style-type: none"> <li>Screen blanks after the system enters either standby mode or suspend mode.</li> <li>Screen is always on.</li> </ul>
<ul style="list-style-type: none"> <li>Video Off Method</li> </ul>	<ul style="list-style-type: none"> <li><i>Blank Screen</i></li> <li><i>V/H SYNC + Blank</i></li> <li><i>DPMS</i></li> </ul>	<ul style="list-style-type: none"> <li>The system BIOS will only blank off the screen when disabling video.</li> <li>In addition to Blank Screen, BIOS will also turn off the V-SYNC &amp; H - SYNC signals from VGA card to monitor.</li> <li>This function is enabled only for VGA cards supporting DPMS.</li> <li><b>Note: When the green monitor does not detect the V/H-SYNC signals, the electron gun will be turned off.</b></li> </ul>
<ul style="list-style-type: none"> <li>Switch function</li> </ul>	<ul style="list-style-type: none"> <li><i>break/wake</i></li> <li><i>Disabled</i></li> </ul>	<ul style="list-style-type: none"> <li>Enable Power Switch to wake up.</li> <li>Disable Power Switch to wake up.</li> </ul>
<ul style="list-style-type: none"> <li>MODEM Use IRQ</li> </ul>	<ul style="list-style-type: none"> <li><i>3, 4, 5, 7, 9</i></li> <li><i>10, 11</i></li> <li><i>Auto</i></li> </ul>	<ul style="list-style-type: none"> <li>Special wake-up event for Modem.</li> </ul>
<ul style="list-style-type: none"> <li>HDD Off After</li> </ul>	<ul style="list-style-type: none"> <li><i>Disabled</i></li> <li><i>1 - 15 Min</i></li> </ul>	<ul style="list-style-type: none"> <li>HDD's motor will not turn off by timer.</li> <li>Define the continuous HDD idle time before the HDD enters power saving mode (motor off).</li> </ul>
<ul style="list-style-type: none"> <li>Power Button Override</li> </ul>	<ul style="list-style-type: none"> <li><i>Instant-Off</i></li> <li><i>Delay 4 sec.</i></li> </ul>	<ul style="list-style-type: none"> <li>The system will immediately power off once the power button is pressed.</li> <li>The system will power off when power button is pressed for more than 4 seconds.</li> </ul>
<ul style="list-style-type: none"> <li>Power State Resume Control</li> </ul>	<ul style="list-style-type: none"> <li><i>Always Off</i></li> <li><i>Always On</i></li> <li><i>keep pre-states</i></li> </ul>	<ul style="list-style-type: none"> <li>System is always off when put on AC power.</li> <li>System is on once put on AC power.</li> <li>Keep the preceding states.</li> </ul>
<ul style="list-style-type: none"> <li>PM Wake up Events</li> </ul>	<ul style="list-style-type: none"> <li><i>Press Enter</i></li> </ul>	<ul style="list-style-type: none"> <li>Enter to set the items about PM.</li> </ul>



<u>Item</u>	<u>Option</u>	<u>Description</u>
<ul style="list-style-type: none"> <li>● IRQ(3~7,9~15) NMI</li> </ul>	<i>Enabled</i>	Enables IRQ“X” to wake up.
	<i>Disabled</i>	Disables IRQ“X” to wake up.
<ul style="list-style-type: none"> <li>● IRQ 8 Break Suspend</li> </ul>	<i>Enabled</i>	Allows the system to be waken up by IRQ 8.
	<i>Disabled</i>	Does not allow the system to be waken up by IRQ8.
<ul style="list-style-type: none"> <li>● Ring power up control</li> </ul>	<i>Enabled</i>	Allow the system to be powered on when a Ring indicator signal comes up to UART1 or UART2 from external modem .
	<i>Disabled</i>	Do not allow Ring wake up.
<ul style="list-style-type: none"> <li>● MACPME Power Up Control</li> </ul>	<i>Enabled</i>	Allows the system to be waken up by onboard LAN.
	<i>Disabled</i>	Does not allow the system to be powered on by onboard LAN.
<ul style="list-style-type: none"> <li>● PCIPME Power Up Control</li> </ul>	<i>Enabled</i>	Allows the system to be waken up by PCI card.
	<i>Disabled</i>	Does not allow the system to be powered on by PCI card.
<ul style="list-style-type: none"> <li>● Power up by Alarm</li> </ul>	<i>Enabled</i>	RTC alarm can be used to generate a wake-up event to power up the system.
	<i>Disabled</i>	RTC has no alarm function.



## PNP/PCI Configuration Setup



Figure-7 PNP/PCI Configuration Setup Menu

The following indicates the options for each item and describes their meaning.

<u>Item</u>	<u>Option</u>	<u>Description</u>
• Reset Configuration Data	<i>Enabled</i>  <i>Disabled</i>	Default setting is Disabled. Select Enabled to re-set Extended System Configuration Data ESCD when you exit Setup, if you have installed a new add-on and the system reconfiguration has caused serious conflicts preventing the OS from booting. Disable the configuration data function.
• Resources Controlled By	<i>Auto(ESCD)</i> <i>Manual</i>	BIOS can automatically configure all boot and Plug and Play compatible devices. If you choose Auto, you cannot select IRQ DMA and memory base address fields, because BIOS automatically assigns them.
• PCI/VGA Palette Snoop	<i>Disabled</i> <i>Enabled</i>	Default setting. Non-standard VGA cards such as graphics accelerators or MPEG video cards may not show colors properly. Enabling this item can solve this problem.



## Integrated Peripherals

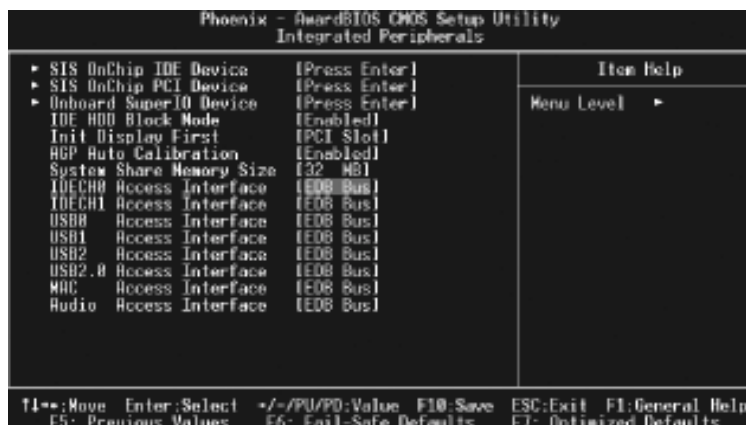

Figure-8 Integrated Peripherals Menu

The following indicates the options for each item and describes their meaning.

Item	Option	Description
SIS On-Chip IDE device	Press Enter	Press enter to set On-Chip IDE device.
Internal PCI/IDE	Disabled Primary Secondary Both	Set the ports of Onboard IDE.
IDE Primary Master/Slave PIO	Mode 0 - 4 Auto	Define the IDE primary master/ slave PIO mode. The IDE PIO mode is defined by auto -detection.
IDE Primary Master/Slave UDMA	Auto Disabled	Ultra DMA mode will be enabled if an Ultra DMA device is detected. Disable this function.
IDE Burst Mode	Enabled Disabled	Enables IDE Burst Mode. Disables IDE Burst Mode.
SIS On-Chip PCI device	Press Enter	Press enter to set On-Chip PCI device.
SIS USB Controller	Enabled Disabled	Enable onchip USB controller. Disable onchip USB controller.



<u>Item</u>	<u>Option</u>	<u>Description</u>
• USB Ports Number	3~6	Select the USB ports number.
• USB 2.0 Support	<i>Enabled</i> <i>Disabled</i>	Enable USB 2.0 to support. Disable USB 2.0 to support.
• USB Keyboard Support	<i>Enabled</i> <i>Disabled</i>	Support USB Keyboard under legacy OS. Disable this function.
• SIS S/W Modem	<i>Enabled</i> <i>Disabled</i>	Enable CNR AC97 Modem. Disable CNR AC97 Modem.
• SIS 10/100METHERNET	<i>Enabled</i> <i>Disable</i>	The onboard LAN is enabled. The onboard LAN is disabled.
• Onboard Super IO Device	<i>Press Enter</i>	Press enter to set Super IO device.
• Onboard FDC Controller	<i>Enabled</i> <i>Disabled</i>	Onboard floppy disk controller is enabled. Onboard floppy disk controller is disabled.
• Onboard Serial Port 1/2	<i>3F8/IRQ4,</i> <i>2F8/IRQ3,</i> <i>3E8/IRQ4,</i> <i>2E8/IRQ3,</i> <i>Auto</i>  <i>Disabled</i>	Define the onboard serial port address and required interrupt number.  Onboard serial port address and IRQ are automatically assigned. Onboard serial port is disabled.
• UART Mode Select	<i>Normal</i> <i>IrDA</i> <i>ASK IR</i>	Defines Serial Port as standard serial port. Supports IRDA mode. Supports SHARP ASK-IR protocol with maximum baud rate up to 57600bps.
• UR2 Duplex Mode	<i>Half /Full</i>	Default is recommended.
• Onboard Parallel Port	<i>378/IRQ7</i> <i>278/IRQ5</i> <i>3BC/IRQ7</i> <i>Disabled</i>	Define parallel port address and IRQ channel.  Onboard parallel port is disabled.

<u>Item</u>	<u>Option</u>	<u>Description</u>
● Parallel Port Mode	<i>SPP</i> <i>EPP</i> <i>ECP</i> <i>ECP+EPP</i>	Define the parallel port mode.
● ECP Mode Use DMA	3 1	Set ECP Mode Use DMA is 1 or 3.
● Game Port Address	<i>Disabled</i> 201,209	This option is used to configure Game Port Address.
● Midi Port Address	<i>Disabled</i> 290/300 330	This option is used to configure Midi Port Address.
● Midi Port IRQ	5/10	This option is used to configure Midi Port IRQ.
● IDE HDD Block Mode	<i>Enabled</i> <i>Disabled</i>	Allow IDE HDD to read/write several sectors at once. IDE HDD only reads/writes a sector once.
● Init Display First	<i>PCI Slot</i> <i>AGP</i>	Initialize the PCI VGA first. Initialize the AGP first.
● AGP Auto Calibration	<i>Enabled</i> <i>Disabled</i>	Enable the AGP auto calibration. Disable the AGP auto calibration.
● System share Memory Size	4~64MB	Set the system share memory size.
● IDE0/1 Access Interface	<i>EDB BUS</i> <i>PCI BUS</i>	Access IDE0/1 using EDB BUS. Access IDE0/1 using PCI BUS.
● USB0/1/2/2.0 Access Interface	<i>EDB BUS</i> <i>PCI BUS</i>	Access USB1 using EDB BUS. Access USB1 using PCI BUS.
● MAC Access Interface	<i>EDB BUS</i> <i>PCI BUS</i>	Access MAC using EDB BUS. Access MAC using PCI BUS.





## Chapter 3



<u>Item</u>	<u>Option</u>	<u>Description</u>
<ul style="list-style-type: none"><li>Audio Access Interface</li></ul>	<i>EDB BUS</i> <i>PCI BUS</i>	Access Audio using EDB BUS. Access Audio using PCI BUS.



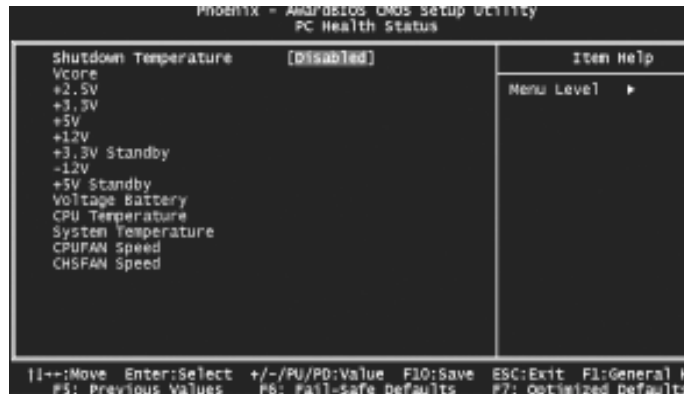

Figure-9 PC Health Status Menu

The following indicates the options for each item and describes their meaning.

<u>Item</u>	<u>Option</u>	<u>Description</u>
<ul style="list-style-type: none"> <li>Shutdown Temperature</li> </ul>	<ul style="list-style-type: none"> <li>60°C/140°F</li> <li>65°C/149°F</li> <li>70°C/158°F</li> <li>75°C/167°F</li> <li>Disabled</li> </ul>	<p>The system will shut down automatically under the ACPI OS when the CPU temperature reaches the previous setting, 60°C/140°F, 65°C/149°F, 70°C/158°F, 75°C/167°F.</p> <p>The system remains on regardless of how much the CPU temperature is.</p>
<ul style="list-style-type: none"> <li>Vcore</li> <li>+2.5V/+3.3V</li> <li>+5 V/+12 V</li> <li>+3.3V Standby</li> <li>-12 V</li> <li>+5V Standby</li> <li>Voltage Battery</li> </ul>		<p>Display current voltage value including all significant voltages of the mainboard.</p> <p>Display the voltage of battery.</p>
<ul style="list-style-type: none"> <li>CPU/System Temperature</li> </ul>		<p>The temperature of CPU/System.</p>
<ul style="list-style-type: none"> <li>CPUFAN Speed</li> <li>CHSFAN Speed</li> </ul>		<p>RPM (Revolution Per Minute) Speed of fan.</p> <p>Fan speed value is based on an assumption that tachometer signal is two pulses per revolution. In other cases, you should regard it relatively.</p>





## Password Setting

When this function is selected, the following message appears at the center of the screen to assist you in creating a password.

### ***ENTER PASSWORD***

Type the password, up to eight characters, and press <Enter>. The password typed now will clear any previously entered password from CMOS memory. You will be asked to confirm the password. Type the password again and press <Enter>. You may also press <Esc> to abort the selection.

To disable password, just press <Enter> when you are prompted to enter password. A message will confirm the password being disabled. Once the password is disabled, the system will boot and you can enter BIOS Setup freely.

### ***PASSWORD DISABLED***

If you have selected “**System**” in “Security Option” of “BIOS Features Setup” menu, you will be prompted for the password every time the system reboots or any time you try to enter BIOS Setup.

If you have selected “**Setup**” at “Security Option” from “BIOS Features Setup” menu, you will be prompted for the password only when you enter BIOS Setup.

Supervisor Password has higher priority than User Password. You can use Supervisor Password when booting the system or entering BIOS Setup to modify all settings. Also you can use User Password when booting the system or entering BIOS Setup but can not modify any setting if Supervisor Password is enabled.

## Boot with BIOS defaults

If you have made all the changes to CMOS values and the system can not boot with the CMOS values selected in setup, clear CMOS after power-down, then power on again. System will boot with BIOS default settings.



# Appendix

## QDI Utility CD

A QDI Utility CD is supplied with this mainboard, the contents contained in it are showed as below:

### 1. Driver Install

Using this choice, you can install all the drivers for your mainboard . You should install the drivers in order, and you need to restart your computer until all the drivers are installed.

- A. Chipset software
- B. USB2.0 Driver
- C. Network Driver(optional)
- D. Audio Driver(optional)
- E. DirectX

### 2. Accessory

- A. Norton AntiVirus 2002
- B. QFlashV1.0
- C. StepEasy II (optional)

### 3. Browse CD

You could read all the contents contained in this CD, including Utility and Documents. The files included in **Utility** are:

- A. Awdflash.exe
- B. Cblog.exe
- C. Lf.exe

The files included in **Documents** are:

- A. Adobe Acrobat Reader V5.0
- B. Superb 4V-French.doc,Superb 4V-Spanish.doc( Optional )

## Norton AntiVirus

When you install Norton AntiVirus and accept options, your computer is safe. Norton AntiVirus automatically checks boot records for viruses at system startup, Checks programs for viruses at the time you use them, scans all local hard drives for viruses once per week, and monitors your computer for any activity that might indicate the work of a virus in action. It also scans files you download from the internet and checks floppy disks for boot viruses when you use them.

The list below shows the most important tasks Norton AntiVirus helps you perform: Scan for viruses on your computer;Remove viruses from your computer;Update your virus protection with LiveUpdate;Quarantine an infected file. you can go to the Symantec Web site to view an online tutorial:

<http://www.symantec.com/techsupp/tutorial>





# LogoEasy II



Thank you for using QDI upgraded innovation--- LogoEasy II, which is completely compatible with LOGOEASY. LOGOEASY II can be easily operated in a Windows environment, following in steps with the trend. It has added the functions of supporting JPEG images and true color display of 64K and 16M colors with regard to JPEG-format graphics files and the high-precision display equipment, which are now widely used. LOGOEASY II supports the high-resolution 640x480 or 800x600 image display and full-screen, top right corner or bottom right corner display. It also supports simultaneous display of logo and sign-on message of the BIOS testing system. LOGOEASY II is a tool that can be operated in multi-platforms to refresh and change LOGO graphics including DOS, WINDOWS 9X, WINDOWS NT, WINDOWS ME and WINDOWS XP. In particular, the tools under the interface of WINDOWS are simple and easy to operate. It teaches you by taking your hand how to change LOGO.

ITEM		LogoEasy II	LogoEasy
Colors	16 colors	✗	✗
	256colors	✓	✓
	16M colors	✓	✗
Resolution	640*480	✓	✓
	800*600	✓	✗
Display Self-Test msg at the same time		✓	✓
Full Screen Logo		✓	✓
Display logo on comers		✓	✓

✓ ----- Support      ✗ ----- Not Support

When you power on or reset your system, the picture shown below will be displayed on the screen.

You can use “**LogoEasy II**” to replace it by any other logo which you want.

We provide two Utilities in the QDI Driver CD , which bring user the following two means to select:



**A. Using CBLOGO.EXE Utility (Under DOS ):**

1. Copy “CBLOGO.EXE” and “AWDFLASH.EXE” from the directory \Utility located on QDI Driver CD to your hard disk.
2. Get the BIOS file from “AWDFLASH.EXE” or Download the BIOS file from the Website (<http://www.qdigrp.com>) and copy the BIOS file (xxxxxx.bin) to your hard disk.
3. Boot the system into DOS environment, Put your favor picture into BIOS file by “CBLOGO.EXE” command. For example: CBLOGO.EXE xxxxxx.bin myphoto.bmp
4. Flash the BIOS to motherboard by “AWDFLASH.EXE”. For example: AWDFLASH xxxxxx.bin

**B. Using QFlash (Under Windows ):**

1. Download the QFlash Utility from the Website (<http://www.qdigrp.com>) or get it from QDI Driver CD.
2. Run QFlash program step by step, following the directions until complete it .
3. Reboot the system, you can see the new picture displayed on the screen.

**Note:**

- 
1. If you require more parameters information concerning “CBLOGO.EXE”, please refer to the online help. If you don't prefer the logo displayed on the screen during bootup, set the “Show Bootup Logo” option as Disabled in CMOS Setup.
  2. We reserve the right of modifying the default full-logo of QDI without further notification.
- 





# RecoveryEasy II



## Introduction:

RecoveryEasy II — the latest edition of RecoveryEasy, providing a more easy-to-operate and more secure and reliable tool for backing up and recovering the hard disk data. It will make your data on the hard disk more secure, and make your computer more reliable. RecoveryEasy II will bring you invaluable experiences. It allows you to experience unprecedented security and reliability with its one-hotkey backup, one-hotkey recovery and powerful virus-free functions.

## Features:

RecoveryEasy II has the following features:

- **Secure Backup**

- (1) Backup area can be reserved automatically in the High Memory Block (HMB) and all of partitions can be adjusted automatically .
- (2) Backup area is invisible to any operating system and its upper software, making it impossible to be attacked completely.

- **Ease to Operate**

- (1) RecoveryEasy II is supported in both Chinese and English. You can easily enter Backup or Recover interface by simply pressing hotkeys. Backup or recover operation can be done with simple choices.
- (2) User are not required to define the size of backup area. When backup start, it will automatically allocate an area in the High Memory Block (HMB) of hard disk as backup area upon the necessity of data storage, so as to improve the utilization of hard disk space.

- **Advantage Function**

- (1) Multiform partition format can be supported in RecoveryEasy II, including FAT16, FAT32, NTFS etc.
- (2) The capability of supportable Hard Disk is up to 137GB.

- **Flexible Combination**

The hard disk data can be choosed to be protected and restored as required.



The following attachment is Backup and Recovery Function table:

Backup	Backup content	Restore content
Partition Table	Partition Table	Partition Table
System Partition	System Partition+Partition Table	System Partition, PartitionTable
Whole Disk	All Partitions+Partition Table	System Partition, PartitionTable, Whole Disk
CMOS Setup	CMOS Setup	CMOS Setup

### Menu Language and Hotkey Selection

Please press “DEL” key to enter CMOS setup during the POST(Power On Self Test), then user can see [RecoveryEasyII Setting] items of the “QDI Innovation features” menu, in which the language on RecoveryEasyII interface and hotkey could be selected .

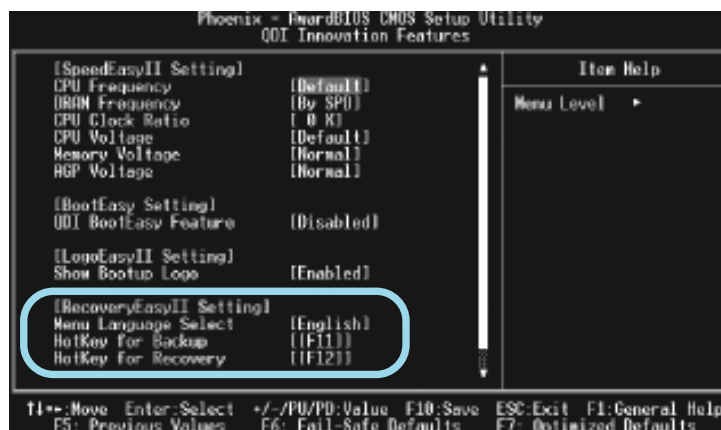

figure-1 QDI Innovation Features

#### 1 Menu language Select

We provide two menu language for user to select, English is the default.

#### 2 Hot key for Backup

There are 12 options, including NULL and F2~F12. Key F11 is default.

If NULL is selected, Backup interface can not be used with pressing hotkey. If you select one key of the rest 11 options, you can enter Backup interface by pressing the hotkey you setup during POST.





### 3 Hot key for Recovery

There are 12 options, including NULL and F2~F12. Key F12 is default. If NULL is selected, Restore interface can not be used with pressing hotkey. If you select one key of the rest 11 options, you can enter Recover interface by pressing the hotkey you setup during POST.

**NOTE:**

If the Backup hotkey and Recover hotkey have been set with the same key, the default will be Backup hotkey.

### Hard Disk Selection Menu

If you installed the system with several IDE hard disks, and you have pressed the backup or restore hotkey during POST, hard disk selection menu will popup before you enter backup or recovery interface, in which all of the IDE hard disks installed on your system will be listed. You can scroll the highlight bar to the hard disk you want to work with using arrow key. Press ENTER to confirm, and the following operation will be performed on the selected hard disk:



figure-2 Hard Disk Select

### Backup Function Introduction

press Backup Hotkey to enter Backup Interface during the POST(Power On Self Test), then the following interface will appear. You can scroll the highlight bar to the option you want to work with using arrow key. Press ENTER to confirm.

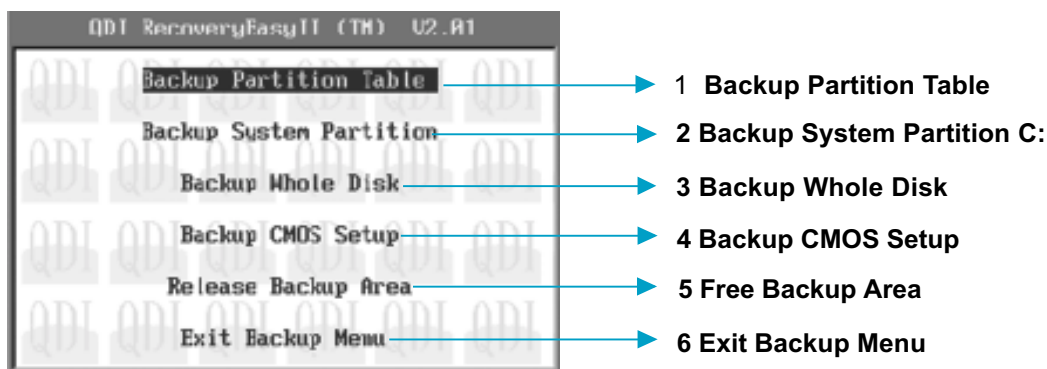

figure-3 Backup Interface



### 1 Backup Partition Table

It is used to backup partition table of current hard Disk. A partition table keeps the status of the hard disk partitions, such as the number of partitions, the type and size of each partition, etc. It is the most important information of the hard disk data structure. The incorrectness or loss of the table will result in the failure of reading data from the hard disk partitions.

### 2 Backup System Partition

It is used to backup the system partition of current hard disk. It makes a backup of the data in the bootable partition (activated partition) of current hard disk, as well as the partition table.

### 3 Backup Whole Disk

It makes a backup of all the useful data on the hard disk, including partition table and the data in all partitions.

### 4 Backup CMOS Setup

It is used to backup the settings you have made in the CMOS Setup.

### 5 Release Backup Area

It is used to unload the backup data on the hard disk, freeing the hard disk space.

### 6 Exit Backup Menu

It is used to Exit Backup Interface.

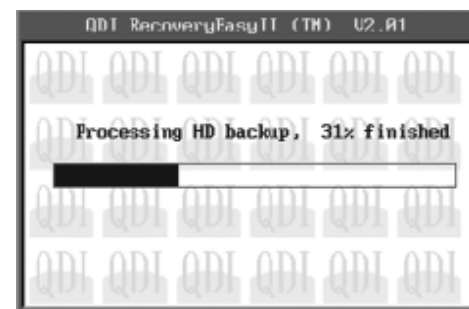
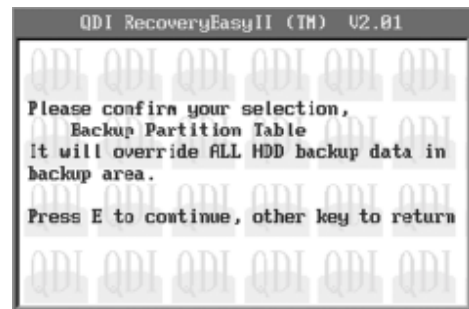

figure-4 Backup process

### Recovery Function Introduction

Press Recovery Hotkey to enter Recovery Interface during the POST (Power On Self Test), then the following interface will appear. You can scroll the highlight bar to the option you want to work with using arrow key. Press ENTER to confirm.





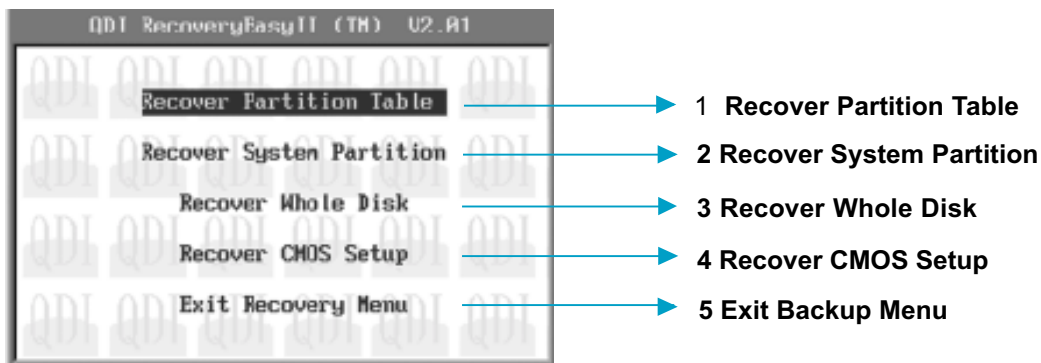

figure-5 Recover Interface

### 1.Recover Partition Table

It used to restore the partition table data stored in backup area to current Hard Disk.

### 2.Recover System Partition

It used to restore the system partition data stored in current backup area to current system partition. If current system partition doesn't match the backup system partition, a warning will be displayed indicating the recovery fails. This feature will only restore the bootable partition and contents in other partitions will be untouched.

### 3.Recover Whole Disk

It used to restore all the Hard Disk data stored in current backup area to current Hard Disk. This operation will restore the partition table and data in all partitions, as a result, existing data in current Hard Disk will be overwritten.

### 4.Recover CMOS Setup

This will restore the latest backup of the CMOS Settings you have made to the current CMOS.

### 5 Exit Recovery Menu

It is used to exit Recovery Interface.

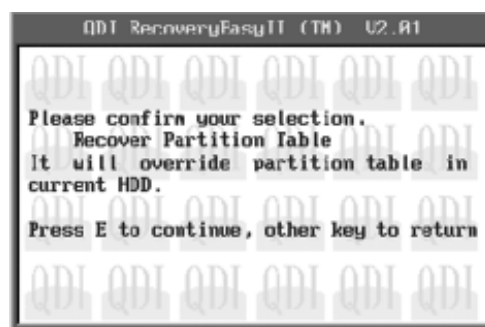

figure-4 Recover process



## SpeedEasy II



### Overview:

SpeedEasy II — has just recommended is the upgraded edition of SpeedEasy In addition to some functions of SpeedEasy, including the wire jumper-free function, the users can also realize in the BIOS setup the CPU core voltage adjustability. This doubtless renders a quicker and easier mode for overclocking and will further help the users to tap the maximum potentiality of the system.

### Procedures:

1. Correctly insert the your CPU.
2. Plug in other configurations and restore the system.
3. Switch on power to the system and press the <Del> key to enter BIOS Setup.
4. Enter “QDI Innovation features” menu to set up the CPU speed.
5. Set CPU Clock ratio and CPU/DRAM Frequency and adjust CPU voltage.
6. Save and exit BIOS Setup, your system will now boot successfully.

### CPU SpeedEasyII Setup Menu

Select <QDI Innovation features> item from the main menu and enter the sub-menu:

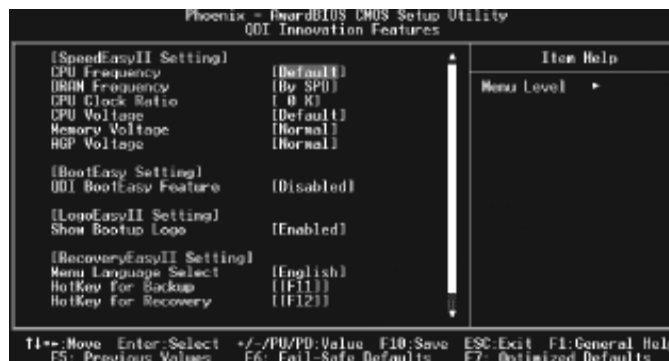

### QDI Innovation features Menu

BIOS provides you with a set of basic values for your processor selection instead of the jumper settings. The processor speed can be manually selected on the “QDI Innovation features” menu screen.

### Warning

**Do not set CPU frequency higher than its working frequency. If you do, we will not be responsible for any damages caused.**

# BootEasy



BootEasy technology enormously improves the long BOOT process time of computers. Reducing the wait time every user has to suffer when starting their computer. BIOS without BootEasy has to perform many routines every time when the system starts, such as checking system core of the computer and initializing system peripherals. Now with the BootEasy, BIOS will not run these repetitive Processes any longer, PC can boot-up without any redundant waiting for the displaying of starting OS. BootEasy is quite easy to use, choose the right option in CMOS SETUP, (refer to QDI Innovation features) it can be easily booted quickly. BootEasy save all the information when PC first normally boot-up, and it restores all the parameters for the system and thus let the PC boot freely and rapidly.

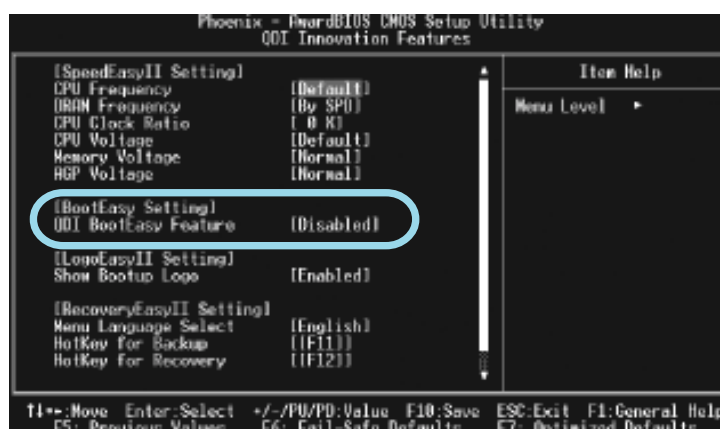

## Note:

- Under the following conditions, PC will boot-up in normal way.
  - PC boot-up for the first times after set option as Enabled.
  - the system information saved by BIOS was damaged.
  - PC fail to boot-up continually over three times.

**Setting the jumper BIOS\_WP as open if you encounter the vabove conditions.**
- Don't power off or reset system while BootEasy initializing.
- Set "QDI BootEasy Feature" as "Disabled" before you replace system equipment.  
Set "QDI BootEasy Feature" as "Enabled" after you accomplished replacing.



# StepEasyII



As one of the Legend QDI's innovations, StepEasyII is a powerful and efficient Easy Technology for PC DIY fans. It provides a friendly interface for you that you can adjust the CPU frequency conveniently and directly. It is so powerful that you can change the CPU frequency just in a few seconds under the operating system (Windows 95/98/ME/2000/NT) and have no need to reset the PC or change the jumpers. In addition, StepEasyII can decrease the risk of changing the CPU frequency to minimum. As long as you conform to the steps of tuning the CPU frequency, there is almost no risk to adjust the frequency. Its second strong function is system monitoring, enables you to view some key reference data concerning computer health in real time. The following figure is the StepEasyII interface for your reference:

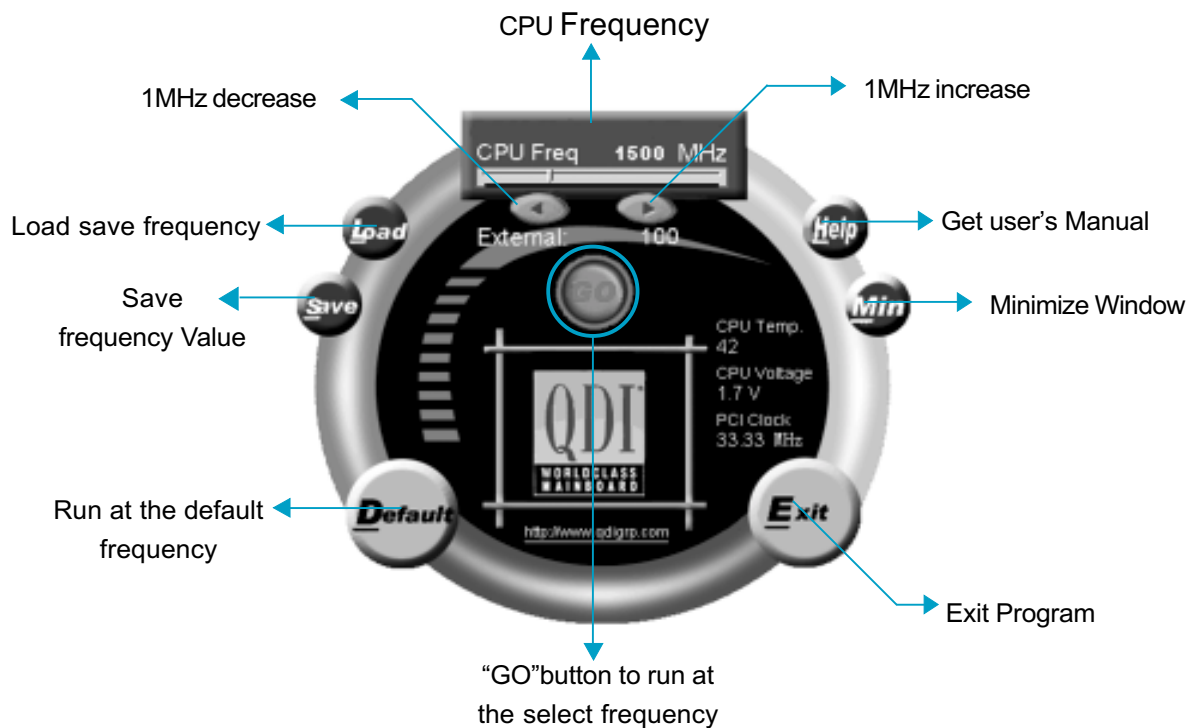

## Installation

You can install the QDI StepEasyII (Optional) by the following two means:

1. Run CD, select the installation of QDI StepEasyII, then, act step by step according to the interface prompt.
2. Browse CD and run the setup.exe in the relative directory.



## BIOS-ProtectEasy



The BIOS of the mainboard is contained inside the Flash ROM. Severe viruses such as CIH virus are so dangerous that it may overwrite the BIOS of the mainboard. If the BIOS has been damaged, the system will be unable to boot. We provide the following solution which protects the system BIOS from being attacked by such viruses.

There are two choices which implements this function.

1. Set the jumper (BIOS\_WP) as closed, the BIOS can not be overwritten.
2. Set the jumper (BIOS\_WP) as opened, meanwhile set "Flash Write Protect" as

Enabled in CMOS Setup. In this way, the BIOS can not be overwritten, but the DMI information can be updated.



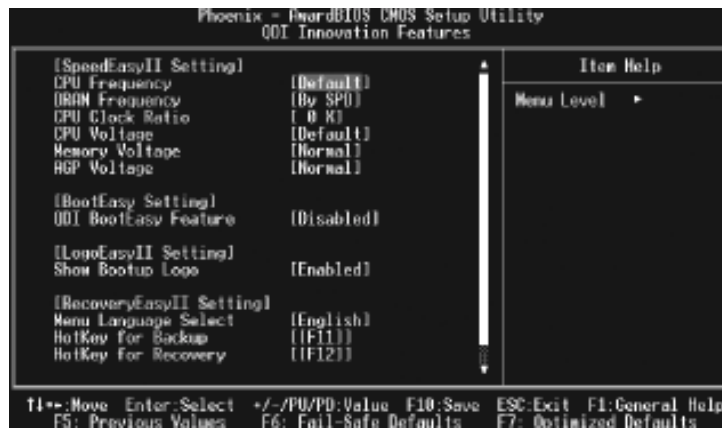

*BootEasy Setup Menu*

Mit der BootEasy- Technologie Technik wird der Bootvorgang nur noch vier bis fünf Sekunden in Anspruch nehmen, bis das Betriebssystem geladen wird. Der Grund für die lange Wartezeit liegt in den Routine-Abfragen, die das BIOS bei jedem Start abarbeitet. So wird beispielsweise jedes Mal die Taktfrequenz des Prozessors geprüft oder angeschlossene Geräte aktiviert. Die BootEasy-Technik prüft diese Punkte nur beim erstmaligen Start des Rechners und speichert die Ergebnisse in einem Flash ROM. Beim nächsten Start ruft das System lediglich diese Informationen aus dem Speicher ab und kann so innerhalb von wenigen Sekunden den Boot-Prozess abschließen. Bei Änderungen am System, beispielsweise nach dem Einbau eines neuen Prozessors, muss deshalb zuvor die BootEasy-Funktion deaktiviert werden, beim nächsten Start werden die neuen Informationen dann erneut abgespeichert. Falls Fehler im Flash ROM den Bootvorgang behindern, versucht das System drei Mal den Rechner hochzufahren, bei Misserfolg schaltet es auf die althergebrachte Art zu booten um, das heißt, es dauert wieder ebenso lang wie früher. Anschließend kann die BootEasy – Technik wieder aktiviert werden. Falls Fehler im Flash ROM den Bootvorgang behindern, versucht das System drei Mal den Rechner hochzufahren, bei Misserfolg schaltet es auf die althergebrachte Art zu booten um, das heißt, es dauert wieder ebenso lang wie früher. Anschließend kann die BootEasy – Technik wieder aktiviert werden.





## **Instalación de la placa base Legend-QDI S4V(Spanish):**

1. Asegúrese que se incluyen los siguientes artículos: Placa base Legend-QDI S4V, 1 cable de datos para el puerto IDE y 1 cable de datos para el Floppy, jumpers, 1 manual de usuario Legend-QDI S4V y un disco compacto con los controladores de la placa base Legend-QDI S4V.
2. Asegúrese de que el cable de la fuente de alimentación está desconectado y asegúrese de estar en contacto a masa utilizando una pulsera antiestática. Si no dispone de dicha pulsera, toque un objeto directamente conectado a masa o una parte metálica de su equipo como puede ser la caja de este.
3. Fije la placa base en la caja de su equipo con los tornillos especiales que acompañan a su caja.
4. Los jumpers están localizados en la placa base, con ellos se configuran, por ejemplo: Clear CMOS JCC, Habilitar BIOS ProtectEasy JAV etc..., el PIN1 para todos los jumpers está marcado con una línea más gruesa (Consulte el apartado "Jumper Settings" en el manual de usuario de su placa Legend-QDI S4V en el capítulo 2).
5. Inserte el procesador en el socket y conecte el ventilador del procesador en el conector de su placa base Legend-QDI S4V marcado como "CPUFAN".
6. Inserte los módulos de memoria en los bancos de memoria DIMM de su placa base Legend-QDI S4V.
7. Inserte las tarjetas PCI y/o la tarjeta y AGP en las bahías de expansión de su placa base Legend-QDI S4V.
8. Conecte los periféricos internos IDE y las disqueteras mediante los cables de datos específicos a su placa base Legend-QDI S4V. Asegúrese que la orientación de los cables sea la correcta. (El cable rojo se corresponde con el pin 1).
9. Conecte los cables de la caja del ordenador a su placa base Legend-QDI S4V, como el conector de la fuente de alimentación, los testigos de corriente, y lectura de disco duro, interruptores de inicio y reset (consulte el apartado "External Connectors" del manual de usuario de su placa base Legend-QDI S4V).



10. Conecte los diferentes periféricos externos como el teclado PS/2, ratón PS/2, serie o USB, los dispositivos USB, el monitor y la impresora a la placa base Legend-QDI Superb 4V (consulte el apartado “External Connectors” en el manual de su placa base Legend-QDI Superb 4V, en el capítulo 2).
11. Cuando haya finalizado de realizar todas las conexiones, conecte el cable de alimentación a la fuente de alimentación y encienda su PC:

### **Instalación del sistema:**

1. Encienda su equipo mediante el interruptor de encendido de la caja.
2. Presione la tecla « Supr » para entrar en el menú de configuración de la BIOS.
3. Seleccione los valores de la Bios en concordancia con la configuración de su sistema (Nosotros le recomendamos que deje los valores establecidos por la Bios por defecto, para evitar posibles fallos que ocasionen que su sistema no funcione correctamente). Para más información las funciones de la Bios, consulte el apartado “BIOS Description” en el manual de usuario de la placa base Legend-QDI Superb4). Presione la tecla « F10 » y seleccione la opción “Save & Exit Setup” en el menú de configuración de la Bios para guardar los cambios y reiniciar el sistema.
4. Instale el sistema operativo en el disco duro, no se olvide de seleccionar la secuencia de inicio correcta para que el sistema operativo pueda iniciarse.
5. Después de la instalación del sistema operativo, asegúrese que no hay conflictos con ningún dispositivo de su sistema.
6. Entonces, después del último paso, proceda a la instalación de los controladores de los diferentes dispositivos.

**Un disco compacto con controladores de Legend-QDI esta incluido en el paquete de la placa base Legend-QDI Superb 4V.**

#### **1. Instalación de los controladores**

Usted puede instalar todos los controladores para su placa base facilmente. Tiene que instalar los controladores en el siguiente orden para un correcto funcionamiento del sistema, y es necesario reiniciar el equipo antes de finalizar la instalación de los controladores.







- A. Chipset software
- B. Network Driver (Opcional)
- C. Audio Driver (Opcional)
- D. DirectX
- E. USB2.0(Opcional)

## **2. Accesorios**

- A. QFlash
- B. Norton AntiVirus
- C. StepEasy II (optional)

## **3. Navegue por el CD**

Usted puede leer todos los documentos incluidos en este CD, incluidos Utility and Documents.

Los ficheros incluidos en **Utility** son:

- A. Awdflash.exe
- B. Cblog.exe
- C. Lf.exe



## Manuel d'installation des cartes mères de la série Legend-QDI S4V (French):

### Intégration du système :

1. Vérifier la présence de chaque élément dans la boîte de la carte mère de la série Legend-QDI S4V :
  - Une carte mère de la série Legend-QDI S4V.
  - Un CD-ROM d'installation Legend-QDI.
  - Un manuel d'utilisation de la carte mère Legend-QDI S4V.
  - Un sachet de cavaliers.
  - Une nappe IDE compatible avec la norme ATA/66 destinée au lecteur de disque dur.
  - Une nappe destinée au lecteur de disquette.
  - Un fond de panier métallique destiné à l'unité centrale de l'ordinateur (Caractéristique technique optionnelle).
  - Un câble d'extension destiné à permettre l'exploitation des ports USB 3 et USB 4 ou USB 5 et USB 6 (Caractéristique technique optionnelle).
2. Vérifier que le câble électrique relié au boîtier d'alimentation de l'unité centrale de l'ordinateur est déconnecté. Se relier à la terre grâce à un bracelet lié au poignet. A défaut de disposer d'un bracelet, maintenir un contact physique avec un objet lui-même relié à la terre, ou à une partie métallique du système comme la structure de l'unité centrale de l'ordinateur.
3. Fixer la carte mère dans l'unité centrale de l'ordinateur grâce aux vis fournies avec cette dernière lors de son achat.
4. S'assurer que la carte mère de la série Legend-QDI S4V est matériellement correctement configurée, pour cela vérifier que les cavaliers insérés sur les broches intégrées de cette dernière sont correctement positionnés. Dans ce but il est important de se référer à la section nommée « Configuration des cavaliers » du chapitre numéro 2 nommé « Instructions d'installation » contenu dans le manuel d'utilisation livré avec la carte mère de la série Legend-QDI S4V lors de son achat.





5. Connecter le processeur dans le socket intégré à la carte mère de la série Legend-QDI Superb 4V et prévus à cet effet. Fixer le système de refroidissement de ce dernier et connecter son ventilateur sur les broches nommées « CPUFAN » intégrées à la carte mère de la série Legend-QDI Superb 4V et prévus à cet effet.
6. Connecter les éventuelles barrettes de mémoire dans les slots intégrés à la carte mère de la série Legend-QDI Superb 4V et prévus à cet effet.
7. Connecter les éventuelles cartes d'extension au format AGP, ou PCI dans les slots intégrés à la carte mère de la série Legend-QDI Superb 4V et prévus à cet effet.
8. Connecter les éventuels périphériques IDE ainsi que le lecteur de disquette à la carte mère de la série Legend-QDI Superb 4V grâce aux nappes fournies avec cette dernière lors de son achat. S'assurer que l'orientation des nappes connectées est correcte en vérifiant que le liseré rouge de ces dernières correspond à l'emplacement de la broche numéro 1 du connecteur.
9. Connecter les câbles de l'unité centrale de l'ordinateur sur les broches intégrées à la carte mère de la série Legend-QDI Superb 4V et prévues à cet effet. Dans ce but il est important de se référer à la section nommée « Connecteurs externes » du chapitre numéro 2 nommé « Instructions d'installation » contenu dans le manuel d'utilisation livré avec la carte mère de la série Legend-QDI Superb 4V lors de son achat.
10. Raccorder les périphériques externes sur les connecteurs de fond de panier intégrés à la carte mère de la série Legend-QDI Superb 4V. Dans ce but il est important de se référer à la section nommée « Connecteurs externes » du chapitre numéro 2 nommé « Instructions d'installation » contenu dans le manuel d'utilisation livré avec la carte mère de la série Legend-QDI Superb 4V lors de son achat.
11. Lorsque tous les éléments du système sont correctement intégrés, il est possible de reconnecter le câble électrique au boîtier d'alimentation de l'unité centrale de l'ordinateur.



## **Installation du système :**

1. Démarrer le système en pressant l'interrupteur de fonctionnement de l'unité centrale de l'ordinateur.
2. Presser la touche "Suppr" du clavier afin d'entrer dans le menu de BIOS.
3. Dans le menu de BIOS nommé "QDI Innovation features", ajuster la fréquence de fonctionnement du processeur. Attention, il est fortement recommandé de charger les réglages de sûreté par défaut afin d'éviter un éventuel dysfonctionnement du système. Dans ce but il est important de se référer à la section nommée « Description du BIOS Award » du chapitre numéro 3 nommé « Description du BIOS » contenu dans le manuel d'utilisation livré avec la carte mère de la série Legend-QDI Superb 4V lors de son achat.
4. Procéder à l'installation du système d'exploitation sur le lecteur de disque dur intégré au système. Dans ce but il est important de vérifier que la séquence de démarrage du système paramétrable à partir du menu de BIOS permet à la procédure d'installation du système d'exploitation de s'initialiser.
5. Une fois l'installation du système d'exploitation achevée, vérifier qu'il ne subsiste aucun conflit ou périphérique inconnu au sein du système.
6. Après cette étape, procéder à l'installation des pilotes de chaque périphérique détecté par la carte mère de la série Legend-QDI Superb 4V.

**Lors de son achat un CD-ROM d'installation Legend-QDI est livré avec la carte mère de la série Legend-QDI Superb 4V.**

### **1. Driver Install :**

Avec cette option, il est possible d'installer les pilotes de la carte mère de la série Legend-QDI Superb 4V aisément. Il est important d'installer les pilotes en respectant l'ordre prédéfini et de redémarrer le système après avoir effectué l'installation de tous les pilotes.

Applications contenues dans le dossier :

- A. Pilotes du chipset intégré.
- B. Pilote de la fonction réseau intégrée.





- C. Microsoft DirectX.
- D. Pilote USB2.0

## **2. Accessory :**

Applications contenues dans le dossier :

- A. Qflash.
- B. Symantec Norton AntiVirus 2002.
- C. StepEasy II (optional)

## **3. Browse CD :**

Avec cette option, il est possible de consulter l'ensemble des données contenues sur le CD-ROM d'installation Legend-QDI

Applications contenues dans le dossier :

- A. Awdflash.exe.
- B. Cblog.exe.
- C. Lf.exe.



## Legend-QDI Superb 4V installazione mainboard (Italian):

1. Assicurarsi che la scatola sia completa: Legend-qdi S4Vmainboard, cavo IDE e Floppy, jumpers, manuale dell'utente della mainboard Legend-QDI Superb 4V e cd-rom drivers.
2. Controllare che il cavo alimentazione proveniente dal computer-case sia sconnesso assicurarsi inoltre di aver indossato correttamente il bracciale da polso collegato a massa. In mancanza di questo toccare un punto a massa o una parte metallica del case
3. Fissare la mainboard nel case con le speciali viti fornite con il computer-case
4. I jumper locati sulla mainboard rappresentano: JCC azzeratore BIOS , JAV abilitatore/disabilitatore in BIOS della funzione **protectEasy**; per tutti i jumper il PIN 1 e' contrassegnato da un spessa linea bianca ( consultare il manuale al capitolo 2 " JUMPER AND SETTINGS")
5. Inserire il processore nell'apposito slot ; la ventola del processore deve essere collegato nello speciale connettore targato " CPUFAN ".
6. Inserire il modulo/i di memoria nell'apposito memory slots
7. Inserire le periferiche Pci negli appositi Pci slots
8. Collegare le periferiche IDE e il FLOPPY con l'apposito cavo fornito con la mainboard negli specifici connettori marcati. Assicurarsi che l'orientamento del cavo sia corretto. ( La linea rossa sul cavo deve essere inserita nell'apposito connettore in corrispondenza del pin 1)
9. Conettere la mainboard con: il cavo di alimentazione proveniente dall'alimentatore, il connettore dell'interuttore di stand by, il conettore del led di segnalazione "acceso", il connettore led di funzionalita' HARD DISK, il connettore dello speaker interno al CASE.....( consultare il manuale capitolo 2. " EXTERNAL CONNECTORS ". Dopo chiudere il CASE)





10. Connettere le differenti periferiche esterne come il PS/2 mouse, la PS/2 tastiera, le prese USB, il monitor e la stampante con gli specifici connettori posizionati sulla faccia esterna della mainboard.
11. Quando la vostra configurazione sara' tutta connessa, aggangiare il cavo di alimentazione

### **Installazione di sistema**

1. Portare in posizione di acceso l'interuttore di ACCESO
2. Usare il tasto DEL per entrare nel nel software di configurazione del BIOS
3. Regolare le funzioni del BIOS in accordo con la configurazione di sistema ( Noi ti raccomandiamo di usare l'impostazione di default per evitare rischi di anomalie di funzionalita'). Per maggiori informazioni controllare il capitolo 3, sezione "BIOS DESCRIPITION". Premere F10 sulla tastiera o scegliere "SAVE and EXIT" dal menu di BIOS per salvare le impostazioni scelte ed uscire dal BIOS program.
4. Installare il sistema operativo , non dimenticando di mettere nelle giuste condizioni di partenza la sequenza di boot.
5. Dopo una giusta installazione accertarsi che non vi siano conflitti tra le periferiche in uso
6. Dopo questo ultimo passo procedere all'installazione dei driver delle varie periferiche

### **IL CD CONTENENTE I DRIVER DELLA VOSTRA MAINBOARD LEGEND-QDI E' CONTENUTO NELLA SCATOLA**

#### **1. Installazione driver**

E possibile installare tutti i driver della Vs. mainboard in modo facile e veloce. Dovreste installare i driver nella seguente succesione, finito cio' bisogna far ripartire il personal computer.

- |                            |                              |
|----------------------------|------------------------------|
| A. Chipset software        | B. Network Driver (Optional) |
| C. Audio Driver (Optional) | D. DirectX                   |
| E. USB2.0 Driver           |                              |





- A. Qflash
- B. Norton AntiVirus
- C. StepEasy II (optional)

Guardando il CD

Questo manuale di installazione e' disponibile anche nella sua versione elettronica all'interno del cd accompagnativo, insieme anche diverse utili quali:

- A. Awdflash.exe
- B. Cblog.exe
- C. Lf.exe







# Board Layout of Superb 4V

This layout is just for your reference

