

RI7SM Series
Full-Size Socket 370 CPU Card
Version 1.0

Server Board
PC-Based Computer Boards for 1L/2L Server Board
User's Manual

Copyright Notice

This publication is protected by copyright and all rights are reserved. No part of it may be reproduced or transmitted by any means or in any form, without prior consent of the original manufacturer.

The information in this document has been carefully checked and is believed to be accurate. However, the original manufacturer assumes no responsibility for any inaccuracies that may appear in this manual. In no event will the original manufacturer be liable for direct, indirect, special, exemplary, incidental, incidental or consequential damages resulting from any defect or omission in this manual, even if advised of possibility of such damages. The material contained herein is for informational purposes only.

Acknowledgments

Award is a registered trademark of Award Software International, Inc.
PS/2 is a trademark of International Business Machines Corporation.
SMI is a trademark of Silicon Motion and Technologies Inc.
Intel and Celeron are registered trademarks of Intel Corporation.
Microsoft Windows is a registered trademark of Microsoft Corporation.
All other product names or trademarks are properties of their respective owners.

Remarks:

The RI7SM flexible design allows it to integrate Intel 815E, One Ethernet functions according to customer requirements. The following products are used in conjunction with the RI7SM board:

- **DVS72V** SMI721 VGA MicroPCI Daughter Card
- **DPR300** Promise 20265/20267 IDE RAID 0+1 MicroPCI Daughter Card
- **DVL68V** C&T 69000VGA MicroPCI Daughter Card

Contents

Chapter 1 Introduction	1
Checklist.....	2
Introduction.....	3
Specifications	3
Intelligence.....	6
Chapter 2 Installations	7
CPU Installation.....	8
Memory Installation	9
Jumpers on the RI7SM.....	10
Connectors on the RI7SM.....	14
Watchdog Timer Configuration.....	25
Chapter 3 BIOS Configuration.....	27
Chapter 4 815E Chipset Driver Installation Guide.....	55
Chapter 5 VGA Driver Installation Guide.....	57
Chapter 6 Audio Driver Installation Guide.....	59
Chapter 7 LAN Driver Installation Guide.....	61
Chapter 8 Ultra ATAIDE Driver Installation Guide.....	81
Appendix.....	83
A. I/O Port Address Map	84
B. Interrupt Request Lines (IRQ).....	85



Chapter 1

Introduction

This manual is designed to give you information on the RI7SM Server Board. It is divided into the following sections:

Checklist	2
Introduction	3
Specifications	3
Intelligence.....	6

The topics covered in this chapter are as follows:

- ◆ Checklist
- ◆ Description
- ◆ Features
- ◆ Specifications
- ◆ Intelligence

Checklist

Please check that your package is complete and contains the items below. If you discover damaged or missing items, please contact your dealer.

- The RI7SM Server Board
- This User's Manual
- 2 IDE Ribbon Cable
- 1 Floppy Ribbon Connector
- 2 Serial Port Ribbon Cable and 1 Parallel Port Attached to a Mounting Bracket
- 1 IPC CD Driver
- 1 Audio Cable W/Ext CGM Daughter Board
- 1 USB cable Support two channel

Introduction

The RI7SM is one of the most efficient Server Boards in the world. It integrates the Intel Solano chipset (544BGA) or ICH2 chipset (241 BGA) and supports a Socket 370 connector for Intel Pentium III and Celeron processors with frequencies of up to 1GHz. The **MicroPCI sockets** used are SO-DIMM 144-pin sockets that has 120 pins used for standard PCI signals and other pins for VGA and LAN signals.

Equipped with 2 **MicroPCI sockets**, users get to choose to insert VGA/LAN/IDE RAID MicroPCI cards. The DMPCI MicroPCI to PCI adapter can also accommodate these MicroPCI cards. Our server board provides Intel CNR chip 82562ET or 82562EM(AOL) to choose.

The RI7SM is designed with a PCI bridge that is able to support 3 PCI master interfaces. MicroPCI CPU cards offer more reliability in performance and less failure rate in production by integrating all components in only one side of the PCB board. With components on one side, better design and improved quality control is achieved.

Specifications

- **Processor Socket:** Socket 370 connector
- **Processor:** Intel Pentium III/ Celeron 500MHz~1GHz Processor
- **Bus Speed:** 66MHz, 100MHz, 133MHz.
- **Chipset:** Intel 815E Chipset
- **Secondary Cache:** CPU integrated
- **Memory Sockets:**
 - Two 168-pin DIMM sockets
 - Max. 512MB SDRAM
 - Memory type: SDRAM (Synchronous DRAM)
 - NOTE: Only SDRAM modules that support SPD (Serial Presence Detect) should be use. Use PC133 modules when running 133MHz CPU bus speed and use PC66/PC100 modules when running 66MHz /100MHz CPU bus speed.*

-
- **BIOS:** Award BIOS, PnP support
 - The motherboard BIOS provides “Plug & Play” which detects the peripheral devices and expansion cards of the automatically.
 - The motherboard provides a Desktop Management Interface (DMI) function which record your motherboard specifications
 - ACPI Power management
 - **DMI BIOS Support:**
Desktop Management Interface (DMI) allows users to download system hardware-level information such as CPU type, CPU speed, internal/external frequencies and memory size.
 - **LPC I/O:** Winbond W83627HF
 - **PCI TO ISA Bridge:** Winbond W83628/W83629
 - **Parallel Port:** One high-speed parallel port, SPP/EPP/ECP mode
 - **Serial Port:** Two 16550 UART compatible ports with COM1 as RS232 and COM2 as RS232
 - **Enhanced IDE:** Two Bus Mastering EIDE mode, up to 4 devices, Two EIDE interfaces for up to four devices, support PIO Mode 4/5 or Ultra DMA 66/100 IDE Hard Disk and ATAPI CD-ROM.
 - **FDD Interface:** Two floppy drives (360KB, 720KB, 1.2MB, 1.44MB, 2.88MB, LS-120)
 - **USB Interface:** Two USB pin-header connectors, compliant with USB Specification Rev. 1.1
 - **DiskOnChip:** The M-Systems flask disk supports system boot and storage capacity from 2MB to 288MB.
 - **Watchdog Timer:** 16-level, programmable
 - I/O port 0443H to enable watchdog.
 - I/O port 0441H to disable watchdog.
 - Time-out timing select 0/2/4/6/8/10/12/14/16/18/20/22/24/26/28/30 seconds (+/-20%).

-
- **VGA:** Onboard Intel 815E (8/16MB VGA Chipset support Dual panel (18bit) TFT LCD.
 - Simultaneous CRT & LCD display
 - LCD panel supports DSTN/TFT
 - 1280x1024x8bpp colors CRT resolution
 - Up to 1280x1024x8bpp colors resolution for color active matrix TFT panels (12, 18, and 24bit analog) or (12+12), (18+18) double pixel/CLK interface
 - **Green Function:** Power management via BIOS, activated through mouse/keyboard movement.
 - **ICH2 LAN Controller:** DL39B LAN MicroPCI Daughter Card
 - ICH2 LAN controller
 - ICH2 LAN's integrated LAN Controller includes a 32-bit PCI controller that provides enhanced scatter-gather bus mastering capabilities enable the LAN Controller to perform high speed data transfers over the PCI bus. In full duplex mode the LAN Controller adheres with the IEEE 802.3x Flow Control specification.
 - **Keyboard and Mouse Connectors:** PS/2 type mini-DIN that supports PC/AT; supports a 5-pin external keyboard connector
 - **IrDA Interface:** Pin-header connector for the optional IrDA external connector
 - **PICMG Compliance:** Fully compliant to PICMG standards
 - **Environmental and Mechanical:**
 - **Power Supply:** 10A @+5V(max), ±12V: 100mA(max)
 - **Temperature:** 0°C to 60°C
 - **Humidity:** 5% to 95%
 - **Dimensions:** 338mm x 122mm

Intelligence

- **Temperature Monitoring and Alert:** A sensor for the CPU temperature on the RI7SM monitors the CPU temperature and alerts the user through the speaker or buzzer when temperature exceeds the safe heat level.
- **Windows serials shut-off:** Allows shut-off control from within Windows serials and through an ATX power supply.
- **Modem ring-on:** Allows system powering on through an external modem and through AT/ATX power supply.
- **Year 2001 Compliant BIOS:** The onboard Award BIOS is Year 2001 Compliant and will pass software applications that have the tendency to invoke INT1AH function 04H such as year2000.exe utility released by NSTL.
- **Wake On LAN:** Through an ATX power supply and network connection, systems can be turned on from the power-off state. Wake On LAN will function properly only with an ATX power supply with 5VSB that has 800mA.

Chapter 2

Configurations

This chapter provides information on how to use the Jumpers and connectors on the RI7SM in order to set up a workable system. The topics covered are:

CPU Installation	8
Memory Installation.....	9
Jumpers on the RI7SM.....	10
Connectors on the RI7SM.....	14
Watchdog Timer Configuration	25

<p>CAUTION: Danger of explosion if battery is incorrectly replaced. Replace only with the same or equivalent type recommended by the manufacturer.</p>

CPU Installation

The RI7SM Server Board supports a Socket 370 connector processor socket for Intel Pentium III, Corpermine and Celeron processors.

The Socket 370 connector comes with a lever to secure the processor. Before inserting the CPU, make sure the lever is raised perpendicular to the socket and the notch on the corner of the CPU corresponds with the notch on the inside of the socket.

After have installed and lock the processor into place, check if the Jumpers for the CPU type and speed are correct.

NOTE: *Ensure that the CPU heat sink and the CPU top surface are in total contact to avoid CPU overheating problem that would cause your system to hang or be unstable.*

Memory Installation

The RI7SM Server Board supports two 168-pin DIMM sockets for a maximum total memory of 512MB SDRAMs. In populating the DIMM sockets, any of the banks can be populated first.

NOTE: Use SDRAM modules with PC133 specification when running 133MHz CPU bus speed. With 66/100MHz bus speed, SDRAM modules with PC66 or PC100 specification can be used.

168-pin DIMM (3.3V) Unbuffer SDRAM



Bank0 (DIMM1)	Bank1 (DIMM2)	Total Memory
8MB	-----	8MB
16MB	-----	16MB
32MB	-----	32MB
64MB	-----	64MB
128MB	-----	128MB
256MB	-----	256MB
8MB	8MB	16MB
16MB	8MB	24MB
32MB	8MB	40MB
64MB	8MB	72MB
128MB	8MB	136MB
256MB	8MB	264MB
16MB	16MB	32MB
32MB	16MB	48MB
64MB	16MB	80MB
128MB	16MB	144MB
256MB	16MB	272MB
32MB	32MB	64MB
64MB	32MB	96MB
128MB	32MB	160MB
256MB	32MB	288MB
64MB	64MB	128MB
128MB	64MB	192MB
256MB	64MB	320MB
128MB	128MB	320MB
256MB	128MB	384MB
256MB	256MB	512MB

Jumpers on the RI7SM

The Jumpers on the RI7SM allow you to configure your Server Board according to the needs of your applications. If you have doubts about the best jumper configuration for your needs, contact your dealer or sales representative. The following table lists the connectors on RI7SM and their respective functions.

Jumper Locations on the RI7SM.....	11
JP3: AC'97 Audio Enable/Disable	12
JP4: LAN EEPROM Control Content.....	12
JP5: Clear CMOS Content.....	12
JP6: DiskOnChip BIOS Expansion Address Select	12
K1: Wake on LAN Connector	13
J100: CRTVSYNC Jumper Setting.....	13
J101: CRTHSYNC Jumper Setting.....	13
J102, J103, J104: Light Jumper Setting	13

The following examples show the conventions used in this section.

	Jumper Open
	Jumper Closed

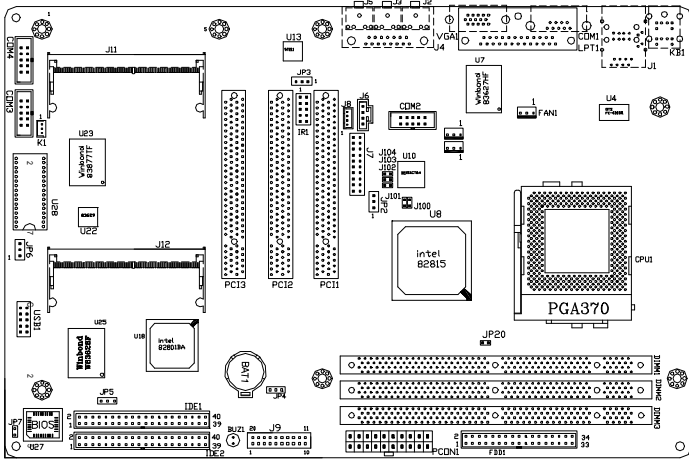

Jumper Locations on the RI7SM





- JP3: AC'97 Audio Enable/Disable
- JP4: LAN EEPROM Control Content
- JP5: Clear CMOS Content
- JP6: DiskOnChip BIOS Expansion Address Select
- K1: Wake on LAN Connector
- J100: CRTVSYNC Jumper Setting
- J101: CRTHSYNC Jumper Setting
- J102, J103, J104: Light Jumper Setting

JP3: AC'97 Audio Enable/Disable



Onboard AC'97 CODEC supports the Audio function. Please refer to the default jumper setting before you proceeding with system installation.

JP3	Setting	Function
	Pin 2-3 Closed	Onboard Audio Enabled
	Pin 1-2 Closed	Onboard Audio Disabled



JP4: LAN EEPROM Control Content

JP4	Setting	Function
	Pin 2-3 Closed	Enable
	Pin 1-2 Closed	Disable

JP5: Clear CMOS Content

JP5	Setting	Function
	Pin 2-3 Closed	Clear CMOS Content
	Pin 1-2 Closed	Normal Operation

JP6: DiskOnChip BIOS Expansion Address Select

JP6	Setting	Function
	Pin 2-3	D8000-DFFFF(default)
	Pin 1-2	D0000-D7FFF

K1: Wake On LAN Connector

The DL39B Realtek 8139B LAN MicroPCI daughter card supports the K1 Wake on LAN connector. The following table shows the pin out assignments of this connector. Wake On LAN will function properly only with an ATX power supply with 5VSB that has 800mA.

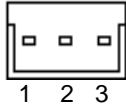



Pin #	Signal Name
1	+5VSB
2	Ground
3	Wake on LAN

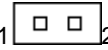

J100: CRTVSYNC Jumper Setting

J100	Setting	Function
	Close	INT VGA
	Open	EXT VGA

J101: CRTHSYNC Jumper Setting

J101	Setting	Function
	Close	INT VGA
	Open	EXT VGA

J102, J103, J104: Light Jumper Setting

Jumper	Setting	Function
J102, J103, J104	 Open	EXT RED, GREEN BLUE
J102, J103, J104	 Close	INT RED, GREEN BLUE

Connectors on the RI7SM

The connectors on the RI7SM allow you to connect external devices such as keyboard, floppy disk drives, hard disk drives, printers, etc. The following table lists the connectors on RI7SM and their respective functions.

Connector Locations on the RI7SM.....	15
J1: RJ45 and USB Connectors.....	16
J4: Game / MiDi Port Connector.....	16
J6, J8: CD-ROM Audio In Connectors.....	17
J9: Front Bezel Connector.....	17
J11, J12: MicroPCI Connector.....	19
JP20: PC100/133 DIMM Select.....	19
Fan1, Fan2, Fan3 CPU Fan Power Connector.....	19
IDE1, IDE2: EIDE Connectors.....	20
IR1: IrDA Connector.....	21
USB1, USB3/4 Connectors.....	21
KB1: PS/2 Keyboard and PS/2 Mouse Connectors.....	21
FDD1: Floppy Drive Connector.....	22
LPT1: Parallel Port Connector.....	22
VGA1: VGA CRT Connector.....	22
COM1, COM2: Serial Ports.....	23
COM3, COM4: Serial Ports.....	24
PCON1: ATX Power Supply Connector.....	24

Connector Locations on the RI7SM

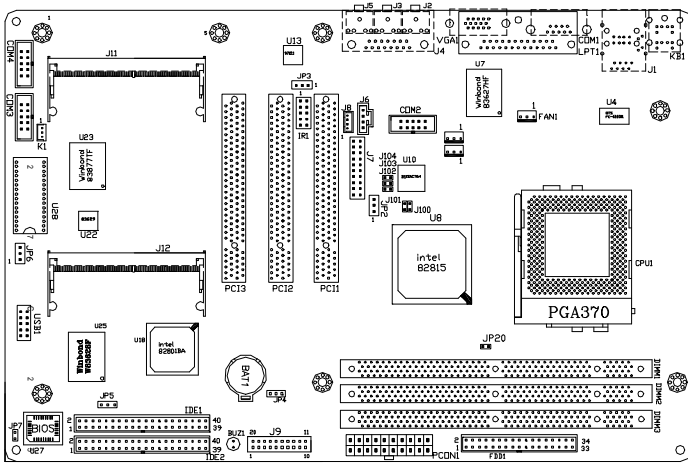

- J1: RJ45 and USB Connectors
- J4: Game / MiDi Port Connector
- J6, J8: CD-ROM Audio In Connectors
- J9: Front Bezel Connector
- J11, J12: MicroPCI Connector
- JP20: PC100/133 DIMM Select
- Fan1, Fan2, Fan3 CPU Fan Power Connector
- IDE1, IDE2: EIDE Connectors
- IR1: IrDA Connector
- USB1, USB2: USB3/4 Connectors
- KB1: PS/2 Keyboard and PS/2 Mouse Connectors
- FDD1: Floppy Drive Connector
- LPT1: Parallel Port Connector
- VGA1: VGA CRT Connector
- COM1, COM2: Serial Ports
- COM3, COM4: Serial Ports
- PCON1: ATX Power Supply Connector

J1: RJ45 and USB Connectors

J1 consists of an RJ-45 connector on top and two stacked USB ports at the bottom. The RJ-45 Ethernet connector supports 10/100Mbps data transfer rates. USB support allows connections of up to 64 plug and play external peripherals per channel.

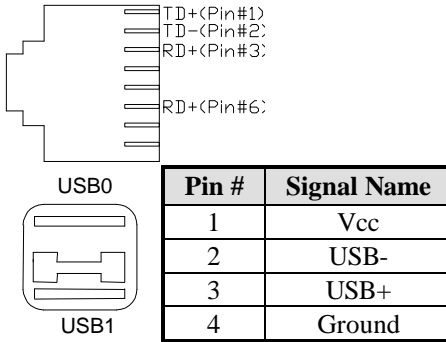

J4: Game / MiDi Port Connector

J4 supports audio port and Joy stick respectively. It is part of the functions provided by the onboard audio controller.

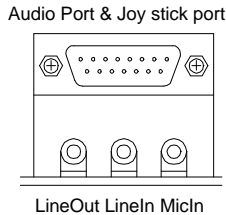

J6, J8: CD-ROM Audio In Connectors

J6 and J8 are the onboard CD-ROM audio in connectors. Below are their pin assignments.

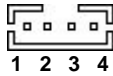

J8

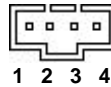

J6

Signal Name	Signal Name	Signal Name	Signal Name
1	Ground	1	Right
2	Left	2	Ground
3	Ground	3	Ground
4	Right	4	Left

J9: Front Bezel Connector

The front bezel of the case has a control panel that provides light indication of the computer activities and switches to change the computer status. J2 is a 20-pin header that provides interfaces for the following functions.

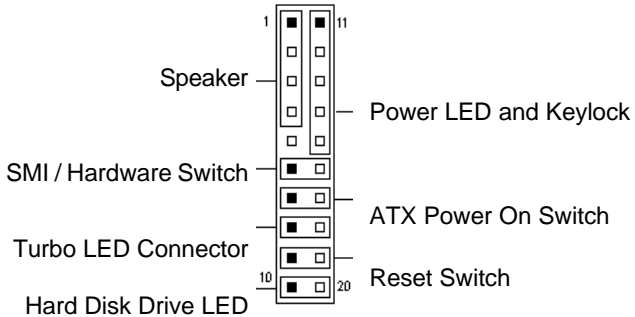

Speaker: Pins 1 - 4

This connector provides an interface to a speaker for audio tone generation. An 8-ohm speaker is recommended.



Pin #	Signal Name
1	Speaker out
2	No connect
3	Ground
4	+5V

Power LED and Keylock: Pins 11 - 15

The power LED indicates the status of the main power switch. The keylock switch, when closed, will disable the keyboard function.



Pin #	Signal Name
11	Power LED
12	No connect
13	Ground
14	Keylock
15	Ground

SMI/Hardware Switch: Pins 6 and 16

This connector supports the "Green Switch" on the control panel, which, when pressed, will force the system into the power-saving mode immediately.

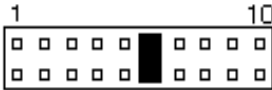

Pin #	Signal Name
6	Sleep
16	Ground

ATX Power ON Switch: Pins 7 and 17

This 2-pin connector is an "ATX Power Supply On/Off Switch" on the system that connects to the power switch on the case. When pressed, the power switch will force the system to power on. When pressed again, it will force the system to power off.

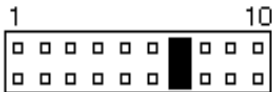

Pin #	Signal Name
7	Power ON
17	VCC5SBY

Turbo LED Connector: Pins 8 and 18

There is no turbo/deturbo function on the CPU card. The Turbo LED on the control panel will always be On when attached to this connector.

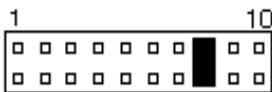

Pin #	Signal Name
8	5V
18	Ground

Reset Switch: Pins 9 and 19

The reset switch allows the user to reset the system without turning the main power switch off and then on again. Orientation is not required when making a connection to this header.

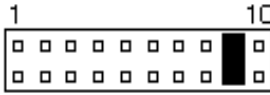

Pin #	Signal Name
9	Reset
19	Ground

Hard Disk Drive LED Connector: Pins 10 and 20

This connector connects to the hard drive activity LED on control panel. This LED will flash when the HDD is being accessed.



Pin #	Signal Name
10	Ground
20	5V

J11, J12: MicroPCI Connector

J11 and J12 are MicroPCI connectors supporting the MicroPCI daughter cards with VGA, Ethernet or SCSI function.

JP20: PC100/133 DIMM Select

JP20 connector provides the option of PC100/133 DIMM for user.

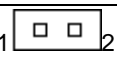
JP20	Setting	Function
	Close	For PC 133 DIMM
	Open	For PC 100 DIMM

Fan1, Fan2 and Fan3 CPU Fan Power Connector

Fan1, Fan2 and Fan3 are 3-pin header for the CPU fans. These fans must be 12V fan.

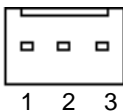

Pin #	Signal Name
1	Rotation
2	+12V
3	Ground

IDE1, IDE2: EIDE Connectors

IDE1: Primary IDE Connector

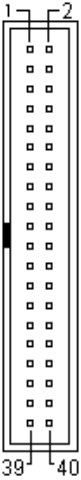

IDE1

Signal Name	Pin #	Pin #	Signal Name
Reset IDE	1	2	Ground
Host data 7	3	4	Host data 8
Host data 6	5	6	Host data 9
Host data 5	7	8	Host data 10
Host data 4	9	10	Host data 11
Host data 3	11	12	Host data 12
Host data 2	13	14	Host data 13
Host data 1	15	16	Host data 14
Host data 0	17	18	Host data 15
Ground	19	20	Key
DRQ0	21	22	Ground
Host IOW	23	24	Ground
Host IOR	25	26	Ground
IOCHRDY	27	28	Host ALE
DACK0	29	30	Ground
IRQ14	31	32	No connect
Address 1	33	34	No connect
Address 0	35	36	Address 2
Chip select 0	37	38	Chip select 1
Activity	39	40	Ground

IDE2: Secondary IDE Connector

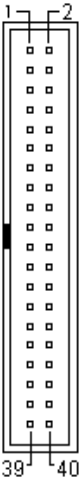

IDE2

Signal Name	Pin #	Pin #	Signal Name
Reset IDE	1	2	Ground
Host data 7	3	4	Host data 8
Host data 6	5	6	Host data 9
Host data 5	7	8	Host data 10
Host data 4	9	10	Host data 11
Host data 3	11	12	Host data 12
Host data 2	13	14	Host data 13
Host data 1	15	16	Host data 14
Host data 0	17	18	Host data 15
Ground	19	20	Key
DRQ1	21	22	Ground
Host IOW	23	24	Ground
Host IOR	25	26	Ground
IOCHRDY	27	28	Host ALE
DACK1	29	30	Ground
IRQ15	31	32	No connect
Address 1	33	34	No connect
Address 0	35	36	Address 2
Chip select 0	37	38	Chip select 1
Activity	39	40	Ground

IR1: IrDA Connector

IR1 is used for an IrDA connector for wireless communication.

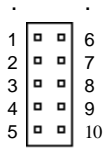

Pin #	Signal Name	Pin #	Signal Name
1	Vcc	6	X
2	X	7	CIRRX
3	IRRX	8	+5VSB
4	Ground	9	X
5	IRTX	10	X

USB1, USB3/4 Connectors

The following table shows the pin outs of the USB connectors.

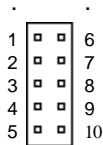

USB1 Pin #	Signal Name	USB1 Pin #	Signal Name
1	Vcc	6	Vcc
2	USBP2N	7	USBP3N
3	USBP2P	8	USBP3P
4	Ground	9	Ground
5	Ground	10	Ground

KB1: PS/2 Keyboard and PS/2 Mouse Connectors

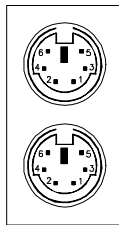

PS/2 Mouse

PS/2 Keyboard

Below are the pin-out assignments of the connectors.

Signal Name	Keyboard	Mouse	Signal Name
Keyboard data	1	1	Mouse data
No Connect	2	2	No Connect
Ground	3	3	No Connect
5V	4	4	5V
Keyboard clock	5	5	Mouse Clock
No Connect	6	6	No Connect

FDD1: Floppy Drive Connector

FDD1 is a 34-pin header and will support up to 2.88MB floppy drives.

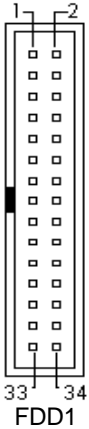

Signal Name	Pin #	Pin #	Signal Name
Ground	1	2	RM/LC
Ground	3	4	No connect
Ground	5	6	No connect
Ground	7	8	Index
Ground	9	10	Motor enable 0
Ground	11	12	Drive select 1
Ground	13	14	Drive select 0
Ground	15	16	Motor enable 1
Ground	17	18	Direction
Ground	19	20	Step
Ground	21	22	Write data
Ground	23	24	Write gate
Ground	25	26	Track 00
Ground	27	28	Write protect
Ground	29	30	Read data
Ground	31	32	Side 1 select
Ground	33	34	Diskette change

LPT1: Parallel Port Connector

J5 is a DB-25 external connector as seen in the previous figure. The following table describes the pin-out assignments of this connector.

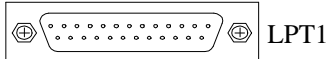

Signal Name	Pin #	Pin #	Signal Name
Line printer strobe	1	14	AutoFeed
PD0, parallel data 0	2	15	Error
PD1, parallel data 1	3	16	Initialize
PD2, parallel data 2	4	17	Select
PD3, parallel data 3	5	18	Ground
PD4, parallel data 4	6	19	Ground
PD5, parallel data 5	7	20	Ground
PD6, parallel data 6	8	21	Ground
PD7, parallel data 7	9	22	Ground
ACK, acknowledge	10	23	Ground
Busy	11	24	Ground
Paper empty	12	25	Ground
Select	13	N/A	N/A

VGA1: VGA CRT Connector

The pin assignments of the VGA1 CRT connector are as follows:

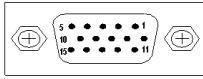

VGA1

Signal Name	Pin	Pin	Signal Name
Red	1	2	Green
Blue	3	4	N.C.
GND	5	6	GND
GND	7	8	GND
N.C.	9	10	GND
N.C.	11	12	N.C.
HSYNC	13	14	VSYNC
NC	15		

COM1, COM2: Serial Ports

COM1 and COM2 both 10-pin header connectors, are the onboard serial ports of the RI7SM. The following table shows the pin assignments of this connector.

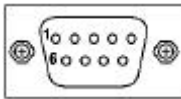

COM1

Pin #	Signal Name
1	DCD, Data carrier detect
2	RXD, Receive data
3	TXD, Transmit data
4	DTR, Data terminal ready
5	GND, ground
6	DSR, Data set ready
7	RTS, Request to send
8	CTS, Clear to send
9	RI, Ring indicator

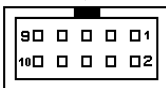

COM2

Pin #	Signal Name
1	DCD, Data carrier detect
2	RXD, Receive data
3	TXD, Transmit data
4	DTR, Data terminal ready
5	GND, ground
6	DSR, Data set ready
7	RTS, Request to send
8	CTS, Clear to send
9	RI, Ring indicator
10	NC

COM3, COM4: Serial Ports

COM3 and COM4 both 10-pin header connectors, are the onboard serial ports of the RI7SM. The following table shows the pin assignments of this connector.

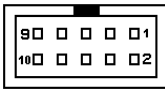

COM3

Pin #	Signal Name	Pin #	Signal Name
1	-HDCD3	6	-HDSR3
2	HSIN3	7	-HRTS3
3	HSOUT3	8	-HCTS3
4	-HDTR3	9	HRI3
5	Ground	10	NC

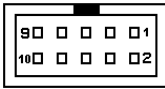

COM4

Pin #	Signal Name	Pin #	Signal Name
1	-HDCD4	6	-HDSR4
2	HSIN4	7	-HRTS4
3	HSOUT4	8	-HCTS4
4	-HDTR4	9	HRI4
5	Ground	10	NC

PCON1: ATX Power Supply Connector

PCON1 is a 20-pin ATX power supply connector. Refer to the following table for the pin out assignments.

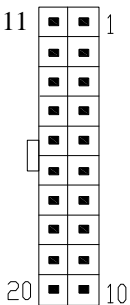

Signal Name	Pin #	Pin #	Signal Name
3.3V	11	1	3.3V
-12V	12	2	3.3V
Ground	13	3	Ground
PS-ON	14	4	+5V
Ground	15	5	Ground
Ground	16	6	+5V
Ground	17	7	Ground
-5V	18	8	Power good
+5V	19	9	5VSB
+5V	20	10	+12V

Watchdog Timer Configuration

The function of the watchdog timer is to reset the system automatically and is defined at WinbonW83627HF. To enable the watchdog timer and allow the system to reset, the timer has a tolerance of 20% for its intervals.

The following example is writing in Intel 8086 assembly language and describes how the timer should be programmed.

The setting Active allows you to select logic device 8.

```
MOV DX, 2EH
MOV AL, 87H
OUT DX, AL
OUT DX, AL
```

```
MOV DX, 2EH
MOV AL, 07H
OUT DX, AL
```

point to Logical Device Number Reg.

```
MOV DX, 2FH
MOV AL, 08H
OUT DX, AL
```

select logical device 8

```
MOV DX, 2EH
MOV AL, 30H
OUT DX, AL
```

select CR30

```
MOV DX, 2FH
MOV AL, 01H
OUT DX, AL
```

update CR30 with value 01H, Active GPIO2

Exit extended function mode

```
MOV DX, 2EH
MOV AL, F5H
OUT DX, AL
```

```
MOV, DX, 2FH
MOV AL, 00L
OUT DX, AL
```

Noted: In minutes setting function, it is recommended that this value number is 08; In seconds setting function, it is recommended that this value number is 00.

```
MOV DX, 2EH
MOV AL, F6H
OUT DX, AL
```

```
MOV, DX, 2F
MOV AL, 05
OUT DX, AL
```

Noted: To get enable message, you can choose the values from 1; By the same token, to get disable message, you can select the values from 0.

To setup watchdog timer function by debug.exe file, you can consult the sample setting from this table.

WATCHDOG TIMER CONTROL TABLE

Level	Value	Time/sec
0	0	Disable
1	1	0.5
2	2	1.5
3	3	2.5
4	4	3.5
5	5	4.5
6	6	5.5
.	.	.
.	.	.
255	255	254.5

Chapter 3

BIOS Configuration

This chapter describes the different settings available in the Award BIOS that comes with the CPU card. The topics covered in this chapter are as follows:

BIOS Introduction	31
BIOS Setup.....	31
Standard CMOS Setup.....	33
Date.....	33
Time.....	34
Primary HDDs / Secondary HDDs	34
Drive A / Drive B	35
Video.....	35
Halt On	35
Advanced BIOS Features Setup	36
Virus Warning.....	36
CPU Internal Cache / External Cache.....	36
CPU L2 Cache ECC Checking.....	36
Processor Number Feature	36
Quick Power On Self Test.....	37
First Boot device.....	37
Second Boot device	37
Third Boot device	37
Swap Floppy Drive	37
Boot Up Floppy Seek	37
Boot Up NumLock Status	37
Gate A20 Option	37
Gate A20 Option	37
Typematic Rate Setting.....	37

Typematic Rate (Chars/Sec)	37
Typematic Delay (Msec).....	38
Security Option	38
OS Select for DRAM > 64MB.....	38
Report No FDD for Win95	38
Video BIOS Shadow	39
C8000-CBFFF Shadow/DC000-DFFFF Shadow.....	39
Advanced Chipset Features Setup.....	39
SDRAM CAS Latency Time	39
SDRAM Cycle Time Tras/Trc	39
SDRAM RAS-to-CAS Delay.....	40
SDRAM RAS Precharge Time	40
System BIOS Cacheable.....	40
Video BIOS Cacheable.....	40
Memory Hole at 15MB - 16MB.....	40
CPU Latency Timer.....	40
Delayed Transaction.....	40
AGP Graphics Aperture Size	40
Display Cache Frequency	41
System Memory Frequency.....	41
On-Chip Video Window Size	41
Onboard Display Cache Setting.....	41
CAS# Latency.....	42
Paging Mode Control	42
RAS-to-CAS Override.....	42
RAS# Timing.....	42
RAS# Precharge Timing	42
Integrated Peripherals	42
OnChip Primary PCI IDE	42
OnChip Secondary PCI IDE	42
IDE Primary Master PIO.....	42
IDE Primary Slave PIO	42
IDE Scondary Master PIO.....	42
IDE Secondary Slave PIO.....	42
IDE Primary Master UDMA.....	42
IDE Primary Slave UDMA.....	42
IDE Scondary Master UDMA.....	42
IDE Secondary Slave UDMA	42
USB Controller	42
USB Keyboard Support	43
USB Mouse Support.....	43
Init Display First	43

AC97 Audio	43
IDE HDD Black Mode.....	43
IDE HDD Black Mode.....	43
Power On Function	43
KB Power On Passward.....	43
Hot Key Power On.....	43
Onboard FDC Controller	43
Onboard Serial Port.....	44
Onboard Parallel Port.....	44
UART Mode Select	44
RxD, TxD Active	44
IR Transmission Delay	44
UR2 Duplex Mode	44
Use IR Pins.....	44
Onboard Parallel Port.....	44
EPP Mode Select	44
ECP Mode Use DMA	44
Onboard Parallel Port.....	44
PWRON After PW-Fail	44
Game Port Address	44
Midi Port Address	44
Midi Port IRQ	44
Onboard Serial Port 3	45
Sereial Port 3 Use IRQ.....	45
Onboard Serial Port 4.....	45
Sereial Port 4 Use IRQ	45
Power Management Setup.....	46
ACPI Function	46
ACPI Suspend Tpye.....	46
Power Supply Type.....	46
Power Management.....	46
Video Off Method.....	47
Video Off In Suspend	47
Suspend Type	47
Modem Use IRQ.....	47
Suspend Mode	47
HDD Power Down	47
Soft-Off by PWR-BTTN	47
Wake-Up by PCI Card	47
PWR On by Ring.....	48
CPU Thermal-Throtting	48
Resume by Alarm	48

Reload Global Timer Events.....	48
Primary IDE 0.....	48
Primary IDE1.....	48
Secondary IDE 0.....	48
Secondary IDE 1.....	48
FDD, COM, LPT Port.....	48
PCI PIRQ(A-D)#.....	48
PNP/PCI Configuration.....	49
PNP OS Installed.....	49
Reset Configuration Data.....	49
ResourcesController by.....	49
IRQ Resources/DMA Resources.....	49
PCI/VGA Palette Snoop.....	50
PC Health Status.....	50
CPU Warning Temperature.....	50
Current System Temp.....	50
Current CPU1 Temperature.....	50
Current CPU1FAN1 Speed.....	50
Current CPU1FAN2 Speed.....	50
INO (V).....	50
IN1 (V).....	50
IN2 (V).....	50
+5V.....	50
+12V.....	50
-12V.....	50
-5V.....	50
VBAT(V).....	50
5VSB(V).....	50
Shutdown Temperature.....	51
Frequency/Voltage Control.....	51
Auto Detect DIMM/PCI Clk.....	51
CPU Clock Spectrum.....	51
CPU HOST/PCI Clock/PC133.....	51
CPU Clock Ratio.....	51
Load Fial-Safe/Optimized Defaults.....	52
Set Supervisor / User Password.....	53
Save & Exit Setup.....	53
Exit Without Saving.....	54

BIOS Introduction

The Award BIOS (Basic Input/Output System) installed in your computer system's ROM supports Intel Pentium II processors in a standard IBM-AT compatible I/O system. The BIOS provides critical low-level support for a standard device such as disk drives, serial ports and parallel ports. It also adds virus and password protection as well as special support for detailed fine-tuning of the chipset controlling the entire system.

BIOS Setup

The Award BIOS provides a Setup utility program for specifying the system configurations and settings. The BIOS ROM of the system stores the Setup utility. When you turn on the computer, the Award BIOS is immediately activated. Pressing the key immediately allows you to enter the Setup utility. If you are a little bit late pressing the key, POST (Power On Self Test) will continue with its test routines, thus preventing you from invoking the Setup. If you still wish to enter Setup, restart the system by pressing the "Reset" button or simultaneously pressing the <Ctrl>, <Alt> and <Delete> keys. You can also restart by turning the system Off and back On again. The following message will appear on the screen:

```
Press <DEL> to Enter Setup
```

In general, you press the arrow keys to highlight items, <Enter> to select, the <PgUp> and <PgDn> keys to change entries, <F1> for help and <Esc> to quit.

When you enter the Setup utility, the Main Menu screen will appear on the screen. The Main Menu allows you to select from various setup functions and exit choices.

CMOS SETUP UTILITY-Copyright (C) 1984-2001

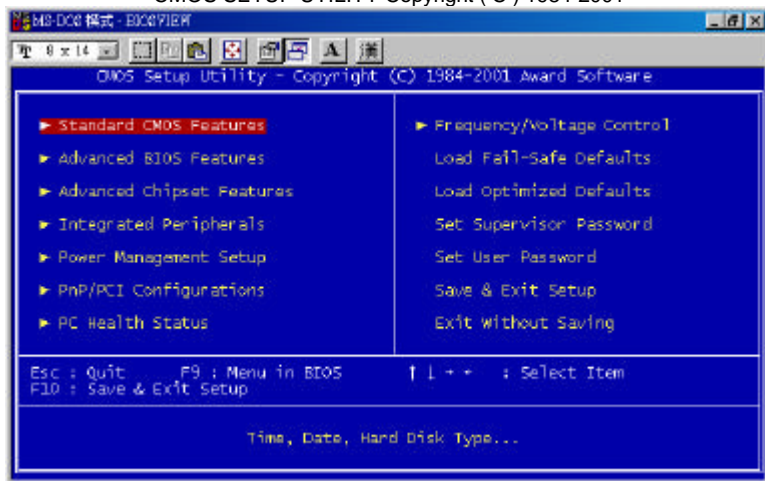

The section below the setup items of the Main Menu displays the control keys for this menu. At the bottom of the Main Menu just below the control keys section, there is another section which displays information on the currently highlighted item in the list.

NOTE: *If your computer cannot boot after making and saving system changes with Setup, the Award BIOS supports an override to the CMOS settings that resets your system to its default.*

We strongly recommend that you avoid making any changes to the chipset defaults. These defaults have been carefully chosen by both Award and your system manufacturer to provide the absolute maximum performance and reliability.

Standard CMOS Setup

The “Standard CMOS Setup” choice allows you to record some basic hardware configurations in your computer system and set the system clock and error handling. If the motherboard is already installed in a working system, you will not need to select this option. You will need to run the Standard CMOS option, however, if you change your system hardware configurations, the onboard battery fails, or the configuration stored in the CMOS memory was lost or damaged.

CMOS Setup Utility – Copyright (C) 1984-2001
STANDARD CMOS SETUP
AWARD BIOS INC.

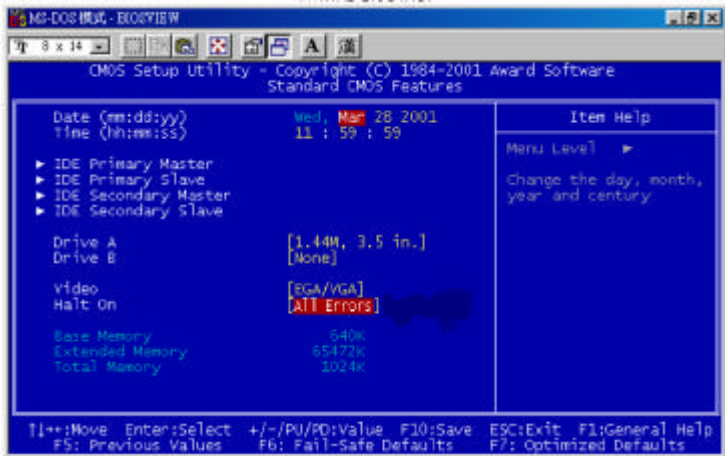

At the bottom of the menu are the control keys for use on this menu. If you need any help in each item field, you can press the <F1> key. It will display the relevant information to help you. The memory display at the lower right-hand side of the menu is read-only. It will adjust automatically according to the memory changed. The following describes each item of this menu.

Date

The date format is:

Day : Sun to Sat
Month : 1 to 12
Date : 1 to 31
Year : 1994 to 2079

To set the date, highlight the “Date” field and use the PageUp/PageDown or +/- keys to set the current time.

Time

The time format is: **Hour : 00 to 23**
Minute : 00 to 59
Second : 00 to 59

To set the time, highlight the “Time” field and use the <PgUp>/<PgDn> or +/- keys to set the current time.

Primary HDDs / Secondary HDDs

The onboard PCI IDE connectors provide Primary and Secondary channels for connecting up to four IDE hard disks or other IDE devices. Each channel can support up to two hard disks; the first is the “Master” and the second is the “Slave”.

To enter the specifications for a hard disk drive, you must select first a “Type”. There are 45 predefined types and 4 user definable types are for Enhanced IDE BIOS. Type from 1 to 45 are predefined. Type “User” is user-definable. For the Primary Master/Slave as well as Secondary Master/Slave, you can select “Auto” under the TYPE and MODE fields. This will enable auto detection of your IDE drives and CD-ROM drive during POST.

Press <PgUp>/<PgDn> to select a numbered hard disk type or type the number and press the <Enter> key. The hard disk will not work properly if you enter incorrect information for this field. If your hard disk drive type is not matched or listed, you can use Type User to define your own drive type manually. If you select Type User, related information is asked to be entered to the following items.

CYLS : Number of cylinders
HEAD : Number of read/write heads
PRECOMP : Write precompensation
LANDZ : Landing zone
SECTOR : Number of sectors
SIZE : Automatically adjust according to the configuration
MODE (for IDE HDD only) : Auto
 Normal (HD < 528MB)
 Large (for MS-DOS only)
 LBA (HD > 528MB and supports
 Logical Block Addressing)

NOTE: *The specifications of your drive must match with the drive table. The hard disk will not work properly if you enter incorrect information in these fields. If your hard disk drive type is not matched or listed, you can use Type User to define your own drive type manually.*

Drive A / Drive B

These fields identify the types of floppy disk drive A or drive B that has been installed in the computer. The available specifications are:

360KB	1.2MB	720KB	1.44MB	2.88MB
5.25 in.	5.25 in.	3.5 in.	3.5 in.	3.5 in.

Video

This field selects the type of video display card installed in your system. You can choose the following video display cards:

EGA/VGA	For EGA, VGA, SEGA, SVGA or PGA monitor adapters. (default)
CGA 40	Power up in 40 column mode.
CGA 80	Power up in 80 column mode.
MONO	For Hercules or MDA adapters.

Halt On

This field determines whether the system will halt if an error is detected during power up.

No errors	The system boot will not be halted for any error that may be detected.
All errors	Whenever the BIOS detects a non-fatal error, the system will stop and you will be prompted (default).
All, But Keyboard	The system boot will not be halted for a keyboard error; it will stop for all other errors
All, But Diskette	The system boot will not be halted for a disk error; it will stop for all other errors.
All, But Disk/Key	The system boot will not be halted for a keyboard or disk error; it will stop for all others.

Advanced BIOS Features

This section allows you to configure and improve your system and allows you to set up some system features according to your preference.

Figure 1.

CMOS Setup – Copyright (C) 1984-2001
Advanced Chipset Feature Setup
AWARD SOFTWARE, INC.

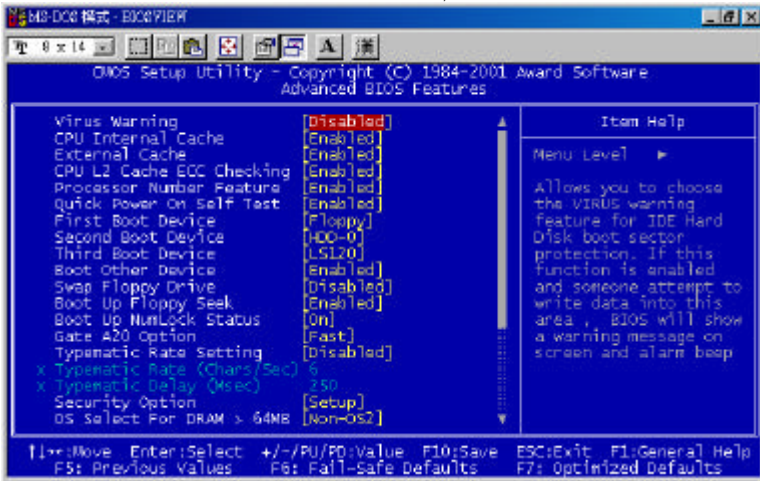

Virus Warning

This item protects the boot sector and partition table of your hard disk against accidental modifications. If an attempt is made, the BIOS will halt the system and display a warning message. If this occurs, you can either allow the operation to continue or run an anti-virus program.

CPU Internal Cache / External Cache

When the CPU requests data, the system transfers the requested data from the main DRAM into cache memory, for even faster access by the CPU. These items allow you to enable (speed up memory access) or disable the cache function. By default, these items are *Enabled*.

CPU L2 Cache ECC Checking

When enabled, this allows ECC checking of the CPU's L2 cache. By default, this field is *Enabled*.

Processor Number Feature

This field only appears if the processor on board is a Pentium III processor. The Processor Number Feature can be enabled or disabled.

Quick Power On Self Test

When enabled, this field speeds up the Power On Self Test (POST) after the system is turned on. If it is set to *Enabled*, BIOS will skip some items.

First/Second/Third Boot Device

These fields determine the drive that the system searches first for an operating system. The options available include *Floppy*, *LS/ZIP*, *HDD-0*, *SCSI*, *CDROM*, *HDD-1*, *HDD-2*, *HDD-3*, *LAN* and *Disable*.

Boot Other Device

These fields allow the system to search for an operating system from other devices other than the ones selected in the First/Second/Third Boot Device.

Swap Floppy Drive

This item allows you to determine whether or not to enable Swap Floppy Drive. When enabled, the BIOS swaps floppy drive assignments so that Drive A becomes Drive B, and Drive B becomes Drive A. By default, this field is set to *Disabled*.

Boot Up Floppy Seek

When enabled, the BIOS will seek whether or not the floppy drive installed has 40 or 80 tracks. 360K type has 40 tracks while 760K, 1.2M and 1.44M all have 80 tracks. By default, this field is set to *Enabled*.

Boot Up NumLock Status

This allows you to activate the NumLock function after you power up the system. By default, the system boots up with *NumLock On*.

Gate A20 Option

This field allows you to select how Gate A20 is worked. Gate A20 is a device used to address memory above 1 MB.

Typematic Rate Setting

When disabled, continually holding down a key on your keyboard will generate only one instance. When enabled, you can set the two typematic controls listed next. By default, this field is set to *Disabled*.

Typematic Rate (Chars/Sec)

When the typematic rate is enabled, the system registers repeated keystrokes speeds. You can select speed range from 6 to 30 characters per second. By default, this item is set to **6**.

Figure 2.

CMOS Setup – Copyright (C) 1984-2001
Advanced Chipset Feature Setup
AWARD SOFTWARE, INC.

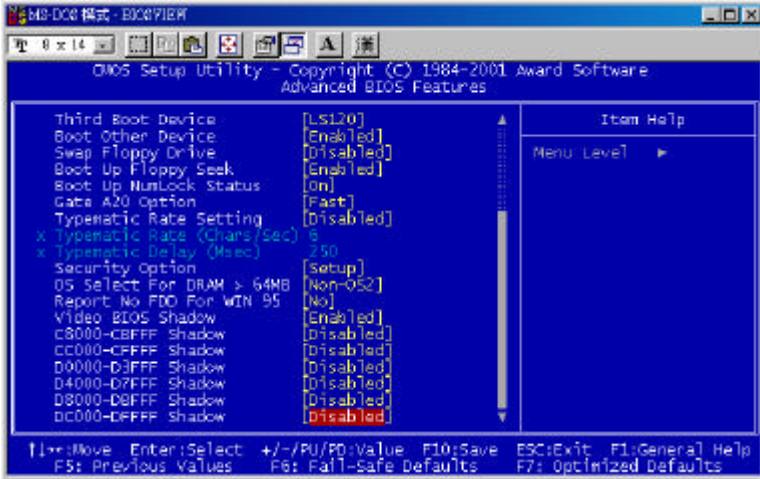

Typematic Delay (Msec)

When the typematic rate is enabled, this item allows you to set the time interval for displaying the first and second characters. By default, this item is set to **250msec**.

Security Option

This field allows you to limit access to the System and Setup. The default value is **Setup**. When you select **System**, the system prompts for the User Password every time you boot up. When you select **Setup**, the system always boots up and prompts for the Supervisor Password only when the Setup utility is called up.

OS Select for DRAM > 64MB

This option allows the system to access greater than 64MB of DRAM memory when used with OS/2 that depends on certain BIOS calls to access memory. The default setting is **Non-OS/2**.

Report No FDD For WIN 95

This option allows Windows 95 to share with other peripherals IRQ6 which is assigned to a floppy disk drive if the drive is not existing. The default setting is **No**

Video BIOS Shadow

This item allows you to change the Video BIOS location from ROM to RAM. Video Shadow will increase the video speed.

C8000 - CBFFF Shadow/DC000 - DFFFF Shadow

Shadowing a ROM reduces the memory available between 640KB to 1024KB. These fields determine whether or not optional ROM will be copied to RAM.

Advanced Chipset Features

This Setup menu controls the configuration of the motherboard chipset.
Figure 1.

CMOS Setup Utility – Copyright (C) 1984-2001
Advanced CHIPSET FEATURES
AWARD SOFTWARE INC.

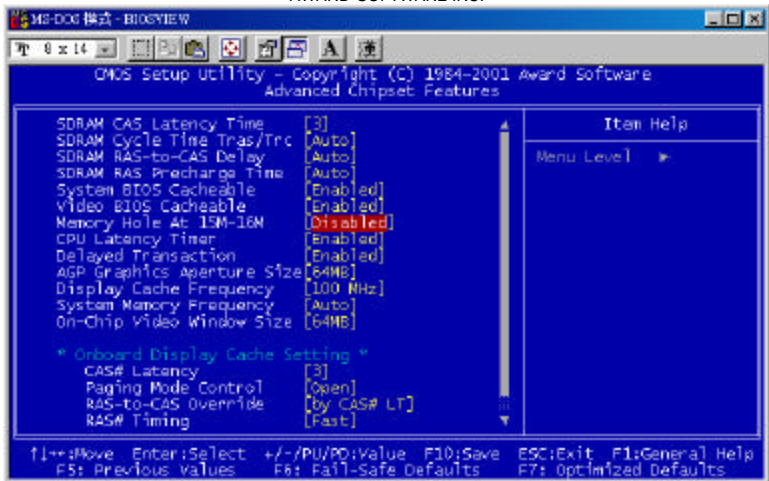

SDRAM CAS Latency Time

You can select CAS latency time in HCLKs of 2/2 or 3/3. The system board designer should set the values in this field, depending on the DRAM installed. Do not change the values in this field unless you change specifications of the installed DRAM or the installed CPU. The choices are 2 and 3.

SDRAM Cycle Time Trns/Trc

The settings available for the SDRAM Cycle Time Trns/Trc are 7/9, 5/7 and Auto. The default setting is 7/9.

SDRAM RAS-to-CAS Delay

You can select RAS to CAS Delay time in HCLKs of 2/2 or 3/3. The system board designer should set the values in this field, depending on the DRAM installed. Do not change the values in this field unless you change specifications of the installed DRAM or the installed CPU. The choices are **2**, **3** and *Auto*. The default setting is **3**.

SDRAM RAS Precharge Time

This option defines the length of time for Row Address Strobe is allowed to precharge. The choices are **2** and **3**.

System BIOS Cacheable

The setting of *Enabled* allows caching of the system BIOS ROM at F000h-FFFFh, resulting in better system performance. However, if any program writes to this memory area, a system error may result.

Video BIOS Cacheable

The Setting *Enabled* allows caching of the video BIOS ROM at C0000h-F7FFFh, resulting in better video performance. However, if any program writes to this memory area, a system error may result.

Memory Hole At 15M-16M

In order to improve performance, certain space in memory can be reserved for ISA cards. This memory must be mapped into the memory space below 16 MB. The choices are *Enabled* and *Disabled*.

CPU Latency Timer

This field enable or disable the CPU latency timer. The default setting is *Enabled*.

Delayed Transaction

The chipset has an embedded 32-bit posted write buffer to support delay transactions cycles. Select *Enabled* to support compliance with PCI specification version 2.1.

AGP Graphics Aperture Size

The field sets aperture size of the graphics. The aperture is a portion of the PCI memory address range dedicated for graphics memory address space. Host cycles that hit the aperture range are forwarded to the AGP without any translation. The options available are 32M and 64M. The default setting is **64M**.

Display Cache frequency

The Frequency setting available for this item are 100MHz, 133MHz and Auto. The default setting is 100MHz.

System Memory frequency

The Frequency setting available for this item are 100MHz, 133MHz and Auto. The default setting is Auto.

On-Chip Video Window Size

The setting choices for the On-Chip Video Window Size are *64MB* and *Disable*. By default, this option is set to **64MB**.

Onboard Display Cache Setting

The default setting and optional setting for the onboard display cache functions are as follows:

CAS# Latency	3(default), 2(option)
Paging Mode Control	Open (default), Close (option)
RAS-to-CAS Override	by CAS# LT (default), Override (2)(option)
RAS# Timing	Fast (default), Slow (option)
RAS# Precharge Timing	Fast (default), Slow (option)

CMOS Setup Utility – Copyright (C) 1984-2001
ADVANCED CHIPSET FEATURES
AWARD SOFTWARE INC.



Integrated Peripherals

This option sets your hard disk configuration, mode and port.

CMOS Setup Utility – Copyright (C) 1984-2001
INTEGRATED PERIPHERAL
AWARD SOFTWARE INC.

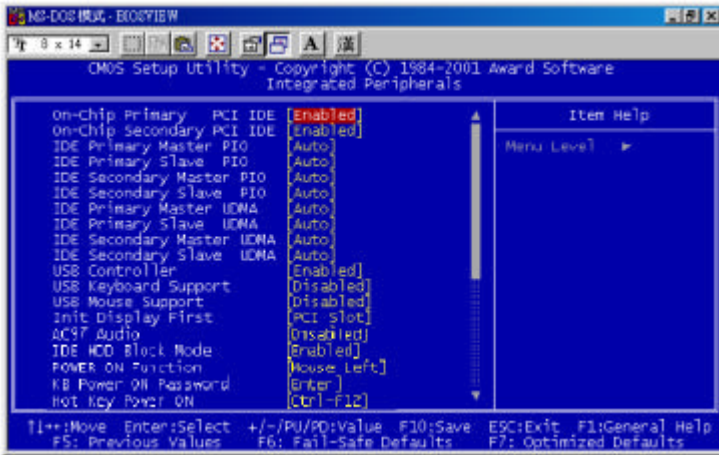

On-Chip Primary/Secondary PCI IDE

The integrated peripheral controller contains an IDE interface with support for two IDE channels. Select *Enabled* to activate each channel separately.

IDE Primary/Secondary Master/Slave PIO

These fields allow your system hard disk controller to work faster. Rather than have the BIOS issue a series of commands that transfer to or from the disk drive, PIO (Programmed Input/Output) allows the BIOS to communicate with the controller and CPU directly.

The system supports five modes, numbered from 0 (default) to 4, which primarily differ in timing. When *Auto* is selected, the BIOS will select the best available mode.

IDE Primary/Secondary Master/Slave UDMA

These fields allow your system to improve disk I/O throughput to 33Mb/sec with the Ultra DMA/33 feature. The options are *Auto* and *Disabled*.

USB Controller

The options for this field are *Enabled* and *Disabled*. By default, this field is set to *Enabled*.

USB Keyboard Support

Select *Enabled* if your system contains a Universal Serial Bus (USB) controller and you have a USB keyboard.

USB Mouse Support

Select *Enabled* if your system contains a Universal Serial Bus (USB) controller and you have a USB mouse.

Init Display First

This field allows the system to initialize first the VGA card on chip or the display on the PCI Slot. By default, the *PCI Slot* VGA is initialized first.

AC'97 Audio

The options for this field are *Auto* and *Disabled*. Default setting is *Auto*.

IDE HDD Block Mode

This field allows your hard disk controller to use the fast block mode to transfer data to and from your hard disk drive.

Power on Function

It offers many options to setup at the Power On Function. There are *Hot Key*, *Mouse Left*, *Mouse Right*, *Any Key*, *Button Only*, *Keyboard 98* and *Password* to select. The default setting is *Button Only*.

KB Power On Password

Type correct password with keyboard. The default setting is *Enter*.

Hot Key Power on

Users can select the function they want from *Ctrl+F1* to *Ctrl+F12* with *Hot Key Power On* function setting.

Onboard FDC Controller

Select *Enabled* if your system has a floppy disk controller (FDC) installed on the system board and you wish to use it. If you install an add-in FDC or the system has no floppy drive, select *Disabled* in this field. This option allows you to select the onboard FDD port.

Onboard Serial/Parallel Port

These fields allow you to select the onboard serial and parallel ports and their addresses. The default values for these ports are:

Serial Port 1	3F8/IRQ4
Serial Port 2	2F8/IRQ3
Parallel Port	378H/IRQ7

UART Mode Select

This field determines the UART mode in your computer. The settings are *Normal*, *IrDA* and *ASKIR*. The default value is *Normal*.

RxD, TxD Active

The settings for this field are *Hi,Lo*, *Lo,Hi*, *Lo,Lo*, and *Hi,Hi*.

IR Transmission Delay

By default, this field is set to *Enabled*.

UR2 Duplex Mode

The settings available for this field are *Half* (default) and *Full*.

Use IR Pins

The settings for this field are *IR*, *Rx2Tx2* (default) and *RxD2, TxD2*.

Onboard Parallel Port

The setting for this field are *378/IRQ7*, *278/IRQ5*, *2BC/IRA7* and *Disabled*. By default, the onboard parallel port is set to *378/IRQ7*.

Parallel Port Mode/ EPP Mode/ ECP Mode Use DMA

This field allows you to determine parallel port mode function.

SPP	Normal Printer Port (Default)
EPP	Enhanced Parallel Port, default setting is <i>EPP</i>
1.7	
ECP	Extended Capabilities Port, default setting is <i>3</i>

PWRON After PW-Fail

In case of power failure, the system can be configured to power on or to remain off when the power returns. These two settings are *Former-Sts* and *Off* respectively. The default setting for this field is *Off*.

Game Port Address

The option settings for this field are *201*, *209* and *Disabled*. The default setting is *201*.

Midi Port Address

The option settings for this field are *330*, *400* and *Disabled*. The default setting is *330*.

Midi Port IRQ

The option settings for this field are *5* and *10*. The default setting is *5*.

Onboard Serial Port 3

The settings for this field are *3F8H*, *2F8H*, *3E8H*, *2E8H* and *Disabled*. By default, the onboard parallel port is set to *3E8H*.

Serial Port 3 use IRQ

The option settings for this field are *5*, *4*, *3*, *10* and *11*. The default setting is *5*.

Onboard Serial Port 4

The settings for this field are *3F8H*, *2F8H*, *3E8H*, *2E8H* and *Disabled*. By default, the onboard parallel port is set to *2E8H*.

Serial Port 4 use IRQ

The option settings for this field are *5*, *4*, *3*, *10* and *11*. The default setting is *11*.

CMOS Setup Utility – Copyright (C) 1984-2001
INTEGRATED PERIPHERIAL
AWARD SOFTWARE INC.

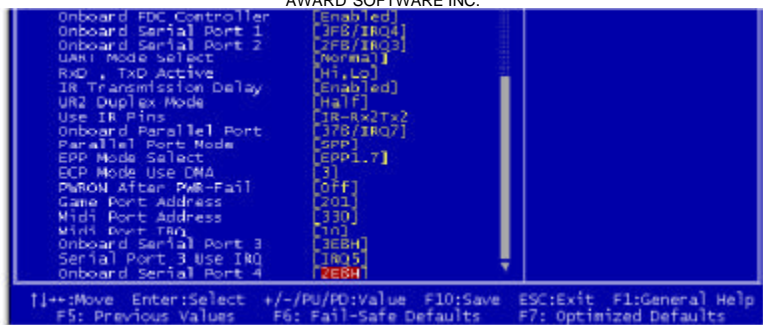

Power Management Setup

The Power Management Setup allows you to save energy of your system effectively. It will shut down the hard disk and turn off video display after a period of inactivity.

ROM PCI/ISA BIOS
POWER MANAGEMENT SETUP
AWARD SOFTWARE, INC.

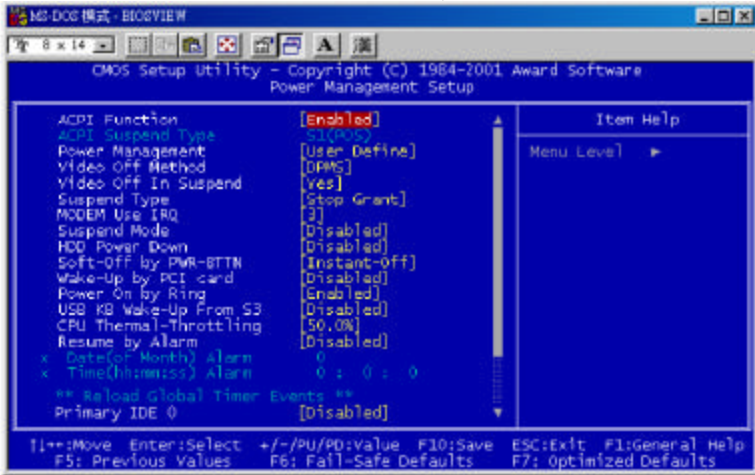

ACPI Function

This Item allows you to Enabled/Disabled the Advanced Configuration Power Management (ACPI). The settings are Enabled and Disabled.

ACPI Suspend Type

The options for the ACPI Suspend Type field is *S1(POS)*

Power Management

This field allows you to select the type of power saving management modes. There are four selections for Power Management.

- | | |
|-------------------|--|
| Min. Power Saving | Minimum power management |
| Max. Power Saving | Maximum power management. |
| User Define | Each of the ranges is from 1 min. to 1hr.
Except for HDD Power Down which ranges
from 1 min. to 15 min.
(Default) |

NOTE: In order to enable the CPU overheat protection feature, the Power Management field should not be set to Disabled.

Video Off Method

This field defines the Video Off features. There are three options.

V/H SYNC + Blank, blank the screen and turn off vertical and horizontal scanning.

DPMS Allows the BIOS to control the video display card if it supports the DPMS feature. (Default)

Blank Screen This option only writes blanks to the video buffer.

Video Off In Suspend

This determines the manner in which the monitor is blanked. The settings are: Yes and No.

Suspend Type

Select the Suspend Type. The settings are: PWRON Suspend, Stop Grant

Modem Use IRQ

This field names the interrupt request (IRQ) line assigned to the modem (if any) on your system. Activity of the selected IRQ always awakens the system. By default, the IRQ is set to 3.

Suspend Mode

When enabled, and after the set time of system inactivity, all devices except the CPU will be shut off.

HDD Power Down

When enabled, and after the set time of system inactivity, the hard disk drive will be powered down while all other devices remain active.

Soft-Off by PWR-BTTN

This field defines the power-off mode when using an ATX power supply. The Instant-Off mode allows powering off immediately upon pressing the power button. In the Delay 4 Sec mode, the system powers off when the power button is pressed for more than four seconds or places the system in a very low-power-usage state, with only enough circuitry receiving power to detect power button activity or Resume by Ring activity (see next field) when pressed for less than 4 seconds. The default value is *Instant-Off*.

Wake-Up by PCI Card

When *Disable*, use PCI card to operate Wake On LAN function.

PWR On by Ring

An input signal on the serial Ring Indicator (RI) line (in other words, an incoming call on the modem) awakens the system from a soft off state.

CPU Thermal-Throttling

The CPU Thermal Throttling function, by default, is set to 62.5%

Resume by Alarm

This field enables or disables the resumption of the system operation. When enabled, the user is allowed to set the *Date* and *Time*.

Reload Global Timer Events

The HDD, FDD, COM, LPT Ports and PCI PIRQ are I/O events which can prevent the system from entering a power saving mode or can awaken the system from such a mode. When an I/O device wants to gain the attention of the operating system, it signals by causing an IRQ to occur. When the operating system is ready to respond to the request, it interrupts itself and performs the service.

Figurer 2

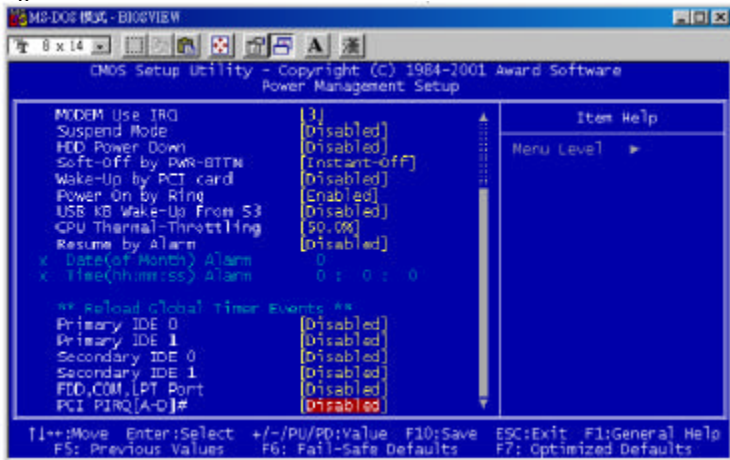

PNP/PCI Configuration

This option configures the PCI bus system. All PCI bus systems on the system use INT#, thus all installed PCI cards must be set to this value.

ROM PCI/ISA BIOS
PNP/PCI CONFIGURATION
AWARD SOFTWARE INC.

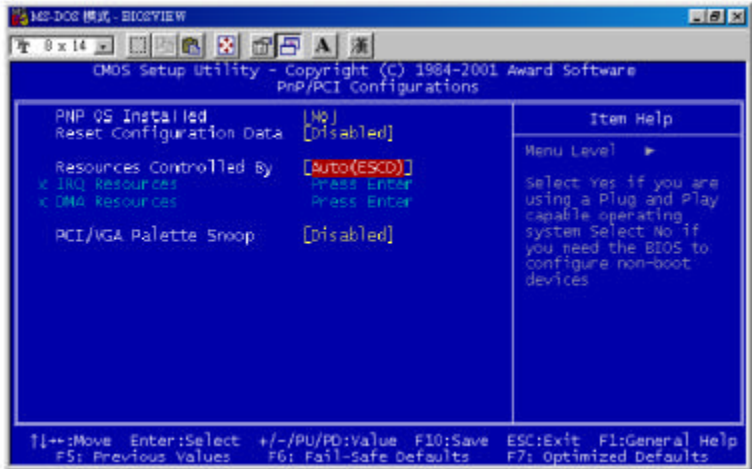

PNP OS Installed

This field allows you to specify if the operating system installed in your system is plug and play aware.

Reset Configuration Data

This field allows you to determine whether or not to reset the configuration data. The default value is *Disabled*.

Resources Controlled by

This PnP BIOS can configure all of the boot and compatible devices automatically. However, this capability needs you to use a PnP operating system such as Windows 95. The default value is *Auto(ESCD)*.

Auto(ESCD)/Manual

Every peripheral device has a node which is called ESCD. This node records which resource is assigned to it. The system needs to record and update ESCD to the memory locations. Default setting is *Auto(ESCD)*.

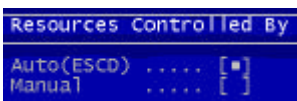

PCI / VGA Palette Snoop

Leave this field at Disabled. These settings are Enabled, Disabled.

PC Health Status

This section presents the States of your CPU, Fan, Warning for overall system status.

CMOS Setup Utility – Copyright (C) 1984-2001 Award Software
PC Health Status
AWARD SOFTWARE INC.

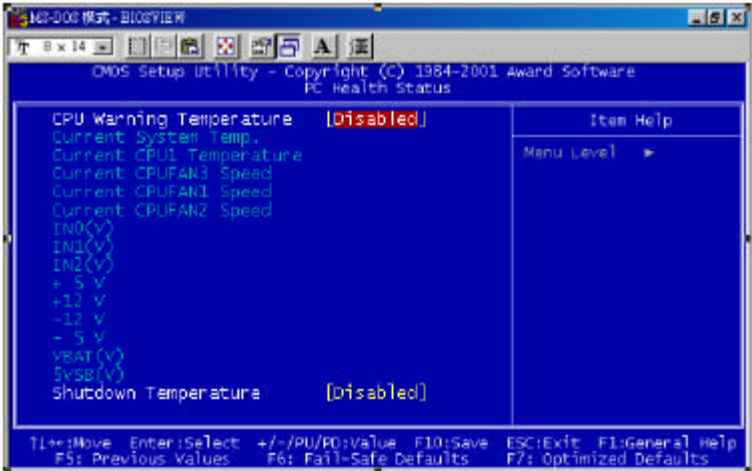

CPU Warning Temperature

During Enabled, this will warn the user when the CPU temperature reach a certain temperature.

Temperatures/Fan Speeds/Voltages

These fields are the parameters of the hardware monitoring function feature of the motherboard. The values are read-only values as monitored by the system and show the PC health status.

Shutdown Temperature

This option is for setting the Shutdown temperature level for the processor. When the processor reaches the temperature you set, this will shutdown the system.

Frequency/ Voltage Control

This section is for setting CPU Frequency/ Voltage Control.

CMOS Setup Utility – Copyright (C) 1984-2001 Award Software
Frequency / Voltage Control
AWARD SOFTWARE INC.

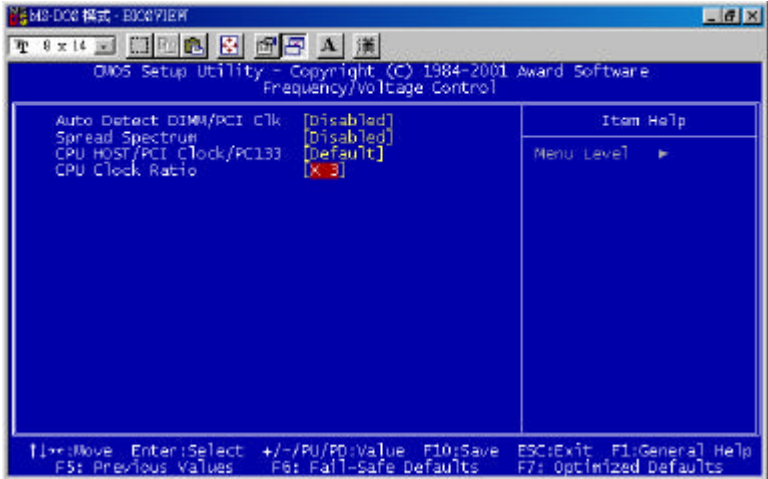

Auto Detect DIMM/PCI Clk

This item allows you to enable/disable auto detect DIMM/PCI Clock. The setting are: Enabled / Disabled.

Spread Spectrum

This item allows you to set the CPU Clock / Spread Spectrum.

CPU Host /PCI Clock/PC133

The CPU Host /PCI Clock/PC133 has the setting of *Default* which supports 133MHz only or above by the system.

CPU Clock Ratio

The CPU Ratio, also known as the CPU bus speed multiplier, can be configured as 3, 3.5, 4, 4.5, 5, 5.5, 6, 6.5, 7, 7.5, and 8.

Load Fail-Safe Defaults

This option allows you to load the troubleshooting default values permanently stored in the BIOS ROM. These default settings are non-optimal and disable all high-performance features.

Load Fail-Safe Defaults Setup Utility – Copyright © 1984-2001 Award Software

Standard CMOS Features	Frequency/Voltage Control
Advanced BIOS Features	Load Fail-Safe Defaults
Advanced Chipset Features	Load Optimized Defaults
Integrated Peripherals	Set Supervisor Password
Power Management Setup	Set User Password
PnP/PCI Configurations	Save & Exit Setup
PC Health Status	Exit Without Saving
ESC : Quit	↑ ↓ → ← : Select Item
F10 : Save & Exit Setup	

Load Optimized Defaults

This option allows you to load the default values to your system configuration. These default settings are optimal and enable all high performance features.

Load Optimized Defaults Setup Utility – Copyright © 1984-2001 Award Software

Standard CMOS Features	Frequency/Voltage Control
Advanced BIOS Features	Load Fail-Safe Defaults
Advanced Chipset Features	Load Optimized Defaults
Integrated Peripherals	Set Supervisor Password
Power Management Setup	Set User Password
PnP/PCI Configurations	Save & Exit Setup
PC Health Status	Exit Without Saving
ESC : Quit	↑ ↓ → ← : Select Item
F10 : Save & Exit Setup	

Set Supervisor / User Password

These two options set the system password. *Supervisor Password* sets a password that will be used to protect the system and Setup utility. *User Password* sets a password that will be used exclusively on the system. To specify a password, highlight the type you want and press <Enter>. The **Enter Password:** message prompts on the screen. Type the password, up to eight characters in length, and press <Enter>. The system confirms your password by asking you to type it again. After setting a password, the screen automatically returns to the main screen. To disable a password, just press the <Enter> key when you are prompted to enter the password. A message will confirm the password to be disabled. Once the password is disabled, the system will boot and you can enter Setup.

Set Supervisor / User Password Utility – Copyright © 1984-2001 Award Software

Standard CMOS Features	Frequency/Voltage Control
Advanced BIOS Features	Load Fail-Safe Defaults
Advanced Chipset Features	Load Optimized Defaults
Integrated Peripherals	Set Supervisor Password
Power Management	Enter Password:
PnP/PCI Configuration	
PC Health Status	
ESC : Quit	↑ ↓ → ← : Select Item
F10 : Save & Exit Setup	

Save & Exit Setup

This option allows you to determine whether to accept the modifications or not. If you type “Y”, you will quit the setup utility and save all changes into the CMOS memory. If you type “N”, you will return to Setup utility.

Save & Exit Setup Utility – Copyright © 1984-2001 Award Software

Standard CMOS Features	Frequency/Voltage Control
Advanced BIOS Features	Load Fail-Safe Defaults
Advanced Chipset Features	Load Optimized Defaults
Integrated Peripherals	Set Supervisor Password
Power Management	Save to CMOS and Exit (Y/N)? N
PnP/PCI Configuration	
PC Health Status	Exit Without Saving
ESC : Quit	↑ ↓ → ← : Select Item
F10 : Save & Exit Setup	

Exit Without Saving

Select this option to exit the Setup utility without saving the changes you have made in this session. Typing “Y” will quit the Setup utility without saving the modifications. Typing “N” will return you to Setup utility.

Exit Without Saving Utility – Copyright © 1984-2001 Award Software

Standard CMOS Features	Frequency/Voltage Control
Advanced BIOS Features	Load Fail-Safe Defaults
Advanced Chipset Features	Load Optimized Defaults
Integrated Peripherals	Set Supervisor Password
Power Management	ord
PnP/PCI Conf	o
PC Health Stat	ng
ESC : Quit	↑ ↓ → ← : Select Item
F10 : Save & Exit Setup	

Quit Without Saving (Y/N)? N

Chapter 4

815E Chipset Driver Installation Guide

This chapter provides information on how to install the 815E Chipset Driver that comes in this driver CD with the package. Please follow the instructions set forth in this chapter carefully. Please note that this 815E Chipset Driver must be installed in your system first before you could proceed to install the relevant drivers.

The following items are covered in this chapter:

Installing the Drivers for Windows 98SE	56
Installing the Drivers for Windows 2000	56

Installing the 815E Chipset Drivers for Windows 98SE Windows 2000

The following section describes the 815E Chipset driver installation procedures for Windows 98SE and Windows 2000.

- Step 1:** Insert driver CD into CD-ROM.
- Step 2:** Click **Server**.
- Step 3:** Click **RI7SM**.
- Step 4:** Click **Intel 815, 815E Chipset Driver**.
- Step 5:** Click **Next**.
- Step 6:** Click **Yes**.
- Step 7:** Click **Next**.
- Step 8:** Click **Finish**. You must restart your computer now.

Chapter 5

VGA Driver Installation Guide

This chapter provides information on how to install VGA drivers that comes in this CD driver with the package. Please follow the instructions set forth in this chapter carefully. Please note that there must be relevant software installed in your system before you could proceed to install the VGA drivers.

The following items are covered in this chapter:

Installing the Drivers for Windows 98SE	58
Windows Me and Windows 2000	58
Windows Me and Windows Millennium Edition	58
Windows Me and Windows NT 4.0	58

Installing the 815E VGA Drivers for Windows 98SE Windows 2000 Windows Millennium Edition Windows NT 4.0

The following section describes the 815E VGA driver installation procedures for Windows 98SE, Windows 2000, Windows Millennium Edition and Windows NT 4.0.

Step 1: Insert driver CD into CD-ROM.

Step 2: Click **Server**.

Step 3: Click **RI7SM**.

Step 4: Click **Intel 815, 815E VGA Driver**.

Step 5: Click **Next**.

Step 6: Click **Yes**.

Step 7: Click **Finish**. You must restart your computer now.

Chapter 6

Audio Driver Installation Guide

This chapter provides information on how to install the AC' 97 CODEC Audio Driver that comes in this driver CD with the package. Please follow the instructions set forth in this chapter carefully. Please note that there must be relevant software installed in your system before you could proceed to install the Audio drivers.

The following items are covered in this chapter:

Installing the Drivers for Windows 98SE.....	60
Installing the Drivers for Windows 2000.....	60
Installing the Drivers for Windows Me	60
Installing the Drivers for Windows NT 4.0	60

Installing the Audio Drivers for Windows 98SE Windows 2000 Windows Millennium Edition Windows NT 4.0

The following section describes the Audio driver installation procedures for Windows 98SE, Windows 2000, Windows Millennium Edition and Windows NT4.0.

Step 1: Insert driver CD into CD-ROM **D Server**.

Step 2: Click **RI7SM**.

Step 3: Click **OnChip AC97 Audio Driver**.

Step 4: Click **Next**.

Step 5: Click **OK**. You must restart your computer now.

Chapter 7

LAN Driver Installation Guide

This chapter describes LAN features and driver installation of the onboard Intel ICH2.

The following items are covered in this chapter:

Introduction	62
Features	62
Installing LAN Driver for Win98SE/ Windows Millennium Edition	63
Installing LAN Driver for Windows 2000	73
Installing LAN Driver for Windows NT 4.0.....	80

Features

- Support of Wired for Management (WfM) Rev 2.0 Compliant
- Interface to discrete LAN connect component
- 10/100 Mbit/sec Ethernet support
- 1Mbit/sec HomePNA support
- Support wake-up on interesting packets and link status change
- Support for remote power-up using Wake on LAN (WOL) technology
- Deep power-down mode support
- Backward compatible software with 82557, 82558 and 82559
- Support for Intel's Adaptive Technology

Installing LAN Driver for Windows 98SE/ Windows Millennium Edition

This section describes the procedures to install Windows 98SE driver for Intel ICH2 LAN adapter.

Noted: The installation approach of Windows Millennium Edition is similar to Windows 98SE system.

Step 1: Copy the file “LAN \8255X\wol558.VXD” to
C:\Windows\system from CD-ROM driver.

Step 2: Copy two files “e100ba.cat” and “8255Xndi.dll” to
C:\Windows\CATROOT” from CD-ROM driver.

Step 3: Click **Start** **➤** **Settings** **➤** **Control Panel**.

Step 4: Double click **System**.

Step 5:

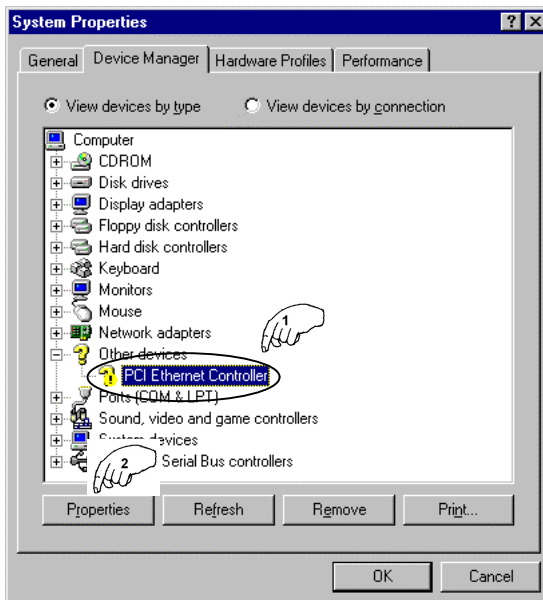

Step 6: Click **Driver** **➤** **Update Driver**.

Step 7: Click **Next**.

Step 8:

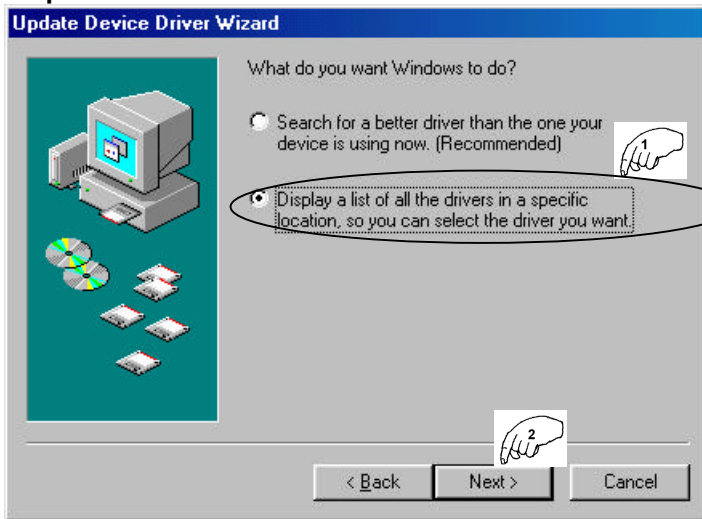

Step 9:

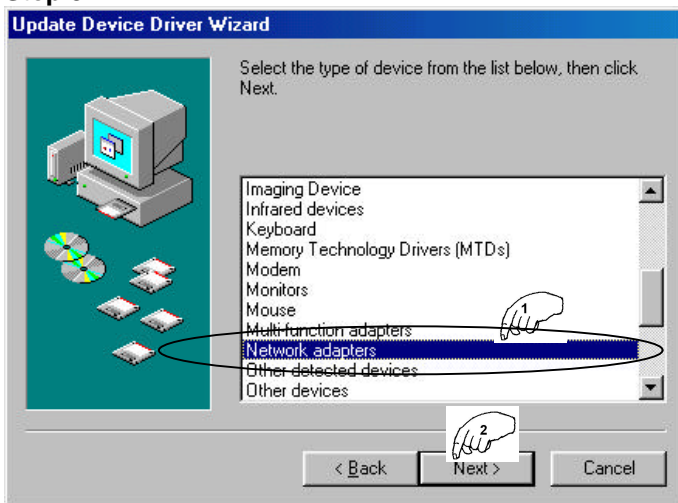

Step 10:

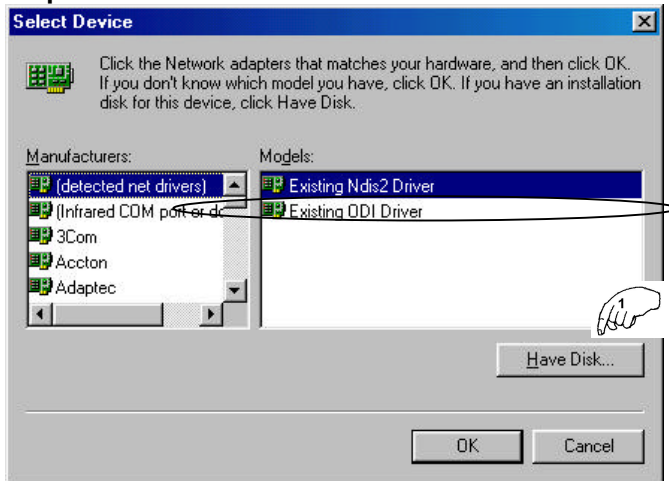

Step 11: Click **Browser** ⇒ D:\LAN\8255X.

Step 12:

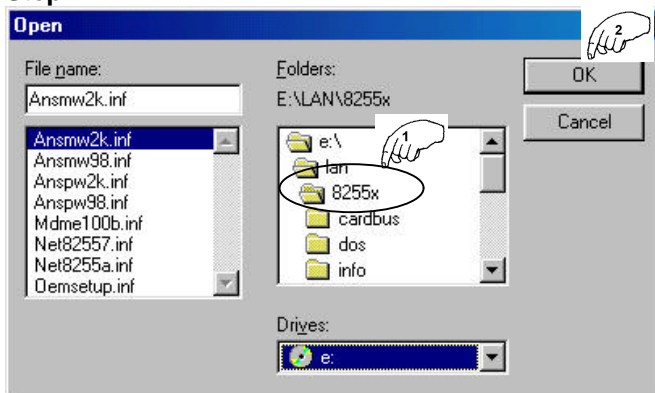

Step 13:



Step 14:

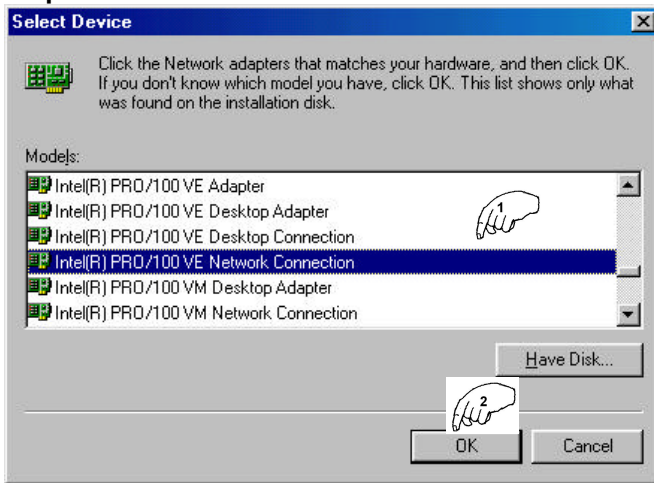

Step 15:



Step 16: Neglecting this picture appears, clicks **OK** to next procedures.

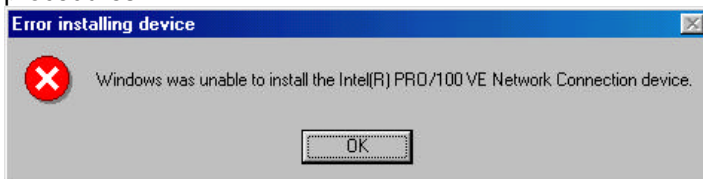

Step 17:

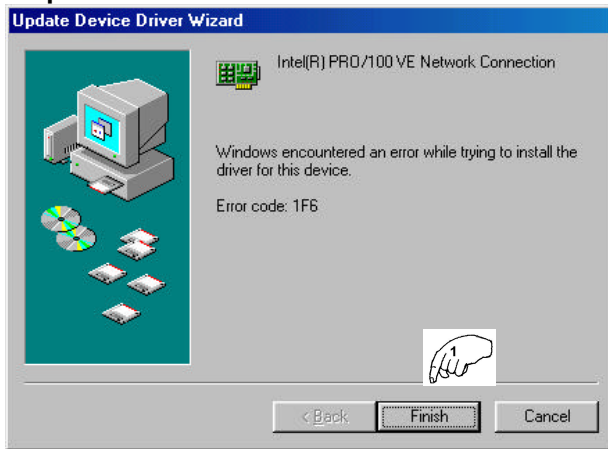

Step 18: Click **Yes**. You must restart your computer now.

Step 19: Click **Start** **»** **Settings** **»** **Control Panel**.

Step 20:

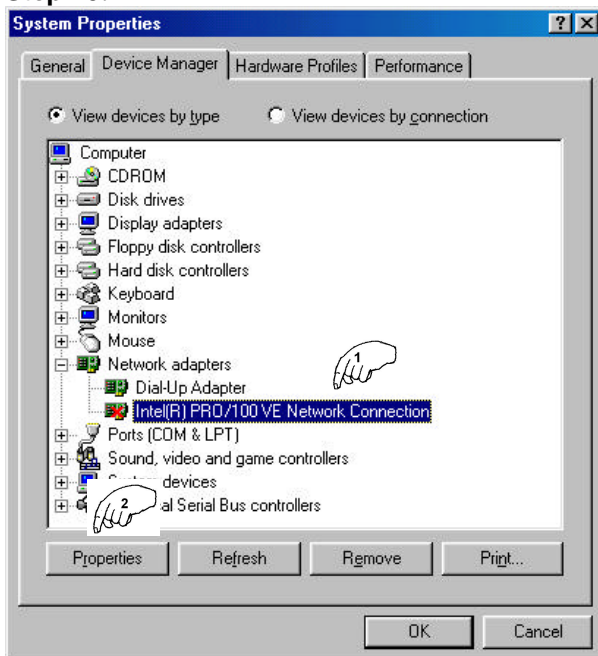

Step 21:

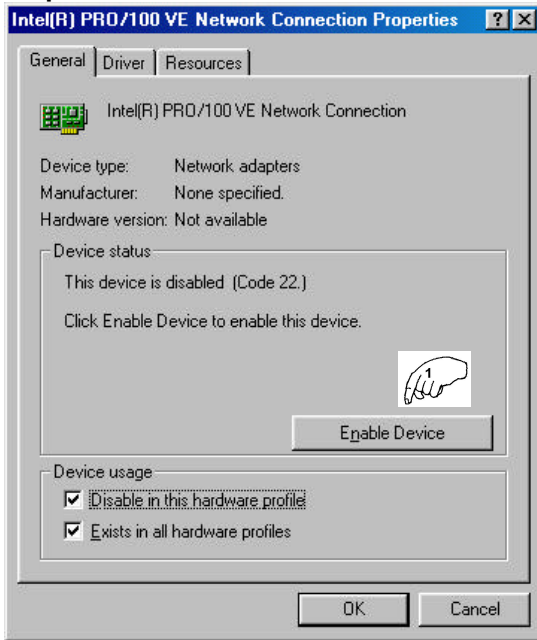

Step 22:

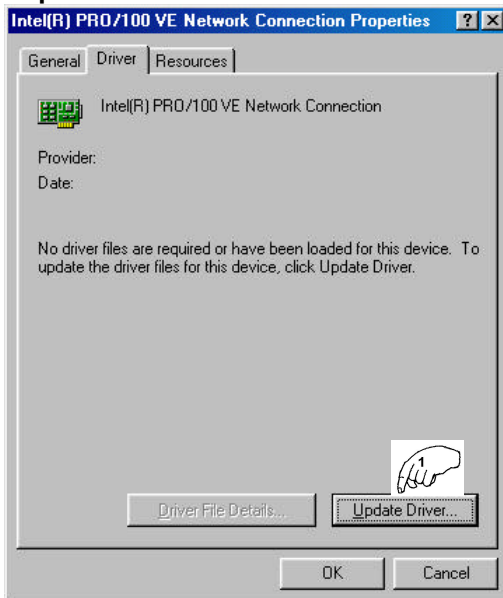

Step 23:



Step 24:

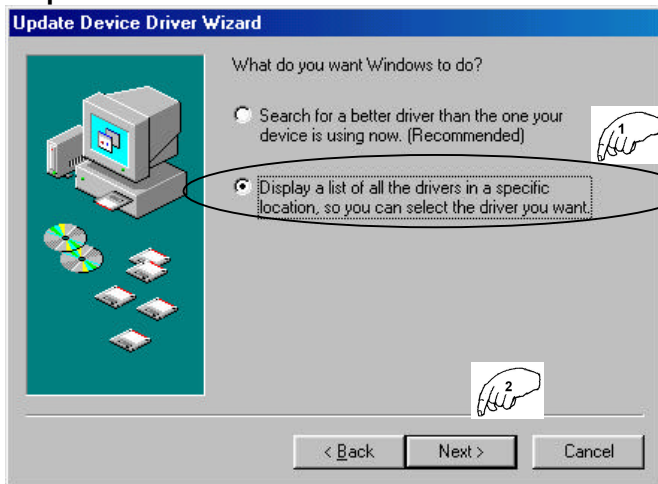

Step 25:

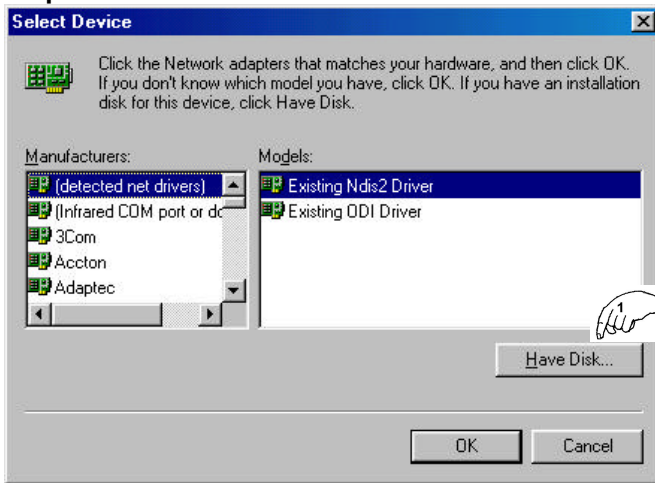

Step 26:

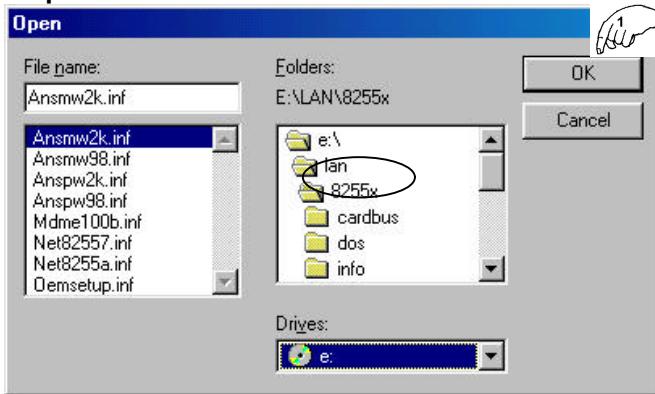

Step 27:

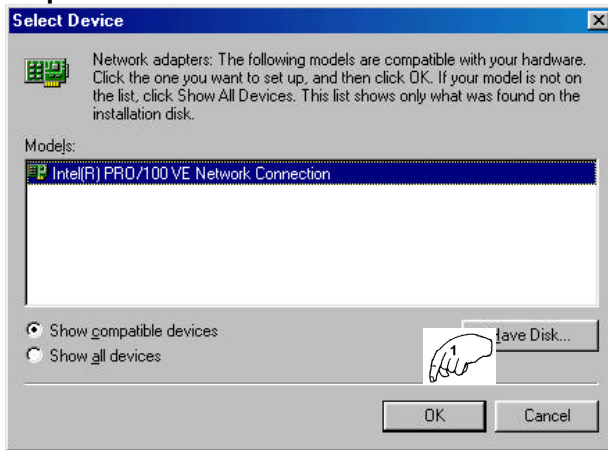

Step 28:



Step 29: Type correct CD-ROM path. ex: e:\lan\8255X **OK**

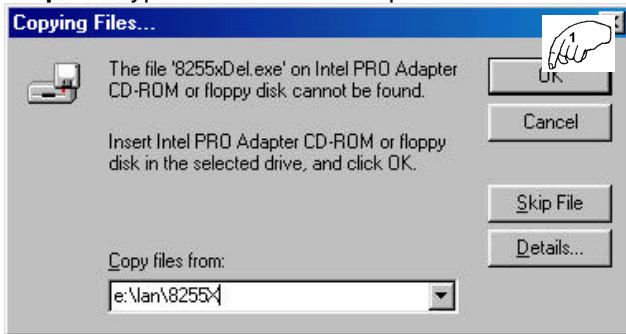

Step 30:

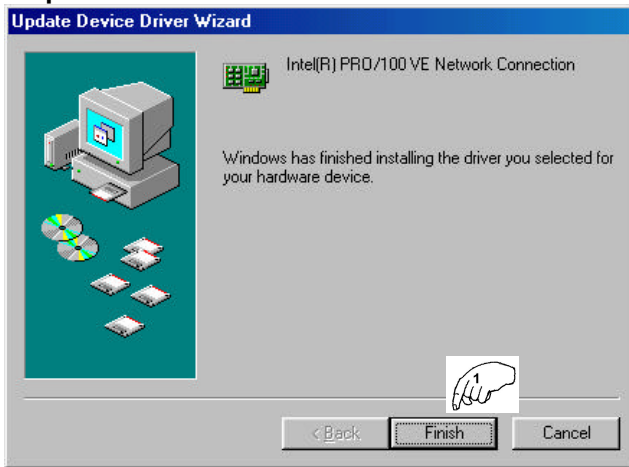

Step 31: Click **Yes**. You must restart your computer now.

Installing LAN Driver for Windows 2000

This section describes the procedure to install Windows 2000 driver for Intel ICH2 LAN adapter.

Step 1: Click **Start** **▶** **Settings** **▶** **Control Panel**.

Step 2: Double click **System**.

Step 3: Click “**Device Manager**”

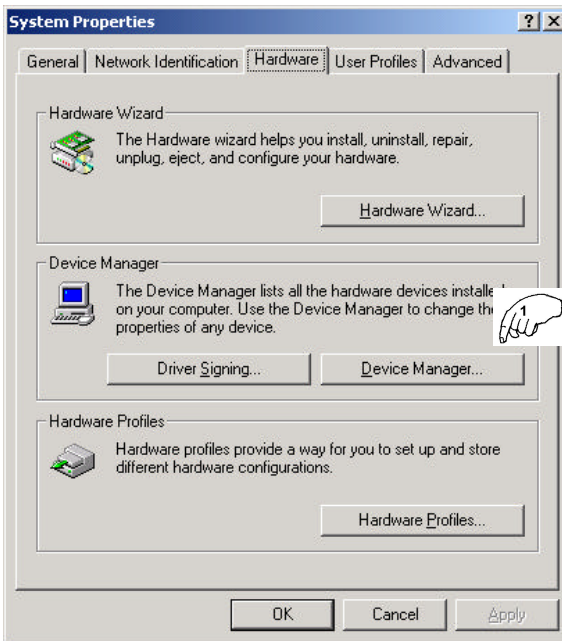

Step 4:

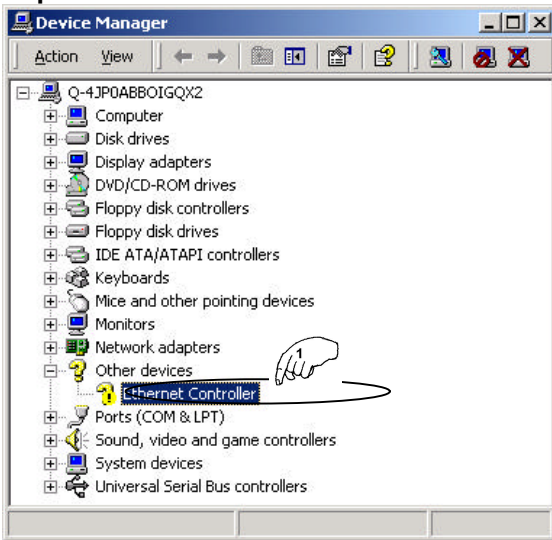

Step 5: Double click “Ethernet Controller”.

Step 6: Click “Reinstall Driver”.

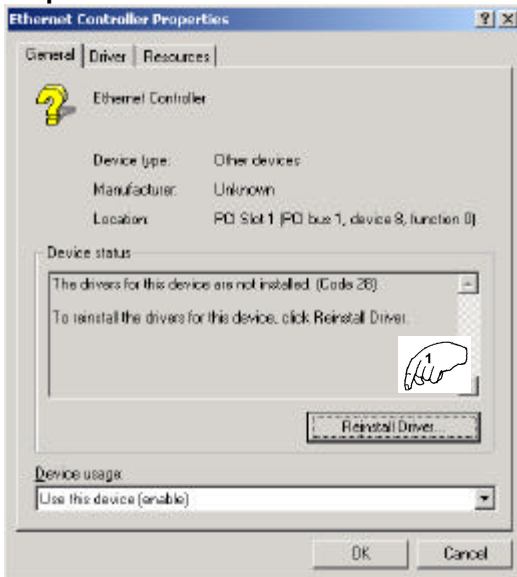

Step 7: Click *NEXT*.



Step 8: Insert driver CD into CD-ROM.

Step 9: Select “*Display a list of the known drivers for device so that I can choose a specific driver*” **➤ NEXT.**

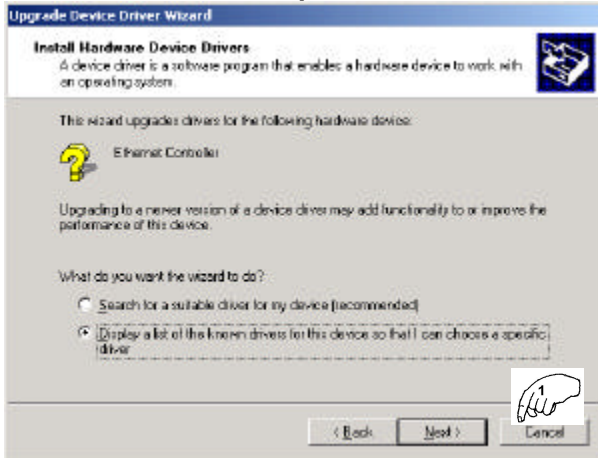

Step 10: Choose “Network adapters” ➔ NEXT’.

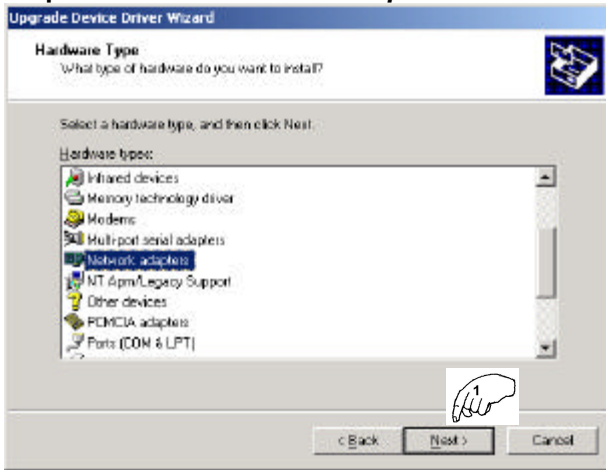

Step 11:

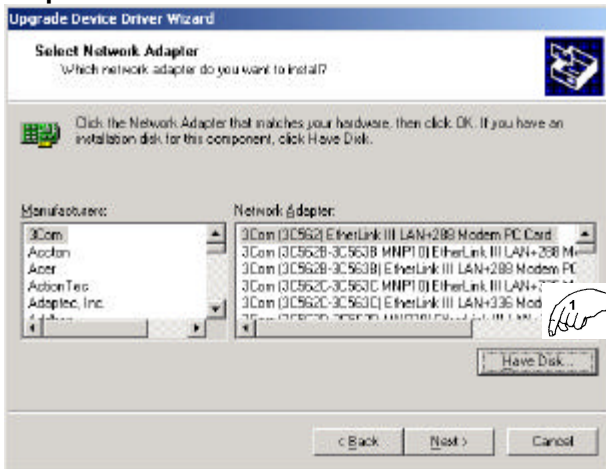

Step 12: Type correct path with CD-ROM driver. ex:
e:\lan\8255X **▶ OK.**

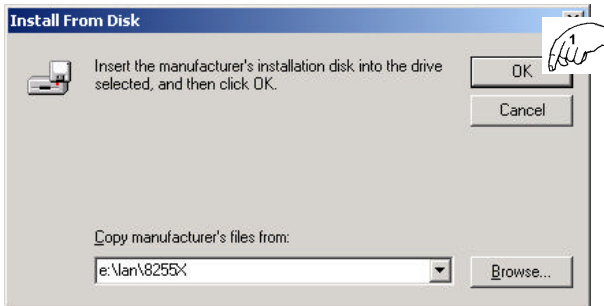

Step 13: Choose **“Intel PRO/100 VM Network Connection”** ⇒
NEXT.

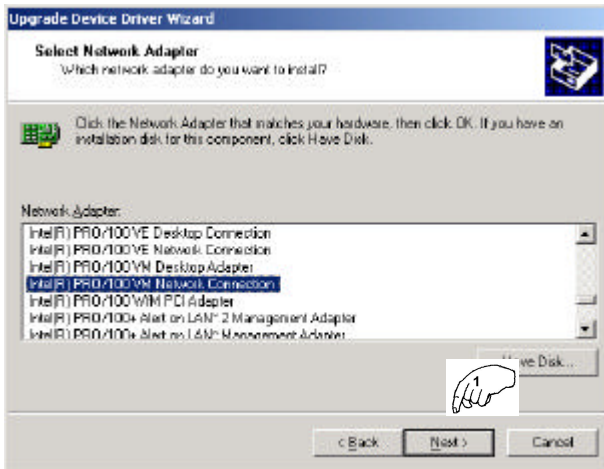

Step 14: Click *NEXT*.

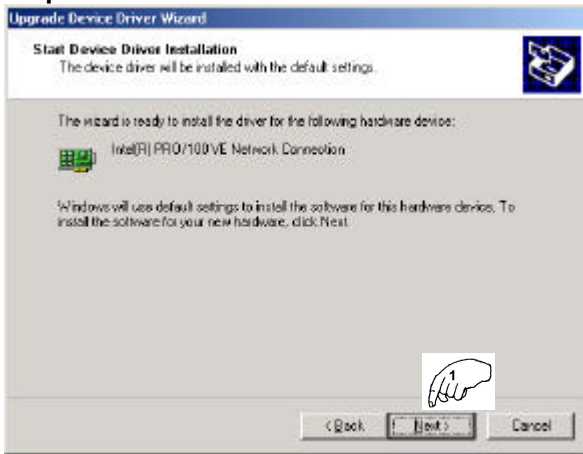

Step 15: Click *Finish*.

Step 16: Click *Yes*. You must restart your computer now.

Installing LAN Driver for Windows NT 4.0

You should install the Windows NT 4.0 Service Pack 3 or above first before installing the drivers. If you do not have the Windows NT 4.0 Service Pack 3 or above, please contact your software vendor or download it from Microsoft's web site. The procedures below show you how to install the LAN drivers for Windows NT 4.0.

Noted: You can select item “Intel 8255X MakeDisk Utility” from this driver CD to **Make Diskette** before the procedures are installing.

Step 1: Insert Driver CD into CD-ROM Drive **➤ Server ➤ RI7SM ➤ Intel 8255x ➤ MakeDisk Utility.**



Step 2: Inset a blank disk into floppy drive **➤ Windows NT 4.0 ➤ Create Disk.**

Step 3: Click **Start ➤ Settings ➤ Control Panel.**

Step 4: Double click **Network**

Step 5: Click **Adaptor ➤ ADD.**

Step 6: Insert diskette into floppy **➤ Have Disk.**

Step 7: Click **OK.**

Step 8: Click **OK.**

Step 7: Click **Close.**

Step 9: The LAN adapter must be filled in IP Address, Subnet Mask and Default Gateway **➤ OK.**

Step 10: Click **Yes.** You must restart your computer now.

This page was intentionally left blank.

Chapter 8

Ultra ATA IDE Driver Installation Guide

This chapter provides information on how to install the Ultra ATA IDE Driver that comes in this CD driver with the package. Please follow the instructions set forth in this chapter carefully.

The following items are covered in this chapter:

Installing the Drivers for Windows 98SE, Windows 2000,
Windows Millennium Edition and Windows NT 4.0..... 82

Installing Ultra ATA IDE the Drivers for Windows 98SE Windows 2000 Windows Millennium Edition Windows NT 4.0

The following section describes the Ultra ATA IDE driver installation procedure for Windows 98SE, Windows 2000, Windows Millennium Edition and Windows NT 4.0.

Step 1: Insert driver CD into CD-ROM.

Step 2: Click **Server**.

Step 3: Click **RI7SM**.

Step 4: Click **Ultra ATA IDE Driver**.

Step 5: Click **Next**.

Step 6: Click **Yes**.

Step 7: Click **Next**.

Step 8: Click **Next**.

Step 9: Click **Finish**. You must restart your computer now.

Appendix

A. I/O Port Address Map

B. Interrupt Request Lines (IRQ)

A. I/O Port Address Map

Each peripheral device in the system is assigned a set of I/O port addresses, which also becomes the identity of the device. There is a total of 1K port address space available. The following table lists the I/O port addresses used on the Industrial CPU Card.

Address	Device Description
000h - 01Fh	DMA Controller #1
020h - 03Fh	Interrupt Controller #1
040h - 05Fh	Timer
060h - 06Fh	Keyboard Controller
070h - 07Fh	Real Time Clock, NMI
080h - 09Fh	DMA Page Register
0A0h - 0BFh	Interrupt Controller #2
0C0h - 0DFh	DMA Controller #2
0F0h	Clear Math Coprocessor Busy Signal
0F1h	Reset Math Coprocessor
1F0h - 1F7h	IDE Interface
278 - 27F	Parallel Port #2(LPT2)
2F8h - 2FFh	Serial Port #2(COM2)
2B0 - 2DF	Graphics adapter Controller
378h - 3FFh	Parallel Port #1(LPT1)
360 - 36F	Network Ports
3B0 - 3BF	Monochrome & Printer adapter
3C0 - 3CF	EGA adapter
3D0 - 3DF	CGA adapter
3F0h - 3F7h	Floppy Disk Controller
3F8h - 3FFh	Serial Port #1(COM1)

B. Interrupt Request Lines (IRQ)

There are a total of 15 IRQ lines available on the Industrial CPU Card. Peripheral devices use interrupt request lines to notify CPU for the service required. The following table shows the IRQ used by the devices on the Industrial CPU Card.

Level	Function
IRQ0	System Timer Output
IRQ1	Keyboard
IRQ2	Interrupt Cascade
IRQ3	Serial Port #2
IRQ4	Serial Port #1
IRQ5	Parallel Port #2
IRQ6	Floppy Disk Controller
IRQ7	Parallel Port #1
IRQ8	Real Time Clock
IRQ9	Software Redirected to Int 0Ah
IRQ10	Reserved
IRQ11	Reserved
IRQ12	Reserved
IRQ13	80287
IRQ14	Primary IDE
IRQ15	Secondary IDE