

PENTIUM PCI/ISA

**AT Form PCI & ISA Bus Pentium Mainboard
On Board PCI Master IDE, Multi-I/O, VGA.**

R534G

Users Manual

Introduction

Welcome to the M-Technology next generation high performance Pentium system mainboard ---Mustang **R-534G**. The R-534G using the high performance SIS 5571 Chipset that will deliver superior performance on your personal computer.

About This User's Guide

This User's Guide is for assisting system manufacturers and end users in setting up and installing the mainboard. Information in this guide has been carefully checked for reliability; however, there may still be inaccuracies and information in this document is subject to change without notice.

DISCLAIMER

The information in this manual has been carefully checked and is believed to be accurate. We assume no responsibility for any inaccuracies that may still be contained in this manual. We reserve the right to make changes to this material at any time without notice.

※ All Brand names are trademarks of their owners.

* Our home page on Internet "<http://www.mtiusa.com>"

Table of Contents

Chapter 1 INTRODUCTION

1.1 Preface	1-1
1.2 Key Features	1-1
1.3 Mainboard Layout	1-3

Chapter 2 HARDWARE INSTALLATION

2.1 Unpacking	2-1
2.2 Jumper Setting Summary	2-2
2.3 CPU Installation	2-4
2.3.1 CPU Frequency Configuration	2-4
2.3.2 CPU Voltage Configuration	2-5
2.3.3 CPU Speed & Jumper Setting	2-6
2.3.4 CPU Type Select Quick Reference	2-8
2.3.5 Installing a CPU in the ZIF Socket	2-16
2.4 Upgrading System Memory	2-17
2.4.1 Installing a SIMM Module.....	2-17
2.4.2 Installing a DIMM Module.....	2-18
2.4.3 Memory Modules Voltage Selector.....	2-18
2.4.4 Memory Bank & RAM Type Selector.....	2-19
2.4.5 Memory Module Installing Table.....	2-20
2.5 CMOS Clear Jumper.	2-21
2.6 Flash EPROM Selector	2-21
2.7 Cache RAM Access Mode Selector	2-22
2.8 Connectors	2-23
2.8.1 I/O Ports	2-24
2.8.2 External Connections	2-25

Chapter 3 BIOS Setup

3.1 Standard CMOS Setup	3-2
3.2 BIOS Features Setup	3-3
3.3 Chipset Features Setup	3-6
3.4 Power Management Setup	3-9
3.5 PNP/PCI Configuration Setup.....	3-11
3.6 Load Setup Defaults	3-12
3.7 Integrated Peripherals	3-13
3.8 Supervisor Password.....	3-15
3.9 User Password	3-16
3.10 IDE HDD Auto Detection.....	3-17

1. INTRODUCTION

1.1. Preface

Welcome to use the R-534G Pentium system mainboard. This manual explains how to use this mainboard and install upgrades. It has overview of the design and features of the board and provides useful information on the configuration of the board, or a system in which.

1.2. Key Features

The R-534G Pentium system mainboard is a high-performance system board that support Intel Pentium family CPUs, Cyrix, AMD and other compatible CPUs.

There has many performance and system features integrated onto the mainboard, including the following :

- ❑ CPU : Supports Socket 7 for
 - Intel Pentium 90 to 233 MHz, P55C (MMX).
 - Cyrix / IBM 6x86, 6x86L, 6x86MX (M2),
 - AMD K5, K6 .and other compatible CPUs.
- ❑ Chipset : SIS 5571
- ❑ Supports true 64 bits CACHE and DRAM access mode.
- ❑ Supports 512K Pipelined Burst SRAM in second Level Cache.
- ❑ CPU L1/L2 Write-Back cache operation.
- ❑ Supports 4x72-pin SIMM Sockets and 2 x 168-pin DIMM SDRAM or DRAM Sockets.
 - The Memory size from 2MB to 384MB.
 - Supports FP(Fast Page), EDO(Extended Data Out) Mode DRAM and SDRAM.
- ❑ Five 16-bit ISA Slots and Three 32-bit PCI Master Mode Slots.

【1】

- ❑ 2 x IDE Connectors for up to 4 IDE Drives.
 - PIO Mode 4 transfers.
 - PCI Bus Master Mode IDE interface.

- ❑ On-board I / O support :
 - 2 Serial Ports (16550 Fast UART compatible).
 - 1 Parallel Port (with EPP and ECP capabilities).
 - 1 Floppy Disk Connector (Supports 2 FD Drives).
 - 1 PS/2 Mouse Connector.
 - 1 IrDA Connector.

- ❑ Universal Serial Bus Controller.
 - Host / HUB Controller.
 - Two USB Ports.
 - ※ Now under compatibility testing with different peripheral.

- ❑ Flash ROM BIOS with Green, Plug and Play Features

- ❑ Baby AT Form Factor : 22cm x 28cm or 8.7" x 11" (4 Layers).

1.3 R-534G Mainboard Layout

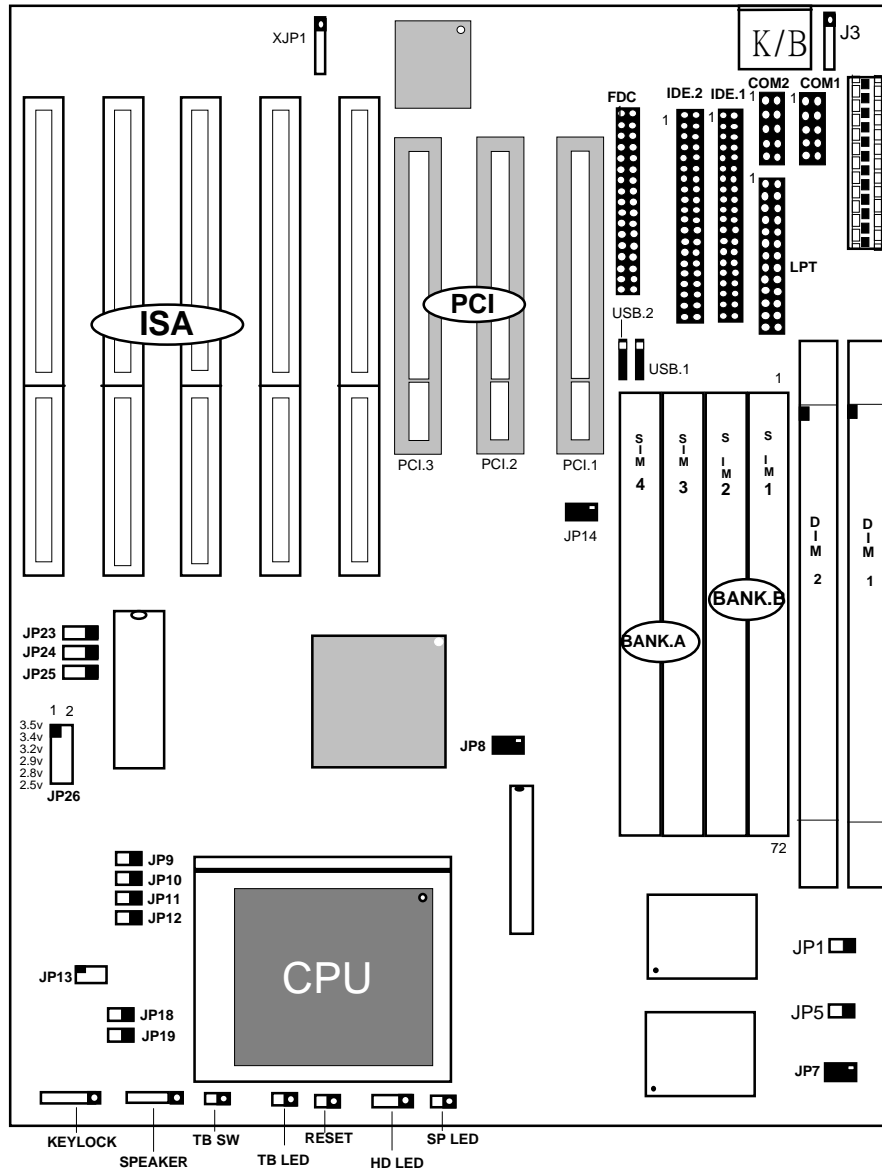

2. HARDWARE INSTALLATION

This chapter explains how to configure the system main board hardware. After you install the main board, you can set jumpers and make case connections. Refer to this chapter whenever you upgrade or reconfigure your system.

2.1 Unpacking

The mainboard package should contain the following:

- ◆ The **R-534G** mainboard.
- ◆ USER'S MANUAL for R-534G mainboard.
- ◆ Cable set for IDE, Floppy , I/O device.

The mainboard contains sensitive electric components which can be easily damaged by static electricity, so the mainboard should be left in its original packing until it is installed.

Unpacking and installation should be done on a grounded anti-static mat.

The operator should be wearing an anti static wristband, grounded at the same point as the anti-static mat.

Inspect the mainboard carton for obvious damage. Shipping and handling may cause damage to your board. Be sure there are no shipping and handling damages on the board before proceeding.

After opening the mainboard carton, extract the system board and place it only on a grounded anti-atatic surface component side up. Again inspect the board for damage.

Press down on all of the socket IC's to make sure that they are properly seated. Do this only on with the board placed on a firm flat surface.

【2】



Do not apply power to the board if it has been damaged.

You are now ready to install your mainboard. The mounting hole pattern on the mainboard matches the system board.

It is assumed that the chassis is designed for a standard AT mainboard mounting. Place the chassis on the anti-static mat and remove the cover.

Take the plastic clips, Nylon stand-off and screws for mounting the system board, and keep them separate.

2.2 Jumper Setting Summary

Regarding hardware settings on the board. They specify configuration options for various features. The settings are made using something called a "Jumper". A jumper is a set of two or more metal pins in a plastic base attached to the mainboard. A plastic jumper "cap" with a metal plate inside fits over two pins to create an electrical contact between them. The contact establishes a hardware setting.

Some jumpers have two pins, other have three or more. The jumpers are sometimes combined into sets called jumper "blocks", where all the jumpers in the block must be set together to establish a hardware setting. The next figures show how this works.

Jumpers and caps

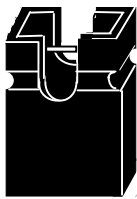

Jumper cap

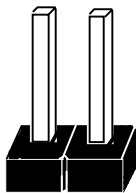

2-Pin Jumper

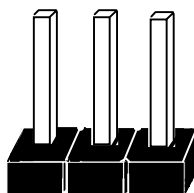

3-Pin Jumper

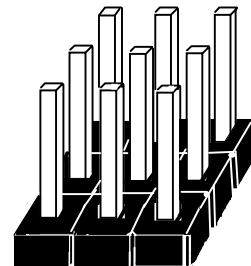

Jumper block

Most jumper settings are printed on the board in a stylized bird's-eye view, with which pins to connect for each setting marked by a bar connecting two pins. For example, if a jumper has three pins, connecting or "closing", the first and second pins creates one setting and closing the second and third pins creates another. The same type of diagrams are used in this manual. The jumpers are always shown from the same point of view as shown in the whole board diagram in this chapter.

Jumpers diagrams

Jumpers are shown like this

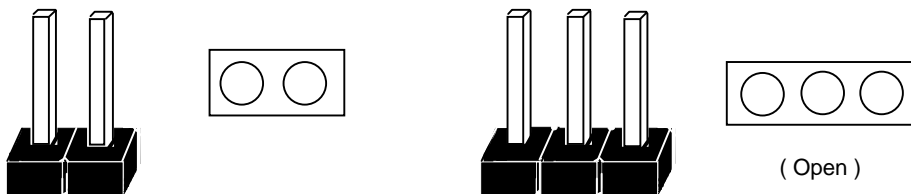

Jumper caps like this

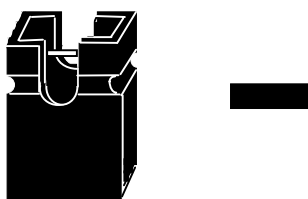

Jumper settings like this

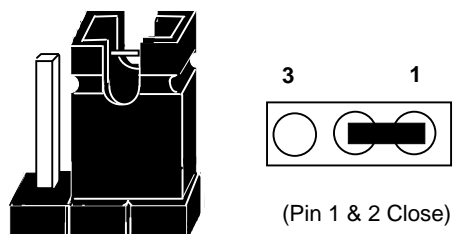

※ The Red colors Jumper for system Voltage setting, and the Yellow colors Jumper for system Clock setting, please careful to change it.

2.3 CPU Installation

The mainboard supports Pentium class processors up to 233 MHz, If you install the CPU on this board, you must set the **System Clock** (JP1, JP9, JP10, JP11,JP12), **Frequency Ratio** (JP18, JP19) and **CPU Power Voltage** (JP13, JP26) to meet variable CPU specifications. (JP10, for Feature Function)

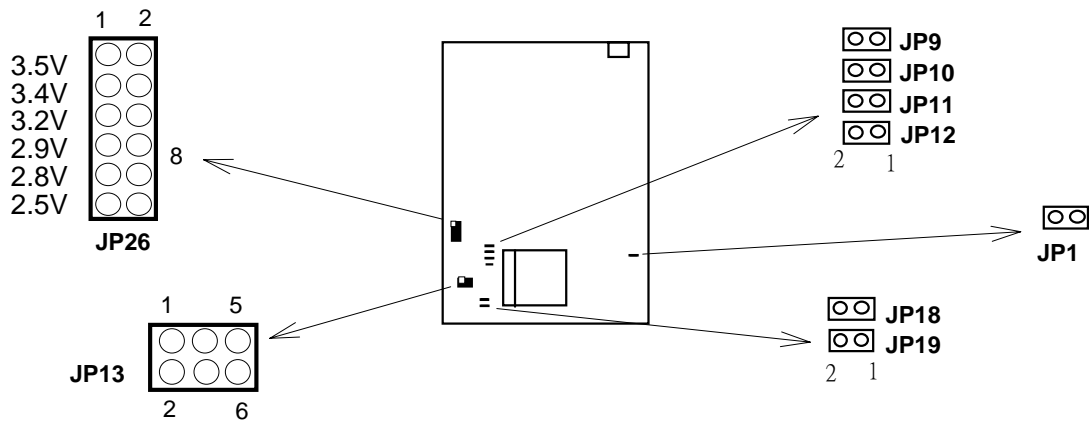

2.3.1. CPU Speed Configuration:





Freq ratio	JP18, JP19
1.5	
2	
2.5	
3	
3.5	

System freq (MHz)	JP1	JP9,JP10,JP11,JP12
55		
60		
66		
75		
83**		







- * CPU Speed = (Frequency ratio) x (System Frequency).
- ** PCI has a maximum bandwidth of 33MB --- one half of the 66 MHz System Frequency. The 83MHz System Frequency are not supported by the current PCI Rev. 2.1 Specification.

2.3.2. CPU Voltage Configuration:

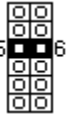
(a) For Single Power CPU. (Intel P54C, Cyrix 6x86, IBM 6x86, AMD 5K86)

CPU Power Voltage		JP13	JP26
I/O	Core		
3.4 V			
3.5 V			

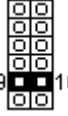
(b) For Dual Power CPU. (Intel P55C (MMX), Cyrix 6x86L/6x86MX(M2), IBM 6x86L/6x86MX(M2), AMD K6)

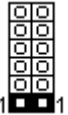
CPU Power Voltage		JP13	JP26
I/O	Core		
3.4v	3.2v		
3.4v	2.9v		
3.4v	2.8v		
3.4v	2.5v		

【2】

2.3.3. The CPU Speed & Jumper setting.

(a) Intel Pentium CPU.

CPU Type	System Clock						Frequency Ratio		
	MHz	JP1	JP9	JP10	JP11	JP12	/	JP18	JP19
90MHz	60	Close	Open	Close	Open	Close	3/2	Open	Open
100MHz	66	Close	Open	Open	Close	Close			
120MHz	60	Close	Open	Close	Open	Close	2/1	Close	Open
133MHz	66	Close	Open	Open	Close	Close			
150MHz	60	Close	Open	Close	Open	Close	5/2	Close	Close
166MHz	66	Close	Open	Open	Close	Close			
180MHz	60	Close	Open	Close	Open	Close	3/1	Open	Close
200MHz	66	Close	Open	Open	Close	Close			
233MHz	66	Close	Open	Open	Close	Close	7/2	Open	Open

(b) Cyrix 6x86 & 6x86L and IBM 6x86 & 6x86L CPU.

CPU Type	System Clock						Frequency Ratio		
	MHz	JP1	JP9	JP10	JP11	JP12	/	JP18	JP19
PR133 +	55	Open	Close	Open	Open	Close	2/1	Close	Open
PR150 +	60	Close	Open	Close	Open	Close			
PR166 +	66	Close	Open	Open	Close	Close			
PR200 +	75	Close	Close	Close	Open	Open			

(c) Cyrix 6x86MX (M2) and IBM 6x86 MX(M2) CPU.

CPU Type	System Clock						Frequency Ratio		
	MHz	JP1	JP9	JP10	JP11	JP12	/	JP18	JP19
PR166	60	Close	Open	Close	Open	Close	5/2	Close	Close
PR200	66	Close	Open	Open	Close	Close			
PR233	66	Close	Open	Open	Close	Close	3/1	Open	Close
PR233	75	Close	Close	Close	Open	Open	5/2	Close	Close
PR266	66	Close	Open	Open	Close	Close	7/2	Open	Open
PR266	75	Close	Close	Close	Open	Open	3/1	Open	Close

※ We recommend the end user to choose the version 2.7 or later of Cyrix/
IBM 6x86 processor.

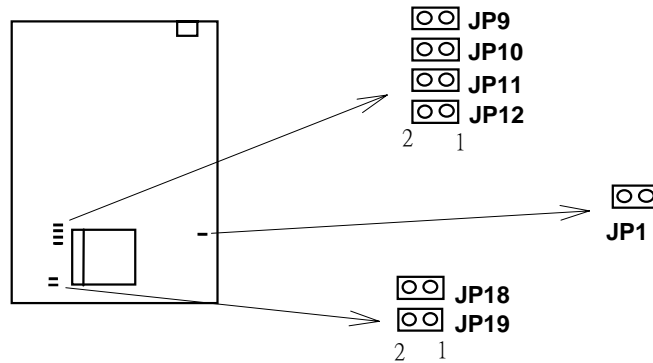

(d) AMD 5k86 CPU.

CPU Type	System Clock						Frequency Ratio		
	MHz	JP1	JP9	JP10	JP11	JP12	/	JP18	JP19
P90	60	Close	Open	Close	Open	Close	3/2	Open	Open
P100	66	Close	Open	Open	Close	Close			
P166	66	Close	Open	Open	Close	Close			

(e) AMD K6 CPU.

CPU Type	System Clock						Frequency Ratio		
	MHz	JP1	JP9	JP10	JP11	JP12	/	JP18	JP19
PR166	66	Close	Open	Open	Close	Close	5/2	Close	Close
PR200		Close					3/1	Open	Close
PR233		Close					7/2	Open	Open

- ※ 1. For the AMD K5-PR120/133, it is also allowed to use ratio "x1.5", which is equal to the Intel Pentium 90/100MHz settings.
- 2. For the AMD K5-150/160, it use the same settings as the Intel Pentium 150/166MHz processor.

【2】

2.3.4. CPU Type Select Quick Reference :

(a) Intel Pentium CPU.

(1) Intel P54C-90MHz.

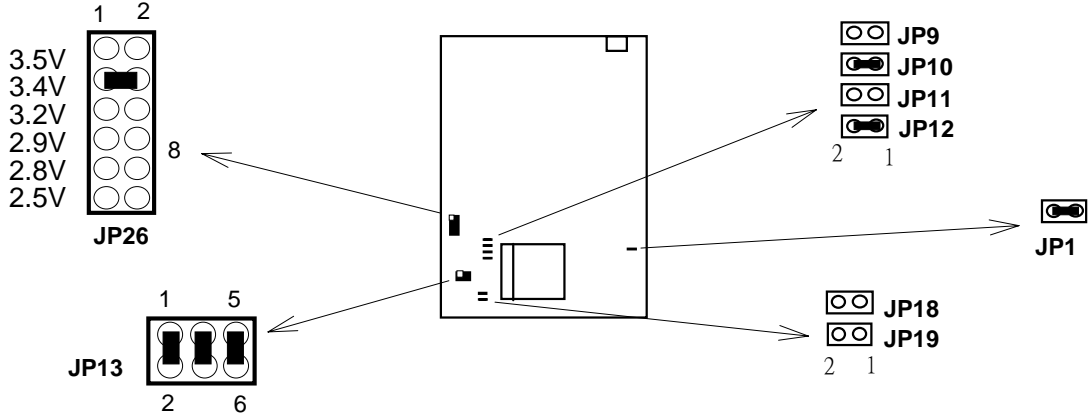

(2) Intel P54C-100MHz.

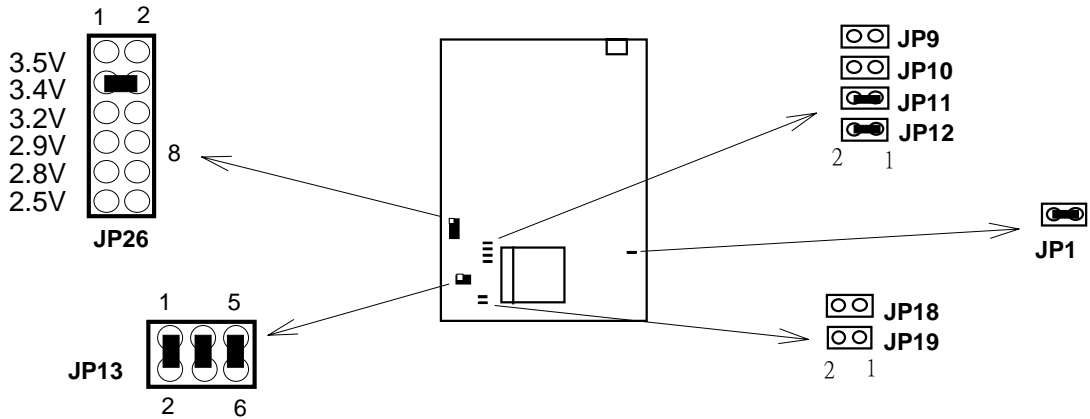

(3) Intel P54C-120MHz.

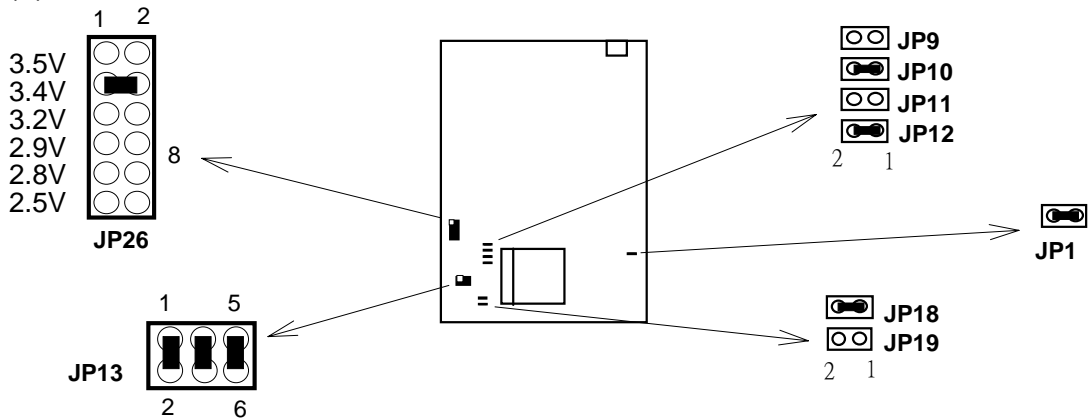

(4) Intel P54C-133MHz.

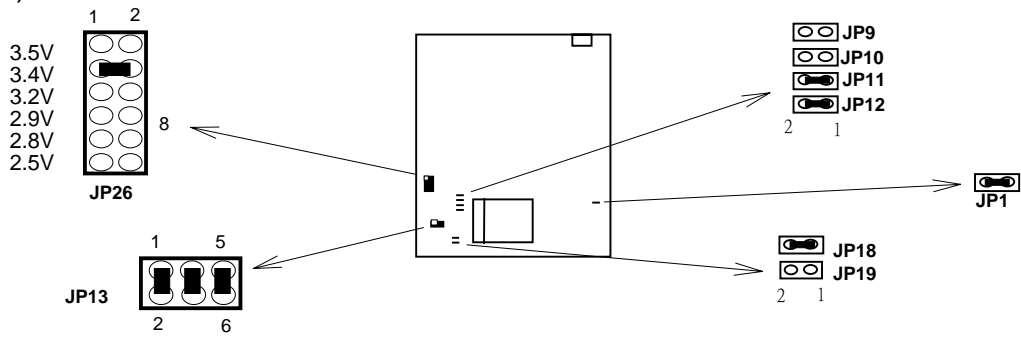

(5) Intel P54C-150MHz.

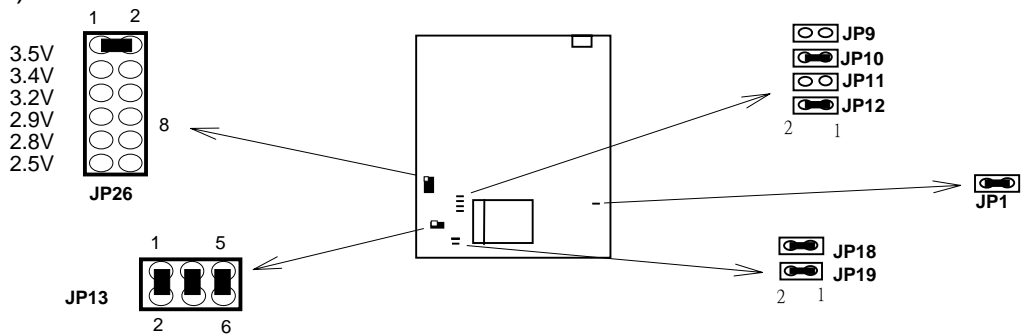

(6) Intel P54C-166MHz.

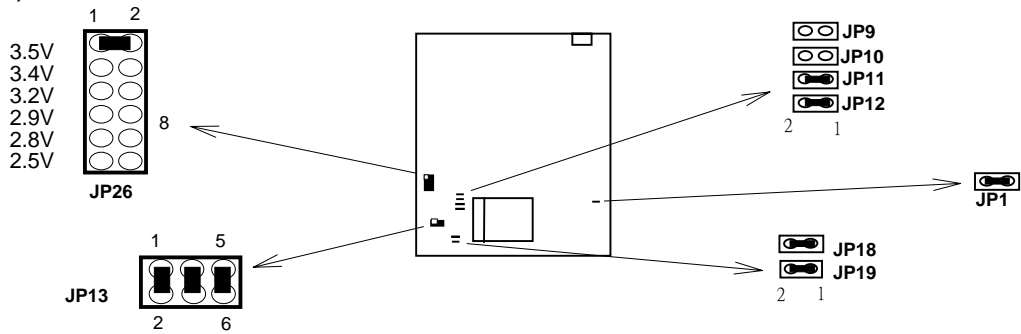

(7) Intel P54C-180MHz.

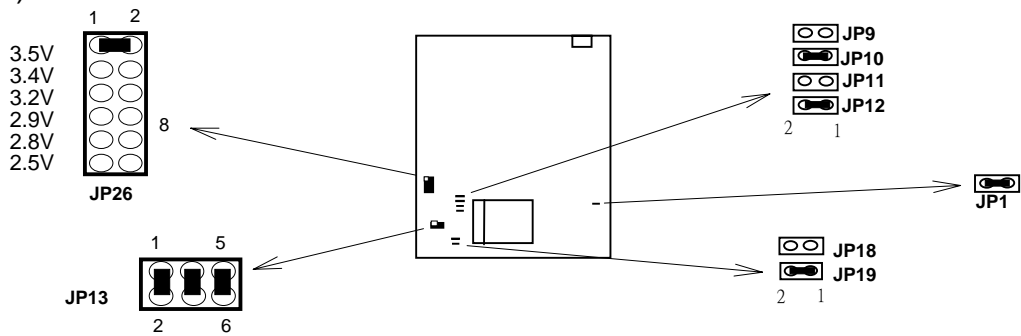

[2]

(8) Intel P54C-200MHz.

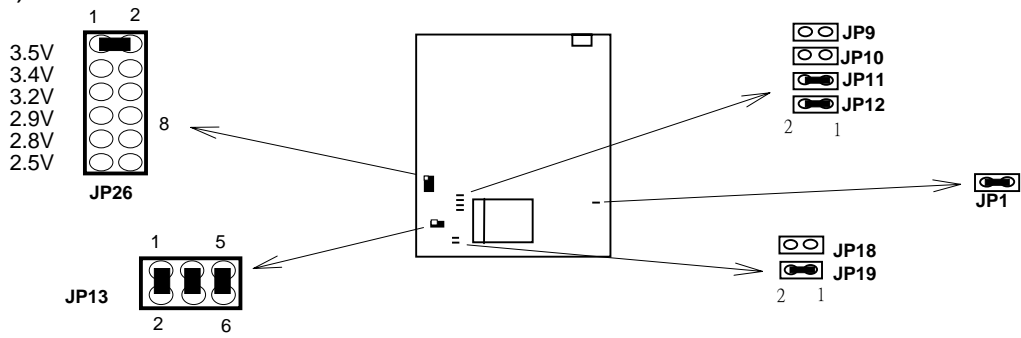

(9) Intel P55C (MMX) -166MHz.

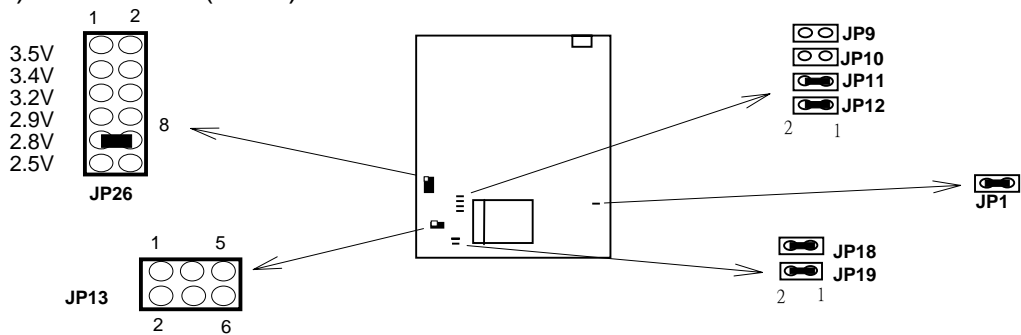

(10) Intel P55C (MMX) -200MHz.

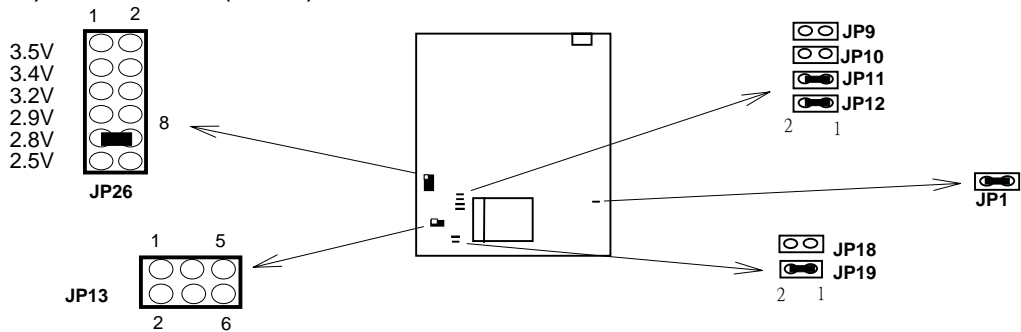

(11) Intel P55C (MMX) -233MHz.

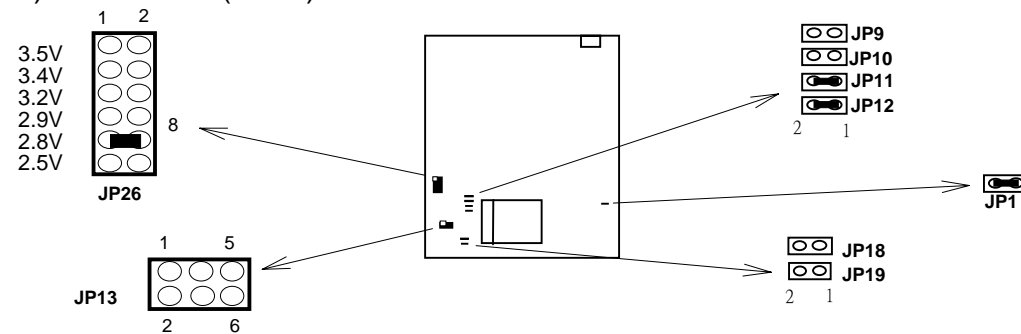

(b) Cyrix 6x86, IBM 6x86 CPU.

(1) 6x86 - PR133+

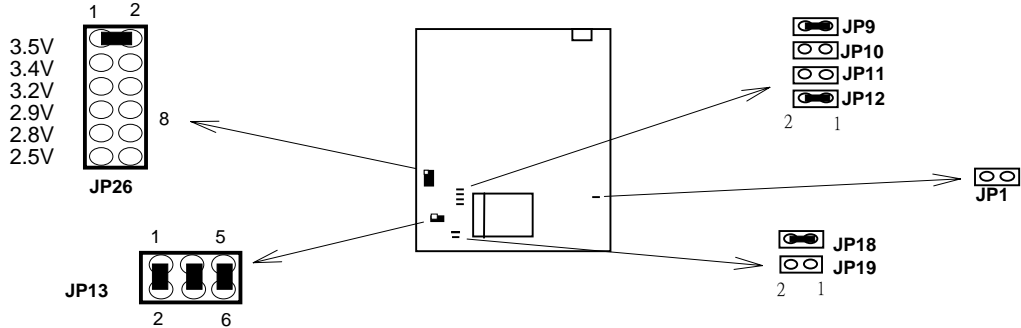

(2) 6x86 - PR150+

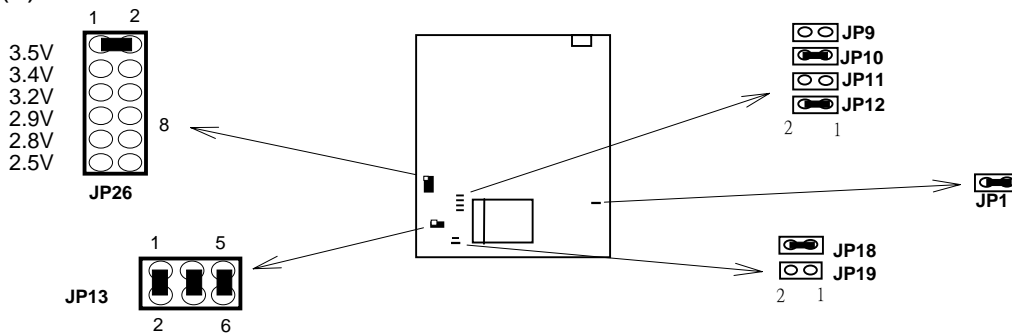

(3) 6x86 - PR166+

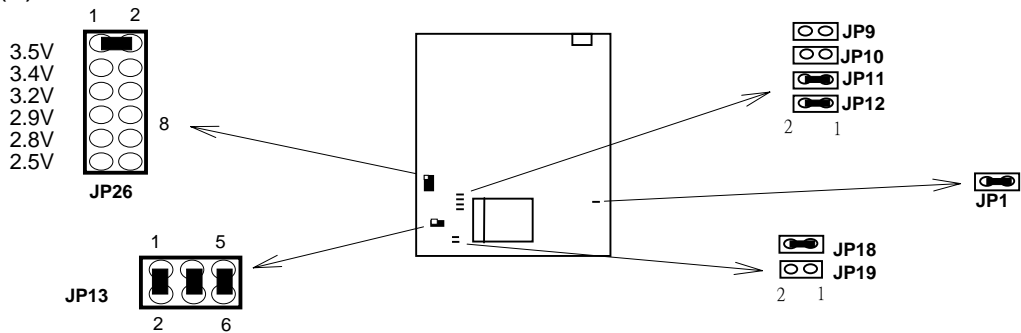

(4) 6x86 - PR200+

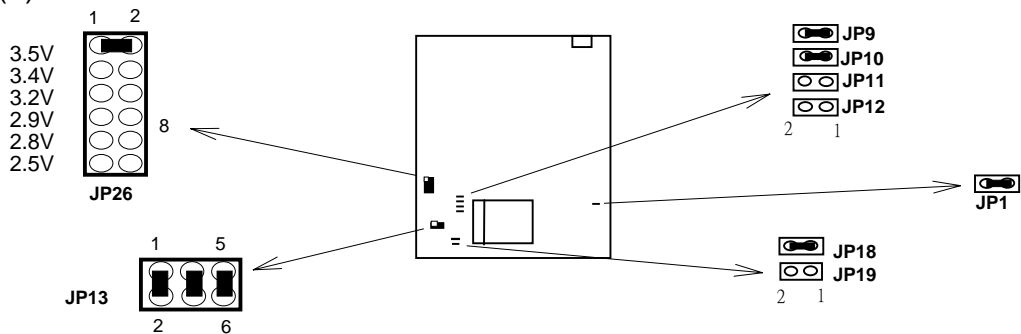

【2】

(c) Cyrix 6x86L & 6x86MX (M2), IBM 6x86L & 6x86MX (M2).

(1) 6x86L - PR166.

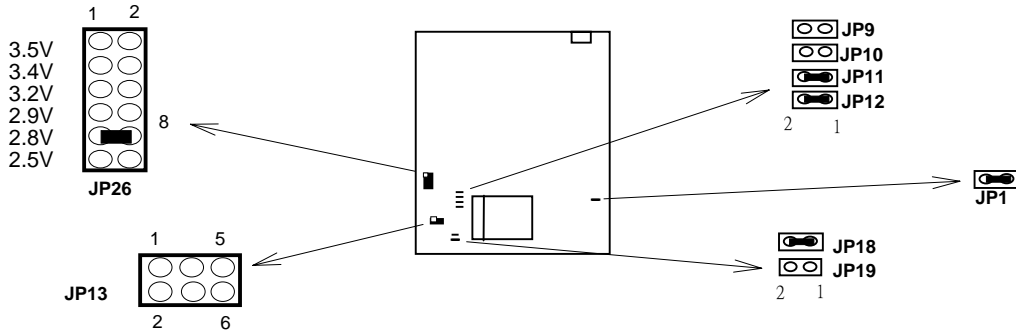

(2) 6x86L - PR200.

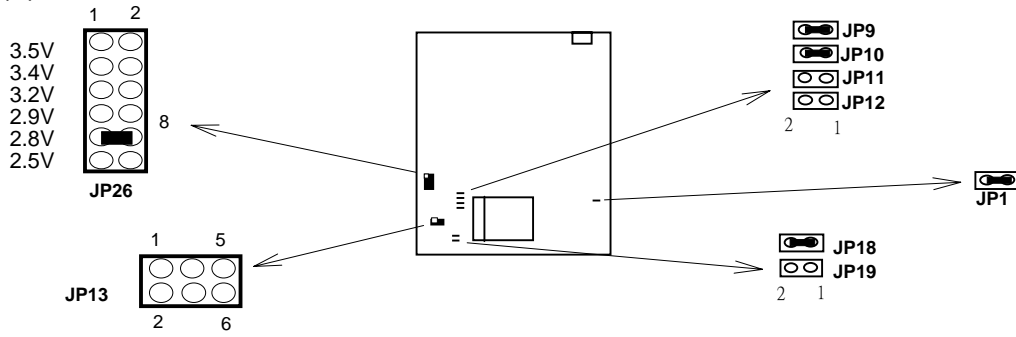

(3) 6x86MX - PR166.

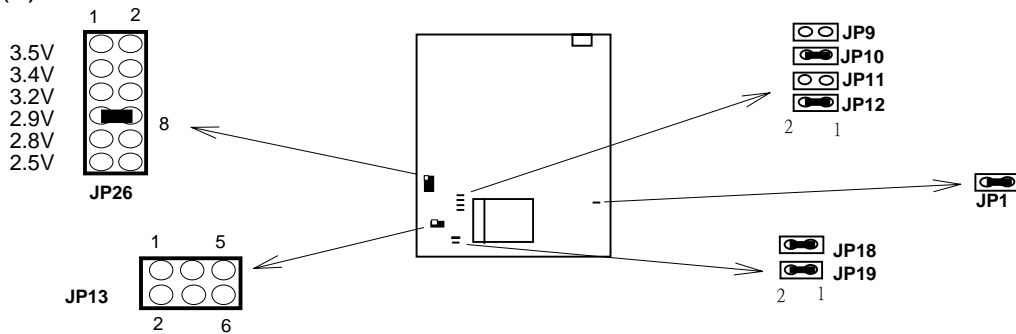

(4) 6x86MX - PR200.

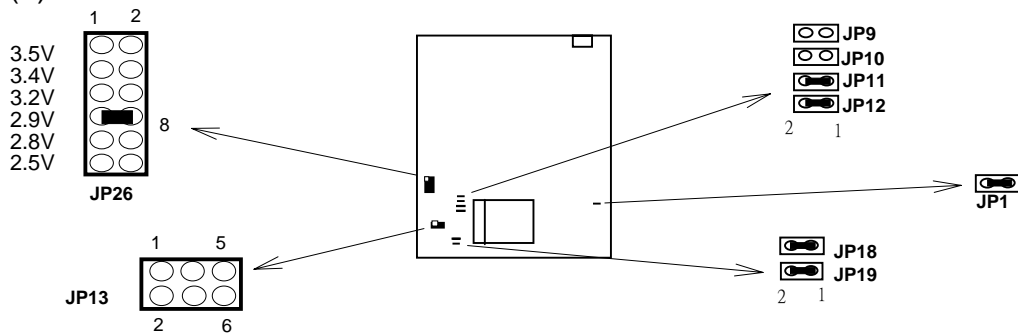

(5) 6x86MX - PR233 (66MHz)

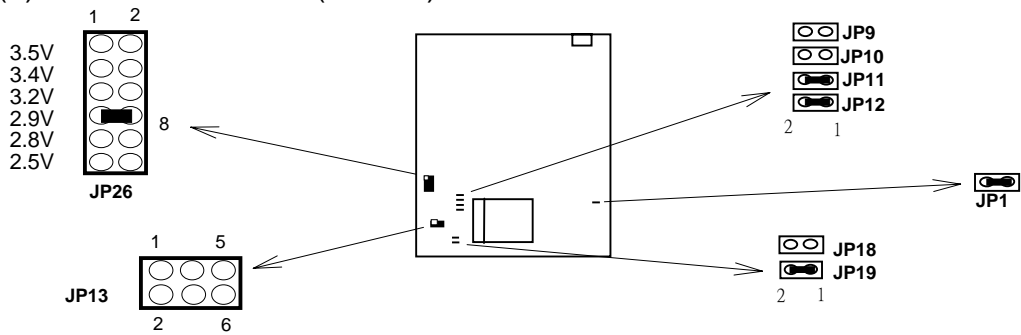

(6) 6x86MX - PR233 (75MHz).

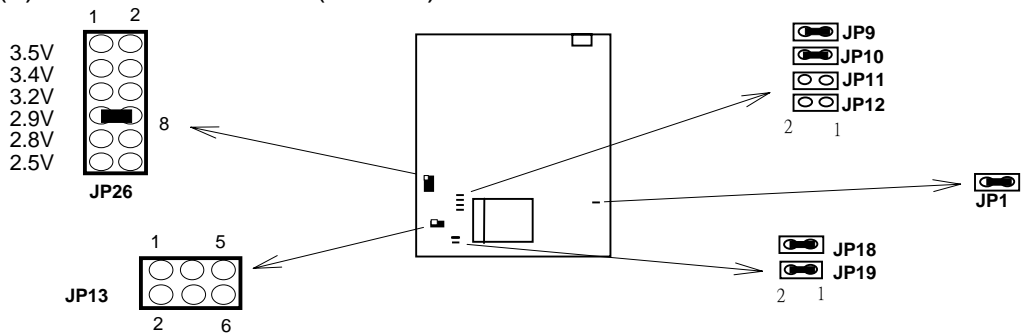

(7) 6x86MX - PR266 (66MHz).

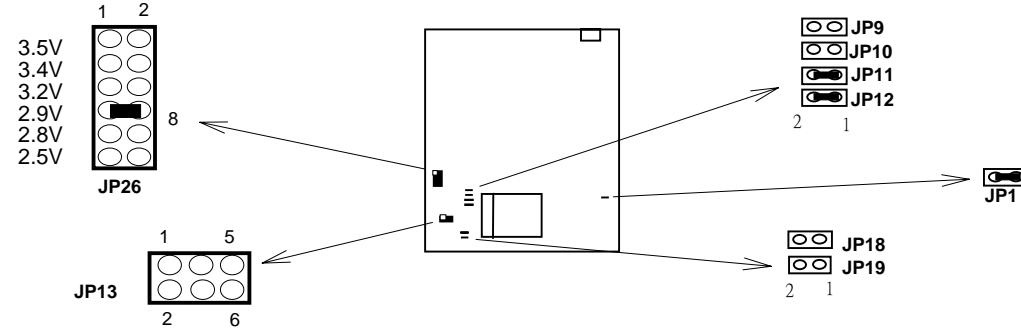

(8) 6x86MX - PR266 (75MHz).

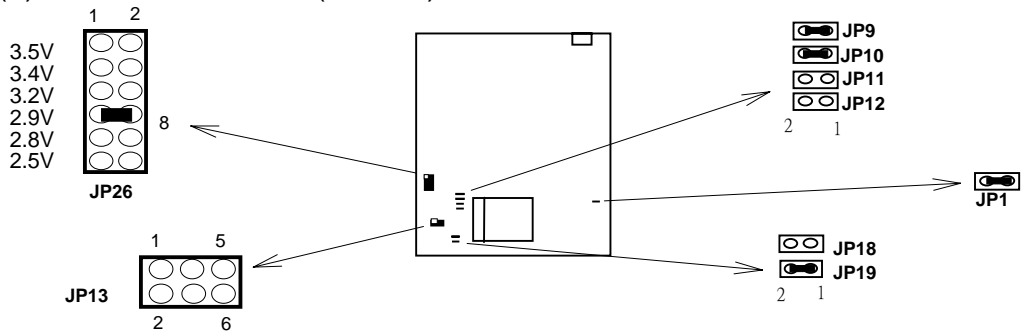

【2】

(d) AMD 5k86 & K6 CPU.

(1) AMD K5 - P90.

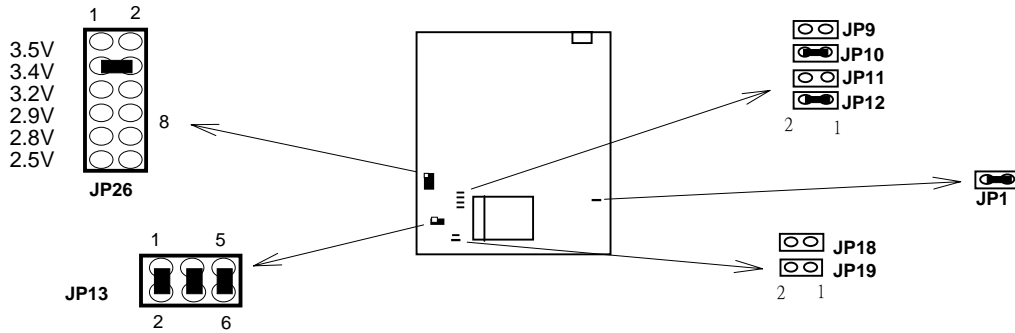

(2) AMD K5 - P100.

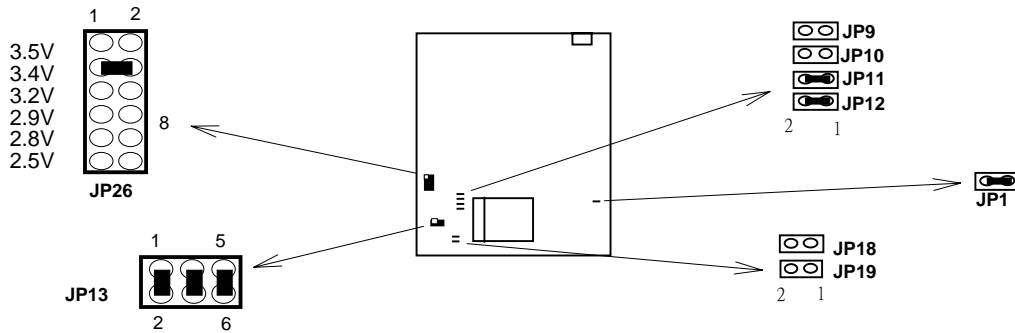

(3) AMD K5 - P166.

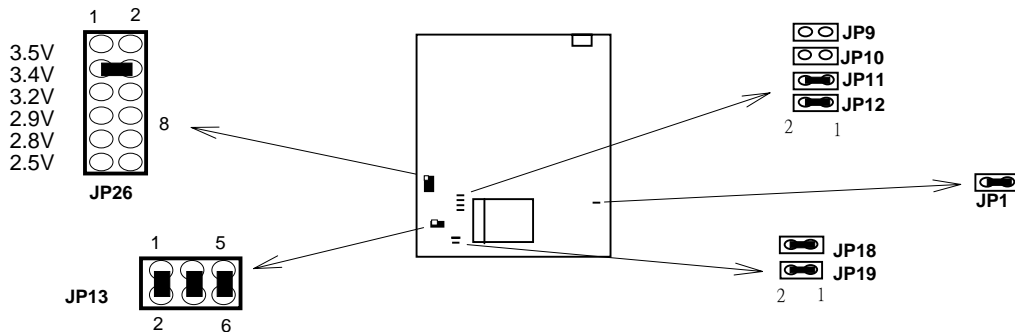

(4) AMD K6 - P166.

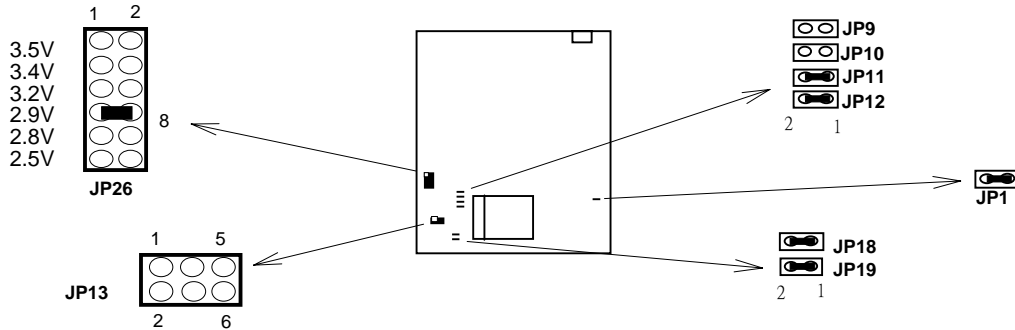

(5) AMD K6 - P200.

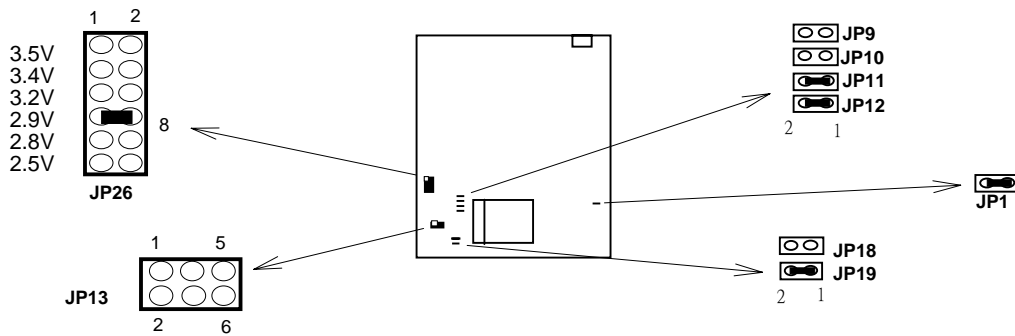

(6) AMD K6 - P233.

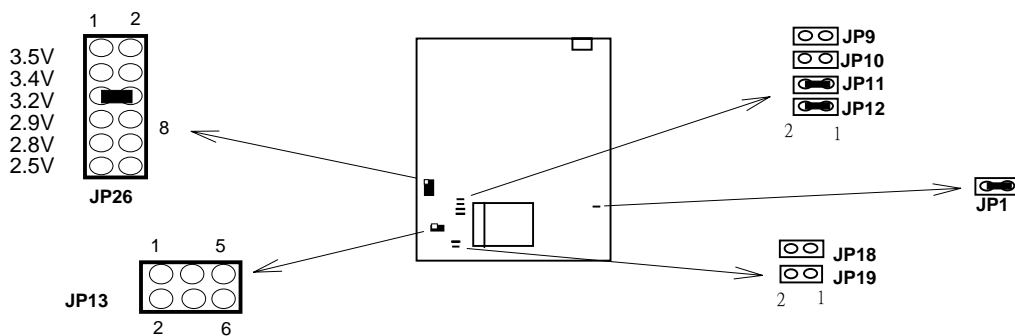

【2】

2.3.5. Installing a CPU in the ZIF Socket

The Intel Socket 7 incorporated in the mainboard specifications, is specially designed for the Pentium processor. While inserting the Pentium processor onto Socket 7, certain precautionary steps must be followed. The following diagrams of demonstration and explanation are worth of your note.

1. Make sure the ZIF socket level is up.
To raise the lever, pull it out to the side a little and raise it as far as it will go. Pin 1 is at the arm corner.

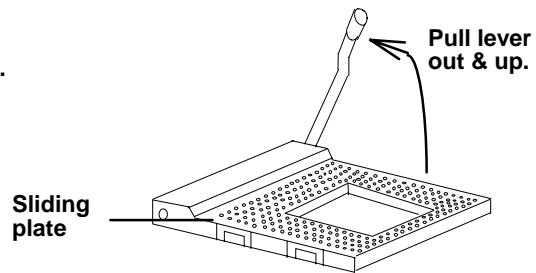

2. Align the CPU and socket pin 1 corners. match the processor corner containing the blunt edge and the white dot to the socket corner with the distinctive pin arrangement. The pins on the bottom should align with the inner 3 rings of holes in the socket, then place the CPU in the socket. It should insert easily. If it doesn't, pull the level up a little more.

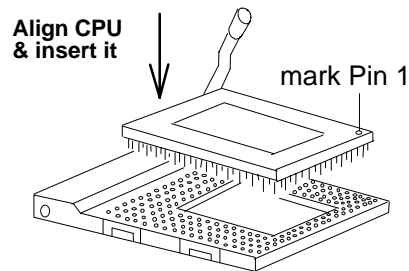

3. Press the lever down. The plate will slide forward. You will feel some resistance as the pressure starts to secure the CPU in the socket. When the CPU is installed, the lever should snap into place at the side of the socket

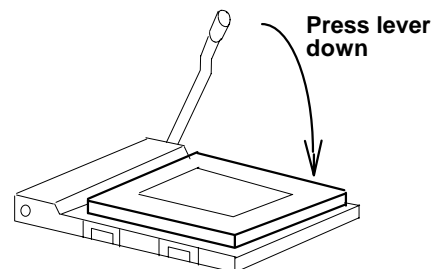

2.4 Upgrading System Memory

The R-534G mainboard can be upgraded system memory from 2MB to 384M with DRAM Type or SDRAM Type. The DRAM type can be used (1) Four 72-Pin SIMMs DRAM or (2) Two 168-Pin DIMMs DRAM Module or (3) Two 72-pin SIMMs and One 168-pin DIMMs DRAM, with Fast Page Mode (FP) and Extended Data Output Mode (EDO) at the each Banks. The same Bank must use the same type of DRAM.

You must use 2 SIMM sockets at a time (one Bank), that is. SIM 1 & SIM2 , or all four SIMM sockets at once.

Each pair of modules must be the same size and speed and can be either single or double-sided.

DRAM Type : Fast Page Mode(FP) or Extended Data Output(EDO).

DRAM Speed : 60ns or faster.

Parity : Either parity or non-parity.

2.4.1 Installing a SIMM Module

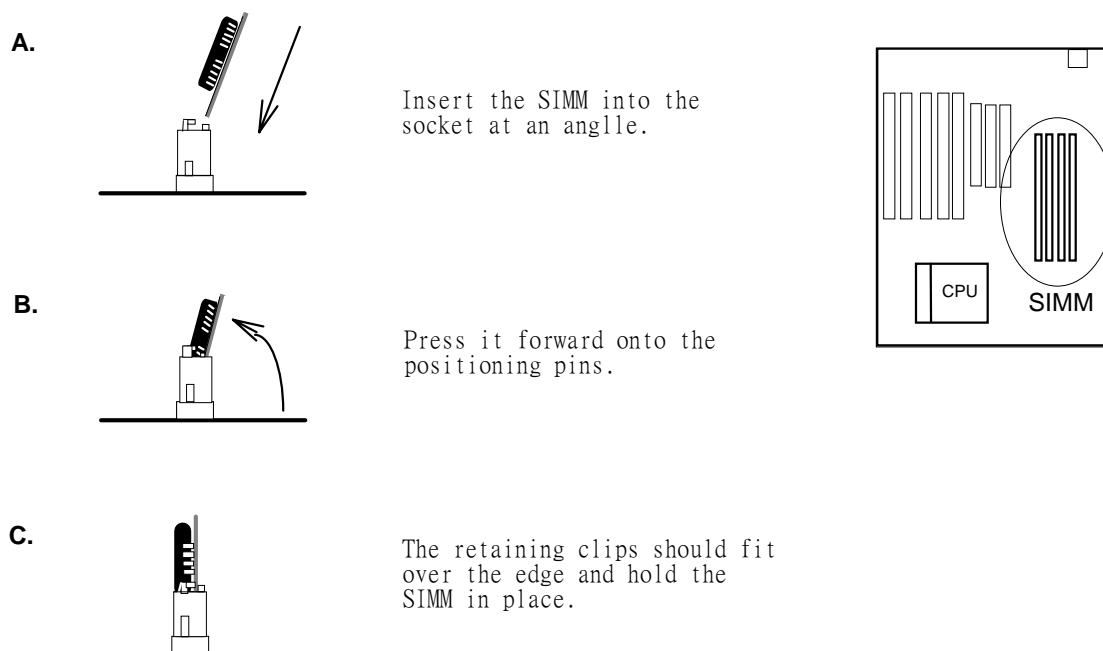

【2】

2.4.2. Installing a DIMM Module

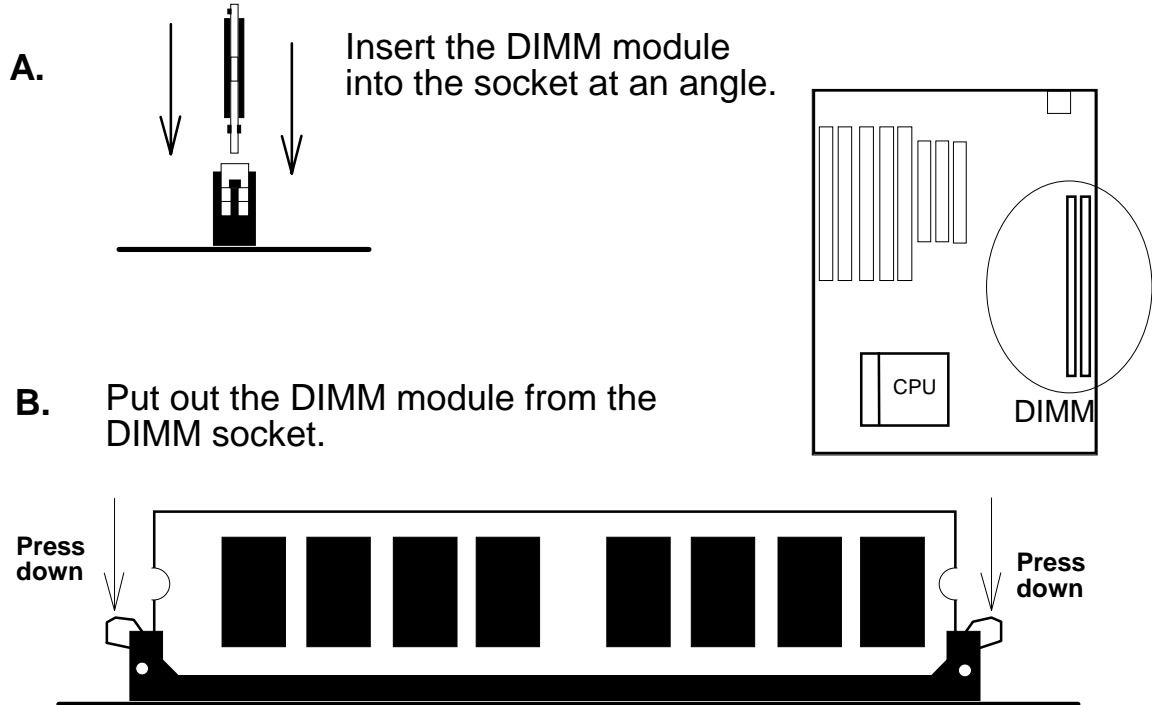

2.4.3. Memory Modules Voltage Selector : JP7, JP8.

72-pin SIMM or 168-pin DIMM Memory Selector.

Memory Voltage	JP7	JP8	Memory Type
(a) 3.3 v	2-3 Close 5-6 Close	2-3 Close 5-6 Close	168-pin SDRAM DIMM
(b) 5 v (Default)	1-2 Close 4-5 Close	1-2 Close 4-5 Close	72-pin SIMM or 168-pin DIMM DRAM

(a) 3.3 V SDRAM DIMM

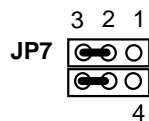
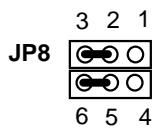

(b) 5V SIMM or DRAM DIMM

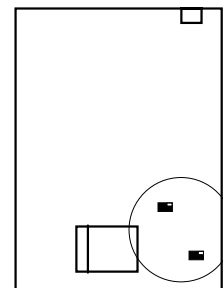
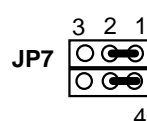
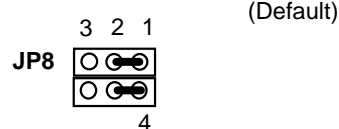

2.4.4. Memory Bank & RAM Type Selector : JP14

The expand system memory Bank from 2 Banks to 3 Banks. (DRAM Type for FP & EDO Mode only)

Default Setting : 1-3 Close, 2-4 Close.

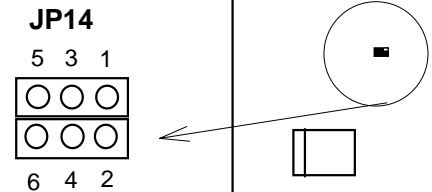

JP14	RAM Type	Bank A.	Bank B.	Bank C.
1-3 Close 2-4 Close	FP & EDO DRAM	SIM 3 & SIM 4 (or DIM 2.)	SIM 1 & SIM 2 (or DIM 1.)	X
1-3 Close 2-4 Close	SDRAM	DIM 2.	DIM 1.	X
3-5 Close 4-6 Close	FP & EDO DRAM	SIM 3 & SIM 4 (or DIM 2.)	DIM 1.	SIM 1 & SIM 2

Installing SIMMs

To install SIMMs as following instructions:

1. The modules will only insert in a socket in one orientation. An orientation cut-out will prevent you from inserting them the wrong way. See the figures at right.
2. Press the module edge connector into the socket at a moderate angle to the board. See the figures below.
3. Press the module forward onto the socket's vertical posts, so that the alignment pins at the top of each post go into the circular holes at each end of the module.
4. The module should click into place, as the retaining clips at each end of the socket snap behind the module to secure it.
5. Repeat this procedure for each module you install.

【2】

2.4.5 Memory Module Installing Table

R534G Using 72-pin SIMMs and 168-pin DIMMs DRAM Table:

Total DRAM Size	BANK A		BANK B		DIMM	
	SIM 3	SIM 4	SIM 1	SIM 2	DIM 1	DIM 2
8 MB	4 MB	4 MB	X	X	X	X
16 MB	4 MB	4 MB	4 MB	4 MB	X	X
24 MB	4 MB	4 MB	8 MB	8 MB	X	X
40 MB	4 MB	4 MB	16 MB	16 MB	X	X
72 MB	4 MB	4 MB	32 MB	32 MB	X	X
16 MB	8 MB	8 MB	X	X	X	X
24 MB	8 MB	8 MB	4 MB	4 MB	X	X
32 MB	8 MB	8 MB	8 MB	8 MB	X	X
48 MB	8 MB	8 MB	16 MB	16 MB	X	X
80 MB	8 MB	8 MB	32 MB	32 MB	X	X
32 MB	16 MB	16 MB	X	X	X	X
40 MB	16 MB	16 MB	4 MB	4 MB	X	X
48 MB	16 MB	16 MB	8 MB	8 MB	X	X
64 MB	16 MB	16 MB	16 MB	16 MB	X	X
96 MB	16 MB	16 MB	32 MB	32 MB	X	X
64 MB	32 MB	32 MB	X	X	X	X
72 MB	32 MB	32 MB	4 MB	4 MB	X	X
80 MB	32 MB	32 MB	8 MB	8 MB	X	X
96 MB	32 MB	32 MB	16 MB	16 MB	X	X
128 MB	32 MB	32 MB	32 MB	32 MB	X	X
16 MB	X	X	X	X	16 MB	X
32 MB	X	X	X	X	16 MB	16 MB
48 MB	X	X	X	X	16 MB	32 MB
32 MB	X	X	X	X	32 MB	X
64 MB	X	X	X	X	32 MB	32 MB
24 MB	4 MB	4 MB	X	X	16 MB	X
32 MB	8 MB	8 MB	X	X	16 MB	X
48 MB	16 MB	16 MB	X	X	16 MB	X
80 MB	32 MB	32 MB	X	X	16 MB	X
40 MB	4 MB	4 MB	X	X	32 MB	X
48 MB	8 MB	8 MB	X	X	32 MB	X
64 MB	16 MB	16 MB	X	X	32 MB	X
96 MB	32 MB	32 MB	X	X	32 MB	X

- ※ **Note:**
1. The 168-pin DIMMs DRAM are +5v (voltage), please refer to Page 2-18 Table (b) 5v SIMM or DIMM.
 2. " X " = Empty.

2.5 CMOS Clear Jumper: JP25

Clear the CMOS memory by momentarily shorting this Jumper; then Open the Jumper to retain new setting.

Function	JP25
Normal Operation (default)	1-2 Close
Clear CMOS data	2-3 Close

(a) Normal

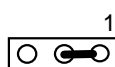

JP25

(b) Clear CMOS

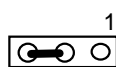

JP25

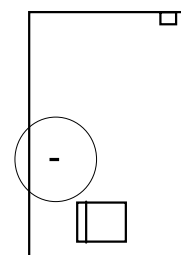

2.6 Flash EPROM Selector : JP23, JP24

Program Mode	JP23	JP24
None Flash Mode	1-2	1-2
+5V Flash ROM	1-2	2-3
+12V Flash ROM	2-3	2-3

(a) None Flash



(b) +5V Flash

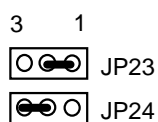

(c) +12V Flash

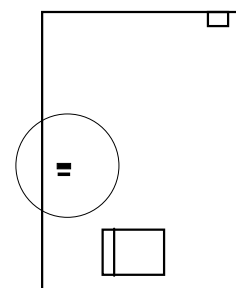
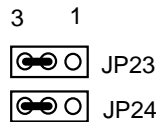

How to Update BIOS (Flash ROM)

- Copy the Flash Utility to a bootable diskette.
AWDFLASH.EXE : for AWARD BIOS.
AMIFLASH.COM : for AMI BIOS.
- Copy the new bios file to the diskette.
***.BIN : is AWARD BIOS.**
***.ROM : is AMI BIOS.**

【2】

3. Turn the power off and set BIOS Jumper to Flash Mode.

	JP23	JP24

+5V Flash ROM	1-2	2-3
+12V Flash ROM	2-3	2-3

4. Turn the system on and run the Flash utility.

5. Follow the prompt and input the file name.

6. Save the old BIOS and when prompt to program hit " Y ".

7. After the BIOS is Flash, turn off the system and clear the CMOS.

8. BIOS is Flashed.

2.7 Cache RAM Access Mode Selecter : JP5.

JP5 : Close --- For Cyrix & IBM CPU Linear Mode.

(When you selecter Linear Mode, you also must setting the Linear Mode in the BIOS SETUP Item.)

Open --- For CPU Togger Mode.

* Intel P54C & P55C(MMX) CPU only support Togger Mode.

2.8 Connectors

The Connectors are made of the same component as the jumper switches. There are connectors for the switches and indicator lights from the system case. There are also connectors for the on-board I/O port and the leads from a system power supply.

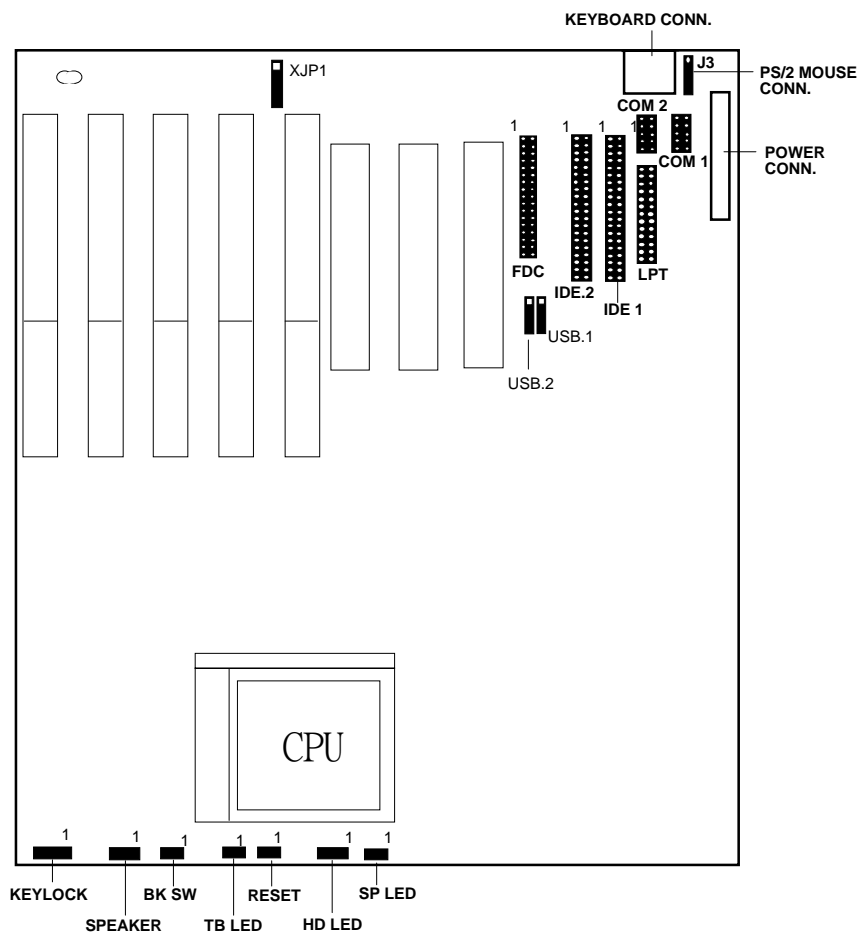

【2】

2.8.1 I/O Ports .

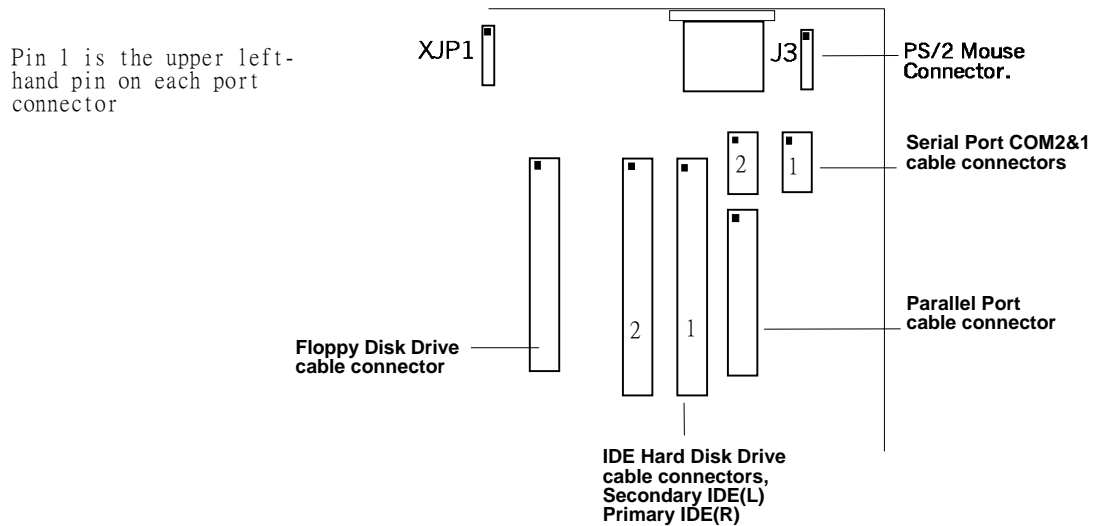

When you connect a ribbon cable to any of these I/O connectors, you must orient the cable connector so that the Pin 1 edge of the cable is at the Pin 1 end of the on-board connector.

The pin 1 edge of the ribbon cable is colored to indentify it.

Port & Controller Cables

The mainboard comes with the following cables:

- * 1 serial port and 1 parallel port ribbon cables attached to one mounting bracket.
- * 1 serial port ribbon cable with mounting bracket.
- * 1 IDE ribbon connector cables.
- * 1 floppy disk drive ribbon connector cable.
- * 1 PS/2 Mouse ribbon cable with mounting bracket.
- * 1 IR Connector (XJP1).

Connector and Port Cables

(1) Floppy Drive ribbon cable



(2) Serial ribbon cable

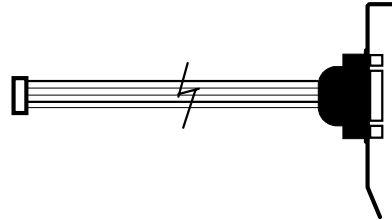

(3) IDE ribbon cable

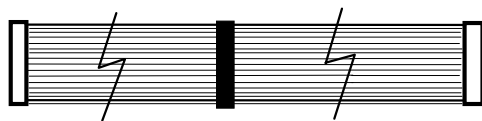

(4) Serial & Parallel ribbon cable

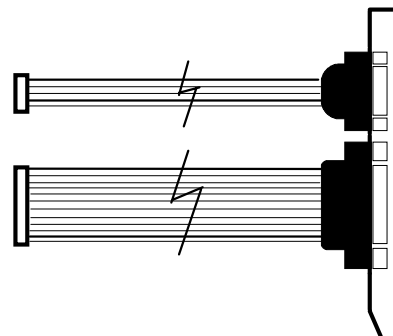

(5) PS/2 Mouse ribbon cable

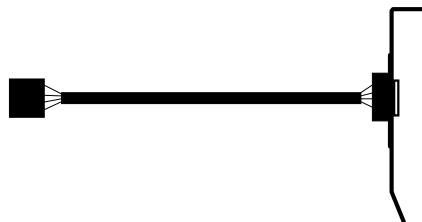
**2.8.2 External Connections**

There are several connectors on the system board for switches and indicator lights from the system case. The connectors are made of the same components as the jumper switches.

KEYLOCK	Connector for both a case-mounted lock and a Power-On LED.
SPEAKER	Connector for the lead from a speaker mounted inside the system case.
RESET	Connector for the lead from a Reset switch mounted on the system case.

【2】

TB-LED Turbo LED Connector.
Pin 1: LED –.
2: LED +.

HD LED Connector for IDE activity HDD LED.
Pin 1&4 : LED +.
2&3 : LED –.

SPLED Suspend LED Connector:
Pin 1: LED –.
2: LED +.

J1: Power Supply Connector:

The CN1 is two six-pin male header connector.
Plug the dual connectors from power directly onto
the board connector and make sure the black
leads are in the center.

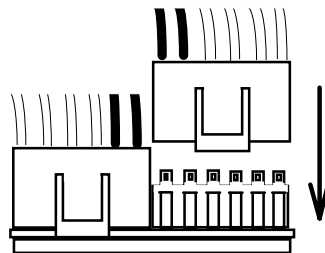

USB1, USB2 Two USB ports connector.

USB ports connector pin assignment:

Port 1: Pin 1 : SBV0.	Port 2 : Pin 1 : SBV0.
2 : SBD0-.	2 : SBD0-.
3 : SBD0+.	3 : SBD0+.
4 : SBG0.	4 : SBG0.
5 : GND.	5 : GND.

3. BIOS Setup

The mainboard's BIOS setup program is the ROM PCI/ISA BIOS from Award Software Inc. Enter the Award BIOS program's Main Menu as follows:

1. Turn on or reboot the system. After a series of diagnostic checks, you are asked to press DEL to enter Setup.
2. Press the key to enter the Award BIOS program and the main screen appears:

```
ROM PCI/ISA BIOS
CMOS SETUP UTILITY
AWARD SOFTWARE, INC.
```

STANDARD CMOS SETUP	INTEGATED PERIPHERALS
BIOS FEATURES SETUP	SUPERVISOR PASSWORD
CHIPSET FEATURES SETUP	USER PASSWORD
POWER MANAGEMENT SETUP	IDE HDD AUTO DETECTION
PNP / PCI CONFIGURATION	IDE LOW LEVEL FORMAT
LOAD SETUP DEFAULTS	SAVE & EXIT SETUP
	EXIT WITHOUT SAVING
Esc: Quit	: Select Item
F10: Save & Exit Setup	(Shift)F2: Change Color
Time, Date, Hard Disk Type...	

3. Chosse an option and press <Enter>. Modify the system parameters to reflect the options installed in the system. (See the following sections.)
4. Press <ESC> at anytime to return to the Main Menu.
5. In the Main Menu, choose "SAVE AND EXIT SETUP" to save your chang and reboot the system. Choosing "EXIT WITHOUT SAVING" ignores your changes and exits the program.

The Main Menu options of the Award BIOS are described in the sections that follow.

3.1 Standard CMOS Setup

Run the Standard CMOS Setup as follows :

1. Choose "STANDARD CMOS SETUP" from the Main Menu. A screen appears.

ROM PCI/ISA BIOS CMOS SETUP UTILITY AWARD SOFTWARE, INC									
Date (mm:dd:yy):	Fri-Feb 1		1995						
Time (hh:mm:ss):	7:30:33								
HARD DISK	TYPE	SIZE	CYLS	MEAD	PRECOMP	LANDZ	SECTOR	MODE	
Primary Master :	Auto	0	0	0	0	0	0	0	----
Primary Slave :	Auto	0	0	0	0	0	0	0	----
Secondary Master:	Auto	0	0	0	0	0	0	0	----
Secondary Slave :	Auto	0	0	0	0	0	0	0	----
Drive A: 1.44M,	3.5in.				Base	Memory:	640K		
Drive B: None					Extended	Memory:	3328K		
					Other	Memory:	128K		
					Total	Memory:	4096K		
Video:EGA/VGA									
Halt On:All Errors									
ESC:Quit	:Select				Item	PU/PD/+/-		:Modify	
F11:Help	(Shift)F2				:Change	Color	F3:Toggle		Calendar

2. Use arrow keys to move between items and select values. Modify selected fields using PgUp/PgDn/+/- keys. Some fields let you enter values directly.

- Date (mm/dd/yy)** Type the current date.
- Time (hh/mm/ss)** Type the current time.
- Primary (Secondary) Master & Slave** Choose from the standard hard disk types 1 to 46.
- Drive A & B** Type 47 is user definable. If a hard disk is not installed choose "Not installed". (default)
- Choose 360KB, 5 1/4"
1.2MB, 5 1/4"
720KB, 3 1/2"
1.4MB, 3 1/2" (Default),
2.88MB, 3 1/2" or
None
- Video** Choose Monochrome,
Color 40 X 25,
VGA/EGA (Default),
Color 80 X 25

3. When you finish, press the <ESC> key to return to the Main Menu.

3.2 BIOS Features Setup

Run the BIOS Features Setup as follows.

1. Choose "BIOS FEATURES SETUP" from the Main Menu and a screen with a list of items appears. (The screen below shows the BIOS default settings.)

ROM PCI/ISA BIOS BIOS FEATURES SETUP AWARD SOFTWARE, INC.		
CPU Internal Cache	: Enabled	Video Bios Shadow : Enabled
External Cache	: Enabled	C8000-CBFFF Shadow : Disabled
Quick Power on Self Test	: Enabled	CC000-CFFFF Shadow : Disabled
Boot Sequence	: C-A-SCSI	D0000-C#FFF Shadow : Disabled
Swap Floppy Drive	: Disabled	D4000-C7FFF Shadow : Disabled
Boot Up Numlock Status	: On	D8000-CBFFF Shadow : Disabled
Gate A20 Option	: Fast	DC000-CFFFF Shadow : Disabled
Typematic Rate Setting	: Disabled	
Typematic Rate (Chars/Sec)	: 6	
Typematic Delay (Msec)	: 250	
Security Option	: Setup	
PCI/VGA Palette Snoop	: Disabled	
OS Select for DRAM >64MB	: Non-OS2	
		ESC: Quit :Select Item
		F1: Help PU/PD/+/- :Modify
		F5: Old Values (Shift)F2:Color
		F6: Load BIOS Defaults
		F7: Load Setup Defaults

2. Use the arrow keys to move between items and to select values. Modify the selected fields using the PgUp/PgDn/+/- keys. <F> keys are explained below:

<F1>: "Help" gives options available for each item.

Shift<F2>: Change color.

<F5>: Get the old values. These values are the values with which the user started the current session.

<F6>: Load all options with the BIOS Setup default values.

<F7>: Load all options with the Power-On default values.

A short description of screen items follows:

CPU Internal Cache	This option enables/disables the CPU's internal cache. (The Default setting is Enabled.)
External Cache	This option enables/disables the external cache memory. (The Default setting is Enabled.)
Quick Power On Self Test	Enabled provides a Fast POST at boot-up.
Boot Sequence	The default setting attempts to first boot from drive C: and then from Floppy disk A: You can reverse this sequence.
Swap Floppy Drive	Enabled changes the sequence of the A: and B: drives. (The Default setting is Disabled.)
Boot Up Num Lock Status	Choose On or Off. On puts numeric keypad in Num Lock mode at boot-up. Off puts this keypad in arrow key mode at boot-up.
Gate A20 Option	Choose Fast (default) or Normal. Fast allows RAM accesses above 1MB using the fast gate A20 line.
Typematic Rate Setting	Enable this option to adjust the keystroke repeat rate.
Typematic Rate (Chars/Sec)	Choose the rate a character keeps repeating.
Typematic Rate (Msec)	Choose how long after you press a key that a character begins repeating.

Security Option Choose Setup or System. Use this feature to prevent unauthorized system boot-up or use of BIOS Setup.

"System"-Each time the system is booted the password prompt appears.

"Setup"- If a password is set, The password Prompt only appears if you attempt to enter the Setup program.

PCI/VGA Palette Snoop Enable : The color of the monitor may be incorrect if uses with MPEG card. Enable this option to make the monitor normal.

Disable: Default setting.

OS Select for DRAM >64MB OS2: Choosing this when you are using OS/2 operation system.

Non-OS/2: Choosing this when you are using no-OS/2 operation system.

Video or Adapter BIOS Shadow BIOS shadow copies BIOS code from slower ROM to faster RAM. BIOS can then execute from RAM. 16K segments can be shadowed from ROM to RAM. BIOS is shadowed in a 16K segment if it is enable and it has BIOS present.

3. After you have finished with the BIOS Features Setup program, Press the <ESC> key and follow the screen instructions to save or disregard your settings.

3.3 Chipset Features Setup

The Chipset Features Setup option changes the values of the Chipset registers. These registers control system options in the computer.

Note: Change these settings only if you are familiar with the Chipset.

Run the Chipset Features Setup as follows.

1. Choose "CHIPSET FEATURES SETUP" from the Main Menu and the following screen appears. (The screen below shows default settings.)

ROM PCI/ISA BIOS CHIPSET FEATURES SETUP AWARD SOFTWARE, INC			
Auto Configuration	: Enabled	System BIOS Cacheable	: Enabled
ISA Bus Clock Frequency	: PCICLK/4	Video BIOS Cacheable	: Enabled
L2 Cache Update Mode	: WB	Memory Hole at 15M-16M	: Disabled
L2 (WB) Tag Bit Length	: 8 bits	Linear Mode SRAM Support	: Disabled
SRAM Back-to-Back	: Enabled		
Refresh Cycle Time (us)	: 62.4		
RAS Pulse Width Refresh	: 5T		
MDLE Delay (ns)	: 3		
CAS# Pulse Width (FP)	: 2T		
SDRAM WR Retire Rate	: X-2-2-2		
CPU to PCI Post Write	: 3T		
Read Prefetch Memory RD	: Disabled		
CPU to PCI Burst Mem. WR	: Disabled		
		ESC : Quit	:Select Item
		F1 : Help	PU/PD/+/-:Modify
		F5 : Old Values (Shift)	F2:Color
		F7 : Load Setup Defaults	

2. Use the arrow keys to move between items and select values.

Modify selected fields using the PgUp/PgDn/+/- keys.

A short description of screen items follows:

Auto Configuration Enable this option (strongly recommended) and the system automatically sets all options on the left side of the screen (except cache update mode & BIOS cacheable).

ISA Bus Clock Frequency Use BIOS default setting or choose:

/4: for 60, 66MHz CPU Bus Frequency.

/3: for 50, 55MHz CPU Bus Frequency.

L2 Cache Update Mode	Use the default setting.
L2 (WB) Tag Bit Length	Use the default setting.
SRAM Back-to-Back	Pipeline burst SRAM Back to Back read timing (use the default setting)
Refresh Cycle Time (us)	Use the default setting.
RAS Pulse Width Refresh	Use the default setting.
MDLE Delay (us)	Memory Data delay time.
CAS# Pulse Width (FP)	Use the default setting.
SDRAM WR Retire Rate	Use the default setting.
CPU to PCI Post Write	Use the default setting.
Read Prefetch Memory RD	Use the default setting.
CPU to PCI Burst Mem. WR	Use the default setting.
System BIOS Cacheable	Disable : The ROM area F0000H-FFFFFFH is not cached. Enable : The ROM area F0000H-FFFFFFH is cachable if cache controller is enable.

Video BIOS Cacheable

Disable : The video BIOS C0000H-C7FFFH is not cached.

Enable : The video BIOS C0000H-C7FFFH is cachable if cache controller is enable.

**Memory Hole At
15M-16M**

Choose Enabled or Disabled (default). Some interface cards will map their address to this area. If this occurs, you should select Enabled, otherwise use Disabled.

Linear Mode SRAM Support When use the Cyrix or IBM CPU, System support Linear Mode.(JP5: must set to Close).

3. After you have finished with the Chipset Features Setup, press the <ESC> key and follow the screen instructions to save or disregard your settings.

The Power Management Setup option sets the system's power saving function.

Run the Power Management Setup as follows.

1. Choose "POWER MANAGEMENT SETUP" from the Main Menu and a screen with a list of items appears.

ROM PCI/ISA BIOS POWER MANAGEMENT SETUP AWARD SOFTWARE, INC			
Power Management	:Disabled	IRQ 3 (COM 2)	:Enabled
PM Control by APM	:Yes	IRQ 4 (COM 1)	:Enabled
Video Off Option	:Susp-Stby -> Off.	IRQ 5 (LPT 2)	:Enabled
Video Off Method	:V/M SYNC+Blank	IRQ 6 (Floppy Disk)	:Enabled
Switch Function	:Deturbo	IRQ 7 (LPT 1)	:Enabled
		IRQ 8 (RTC Alarm)	:Disabled
		IRQ 9 (IRQ2 Redir)	:Disabled
MODEM Use IRQ	:3	IRQ 10 (Reserved)	:Disabled
		IRQ 11 (Reserved)	:Disabled
		IRQ 12 (PS/2 Mouse)	:Enabled
** PM Timers **		IRQ 13 (Coprocesor)	:Enabled
HDD Off After	:Disable	IRQ 14 (Hard disk)	:Enabled
Doze Mode	:Disable	IRQ 15 (Reserved)	:Enabled
Standby Mode	:Disable		
Suspend Mode	:Disable		
		ESC: Quit	:Select Item
** PM Events **		F1: Help	PU/PD/+/- :Modify
COM Ports Activity	:Enabled	F5: Old Values (Shift)	F2: Color
LPT Ports Activity	:Enabled	F7: Load Setup Defaults	
HDD Ports Activity	:Enabled		
VGA Activity	:Disabled		

2. Use the arrow keys to move between items and to select values. Modify the selected fields using the PgUp/PgDn/+/- keys.

A short description of selected screen items follows:

Power Management Options are as follows:

User Define Let's you define the HDD and system Power down times.

Disabled Disabled the green PC Features.

PM Control by APM Choose Yes or No (default). APM stands for advanced Power Management. To use APM you must run "power.exe" under DOS V6.0 or later version.

Video Off Method	Choose V/H Sync + Bland (default), Bland screen, or DPMS for the selected PM mode.
Switch Function	Setting the jumper "TW-SW" for Deturbo or Break Mode.
Doze Mode	When the set time has elapsed, the BIOS sends a command to the system to enter doze mode. Time is adjustable from 1 Min to 1 Hour.
Standby Mode	The default is Disabled. Time is adjustable from 1 Min to 1 Hour.
Suspend Mode	The default is Disabled. Only an SL-Enhanced (or SMI CPU can enter this mode. Time is adjustable from 1 Mi to 1 Hour. Under Suspend mode, the CPU stops completely (no instructions are executed).
HDD Power Down	When the set time has elapsed, the BIOS sends a command to the HDD to power down, which turns off the motor. Time is adjustable from 1 to 15 minutes. the default setting is Disabled. Some older model HDD may not supports this advanced function.
IRQx (Wake-Up Events) Power Down Activities	The BIOS monitors these items for activity. If activity occurs from the Enabled item the system wakes up. The BIOS monitors these items for no activity. If no activity occurs from the Enabled item the system will enter power saving mode (Doze/Standby/Supend/HDD Power Down mode)

3. After you have finished with the Power Management Setup, Press the <ESC> key to return to the Main Menu.

3.5 PNP/PCI Configuration Setup

This option sets the mainboard's PCI Slots. Run this option as follows:

1. Choose "PNP/CPI CONFIFURATION SETUP" from the Main Menu and the following screen appears. (The screen below shows default settings.)

ROM PCI/ISA BIOS
PNP/PCI CONFIGURATION
AWARD SOFTWARE, INC.

Resources Controlled By : Manual Reset Configuration Data: Disabled	PCI IRQ Actived By : Level PCI IDE Map To : PCI-Auto Primary IDE INT# : A Secondary IDE INT# : A
IRQ-3 assigned to : Legacy ISA IRQ-4 assigned to : Legacy ISA IRQ-5 assigned to : PCI/ISA PnP IRQ-7 assigned to : Legacy ISA IRQ-9 assigned to : PCI/ISA PnP IRQ-10 assigned to : PCI/ISA PnP IRQ-11 assigned to : PCI/ISA PnP IRQ-12 assigned to : PCI/ISA PnP IRQ-14 assigned to : Legacy ISA IRQ-15 assigned to : Legacy ISA DMA-0 assigned to : PCI/ISA PnP DMA-1 assigned to : PCI/ISA PnP DMA-3 assigned to : PCI/ISA PnP DMA-5 assigned to : PCI/ISA PnP DMA-6 assigned to : PCI/ISA PnP DMA-7 assigned to : PCI/ISA PnP	ESC: Quit :Select Item F1 : Help PU/PD/+/- :Modify F5 : Old Values (Shift)F2 : Color F6 : Load BIOS Defaults F7 : Load Setup Defaults

* These items will disappear when Resource Controlled is Auto.

2. Use the arrow keys to move between items and select values. Modify selected fields using the PgUp/PgDn/+/- keys.

A short description of screen items follows:

Resources Controlled By Manual: BIOS doesn't manage PCI/ISA PnP card (i.e.,IRQ) automatically.
Auto : BIOS auto manage PCI/ISA PnP card (recommended)

Reset Configuration Data Disabled: Retain PnP configuration data in BIOS.
Enabled: Reset PnP configuration data in BIOS.

【3】

IRQx and DMAx assigned to Choose PCI/ISA PnP or Legacy ISA, If the first item is set Manual, you could choose IRQX and DMAX assigned to PCI/ISA PnP card or ISA card.
PCI/ISA PnP: BIOS auto assigns IRQ/DMA to the devi
Legacy ISA: User assigns IRQ/DMA to the device.

PCI IRQ Activated By Choose Edge or Level. Most PCI trigger signals are Level. This setting must match the PCI card.

PCI IDE IRQ Map To Select PCI-AUTO, ISA, or assign a PCI SLOT number (depending on which slot the PCI IDE is inserted.)
The default setting is PCI-AUTO. If PCI-AUTO does not work, then assign an individual PCI SLOT number.

Primary IDE INT# Choose INTA#, INTB#, INTC#, or INTD#. the default setting is INTA#

Secondary IDE INT# Choose INTA#, INTB#, INTC#, or INTD#. the default setting is INTB#.

3. After you have finished with the PCI Slot configuration, press the <ESC> key and follow the screen instructions to save or disregard your settings.

3.6 Load Setup Defaults

This item loads the system values you have previously saved. Choose this item and the following message appears:

"Load SETUP Defaults (Y/N)? N"

To use the SETUP defaults, change the prompt to "Y" and press <Enter>.

This item is recommended if you need to reset the system setup.

3.7 Integrated Peripherals

The Integrated Peripherals option changes the values of the Chipset registers. These registers control system options in the computer.

Note: Change these settings only if you are familiar with the Chipset.

Run the Integrated Peripherals as follows.

1. Choose "Integrated Peripherals" from the Main Menu and the following screen appears. (The screen below shows default settings.)

ROM PCI/ISA BIOS INTEGRATED PERIPHERALS AWARD SOFTWARE, INC.	
Internal PCI/IDE :Both	PS/2 mouse function : Enabled
IDE Primary Master PIO :Mode 2	
IDE Primary Slave PIO :Auto	
IDE Secondary Master PIO :Auto	
IDE Secondary Slave PIO :Auto	
IDE Burst Mode :Disabled	
IDE Data Port Post Write :Enabled	
IDE HDD Block Mode :Enabled	
Onboard FDD Controller :Enable	
Onboard Serial Port 1 :Auto	
Onboard Serial Port 2 :Auto	
Onboard Parallel Port :378/IRQ7	ESC: Quit :Select Item
Onboard Parallel MODE :SPP	F1 : Help PU/PD/+/- :Modify
	F5 : Old Values (Shift)F2 : Color
	F6 : Load BIOS Defaults
	F7 : Load Setup Defaults

2. Use the arrow keys to move between items and select values. Modify selected fields using the PgUp/PgDn/+/- keys.

A short description of screen items follows:

- Internal PCI/IDE** Choose Enabled (default) or Disabled On-board IDE.
- IDE Primary Master PIO** Choose Auto (default) or mode 0-4. Mode 0 is the slowest speed, and HDD mode 4 is the
- IDE Primary Slave PIO**

3-13

【3】

- IDE Secondary Master PIO** fastest speed. For better performance and we
- IDE Secondary Slave PIO** stability, suggest you use the Auto setting to set the HDD control timing.
- Onboard FDD Controller** Enable: Use the on-board floppy controller (default).
Disable: Turn off the on-board floppy controller

Onboard Serial Port 1	Choose Serial port 1 & 2's I/O address. Do not set port 1 & 2 to the same value except for Disabled.
Onboard Serial Port 2	
	COM 1/3F8H COM3/3E8H COM 2/2F8H COM4/2E8H (default)
Onboard Parallel Port	Choose the printer I/O address: 378H/IRQ7(default), 278H/IRQ5, 3BCH/IRQ
Onboard Parallel Mode	Choose ECP + EPP, SPP(default) or EPP, ECP mode. The mode depends on your external device that connects to this port.
PS/2 Mouse function	Selected on board PS/2 Port enabled or disabled.

- After you have finished with the Integrated Peripherals, press the <ESC> key and follow the screen instructions to save or disregard your settings.

3.8 Supervisor Password

Base on the setting you made in the "security Option" of the "BIOS FEATURES SETUP", This Main Menu item lets you configure the system so that a password is required every time the system boots or an attempt is made to enter the Setup program. Change the password as follows:

1. Choose "SUPERVISOR PASSWORD " in the Main Menu and Press <Enter>.

The following message appears:

"Enter Password:"

2. Enter a password and press <Enter>.
(If you do not wish to use the password function, you can just press <Enter> and a "Password disabled" message appears.)
3. After you enter your password, the following message appears prompting you to confirm the new password:

"Confirm Password"

4. Re-enter your password and then Press <ESC> to exit to the Main Menu.
5. You have the right to change any changeable settings in the "COMS SETUP UTILITY."

Important : If you forget or lose the password, the only way to access the system is to set jumper JP38 to clear the CMOS RAM. all setup information is lost and you must run the BIOS setup program again.

3.9 User Password

Base on the setting you made in the "security Option" of the "BIOS FEATURES SETUP", This Main Menu item lets you configure the system so that a password is required every time the system boots or an attempt is made to enter the Setup program. Change the password as follows:

1. Choose "USER PASSWORD " in the Main Menu and Press <Enter>. The following message appears:

"Enter Password:"

2. Enter a password and press <Enter>. (If you do not wish to use the password function, you can just press <Enter> and a "Password disabled" message appears.)
3. After you enter your password, the following message appears prompting you to confirm the new password:

"Confirm Password"

4. Re-enter your password and then Press <ESC> to exit to the Main Menu.
5. You are not allowed to change any settings in the "COMS SETUP UTILITY." except change user's password.

Important : If you forget or lose the password, the only way to access the system is to set jumper JP38 to clear the CMOS RAM. all setup information is lost and you must run the BIOS setup program again.

3.10 IDE HDD Auto Detection

This Main Menu item automatically detects the hard disk type and configures the STANDARD CMOS SETUP accordingly.

Note: This function is only valid for **IDE** hard disks.

ROM PCI/ISA BIOS
CMOS SETUP UTILITY
AWARD SOFTWARE, INC.

HARD DISK	TYPE	SIZE	CYLS	HEAD	PRECOMP	LANDZ	SECTOR	MODE
Primary Master	:None	0	0	0	0	0	0	0
Primary Slave	:None	0	0	0	0	0	0	0
Secondary Master	:None	0	0	0	0	0	0	0
Secondary Slave	:None	0	0	0	0	0	0	0

Do your accept this drive C (Y/N)?N

ESC : Skip