

PX845PE / GE Series

Copyright

All rights are reserved. No part of this publication may be reproduced, transmitted, transcribed, stored in a retrieval system or translated into any language or computer language, in any form or by any means, electronic, mechanical, magnetic, optical, chemical, manual or otherwise, without the prior written permission of the company. Brands and product names are trademarks or registered trademarks of their respective companies.

The vendor makes no representations or warranties with respect to the contents herein and especially disclaim any implied warranties of merchantability or fitness for any purpose. Further the vendor reserves the right to revise this publication and to make changes to the contents herein without obligation to notify any party beforehand. Duplication of this publication, in part or in whole, is not allowed without first obtaining the vendor's approval in writing.

Disclaimer

We make no warranty of any kind with regard to the content of this user's manual. The content is subject to change without notice and we will not be responsible for any mistakes found in this user's manual. All the brand and product names are trademarks of their respective companies.

FCC Compliance Statement

This equipment has been tested and found to comply with the limits of a Class B digital device, pursuant to Part 15 of the FCC Rules. These limits are designed to provide reasonable protection against harmful interference in a residential installation. This equipment generates, uses and can radiate radio frequency energy and, if not installed and used in accordance with the instructions, may cause harmful interference to radio communications. Operation of this equipment in a residential area is likely to cause harmful interference in which case the user will be required to correct the interference at his own expense. However, there is no guarantee that interference will not occur in a particular installation.

PX845PE / GE Series

Intel® 82845PE/GE & 82801DB
Supports Socket 478 Intel® Pentium® 4 Processor

Enabling the functionality of Hyper-Threading Technology for your computer system requires ALL of the following platform

Components

- **CPU:** An Intel® Pentium® 4 Processor with HT Technology
- **Chipset:** An Intel® Chipset that supports HT Technology
- **BIOS:** A BIOS that supports HT Technology and has it enabled
- **OS:** An operating system that supports HT Technology

For more information on Hyper-Threading Technology, go to:
www.intel.com/info/hyperthreading

Contents

CHAPTER 1. GETTING STARTED	1
INTRODUCTION	1
SPECIFICATION	2
QUICK CONTENT TABLE	7
CONFIGURATION	8
HARDWARE INSTALLATION	14
CHAPTER 2. BIOS SETUP	32
INTRODUCTION	32
MAIN MENU	34
ADVANCED BIOS FEATURES	36
INTEGRATED PERIPHERALS	42
POWER MANAGEMENT	46
HARDWARE MONITOR	49
LOAD DEFAULTS	49
EXIT MENU	50
CHAPTER 3: SOFTWARE SETUP	51
SOFTWARE LIST	51
SOFTWARE INSTALLATION	51
SUPER 5.1 CHANNEL SETUP	53
SPEAKER TEST	53
CHAPTER 4: TROUBLESHOOTING	54

Chapter 1. Getting Started

Introduction

Congratulations on choosing the PX845PE/GE Series mainboard! The PX845PE series includes the PX845PE and PX845PE PRO and PX845PE PRO II. The PX845GE series includes the PX845GE and PX845GE PRO and PX845GE PRO II. These are based on either the 82845PE or 82845GE Northbridge chipsets and the 82801DB Southbridge chipset. It also supports Intel® Pentium® 4 Processors with a FSB (Front Side Bus) frequency of 400/533 MHz.

The PX845PE/GE Series provides 3 sockets using 184 pin DDR SDRAM with a total capacity of up to 2GB. You can install DDR 333/266 (PC 2700/2100) SDRAM with the option of using the BIOS Setup to over-clock to DDR400.

The PX845PE/GE Series provides one AGP Slot for 4X and 1.5V only AGP cards.

The PX845PE/GE Series includes built in IDE facilities that support Ultra DMA 33/66/100 BMIDE and PIO Modes. The PX845PE/GE Series also comes with an AC'97 Sound Codec (ALC650) which supports high quality 6 channel audio (**Super 5.1 Channel Audio Effect**).

The PX845PE PRO/ PX845PE PRO II/ PX845GE PRO/ PX845GE PRO II also includes a Promise chip that supports one RAID IDE connector and two SATA connectors. The RAID IDE connector supports Ultra 133 and the SATA connectors support Serial ATA 150.

The PX845PE/GE Series also comes with six USB 2.0 ports.

The PX845PE PRO II/ PX845GE PRO II comes preinstalled with **Voice Genie / BIOS Mirror** and **AGP Protection** that controlled by a switch. Voice Genie allows you to select between four languages for audio diagnostics. BIOS Mirror allows you to have a backup (mirror) BIOS when the primary BIOS is damaged by virus or flash update. The PX845PE/GE Series also come with AGP protection with ensures that you only install 1.5V AGP cards.

PX845PE PRO II & PX845GE PRO II also comes with a LAN Chip (Intel DA82562ET) which supports a back panel LAN port.

Specification

CPU:

- Supports Socket 478 Pentium® 4 processor
- Supports Hyper Threading Technology

Speed:

- 400/533 MHz Front Side Bus frequency
- Supports core speeds up to 2.8 GHz CPU
- 33MHz, 32 bit PCI interface (PCI 2.2 compliant)
- 66MHz AGP 2.0 compliant interface that supports 4X data transfer modes (1.5V only)

Chipset:

- Northbridge Chip (MCH) – Intel 82845PE (for PX845PE series) / Intel 82845GE (for PX845GE series)
- Southbridge Chip (ICH) – Intel 82801DB (ICH4)
- I/O Controller – Winbond IO W83627HF
- AC'97 Codec – Realtek ALC650
- Promise FastTrak Controller Chip – Promise PDC20376 (for PX845PE/GE PRO & PX845PE/GE PRO II)

DRAM Memory:

- Supports 333 (PC2700) / 266(PC2100) DDR (Double Data Rate) SDRAM
- Supports 64 MB/ 128 MB/ 256 MB/ 512 MB/ 1 GB unbuffered non-ECC DIMM modules
- Supports up to three single-sided or two double-sided memory modules with a total capacity of 2 GB (see memory installation section for more details)
- Does not support double-sided *16 DDR DIMMs

Green Functionality:

- Supports Phoenix-Award BIOS™ power management functionality
- Wakes from power saving sleep mode with any keyboard or mouse activity

Shadow RAM:

- This mainboard is equipped with a memory controller providing shadow RAM and support for ROM BIOS

Graphics Controller: (only for PX845GE series)

- Integrated 2D/3D graphics accelerator
- 256-bit graphics core
- Texture mapped 3D with point sampled, Billnear, Trilinear, and Anisotropic filtering
- Hardware setup with support for strips and fans
- Hardware motion compensation assistance for software MPEG/DVD decode
- Intel Digital Video (DVO) ports support digital displays and TV-out
- Integrated 350 MHz RAMDAC
- Support ADD cards

BUS Slots:

- 1 AGP slot (4X/1.5V only)
- Six 32-bit PCI bus slots (5 master slots => PCI 1-5)**
- Six 32-bit PCI bus slots (6 master slots)*

*Only for PX845PE/GE

**for PX845PE/GE PRO & PRO II

Flash Memory:

- Supports flash memory functionality
- Supports ESCD functionality

Hardware Monitor Function:

- Monitors CPU Fan/ Chassis Fan/ Peripheral Fan Speed
- Monitors System Voltage

Infrared:

- Supports IrDA Version 1.0 SIR Protocol with a maximum baud rate of up to 115.2 Kbps
- Supports SHARP ASK-IR Protocol with maximum baud rate of up to 57600 bps
- Supports Consumer IR with Wake-Up function

AC'97 Sound Codec Onboard:

- High performance CODEC with high S/N ratio (>90dB)
- Compliant with AC'97 2.2 specification
- 6-channel playback capability (Super 5.1 Channel Audio Effect)
- 3D Stereo enhancement
- Digital S/PDIF OUT/ IN

I/O facilities:

- One multi-mode Parallel Port capable of supporting the following specifications:
 1. Standard & Bi-direction Parallel Port
 2. Enhanced Parallel Port (EPP)
 3. Extended Capabilities Port (ECP)
- Supports two serial ports, 16550 UART
- Supports one VGA port (only for PX845GE series)
- Supports Infrared Data Transmission using IrDA
- Supports PS/2 mouse and PS/2 keyboard
- Supports 360 KB, 720 KB, 1.2 MB, 1.44 MB, and 2.88 MB floppy disk drives
- MIDI compatible
- Game port compatible

IDE Facilities:

- Supports Ultra ATA 33, Ultra ATA 66, Ultra ATA 100, BMIDE and PIO modes
- Supports IDE interface with CD-ROM
- Supports high capacity hard disk drives
- Supports installation of up to 4 drives, with separate IDE connections for Primary and Secondary connectors

RAID IDE facilities: (for PX845PE/GE PRO & PX845PE/GE PRO II)

- Supports RAID 0 or RAID 1, RAID 0 & RAID 1 non-coexist
- Supports Ultra ATA 133 specification
- Do not support ATAPI Devices.

For more details please refer to Promise FastTrak 376 Controller USER's Manual.

**Serial ATA facilities:
(for PX845PE/GE PRO & PX845PE/GE PRO II)**

- Compatible with SATA Spec 1.0
- Supports Serial ATA specification of 150 MB/sec transfers with CRC error-checking
- Supports SATA drives hot plugging capability

For more details please refer to Promise FastTrak 376 Controller USER's Manual.

Universal Serial Bus:

- Supports six USB 2.0 ports for USB interface devices

BIOS:

- Phoenix-Award™ BIOS
- Supports APM1.2
- Supports USB Legacy function
- Supports ACPI power management
- Supports “BIOS Mirror” technology (only for PX845PE/GE PRO II)

Voice Genie: (only for PX845PE/GE PRO II)

- Voice Genie can generate audio diagnostics in 4 different languages (English 、 Chinese 、 Japanese 、 German)

AGP protection:

- This mainboard provides an AGP slot only for 1.5V AGP cards. The AGP protection function is to protect the mainboard and AGP cards if a non 1.5V card is installed.

LAN: (only for PX845PE/GE PRO II)

- Supports 10/100 Mbit/ s Ethernet
- Does not support “Alert On LAN” function
- Supports PME wake up
- Supports LAN boot

Watch Dog Timer:

- This mainboard contains a special feature called the “Watch Dog Timer” which is used to detect when the system is unable to handle over-clocking configurations during POST stage. Once detected the system will reset the configurations and reboot the system after five seconds.

Operating System:

- Supports most popular operating systems: Windows® 9X/ME/2000/XP, etc.

Dimensions (ATX form-factor):

- 244mm x 305mm (WxL)

Package Contents:

- IDE Cable
- FDC Cable
- USB Bracket (only for PX845PE/GE PRO II)
- SPDIF & Front Audio dual-function Bracket (only for PX845PE/GE PRO II)
- Installation and Setup Driver CD
- PX845PE/GE Series User’s manual
- Promise FastTrak 376 Controller User’s Manual

Quick Content Table

Function	Content Location	Page
CPU Socket 478	U6	15
DDR DIMM Sockets	DDR DIMM 1、2、3	18
ATX Power Connector	ATX_PWR、ATX_12V	31
IDE Connectors	IDE1/2、RAID IDE1*、SATA1/2*	23
FDC Connector	FDC	26
AGP Slot	AGP	30
PCI Slots	PCI 1、2、3、4、5、6	30
CPU FAN、Chassis FAN、 Auxiliary FAN	CPUFAN、CHASFAN、AUXFAN	16
Front Panel Indicator	SW/LED	21
Speaker Connector	SPEAKER	22
Infrared Connector	IrDA	22
Wake On LAN Header	WOL	26
Front Serial interface Header	COM2	26
Front USB Headers	USB2、USB3	24
Voice Genie / BIOS Mirror & AGP Protection Function Switch*	SW1*	27
Clear CMOS Jumper	JP1	30
Case Open Warning Function	CASE OPEN	24
Sony/Philips Digital Interface Connector	S/PDIF	28
CD-ROM Audio IN Header	CD-IN	28
Front Panel Audio Header	FRONT AUDIO	29
PC99 Color Codec Back Panel	Back Panel Connector	19

* Optional

Configuration

Layout of PX845PE PRO II

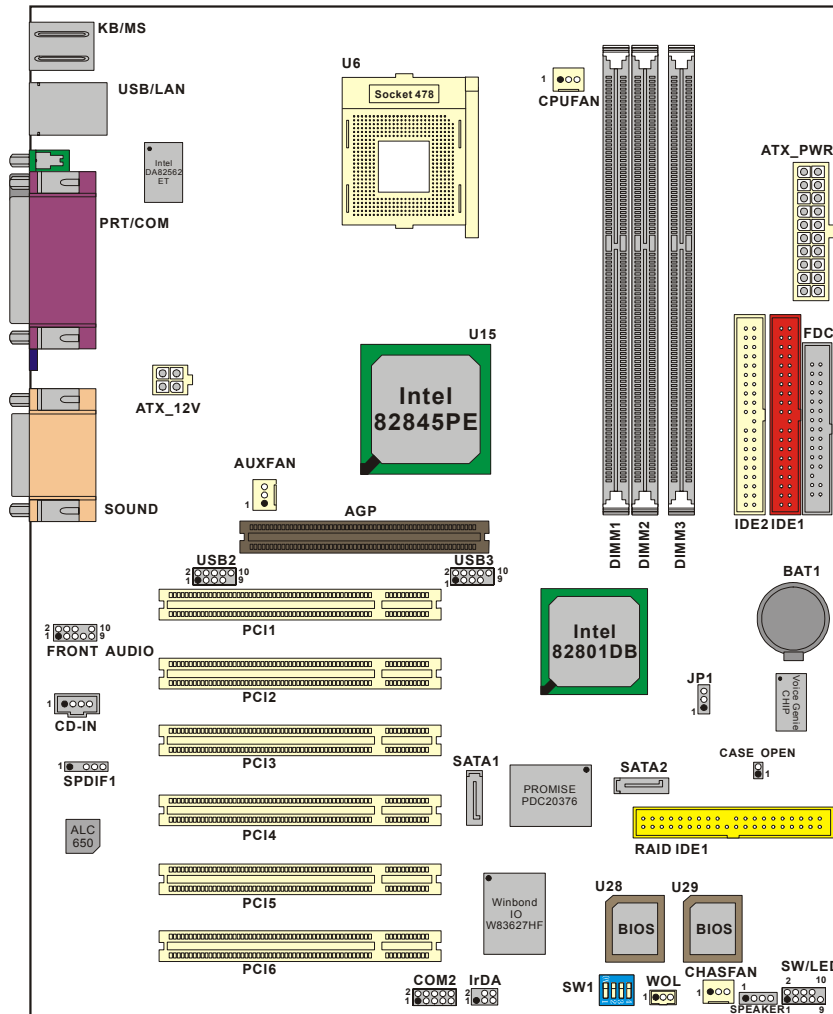

Layout of PX845PE PRO

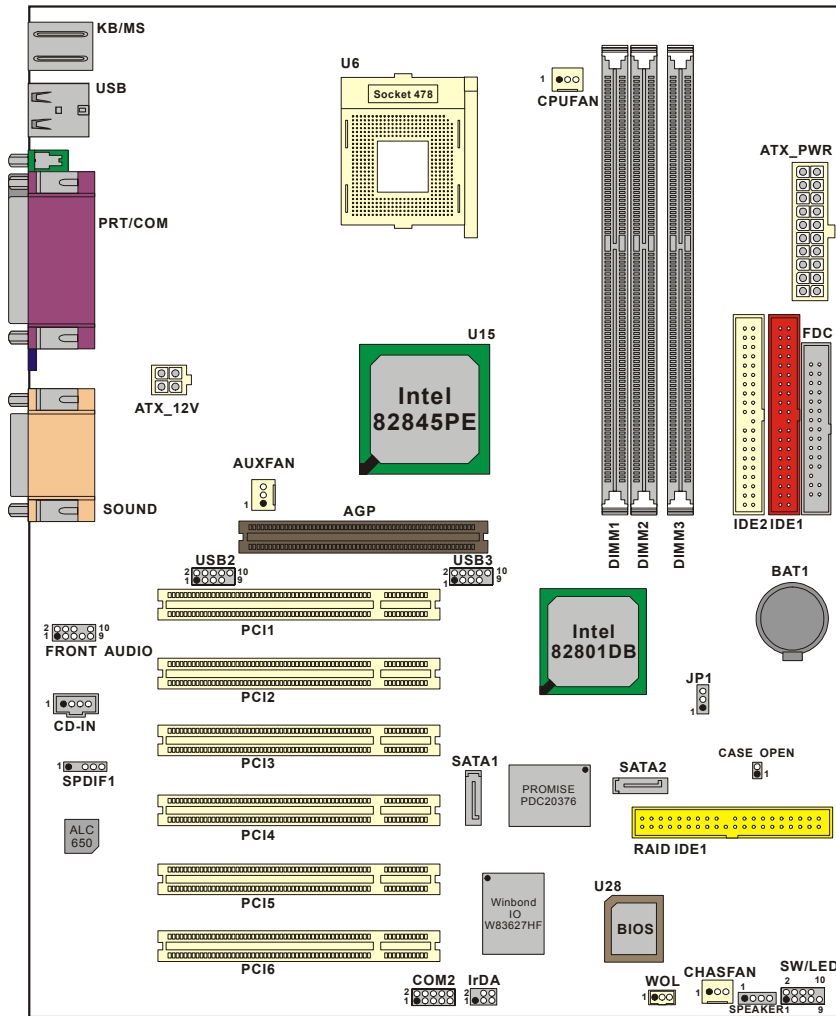

Layout of PX845PE

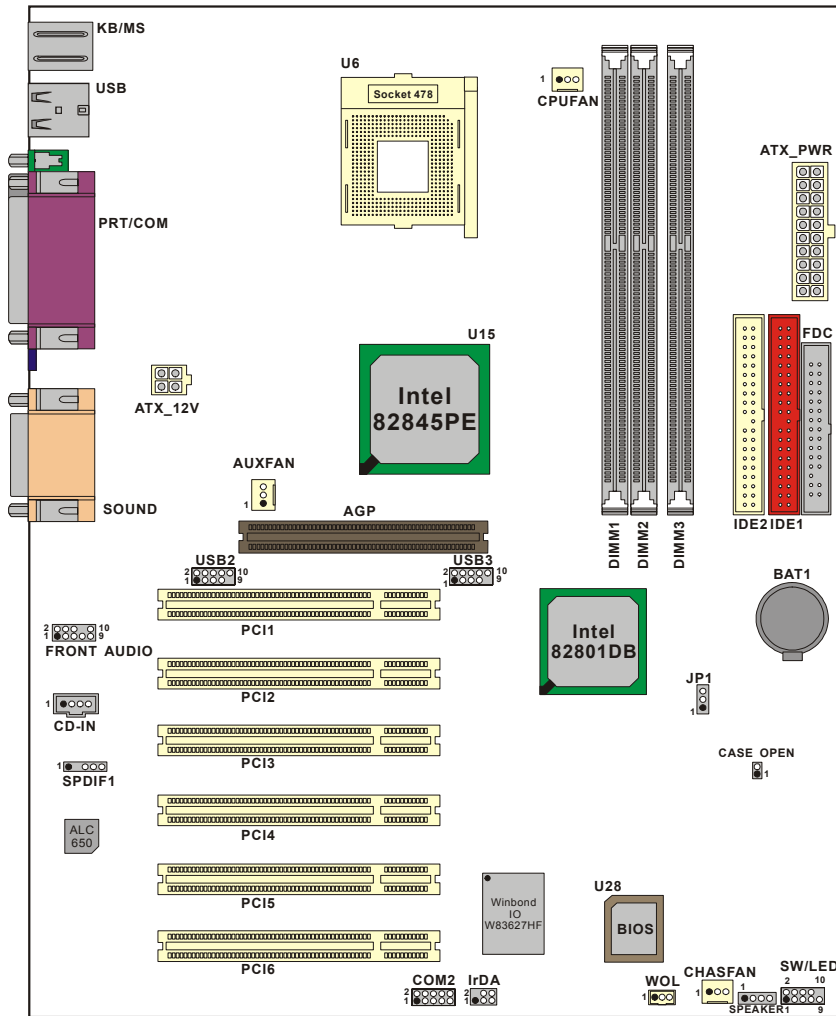

Layout of PX845GE PRO II

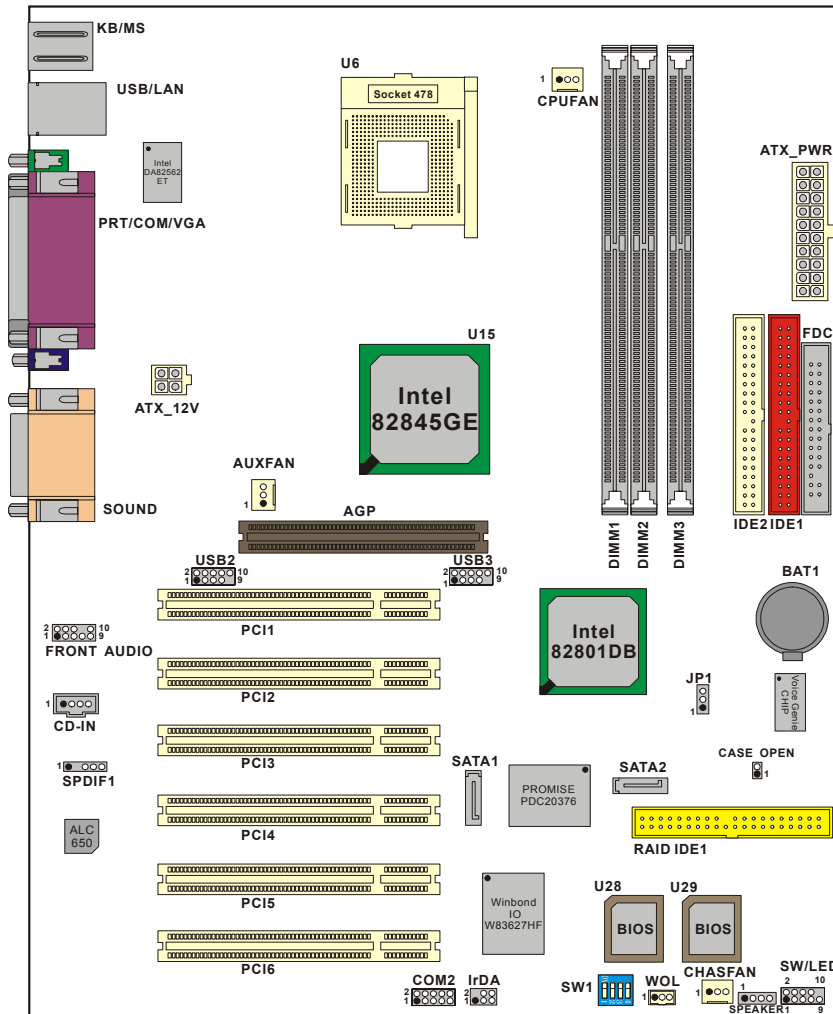

Layout of PX845GE PRO

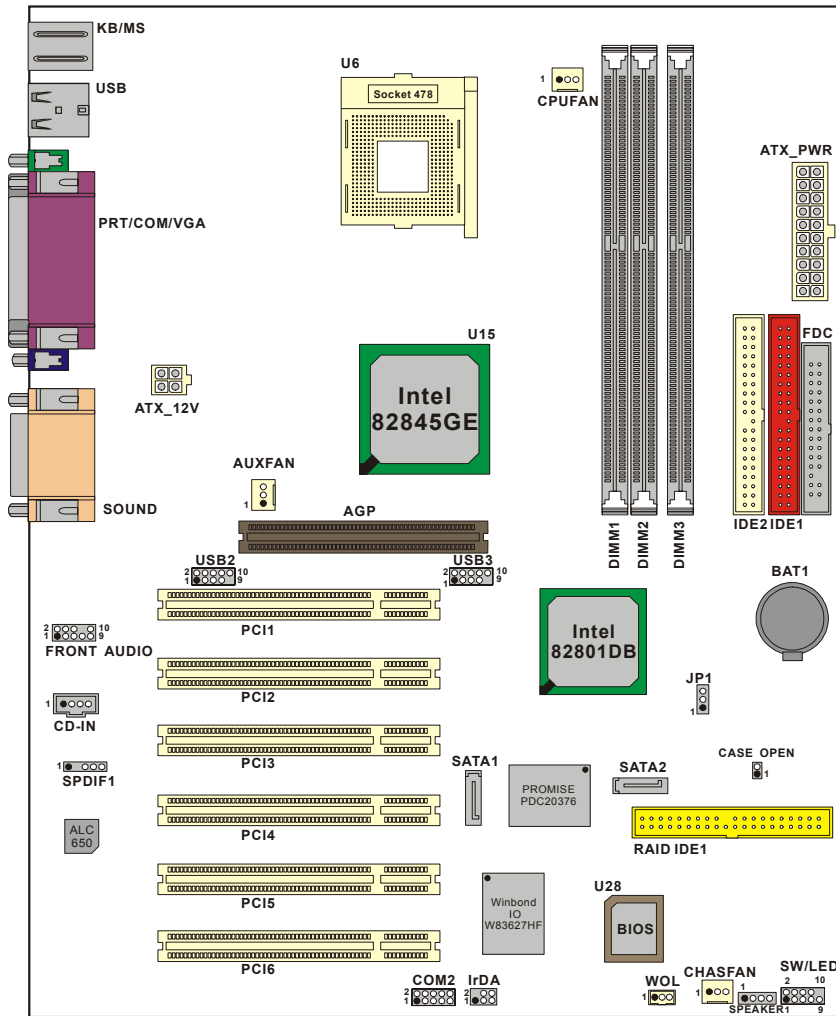

Layout of PX845GE

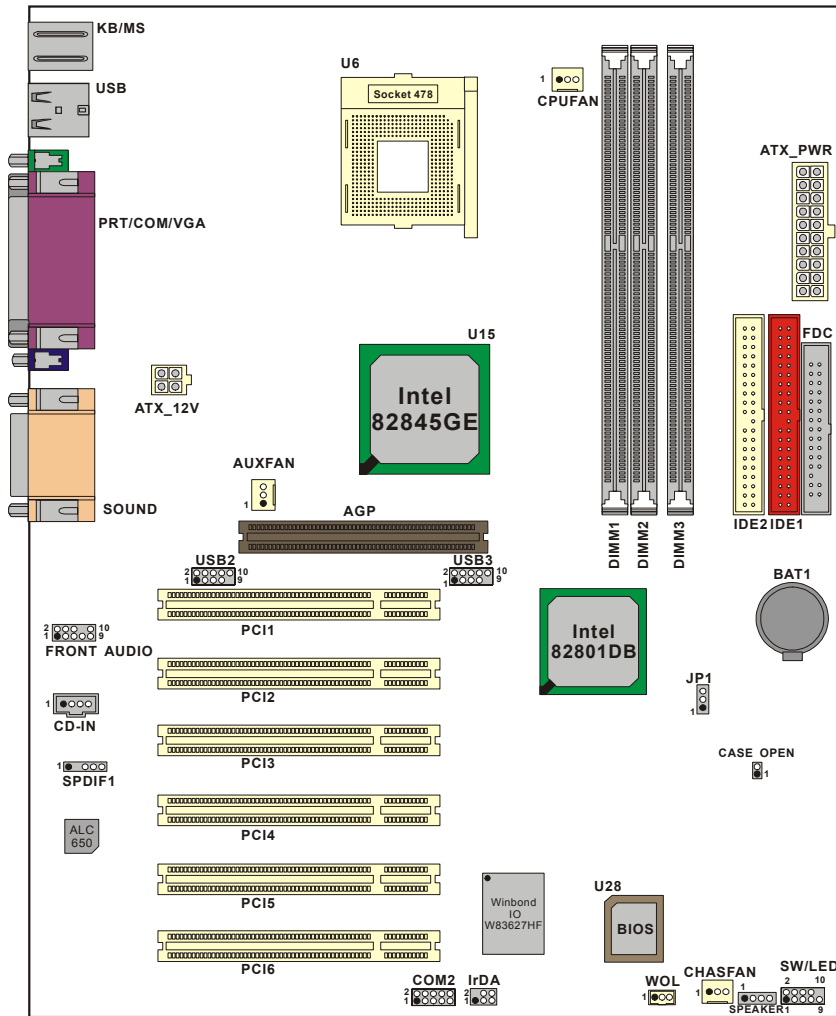

Hardware Installation

This section will assist you in quickly installing your system hardware. Wear a wrist ground strap before handling components. Electrostatic discharge may damage your system components.

Subject:

- ✧ CPU Processor Installation
- ✧ Memory Installation
- ✧ Back Panel Configuration
- ✧ Connector Configuration
- ✧ Header Configuration
- ✧ Jumper Settings
- ✧ Power Supply Attachments

CPU Processor Installation

This mainboard supports Intel® Pentium® 4 processors using a Socket 478.

Before building your system, we suggest you visit the Intel website and review the processor installation procedures. <http://www.intel.com>

CPU Socket 478 Configuration Steps:

1. Locate the CPU socket on your mainboard and nudge the lever away from the socket. Then lift the lever to a 90-degree angle.
2. On the socket, locate the corner that has the pin-1 receptor. This corner will have a cut-corner on the rectangular shaped pattern of pin holes on the socket. Match the dot on the CPU with the pin-1 receptor on the socket and lower the CPU onto the socket. The bottom of the CPU should be flush with the face of the socket.

Pin1 Receptor

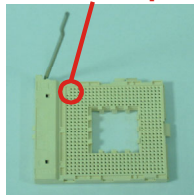

Dot

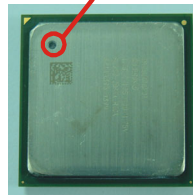

3. Lower the lever until it snaps back into position. This will lock down the CPU.

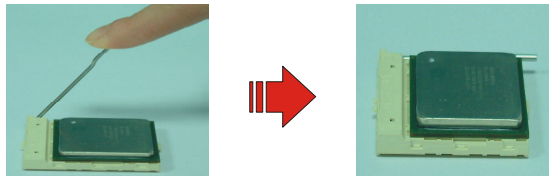

4. Smear thermal grease on top of the CPU. Lower the CPU fan onto the CPU and use the clasps on the fan to attach it to the socket. Finally, extend the power cable from the fan and insert it onto the CPUFAN adapter.

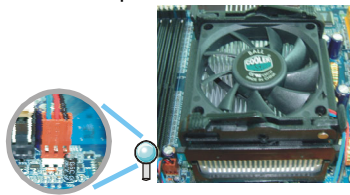

Before starting the system

Please check the installation completely before starting the system.

Verify that the heatsink is properly installed and make sure the CPU fan is working. Overheating can damage the CPU and other sensitive components.

CPU Headers

Three power headers are available for cooling fans, which play an important role in maintaining the ambient temperature in your system.

 We strongly recommend you attach the CPU fan to the CPUFAN Header.

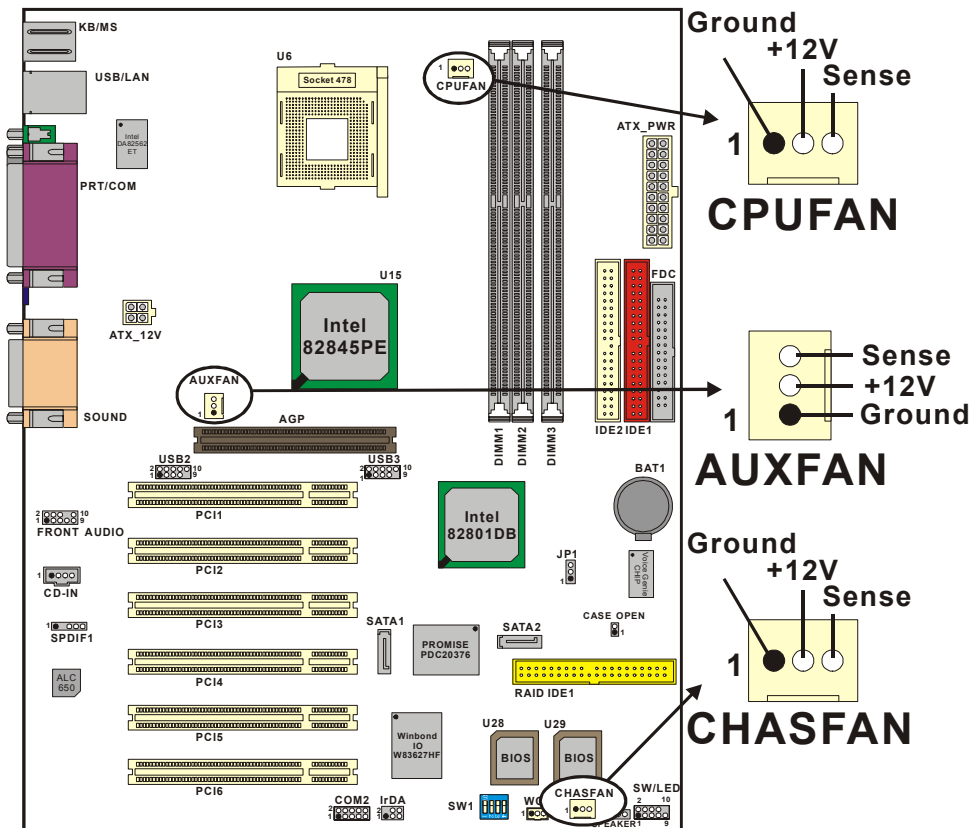

The layout is PX845PE PRO II

Frequency / Voltage Control

This mainboard automatically detects and recognizes the CPU ratio. You can otherwise override these values using the BIOS setup utility.

Configuring the CPU Host Frequency using the BIOS Setup Utility

To access the BIOS Setup Utility, reboot your system. During the reboot process you will be given an opportunity to press the “DEL” key to enter the BIOS Setup Utility.

From the BIOS Setup Utility access the “Advanced BIOS” section and then scroll down to the “Frequency / Voltage Control” field. Adjust the “CPU Clock Ratio”, “CPU Host Frequency” and “DDR:CPU Ratio” according to the formulas below.

CPU Speed = CPU Clock Ratio * CPU Host Frequency

DDR Speed = DDR: CPU Ratio * CPU Host Frequency

For more details, please refer to Frequency / Voltage Control in Chapter-2 BIOS Setup.

Watch Dog Timer

This mainboard comes with a special feature called “Watch Dog Timer” which is used to detect when the system is unable to boot using the manual over-clocking configurations. After you power on the system, BIOS will check the last system POST status. If it was successful, BIOS will enable the “Watch Dog Timer” feature and set the CPU frequency values to the user configured values stored in the BIOS. If unsuccessful the “Watch Dog Timer” will reboot the system.

On most systems you would need to remove the cover of your system and re-jumper the clear CMOS switches on the mainboard when your system encounters over-clocking problems. With the “Watch Dog Timer”, overlocking settings will be automatically cleared and reset.



Before Overclocking

Please make sure your system components are capable of overclocking.

If you are not familiar with the overclocking, we strongly recommend that you to set the clock to the default settings.

Memory Installation

The PX845PE/GE series contains 3 sockets, which use 184--pin DDR SDRAM with a total memory capacity of up to 2GB. You can install unbuffered non-ECC DDR333/ DDR266 (PC2700/ PC2100) SDRAM.

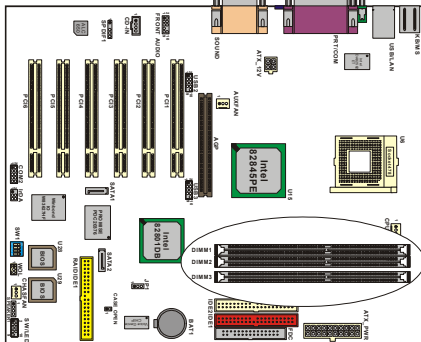

Each DIMM socket is capable of using a memory module of up to 1GB. However, if you use DIMM2 and DIMM3 at the same time, you must use single-sided memory modules and the total memory used by these two sockets cannot exceed 1GB.

The layout is PX845PE PRO II

RAM Module Installation:

1. Match the notch on the bottom of the RAM module with the corresponding pattern in the DIMM slot. This ensures that the module is inserted properly.

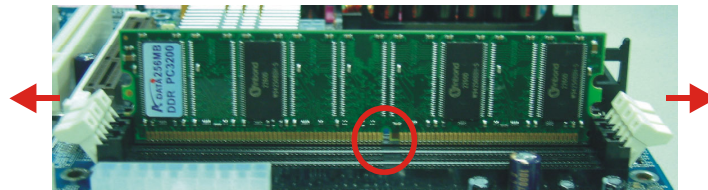

2. Lower the RAM module into the DIMM Slot and press firmly using both thumbs until the module snaps into place.

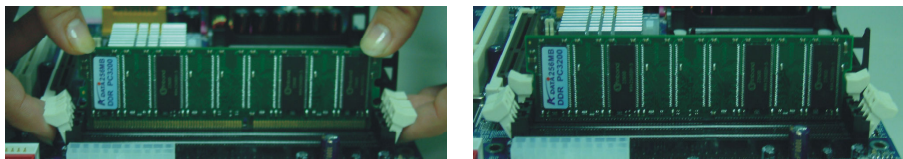

3. Repeat steps 1 & 2 for the remaining RAM modules.

Back Panel Configuration

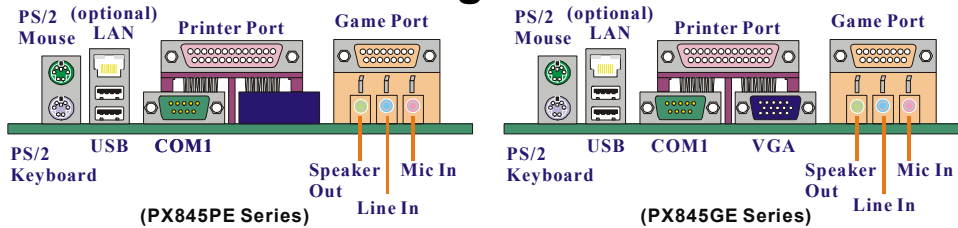

PS/2 Mouse & PS/2 Keyboard Connectors: KB/MS

This mainboard provides a standard PS/2 mouse connector and PS/2 Keyboard connector. The pin assignments are described below:

PS/2 Mouse

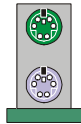

Pin	Assignment	Pin	Assignment
1	Data	4	+5 V (fused)
2	No connect	5	Clock
3	Ground	6	No connect

PS/2 Keyboard

USB & LAN (only for PX845PE/GE PRO II) Conn.: USB/LAN

There are two USB connectors on the back panel. These OHCI (Open Host Controller Interface) Universal Serial connectors are used to attach to USB devices such as: keyboards, mice and other USB devices. You can plug the USB devices directly into this connector. The PX845PE/GE series also provides two USB headers on the board allowing for 4 more USB ports. These attach to USB connectors embedded into the computer case or connected to a USB connector bracket. The PX845PE/GE PRO II also provides a LAN port. You can plug LAN devices directly into this connector.

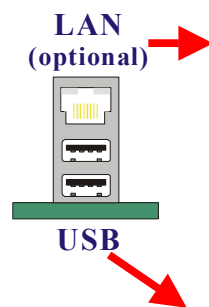

Pin	Assignment	Pin	Assignment
1	TDP	7	NC
2	TDN	8	NC
3	RDP	9	VCC3 SBY
4	NC	10	ACT LED
5	NC	11	VCC3 SBY
6	RDN	12	Speed LED

Pin	Assignment	Pin	Assignment
1/5	+5 V (fused)	3/7	USBP0+/P1+
2/6	USBP0-/P1-	4/8	Ground

Serial and Parallel Interface Ports

The PX845PE series comes equipped with one back panel serial port and one parallel port. The PX845GE series comes equipped with one back panel serial port, one VGA port and one parallel port. These interface ports will be explained below.

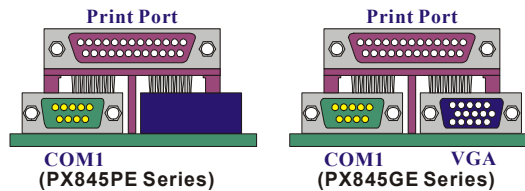

The Serial Interface: COM1

The serial interface port is sometimes referred to as an RS-232 port or an asynchronous communication port. Mice, printers, modems and other peripheral devices can be connected to a serial port.

Parallel Interface Port: PRT

The parallel port on your system has a 25-pin, DB25 connector and is used to interface with parallel printers and other devices using a parallel interface.

Video Graphics Array Conn.: VGA (for PX845GE series)

The PX845GE series has built in video facilities. Your monitor attaches directly to the VGA connector on this mainboard.

Game Port Connector: SOUND

This connector allows you to connect a joystick or game pad for playing computer games. This port can also be used to connect to MIDI devices.

Audio Port Connectors

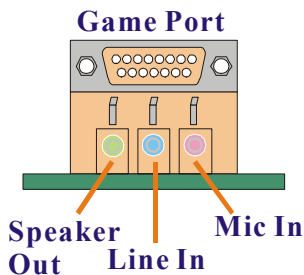

1. **Speaker Out** is used to connect to speakers or headphones. If the Super 5.1 driver is installed the Speaker Out becomes the Front Speaker.
2. **Line In** can be connected to an external CD player, Tape player or other audio devices for audio input. If the Super 5.1 driver is installed Line In becomes the Rear Speaker.
3. **Mic In** is used to connect to a microphone. If the Super 5.1 driver is installed the Mic In becomes the Subwoofer/ Center out.

 This mainboard supports Super 5.1 Channel Audio effects which turns your standard Speaker Out, Lin In, Mic In audio connectors into a 6 channel audio system. See Chapter 3. for more information.

Connector Configuration

Front Panel Indicator: SW/LED

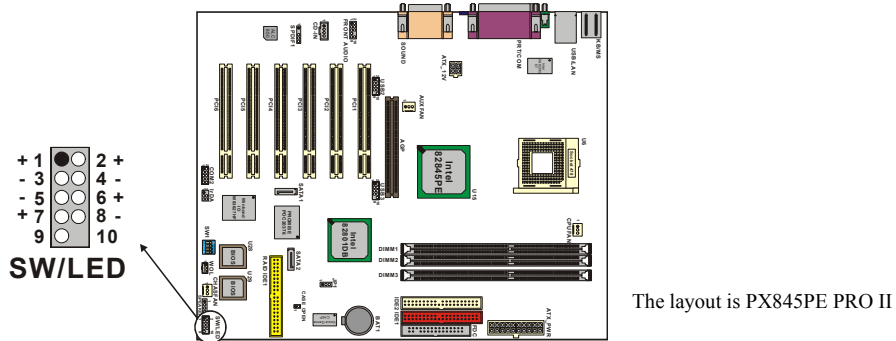

Pin	Assignment	Function	Pin	Assignment	Function
1	HD LED (+)	Hard Drive LED	2	Power LED (+)	POWER
3	HD LED (-)		4	Power LED (-)	LED
5	Reset Control (-)	Reset Button	6	Power Button(+)	Power-on Button
7	Reset Control(+)		8	Power Button(-)	
9	NC	NC	10	NC	NC

HD LED (Hard Drive LED Connector)

This connector can be attached to an LED on the front panel of a computer case. The LED will flicker during disk activity. This disk activity only applies to those IDE drives directly attached to the system board.

RST (Reset Button)

This connector can be attached to a momentary SPST switch. This switch is normally left open. When closed it will cause the mainboard to reset and run the POST (Power On Self Test).

PWR-LED (Power LED Connector)

This connector can be attached to an LED on the front panel of a computer case. The LED will illuminate while the computer is powered on.

PWR ON (Power Button)

This connector can be attached to a front panel power switch. The switch must pull the Power Button pin to ground for at least 50 ms to signal the power supply to switch on or off (the time required is due to internal debounce circuitry on the system board). At least two seconds must pass before the power supply will recognize another on/off signal.

SPEAKER (Speaker Connector)

An off-board speaker can be connected to this connector. This speaker (onboard or off-board) provides error beep code information during the Power On Self-Test when the computer cannot access the video interface.

 The speaker cannot be connected to the audio subsystem and can not receive output from the audio subsystem.

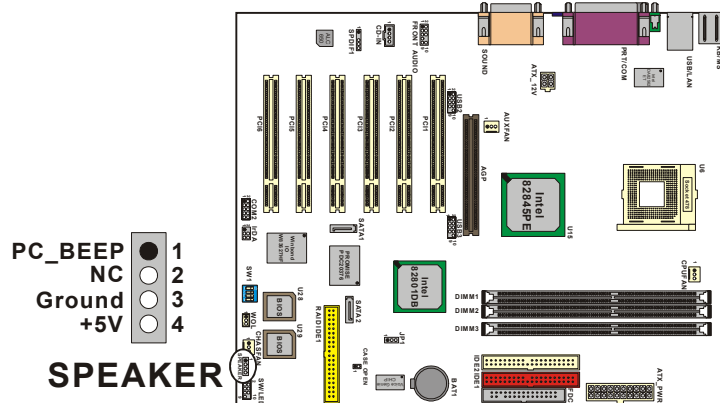

The layout is PX845PE PRO II

IrDA (Infrared Connector)

This IrDA connector can be configured to support wireless infrared and is used to attach to an infrared sensing device. After the IrDA interface is configured, you can use this connector for connectionless data transfer to and from portable devices such as laptops and PDAs.

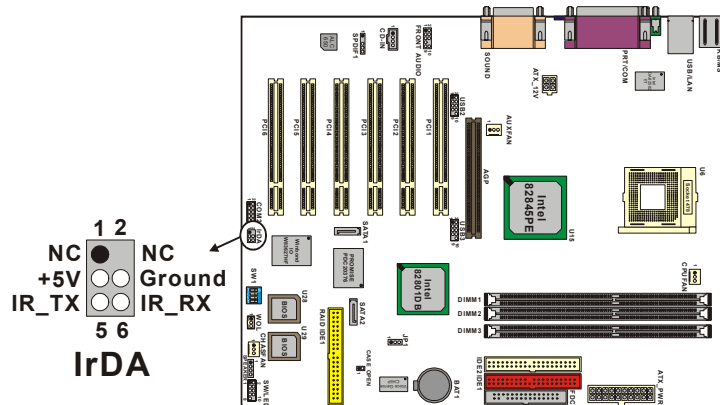

The layout is PX845PE PRO II

Floppy Disk Connector: FDC

This mainboard provides a standard floppy disk connector (FDC) that supports 360K, 720K, 1.2M, 1.44M and 2.88M floppy diskettes. This connector supports the floppy drive ribbon cables provided in the packaging.

Hard Disk Connectors: IDE1-2/ RAID IDE1/ SATA1-2

This mainboard has a 32-bit Enhanced PCI IDE Controller that supports PIO Mode 0~4, Bus Master, Ultra DMA / 33, Ultra DMA / 66, and Ultra DMA / 100. It has two HDD connectors, IDE1 (primary) and IDE2 (secondary). And the PX845PE/GE PRO & PX845PE/GE PRO II includes a PROMISE PDC20376 chip that supports one RAID IDE connector and two SATA connectors. The RAID IDE connector supports Ultra 133 and the SATA connectors support Serial ATA 150.

IDE1 (Primary IDE Connector)

You can connect up to two hard drives to IDE1. If you attach two drives, you must use a ribbon cable with three connectors. You must also configure one drive as the master and one drive as the slave, using the jumpers located on each drive.

IDE2 (Secondary IDE Connector)

The IDE2 controller can also support a Master and a Slave drive. The configuration is similar to IDE1. The second drive on this controller must be set to slave mode.

RAID IDE1 (only for PRO & PRO II version)

The RAID IDE1 support Ultra ATA 133. The connector support RAID specification 0 or 1 can connect a Master drive only.

SATA1/SATA2 (only for PRO & PRO II version)

The SATA connectors support Serial ATA 150. The connectors only can connect one device each.

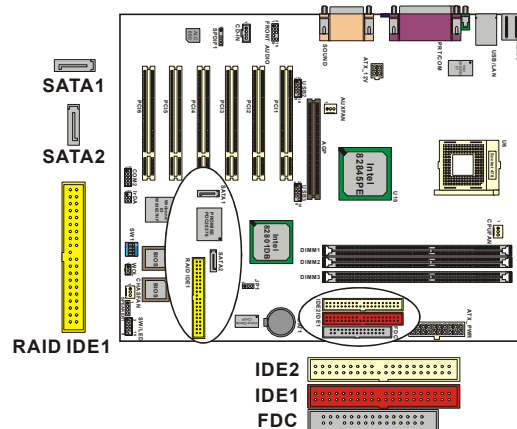

The layout is PX845PE PRO II

Headers & Jumpers

Front USB Headers: USB2 / USB3

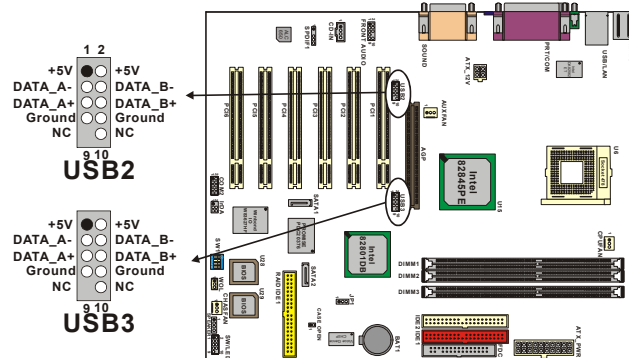

The layout is PX845PE PRO II

USB bracket (optional)

You can connect the USB bracket to the USB2 and USB3 Headers.

* If you are using USB 2.0 devices, you will need to install the USB 2.0 driver from Microsoft® website.

Case Open Warning Jumper: CASE OPEN

This connector is used to notify the user when the computer case has been previously opened. To configure this functionality, your computer case must be equipped with a “case open” cable which you need to attach to the CASE OPEN connector. Also, you must enable CASE OPEN warning functionality in the BIOS setup utility. When your computer case is opened, your system will display alert messages upon boot up. Note that your computer case must be equipped with a “case open” cable.

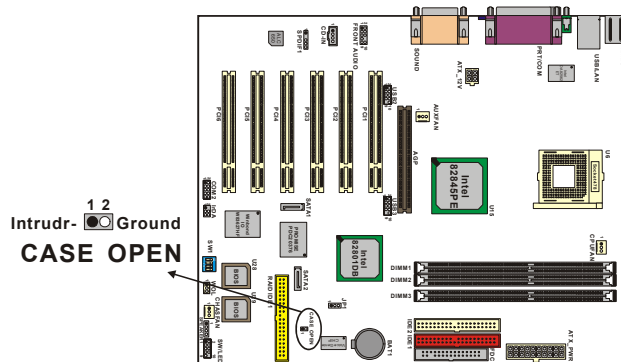

The layout is PX845PE PRO II

Voice Genie /BIOS Mirror and AGP Protection Function: SW1 (only for PX845PE/GE PRO II)

This switch is used to configure the Voice Genie, BIOS Mirror and AGP Protection functions. With SW1-1 and SW1-2, you can select the appropriate language for audio diagnostics. With the SW1-3 switch, you can enable or disable AGP Protection. AGP protection is used to ensure that only 1.5V AGP cards are used in the AGP slot. With the SW1-4 switch, you can begin using the alternate or mirror BIOS by switching this switch to “rescue”. This is used when the primary BIOS had been infected with a virus or damaged during a flash update.

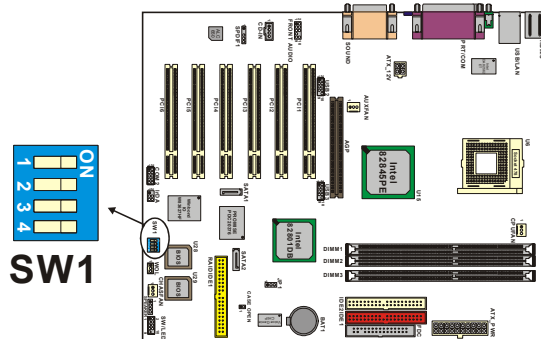

The layout is PX845PE PRO II

Voice Genie

Voice Genie	SW1-1	SW1-2
English	ON	ON
Chinese	ON	OFF
Japanese	OFF	ON
German	OFF	OFF

AGP Protection

AGP Protection	SW1-3
Enable(default)	ON
Disable	OFF

BIOS Mirror

BIOS Mirror	SW1-4
Enable(default)	ON (U28)
Disable	OFF (U29)

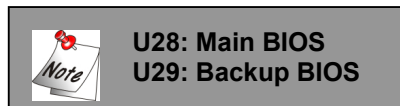

Wake On LAN Header: WOL

This mainboard supports the Wake On LAN function. To use this function, a network card with a chipset that supports this feature is required. A WOL network card will have a cable that you need to attach to this connector.

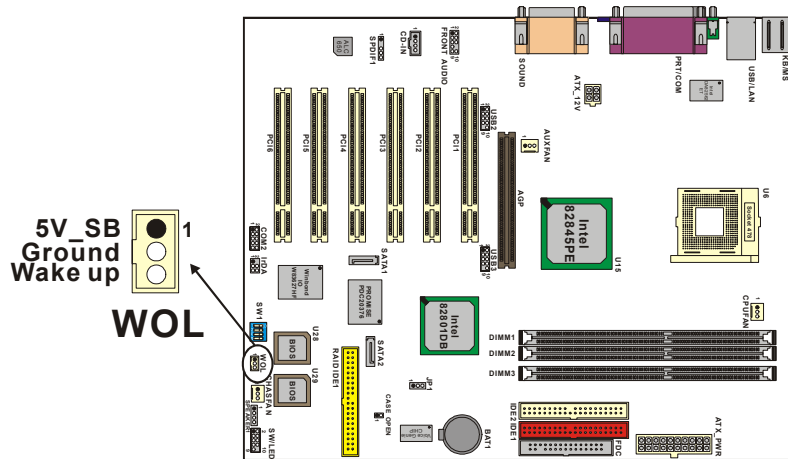

The layout is PX845PE PRO II

Front Serial interface Header: COM2

This mainboard supports a front serial header. Connect with a bracket (optional) then you can use other serial interface device.

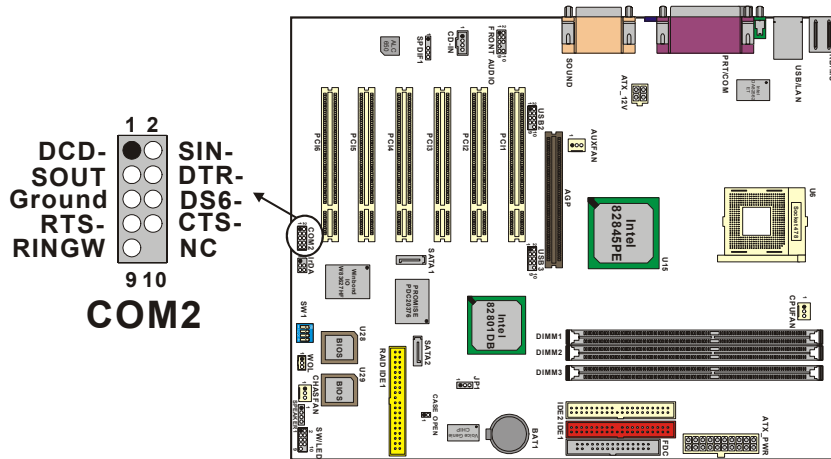

The layout is PX845PE PRO II

Clear CMOS Jumper: JP1

The “Clear CMOS” jumper is used when you cannot boot your system due to some CMOS configuration such as a password that is forgotten. This jumper allows you to reset the CMOS configurations, and then reconfigure.

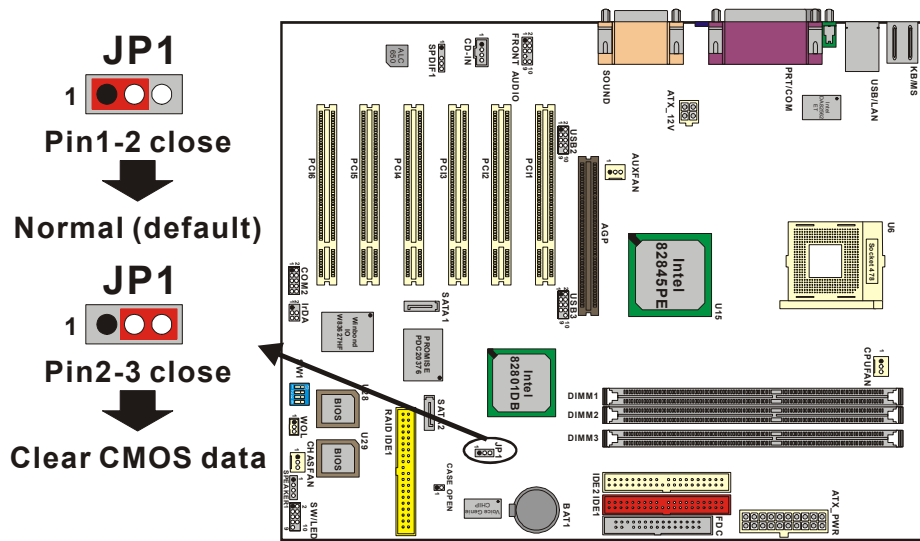

The layout is PX845PE PRO II

 The following procedures are for resetting the BIOS password. It is important to follow these instructions closely.

1. Turn off your system and disconnect the AC power cable.
2. Set JP1 to OFF (2-3 Closed).
3. Wait several seconds.
4. Set JP1 to ON (1-2 closed).
5. Connect the AC power cable and turn on your system.
6. Reset your desired password or clear CMOS data.

Audio Connectors

This mainboard provides three connectors as part of its audio Subsystem.

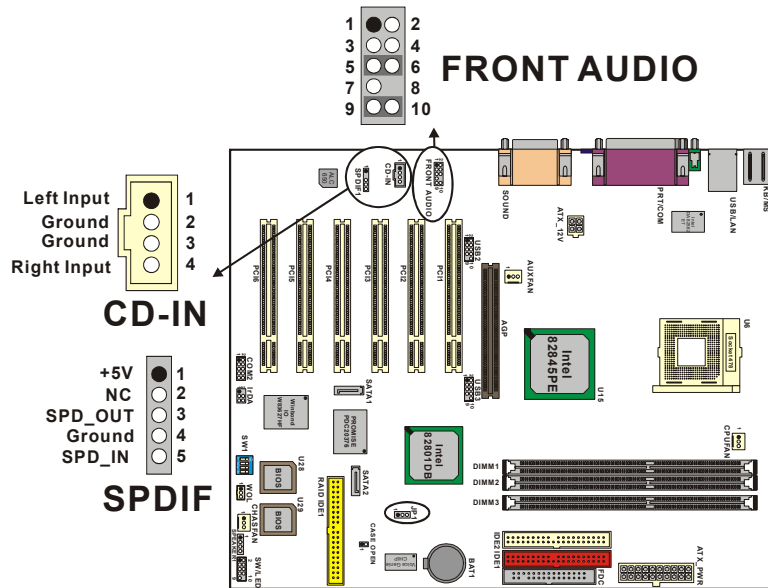

The layout is PX845PE PRO II

CD-ROM Audio-In Header: CD-IN

This header is used to connect to a CD-ROM / DVD audio cable.

S/PDIF (Sony/Philips Digital Interface) Connector: SPDIF

S/PDIF (Sony/Philips Digital Interface) is a recent audio transfer file format, which provides high quality audio using optical fiber and digital signals. This mainboard is capable of delivering audio output and receiving audio input through the SPDIF header. One way you would use this header is by using an SPDIF bracket attached to your computer. This bracket will have a cable that you can attach to the SPDIF header. This bracket will also have an RCA connector, similar to that used with most consumer audio products. Using the RCA connector, the data can then be output to and input from an S/PDIF device. On the SPDIF header, SPD-OUT is used for output and SPD-IN is used for input. The devices that are receiving and sending information from this header must be S/PDIF compliant for optimal effect. Note that the SPDIF bracket is optional in the packaging that comes with this mainboard.

Front Panel Audio Header: FRONT AUDIO

If your computer case has been designed with embedded audio equipment. You can attach these components to the FRONT_AUDIO panel of the mainboard. First remove the jumper caps covering the FRONT_AUDIO pins. Use pins 1, 3 to connect to the case microphone. Use pins 9,5 to connect to the earphone. If you do not intend to use the FRONT_AUDIO panel, do not remove the jumper caps.

Pin No.	Assignment	Pin No.	Assignment
1	FP_MIC	2	Ground
3	FP_VREF	4	+5V
5	SPOUT_R (From IC)	6	SPOUT_R (To Connector)
7	NC	8	NC
9	SPOUT_L (From IC)	10	SPOUT_L (To Connector)



If the jumper caps are in place, jumper cap 1 is on pin 5, pin 6 and jumper cap 2 is on pin 9, pin 10.

SPDIF & Front Audio dual-function bracket (only for PRO II version)

You can connect the bracket to the SPDIF and FRONT AUDIO Headers.

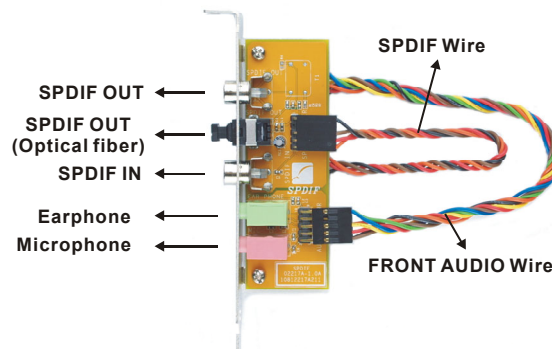

Slots

The slots in this mainboard are designed for expansion cards used to complement and enhance the functionality of the mainboard.

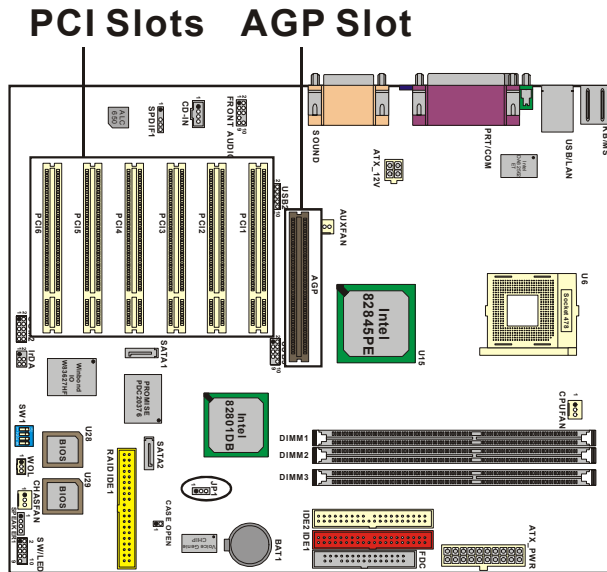

The layout is PX845PE PRO II

AGP (Accelerated Graphics Port) Slot

This mainboard is equipped with an Accelerated Graphics Port (AGP) (1.5v only) to support video cards. And the PX845PE/GE Series also comes with AGP protection which ensures that you only install 1.5V AGP cards.

PCI (Peripheral Component Interconnect) Slots

This mainboard is equipped with 6 standard PCI slots. PCI stands for Peripheral Component Interconnect and is a bus standard for expansion cards, which has, for the most part, supplanted the older ISA bus standard. This PCI slot is designated as 32 bit.

*Six 32-bit PCI bus slots (5 master slots are for PX845PE/GE PRO & PRO II)

*Six 32-bit PCI bus slots (6 master slots are for PX845PE/GE)

Power Supply Attachments

ATX Power Connector: ATX_PWR & ATX_12V

This mainboard requires two ATX power connections; a 20-pin connector and a 4-pin connector, your power supply must have both connectors. Attach the 4-pin connector first, then attach the 20-pin connector. Make sure the connectors are secure before applying power.

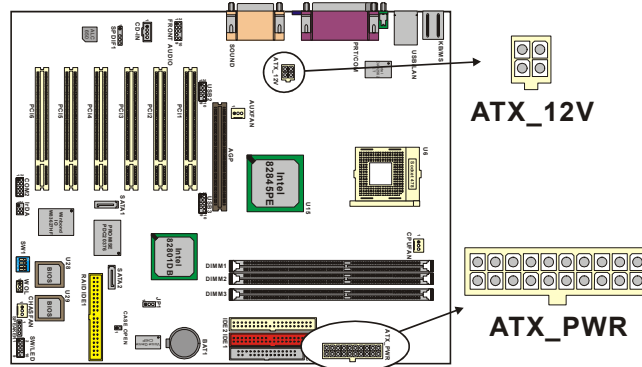

The layout is PX845PE PRO II

ATX_12V

PIN	Assignment	PIN	Assignment
1	Ground	3	+12V
2	Ground	4	+12V

ATX_PWR

PIN	Assignment	PIN	Assignment
1	+3.3V	11	+3.3V
2	+3.3V	12	-12V
3	Ground	13	Ground
4	+5V	14	PS_ON
5	Ground	15	Ground
6	+5V	16	Ground
7	Ground	17	Ground
8	PW_OK	18	-5V
9	5V_SB	19	+5V
10	+12V	20	+5V

Chapter 2. BIOS Setup

Introduction

This section describes PHOENIX-AWARD™ BIOS Setup program which resides in the ROM BIOS firmware. The Setup program allows users to modify the basic system configuration. The configuration information is then saved to CMOS RAM where the data is sustained by battery after power-down.

The BIOS provides critical low-level support for standard devices such as disk drives, serial ports and parallel ports. As well, the BIOS controls the first stage of the boot process, loading and executing the operating system.

The PHOENIX-AWARD™ BIOS installed in your computer system's ROM is a custom version of an industry standard BIOS. This means that it supports the BIOS of Intel® based processors.

This version of the PHOENIX-AWARD™ BIOS includes additional features such as virus and password protection as well as special configurations for fine-tuning the system chipset. The defaults for the BIOS values contained in this document may vary slightly with the version installed in your system.

Plug and Play Support

This PHOENIX-AWARD™ BIOS supports the Plug and Play Version 1.0A specification as well as ESCD (Extended System Configuration Data) write.

EPA Green PC Support

This PHOENIX-AWARD™ BIOS supports Version 1.03 of the EPA Green PC specification.

APM Support

This PHOENIX-AWARD™ BIOS supports Version 1.1 & 1.2 of the Advanced Power Management (APM) specification. These features include system sleep and suspend modes in addition to hard disk and monitor sleep modes. Power management features are implemented using the System Management Interrupt (SMI).

PCI Bus Support

This PHOENIX-AWARD™ BIOS also supports Version 2.1 of the Intel PCI (Peripheral Component Interconnect) local bus specification.

DRAM Support

DDR (Double Data Rate) SDRAM (Synchronous DRAM) is supported.

Supported CPUs

This PHOENIX-AWARD™ BIOS supports the Intel® Pentium® 4 CPUs.

Key Function

In general, you can use the arrow keys to highlight items, press <Enter> to select, use the <PgUp> and <PgDn> keys to change entries, press <F1> for help and press <Esc> to quit. The following table provides more detail about how to navigate within the BIOS Setup program.

Keystroke	Function
Up arrow	Move to previous item
Down arrow	Move to next item
Left arrow	Move to the item on the left (menu bar)
Right arrow	Move to the item on the right (menu bar)
Esc	Main Menu: Quit without saving changes Submenus: Exit Current page to the next higher level menu
Move Enter	Move to the item you desired
PgUp key	Increase the numeric value or make changes
PgDn key	Decrease the numeric value or make changes
+ Key	Increase the numeric value or make changes
- Key	Decrease the numeric value or make changes
Esc key	Main Menu – Quit and not save changes into CMOS Status Page Setup Menu and Option Page Setup Menu – Exit Current page and return to Main Menu
F1 key	General help on Setup navigation keys
F5 key	Load previous values from CMOS
F6 key	Load the fail-safe defaults from BIOS default table
F7 key	Load the optimized defaults
F10 key	Save all the CMOS changes and exit

Main Menu

When you enter the PHOENIX-AWARD™ BIOS Utility, the Main Menu will appear on the screen. The Main menu allows you to select from several configuration options. Use the left/right arrow keys to select a particular configuration screen from the top menu bar or use the down arrow key to access and configure the information below.

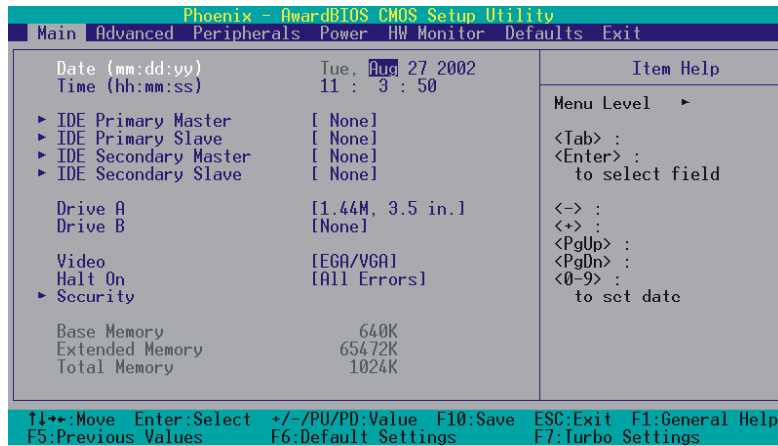

Main Menu Setup Configuration Options

Item	Options	Description
Date	mm dd yyyy	Set the system date. Note that the 'Day' automatically changes when you set the date.
Time	Hh: mm: ss	Set the current time of the system.
IDE Primary Master	Options contained in sub menu.	Press <Enter> to enter the sub menu.
IDE Primary Slave	Options contained in sub menu.	Press <Enter> to enter the sub menu.
IDE Secondary Master	Options contained in sub menu.	Press <Enter> to enter the sub menu.
IDE Secondary Slave	Options contained in sub menu.	Press <Enter> to enter the sub menu.
Drive A Drive B	360K, 5.25 in 1.2M, 5.25 in 720K, 3.5 in 1.44M, 3.5in 2.88M, 3.5 in None	Select the type of floppy disk drive installed in your system.
Video	EGA/VGA CGA 40 CGA 80 MONO	Select the default video device.
Halt On	All Errors No Errors All, but Keyboard All, but Diskette All, but Disk/ Key	Select the situation in which you want the BIOS to stop the POST process and notify you.
Security	Options contained in sub menu.	Press <Enter> to enter the sub menu.
Base Memory	N/A	Displays the amount of conventional memory detected during boot up.
Extended Memory	N/A	Displays the amount of extended memory detected during boot up.
Total Memory	N/A	Displays the total memory available in the system.

Advanced BIOS Features

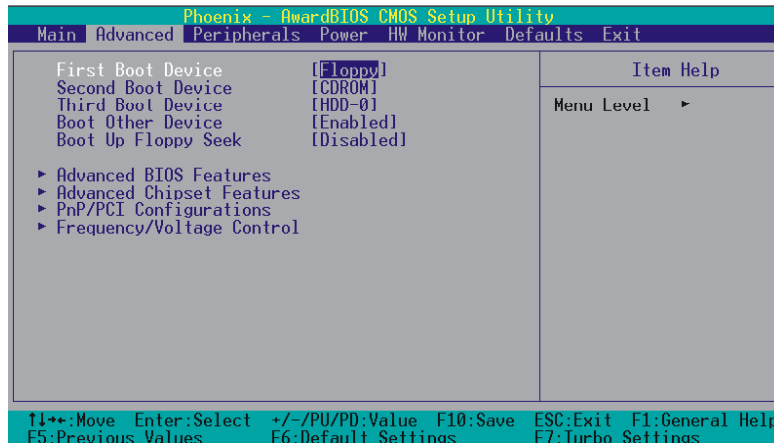

First /Second/Third/ Boot Device

Select the order in which devices will be searched in order to find a boot device.

Options: Floppy \ LS120 \ HDD-0 \ SCSI \ CDROM \ HDD-1 \ HDD-2 \ HDD-3 \ ZIP100 \ SB-FDD \ USB-ZIP \ USB-CDROM \ USB-HDD \ LAN \ Disabled

Boot Other Device

The setting allows the system to try to boot from other devices if the system fails to boot from the 1st/ 2nd/ 3rd boot devices. Options: Enabled (default) \ Disabled

Boot Up Floppy Seek

When Enabled, the BIOS tests (seeks) floppy drives to determine whether they have 40 or 80 tracks. Only 360-KB floppy drives have 40 tracks. Drives with 720KB, 1.2MB, and 1.44MB capacity all have 80 tracks. Because very few modern PCs have 40-track floppy drives, we recommend that you set this field to "Disabled".

Options: Enabled \ Disabled (default)

Advanced BIOS Features

Virus Warning

This item allows you to choose the VIRUS warning feature for IDE Hard Disk boot sector protection. If this function is enabled and someone attempts to write data into this area, BIOS will display a warning message on the screen and sound an audio alarm (beep).

Options: Disabled (default) Virus protection is disabled.
 Enabled Virus protection is activated.

CPU L1 & L2 Cache

Make CPU internal cache active or inactive. System performance may degrade if you disable this item. Options: Enabled (default) \ Disable.

Quick Power On Self Test

Allow the system to skip certain tests while booting. This will speed up the boot process. Options: Enabled (default) \ Disabled.

Swap Floppy Drive

If the system has two floppy drives, choose "Enabled" to assign physical drive B to logical drive A and vice-versa. Options: Disabled (default) \ Enabled.

Boot Up NumLock Status

Selects the power on state for NumLock.
Options: On (default) Numpad keys are number keys.
Off Numpad keys are arrow keys.

Typematic Rate Setting

When "Enabled", the "typematic rate" and "typematic delay" can be configured. Typematic Rate determines the keystroke repeat rate used by the keyboard controller..
Options: Disabled (default) \ Enabled

Typematic Rate (Chars/Sec)

The rate at which a character repeats when you hold down a key.
Options: 6 (default) \ 8 \ 10 \ 12 \ 15 \ 20 \ 24 \ 30

Typematic Delay (Msec)

The delay before keystrokes begin to repeat. Options: 250 (default) \ 500 \ 750 \ 1000

APIC Mode

By enabling this option, "MPS version control for OS" can be configured.
Options: Disabled \ Enabled (default)

MPS Version Control For OS

The 1.1 version is the older version that supports 8 more IRQs in the Windows NT environment. Choose the new 1.4 version for Windows 2000 and Windows XP.
Options: 1.4 (default) \ 1.1

OS Select For DRAM > 64MB

Select "OS2" only if you are running the OS/2 operating system with greater than 64MB of RAM. Options: Non-OS2 (default) \ OS2

HDD S.M.A.R.T. Capability

Self Monitoring Analysis and Reporting Technology is a technology that enables a PC to attempt to predict the possible failure of storage drives. Options: Disabled (default) · Enabled

Small LOGO (EPA) Show

This item allows you to show or hide the small LOGO EPA.
Options: Disabled (default) · Enabled

Advanced Chipset Features

DRAM Timing Selectable

This item determines DRAM clock/ timing using SPD or manual configuration.
Make sure your memory module has SPD (Serial Presence Data), if you want to select the <By SPD> option. Options: Manual, By SPD (default)

CAS Latency Time

This item determines CAS Latency. When synchronous DRAM is installed, the number of clock cycles of CAS latency depends on the DRAM timing. Do not reset this field from the default value specified by the system designer. Options: 1.5 · 2 · 2.5 · 3 and By SPD (default)

Active to Precharge Delay

This item allows you to select DRAM Active to Precharge Delay.
Options: 7 · 6 · 5 and By SPD (default)

DRAM RAS# to CAS# Delay

This item allows you to select a delay time between the CAS and RAS strobe signals. It only applies when DRAM is written to, read from, or refreshed.
Options: 3 · 2 and default is by SPD

DRAM RAS# Precharge

This item allows you to select the DRAM RAS# precharge time. The ROW address strobe must precharge again before DRAM is refreshed. An inadequate configuration may result in incomplete data. Options: 3 · 2 and By SPD (default)

Refresh Mode Select

Select the refresh mode.
Options: 15.6 us · 7.8 us · 64 us · Auto (default)

System BIOS Cacheable

When enabled, accesses to system BIOS ROM addressed at F0000H-FFFFFH are cached, provided that the cache controller is enabled. Options: Enabled (default), Disabled

Video BIOS Cacheable

Select "Enabled" to allow caching of the video BIOS which may improve performance. If any other program writes to this memory area, a system error may result.

Options: Enabled, Disabled (default)

Memory Hole at 15M-16M

When enabled, you can reserve an area of system memory for ISA adapter ROM. When this area is reserved, it cannot be cached. Refer to the user documentation of the peripheral you are installing for more information. Options: Disabled (default) ∙ Enabled

Delayed Transaction

The chipset has an embedded 32-bit posted write buffer to support delay transaction cycles. Select "Enabled" to support compliance with PCI specifications.

Options: Disabled, Enabled (default)

Delay Prior to Thermal

Select the delay time before thermal activation from high temperatures.

Options: 4 Min ∙ 8 Min ∙ 16 Min (default) ∙ 32 Min

AGP Aperture Size (MB)

Select the size of the AGP (Accelerated Graphics Port) aperture. The aperture is a portion of the PCI memory address range dedicated for graphics memory address space. Host cycles that hit the aperture range are forwarded to the AGP without any translation.

Options: 4 ∙ 8 ∙ 16 ∙ 32 ∙ 64 (default) ∙ 128 ∙ 256

**** On-Chip VGA Setting ** (only for PX845GE series)**

On-Chip VGA

This item allows you to enable or disable the on-chip VGA.

Options: Disabled ∙ Enabled (default)

On-Chip Frame Buffer Size

Choose the size of the on-chip frame buffer. Options: 1MB ∙ 8MB (default)

PnP/PCI Configurations

Reset Configuration Data

Select "Enabled" to reset the Extended System Configuration Data (ESCD) if you have installed a new add-on card and the system reconfiguration has caused such a serious conflict that the OS cannot boot. Options: Disabled (default) ∙ Enabled

Resources Controlled By

BIOS can automatically configure all the boot and Plug and Play compatible devices. If you choose Auto, you will not be able to manually assign IRQ DMA and memory base address fields, since BIOS automatically assigns them. Options: Auto <ESCD> (default) · Manual

IRQ Resources

When resources are controlled manually, you can assign each system interrupt a type, depending on the type of device using the interrupt. This is only configurable when “Resources Controlled By” is set to “Manual”.

IRQ-3	assigned to: PCI device
IRQ-4	assigned to: PCI device
IRQ-5	assigned to: PCI device
IRQ-7	assigned to: PCI device
IRQ-9	assigned to: PCI device
IRQ-10	assigned to: PCI device
IRQ-11	assigned to: PCI device
IRQ-12	assigned to: PCI device
IRQ-14	assigned to: PCI device
IRQ-15	assigned to: PCI device

PCI / VGA Palette Snoop

Some graphic controllers that are not VGA compatible take the output from a VGA controller and map it to their display as a way to provide boot information and VGA compatibility. Options: Disabled (default) · Enabled

PCI Latency Timer (CLK)

This item allows you to set up the PCI Latency Time (0-255). If you select the “32” it will optimize PCI speeds. Options: 0-255 · 32 (default)

PCI SLOT1- 6

This item allows you to select an IRQ address for your PCI slot 1-6.
Options: Auto (default) · 3 · 4 · 5 · 7 · 9 · 10 · 11 · 12 · 14 · 15

Frequency/Voltage Control

Default CPU Voltage (Volt)

This item displays the CPU Voltage information which is detected by the system.

CPU Voltage (Volt)

This item allows you to adjust your CPU core voltage. Options range from 1.100V~1.850V

CPU Clock Ratio

Before you configure this option, please make sure that your CPU ratio can be adjusted. This item displays the CPU ratio information detected by the system.
Options: 8x - 50X

Spread Spectrum

The Spread Spectrum function can reduce the EMI (Electromagnetic Interference) generated.
Options: Enabled (default) - Disabled

CPU Host Frequency (MHz)

This item displays the CPU Host Clock. You can set it from 100 to 248. The default depends on your CPU frequency. If you over-clock the following 2 items can be adjusted.
Default: By CPU speed

Fixed AGP/PCI Output Freq

This item allows you to fix the AGP/PCI output frequency at 66MHz/33MHz. You may need to adjust this value when over-clocking is unsuccessful.
Options: Disabled (default) - 66MHz/33MHz

CPU:AGP Clock Ratio

This item allows you to adjust your CPU:AGP clock ratio. The result displays as the AGP/PCI frequency. Options: Auto (default) - 1.5X - 2.0X - 2.5X

DDR:CPU Ratio

This item allows you to adjust your DRAM: CPU Clock Ratio. This option allows you to over-clock the system.

When CPU host frequency is set to 100 → Options: Auto (default) - 1.50X (Debug Mode) - 2.50X - 2.66X

When CPU host frequency is set to 133 → Options: Auto (default) - 2.00X - 2.50X - 2.66X (Turbo Mode)

AGP Voltage (Volt)

This item allows you to adjust the AGP Voltage. Options: 1.5 (default) - 1.6

DDR Voltage (Volt)

This item allows you to adjust the RAM voltage. Options: 2.5 (default) - 2.6 - 2.7 - 2.8

Integrated Peripherals

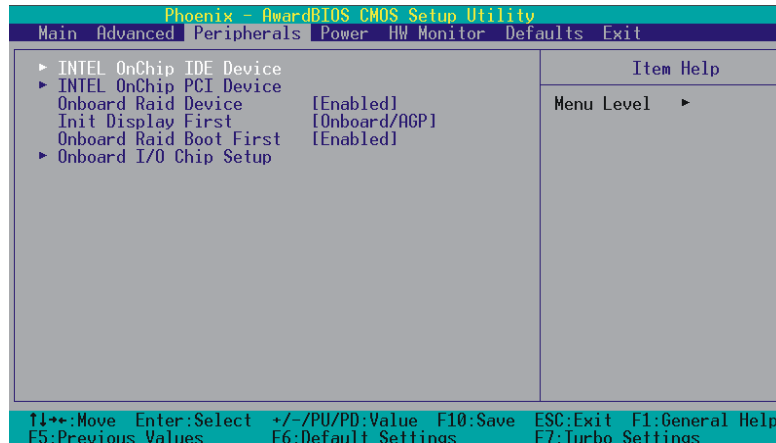

INTEL OnChip IDE Device

If you highlight the “INTEL OnChip IDE Device” label and then press the enter key, it will take you to a submenu with the following options:

On-Chip Primary/Secondary PCI IDE

The mainboard chipset contains a PCI IDE interface with support for two IDE channels. Select “Enabled” to activate the first and/or second IDE interface. Select “Disabled” to deactivate the interface if you are going to install a primary and/or secondary add-in IDE interface. Options: Enabled (default) · Disabled

IDE Primary/Secondary/Master/Slave PIO

The IDE PIO (Programmed Input / Output) fields let you set a PIO mode (0-4) for each of the IDE devices that the onboard IDE interface supports. Modes 0 to 4 will increase performance incrementally. In Auto mode, the system automatically determines the best mode for each device. Options: Auto (default) · Mode0 · Mode1 · Mode2 · Mode3 · Mode4.

IDE Primary / Secondary /Master / Slave UDMA

Ultra DMA/100 functionality can be implemented if it is supported by the IDE hard drives in your system. As well, your operating environment requires a DMA driver (Windows 95 OSR2 or a third party IDE bus master driver). If your hard drive and your system software both support Ultra DMA/100, select “Auto” to enable BIOS support.

Options: Auto (default) · Disabled

IDE HDD Block Mode

Block mode is otherwise known as block transfer, multiple commands, or multiple sector read/write. Select the “Enabled” option if your IDE hard drive supports block mode (most new drives do). The system will automatically determine the optimal number of blocks to read and write per sector. Options: Enabled (default) \ Disabled

INTEL OnChip PCI Device

If you highlight the “INTEL OnChip PCI Device” label and then press the enter key, it will take you a submenu with the following options:

USB Controller

This option should be enabled if your system has a USB port installed on the system board. You will need to disable this feature if you add a higher performance controller.

Options: Enabled (default) \ Disabled

USB 2.0 Controller

This option should be enabled if your system has a USB 2.0 device installed on the system board. You will need to disable this feature if you install a USB 1.1 device.

Options: Enabled (default) \ Disabled

USB Keyboard Support

Enables support for USB attached keyboards. Options: Disabled (default) \ Enabled

AC'97 Audio

This option allows you to control the onboard AC'97 audio.

Options: Auto (default) \ Disabled

Onboard LAN Device

This option allows you to control the onboard LAN Device.

Options: Enabled (default) \ Disabled

Onboard Raid Device

This option allows you to control the onboard RAID Device.

Options: Enabled (default) \ Disable

Init Display First

With systems that have multiple video cards, this option determines whether the primary display uses a PCI slot or an AGP slot. Options: Onboard/AGP (default) \ PIC Slot

Onboard Raid Boot First

This option allows you to enabled or disabled the Raid device to boot first.

Options: Enabled (default) \ Disable

Onboard I/O Chip Setup

If you highlight the “Onboard I/O Chip Setup” label and then press the enter key, it will take you to a submenu with the following options:

PWRON After PWR-Fail

This field will determine whether your system will boot after restoring power after a power failure. If you select “On”, the system will boot whether or not the system was on before power failure. If you select “Former-Sts”, the system will be restored to the status before the power failure. Options: Off (default) \ On \ Former-Sts

Power On Function

This option allows you to select a way to power on your computer. Options: Password \ Hot KEY \ Mouse Left \ Mouse Right \ Any KEY \ BUTTON ONLY (default), and Keyboard 98

KB Power On Password

Supply a password that your system will use as part of the power-on sequence.

Hot Key Power ON

This option allows you to use the Ctrl key along with a hot key (function key) to power on your system. Options: Ctrl-F1 \ Ctrl-F2..... Ctrl-F12

Onboard FDC Controller

Select “Enabled” if your system has a floppy disk controller (FDC) installed on the system board and you wish to use it. If you install an add-in FDC or the system has no floppy drive, select “Disabled”. Options: Enabled (default) \ Disabled

Onboard Serial Port 1/ Port 2

Select an address and corresponding interrupt for the first/ second serial port.
Options: Disabled \ 3F8/IRQ4 (default for port1) \ 2F8/IRQ3(default for port2) \ 3E8/IRQ4 \ 2E8/IRQ3 \ Auto

UART Mode Select

This item allows you to select the Infra Red (IR) standard to be used.
Options: Normal (default) \ AS KIR \ IrDA

RxD, TxD Active

This item determines the RxD and TxD frequencies.
Options: Hi / Lo (default) \ Hi / Hi \ Lo / Hi \ Lo / Lo

IR Transmission Delay

This item allows you to enable/disable IR transmission delay.
Options: Enabled (default) \ Disabled

UR2 Duplex Mode

Select the transmission mode used by the IR interface. Full-duplex mode permits simultaneous bi-directional transmission. Half-duplex mode permits transmission in only one direction at a time. Options: Half (default) ∙ Full

Use IR Pins

Consult your IR peripheral documentation to select the correct setting of the TxD and RxD signals. Options: Full ∙ Half (default)

Onboard Parallel Port

Select an address and corresponding interrupt for the onboard parallel port. Options: 378/IRQ7 (default) ∙ 278/IRQ5 ∙ 3BC/IRQ7 ∙ Disabled

Parallel Port Mode

This option allows you to select a parallel port mode for the on board parallel port.

ECP(default)	Extended Capabilities Port.
EPP	Enhanced Parallel Port.
SPP	Standard Printer Port.
ECP+EPP	ECP & EPP mode.
Normal	

EPP Mode Select

Select EPP port type 1.7 or 1.9. Options: EPP 1.9(default) ∙ EPP 1.7

ECP Mode Use DMA

Select a DMA Channel for the parallel port during ECP mode. Options: 3 (default) ∙ 1

Game Port Address

Game Port I/O Address. Options: 201 (default) ∙ 209 ∙ Disabled

Midi Port Address

Midi Port Base I/O Address. Options: 330 ∙ 300 (default) ∙ 290 ∙ Disabled

Midi Port IRQ

This determines the IRQ that the Midi Port will use. Options: 5 ∙ 10 (default)

Power Management

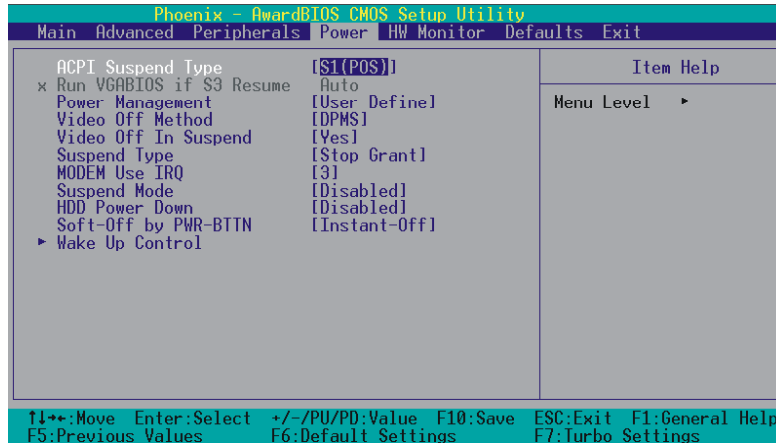

The Power Management Setup Menu allows you to configure your system to utilize energy conservation features as well as power-up/ power-down options.

ACPI Suspend Type

The item allows you to select the suspend type using the ACPI operating system.

Options: S1 (POS) (default) Power on Suspend
 S3 (STR) Suspend to RAM
 S1 & S3 POS and STR

Run VGABIOS if S3 Resume

Select whether you want to run VGABIOS when the system wakes up from the S3 resume function. Options: Auto (default) \ Yes \ No

Power Management

There are three options of Power Management:

1. Min. Power Saving
 Minimum power management
 Suspend Mode = 1hour
 HDD Power Down = 30 minutes

2. Max. Power Saving
 Maximum power management (only available for sl CPUs).
 Suspend Mode = 1 min.
 HDD Power Down = 6 min.

3. User Defined (default)

Allows you to set each mode individually.

When this option is enabled, each of the ranges are from 1 min. to 1 hr. except for HDD Power Down, which ranges from 1 min. to 15 min. and includes a “disable” option.

Note: If you select Min. or Max. Power Saving modes, the “HDD Power Down” value and the “Suspend Mode” value are both fixed.

Video Off Method

This option determines the manner in which the monitor goes blank.

Options:

V/H SYNC+Blank This selection will cause the system to turn off the vertical and horizontal synchronization ports and write blanks to the video buffer.

Blank Screen (default) This option only writes blanks to the video buffer.

DPMS Support Initial display power management signaling.

Video Off In Suspend

This determines whether power to the monitor is switched off when the computer is in suspend mode. Options: Yes ∙ No (default)

Suspend Type

This item allows you to select the suspend type under the ACPI operating system.

Options: Stop Grant (default) ∙ PwrOn Suspend

Modem Use IRQ

This determines the modem’s IRQ. Options: 3 (default) ∙ 4 ∙ 5 ∙ 7 ∙ 9 ∙ 10 ∙ 11 ∙ NA.

Suspend Mode

This item allows you to select the suspend time under the ACPI operating system.

Options: Disabled(default) ∙ 1Min ∙ 2Min ∙ 4Min ∙ 6Min ∙ 8Min ∙ 10Min ∙ 20Min ∙ 30Min ∙ 40Min ∙ 1Hour

HDD Power Down

When enabled, the hard disk drive will power down after a certain configurable period of system inactivity. All other devices remain active.

Options: Disabled (default) ∙ 1 Min ∙ 2 Min ∙ 3 Min ∙ 4 Min ∙ 5 Min ∙ 6 Min ∙ 7 Min ∙ 8 Min ∙ 9 Min ∙ 10 Min ∙ 11 Min ∙ 12 Min ∙ 13 Min ∙ 14 Min ∙ 15Min

Soft-Off by PWRBTN

Pressing the power button for more than 4 seconds forces the system to enter the Soft-Off state when the system has “hung.”

Options: Delay 4 Sec, Instant-Off (default).

Wake Up Control

If you highlight the “Wake Up Control” label and then press the enter key, it will display a submenu with the following options:

PCI PME Wake Up

When you select “Enabled”, a PME signal from any PCI 2.2 card will awaken the system. And if you want to awake from onboard LAN that you can enable this item, too.
Options: Disabled (default) · Enabled

RTC Wake Up

When “Enabled”, you can set the date and time at which the RTC (real-time clock) alarm awakens the system from Suspend mode. Options: Enabled · Disabled (default).

Date of Month Alarm

You can choose which date of the month the system will boot up. This field is only configurable when “RTC Wake Up” is set to “Enabled”.

Time (hh: mm: ss) Alarm

You can choose the hour, minute and second the system will boot up. This field is only configurable when “RTC Wake Up” is set to “Enabled”.

USB KB Wake-up From S3

This item allows you to awaken the system from suspend mode using a USB keyboard.
Options: Enabled · Disabled (default)
* This option is active when the ACPI Suspend Type is set to S3.

LAN Wake Up

This option allows you to awaken the system from suspend mode after receiving LAN data. To use this function, you need a LAN add-on card which supports power on functions, as well as the wake-up on LAN jumper. Options: Disabled (default), Enabled

Ring Wake Up

This option allows you to awaken the system upon receiving an incoming call to modem device. Options: Disabled (default) · Enabled.

Reload Global Timer Events

When a system goes into suspend mode, certain devices must be inactive for a period of time. Conversely, if any of those devices have any activity, the system will awaken. You can select the devices that will participate in suspend/power-on activity by configuring these fields. Devices include: Primary IDE 0/ Primary IDE 1/ Secondary IDE 0/ Secondary IDE 1/ FDD,COM,LPT Port/ PCI PIRQ [A-D]#. Options: Disabled (default), Enabled

Hardware Monitor

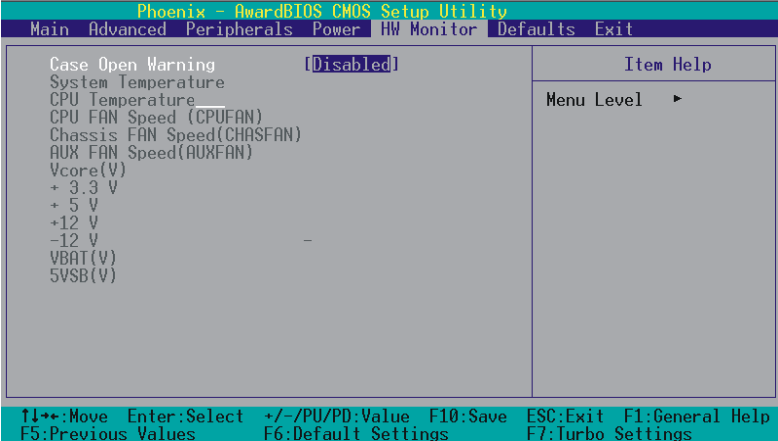

Case Open Warning

If this function is set to “Enabled” and the case had been previously opened, the system will automatically display alert messages on the screen when you power on your computer. If this function is set to “Disabled”, the system will not show alert messages when you power on your computer even if the case is opened by others.

Options: Disabled (default) \ Enabled

Load Defaults

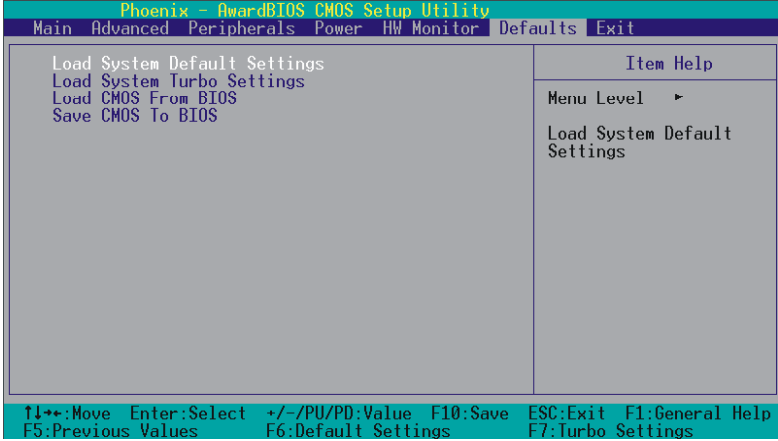

Load System Default Settings

Load System Default Settings.

Load System Turbo Settings

Load System Turbo Settings.

Load CMOS From BIOS

Load defaults from flash ROM for systems without batteries.

Save CMOS To BIOS

Save defaults to flash ROM for systems without batteries.

Exit Menu

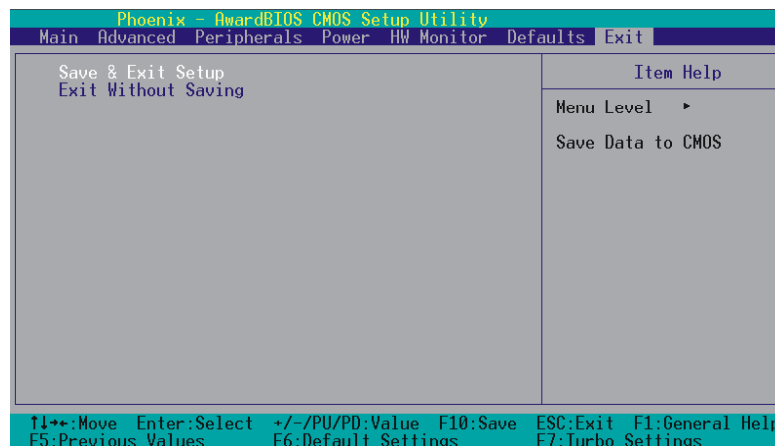

Save & Exit Setup

Save all configuration changes to CMOS (memory) and exit setup. A confirmation message will be displayed before proceeding.

Exit Without Saving

Abandon all changes made during the current session and exit setup. A confirmation message will be displayed before proceeding.

Chapter 3: Software Setup

Software List

Category	Platform
Intel Chipset INF update	Windows 9X /ME /2000 /XP
Intel IAA Utility(IAA)	
Intel 845 Extreme Graphics Driver	
Realtek Audio Driver	
Promise RAID Driver	
Promise SATA Driver	
Intel Lan Driver	
PC-Cillin 2002	
Acrobat Reader 5.0	

Software Installation

Place the Driver CD into the CD-ROM driver and the Installation Utility will auto-run. You can also launch the Driver CD Installation Utility manually. Follow the steps below:

1. The first screen (Main Screen) will display five buttons. Click "PX845GE/PX845PE(PRO/PROII)".

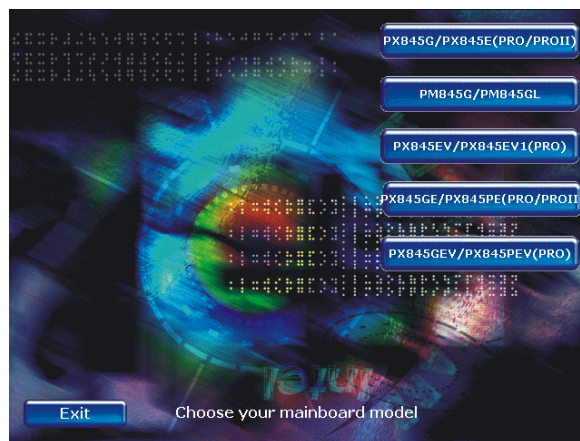

PX845PE/GE Series

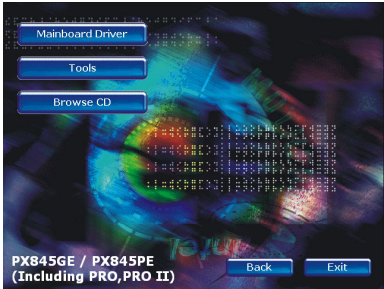

2. On the “PX845GE/PX845PE(PRO/PROII)” screen, click “Mainboard Driver”.



3. On the “Mainboard Driver” screen, use the buttons displayed on the screen to install their respective software.



4. By clicking “Tools” from the screen in step 2, the screen below will be displayed with options to install two programs. Follow the instructions on the screen after clicking the buttons.

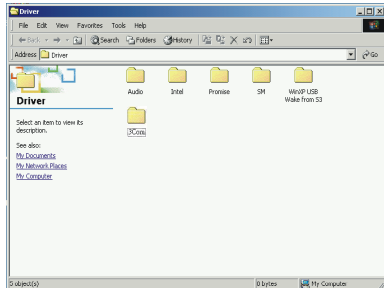

5. If you click the “Browse CD” button from the screen in step 2, you can browse all the files in the Driver CD.

Note: You can click the “Exit” button on any screen to exit the Driver CD utility.

Super 5.1 Channel Setup

1. After into the system, click the audio icon  from the Windows screen.
2. Click Speaker Configuration button, you can see the screen like the picture below.
3. You can choice 2, 4 or 6 channels by your speakers.

2 Channel

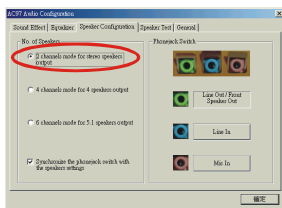

4 Channel

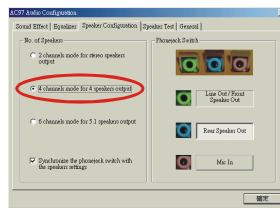

6 Channel

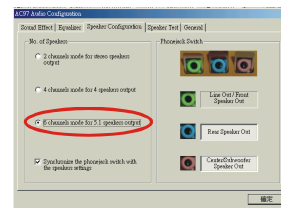

Super 5.1 Channel Audio Effect

This mainboard comes with an ALC650 Codec which supports high quality 5.1 Channel audio effects. With ALC650, you are able to use standard line-jacks for surround audio output without connecting to any auxiliary external modules. To use this function, you have to install the audio driver in the bonus Pack CD as well as an audio application supporting 5.1 Channel audio effects. See the audio Port Connectors in the Hardware Installation section for a description of the output connectors.

Speaker Test

- Make sure the cable is firmly into the connector.
Click the audio icon  from the Windows screen.
1. Click Speaker Test button, you can see the screen like the pictures below.
 2. Select the speaker which you want to test and clicking on it.
 3. Select the speaker which you want to test by clicking on it.

2 Channel



4 Channel

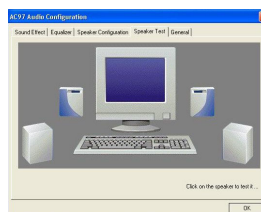

6 Channel

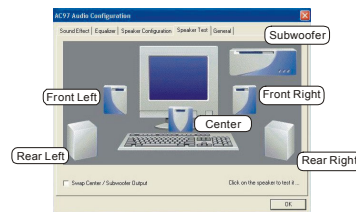

Chapter 4: Troubleshooting

Problem 1:

No power to the system. Power light does not illuminate. Fan inside power supply does not turn on. Indicator lights on keyboard are not lit.

Causes:

1. Power cable is unplugged.
2. Defective power cable.
3. Power supply failure.
4. Faulty wall outlet; circuit breaker or fuse blown.

Solutions:

1. Make sure power cable is securely plugged in.
2. Replace cable.
3. Contact technical support.
4. Use different socket, repair outlet, reset circuit breaker or replace fuse.

Problem 2:

System inoperative. Keyboard lights are on, power indicator lights are lit, hard drive is active but system seems "hung"

Causes: Memory DIMM is partially dislodged from the slot on the mainboard.

Solutions:

1. Power Down
2. Using even pressure on both ends of the DIMM, press down firmly until the module snaps into place.

Problem 3:

System does not boot from the hard disk drive but can be booted from the CD-ROM drive.

Causes:

1. Connector between hard drive and system board unplugged.
2. Damaged hard disk or disk controller.
3. Hard disk directory or FAT is corrupted.

Solutions:

1. Check the cable running from the disk to the disk controller board. Make sure both ends are securely attached. Check the drive type in the standard CMOS setup.
2. Contact technical support.
3. Backing up the hard drive is extremely important. Make sure you periodically perform backups to avoid untimely disk crashes.

Problem 4:

System only boots from the CD-ROM. The hard disk can be read and applications can be used but booting from the hard disk is impossible.

Causes: Hard Disk boot sector has been corrupted.

Solutions: Back up data and applications files. Reformat the hard drive. Re-install applications and data using backup disks.

Problem 5:

Error message reading “SECTOR NOT FOUND” displays and the system does not allow certain data to be accessed.

Causes: There are many reasons for this such as virus intrusion or disk failure.

Solutions: Back up any salvageable data. Then performs low level format, partition, and then a high level format the hard drive. Re-install all saved data when completed.

Problem 6:

Screen message says “Invalid Configuration” or “CMOS Failure.”

Causes: Incorrect information entered into the BIOS setup program.

Solutions: Review system’s equipment. Reconfigure the system.

Problem 7:

The Screen is blank.

Causes: No power to monitor.

Solutions: Check the power connectors to the monitor and to the system.

Problem 8:

Blank screen.

Causes:

1. Memory problem.
2. Computer virus.

Solutions:

1. Reboot computer. Reinstall memory. Make sure that all memory modules are securely installed.
2. Use anti-virus programs to detect and clean viruses.

Problem 9:

Screen goes blank periodically.

Causes: Screen saver is enabled.

Solutions: Disable screen saver.

Problem 10:

Keyboard failure.

Causes: Keyboard is disconnected.

Solutions: Reconnect keyboard. Replace keyboard if you continue to experience problems.

Problem 11:

No color on screen.

Causes:

1. Faulty Monitor.
2. CMOS incorrectly set up.

Solutions:

1. If possible, connect monitor to another system. If no color appears, replace monitor.
2. Call technical support.

Problem 12:

The screen displays "C: drive failure."

Causes: Hard drive cable not connected properly.

Solutions: Check hard drive cable.

Problem 13:

Cannot boot the system after installing a second hard drive.

Causes:

1. Master/slave jumpers not set correctly.
2. Hard drives are not compatible / different manufacturers.

Solutions:

1. Set master/slave jumpers correctly.
2. Run SETUP program and select the correct drive types. Call drive manufacturers for possible compatibility problems with other drives.

Problem 14:

Missing operating system on hard drive.

Causes: CMOS setup has been changed.

Solutions: Run setup and select the correct drive type.

Problem 15:

Certain keys do not function.

Causes: Keys jammed or defective.

Solutions: Replace keyboard.