

# Table of Contents

---

## Chapter 1 Introduction of PX5N/TX5N Features

① PX5N	
● Specifications .....	1-2
● Layout diagram .....	1-4
② TX5N	
● Specifications... ..	1-5
● Layout diagram ... ..	1-8
③ System block diagram.....	1-9

## Chapter 2 Installing the Mainboard

① Installing the Mainboard to the Casing .....	2-3
② Standard External Connectors.....	2-4
③ Jumpers and Switches .....	2-11
④ Presentation and Installation of the CPU .....	2-12
⑤ Installing System Memory ; i DRAM Memory ; j .....	2-20

## Chapter 3 Introduction of BIOS

① Standard CMOS Setup Menu.....	3-4
② BIOS Features Setup Menu .....	3-6
③ Chipset Features Setup Menu.....	3- 2
④ Power Management Menu .....	3 14
PC & On board I/O Setup .....	3 18
Load IO Defaults .....	3- 3
⑦ Load Setup Defaults .....	3- 3
⑧ Password Set .....	3- 4
⑨ Delete Advanced Settings .....	-2

- Appendix A** Quick Installation
- Appendix B** Intel Pentium CPUs
- Appendix C** AMD-K5 CPUs
- Appendix D** Cyrix / IBM 6x86 CPUs
- Appendix E** General Discussion about HDD Installation
- Appendix F** Technical Support
- Appendix G** Flash BIOS User Instructions
- Appendix H** How to install Ultra DMA/33 drive
- Appendix I** How to install PCI Bridge Batch file

# Chapter 1 Introduction of PX5N/TX5N Features

---

The PX5N/TX5N has been especially designed for File server, Workstation and Professional users. It can support a wide range of processors, including all Intel CPUs (P54C) and Intel CPUs with MMX (P55C), as well as all AMD-K5/K6 and Cyrix 6x86/6x86L/6x86MX CPUs. It also takes into account, as much as possible, all future CPUs.

The PX5N/TX5N uses DIP switches or jumpers.

The PX5N/TX5N uses Intel 430TX series chipsets, and has 512 Level 2 cache. It also has a 2.1A floppy disk controller.

The PX5N/TX5N has 18-pin DIMM slots and 7-pin IDE (ATA) slots. It also has a 16-pin IDE slot for the hard disk drive. The PX5N/TX5N has a 68-pin IDE slot for the floppy disk drive. The PX5N/TX5N has a 68-pin IDE slot for the floppy disk drive.

The PX5N/TX5N also supports the USB ports and the IEEE 1394 interface. It also supports the IDE interface and the SCSI interface. The PX5N/TX5N also supports the IDE interface and the SCSI interface.

System BIOS features include Plug-and-Play (PnP), Advanced Configuration Power Interface (ACPI), the newest Desktop Management Interface (DMI), as well as PX5N/TX5N's unique CPU operating frequency and voltage setup feature in order to meet modern computing demands.

① **PX5N**● **Specifications**

1. Supports AT power supply
  - Supports AT power supply
  - Supports AT power supply
  - Supports AT power supply
3. Uses ZIF CPU Socket 7 for easy CPU installation
  - Supports switching power for a more stable environment for the CPU
  - Supports Intel CPUs:
    - 1) Pentium® 100MHz to 200MHz
    - 2) Pentium® processor with MMX™ technology 166MHz to 233MHz
  - Supports AMD CPUs:
    - 1) AMD-K5™ PR100 to PR166.
    - 2) AMD-K6™ 166MHz, 200MHz, 233MHz, 266MHz and 300MHz.
  - Supports Cyrix/IBM CPUs:
    - 1) Cyrix 6x86™ P120+, P133+, P150+, P166+, P200+.
    - 2) Cyrix 6x86L™ P150+ ~ P200+.
    - 3) Cyrix 6x86MX™ PR150 ~ PR233.
  - Reserved circuitry supports future sixth generation CPUs
4. Chipset
  - Intel 430TX chipset
  - Supports standard version PCI 2.1
5. L2 Cache Memory
  - 512K of cache memory (Pipeline Burst SRAM)
6. System DRAM
  - **Two** 72-pin **SIMM** sockets: support FP and EDO DRAM
  - **Two** 168-pin **DIMM** sockets: support FP, EDO and Synchronous DRAM (SDRAM)

- DIMM sockets use PC modules (3.3V Unbuffered DRAM)
- Up to 256MB memory configuration possible

7. System BIOS

- AWARD BIOS
- Supports Plug-and-Play (PnP)
- Supports Advanced Configuration Power Interface (ACPI)
- Supports Desktop Management Interface (DMI)

8. Multi I/O features

- Two Universal Serial Bus (USB) ports
- Four fast IDE channels (PIO mode 0~4, Ultra "DMA/33" and Bus Master)
- One standard EPP/ECP parallel port and two 16550 serial ports
- Two floppy disk drives (FDD) (3.0K 7.0K 1.2M 1.4M and 2.88 )
- Supports PS/2 keyboard

9. Other features

- Standard Termination resistors
- For SA bus and PDI units
- Support 3MOE or a special Japanese floppy disk drive
- Support to load external disk -- built in two different operation systems
- Supports IDE interface CD-ROM and LS-120 type floppy drive (optionally)
- X5 uses a DIP switch to configure the main board, RDIP which is used to set the PU voltage-CORE and VIO. The BLUE DIP switch is used to setup the CPU Frequency and Rating.

Note: All brand names and trademarks are the property of their respective owners.

- **Layout diagram**

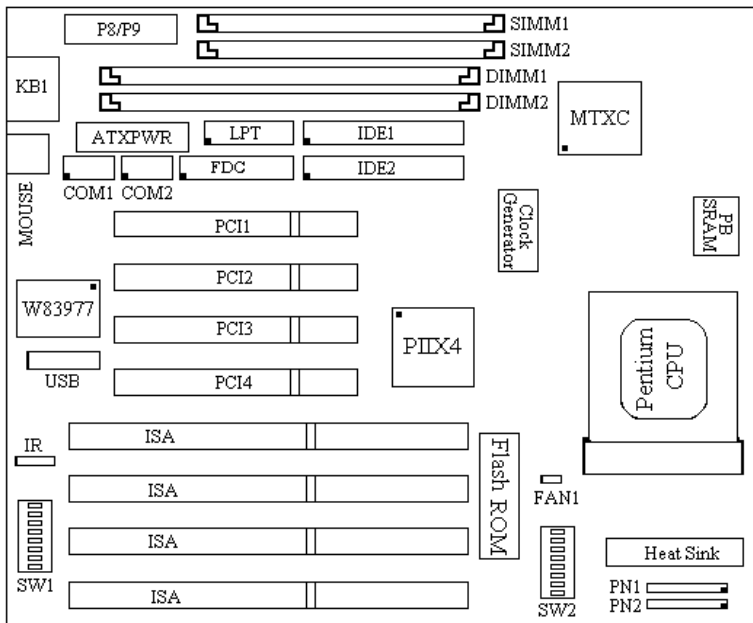

***AB-PX5N***

Fig 1-2 Layout diagram

## ② TX5N

---

### ● Specifications

1. Supports AT and ATX power supply
2. Adjustment for Frequency and Voltage
  - Using DIP switch or jumper wires to adjust the frequency and voltage on the mainboard
  - TX5N does not support CPU SOFT MENU.
3. Uses ZIF CPU Socket 7 for easy CPU installation
  - Supports switching power for a more stable environment for the CPU
  - Supports Intel CPUs:
    - 1) Pentium® 120MHz to 200MHz
    - 2 ) Pentium® processor with MMX™ technology 166MHz to 233MHz
  - Supports AMD CPUs:
    - 1 ) AMD-K5™ PR120 to PR166.
    - 2) AMD-K6™ 166MHz ~ 233MHz.
  - Supports Cyrix/IBM CPUs:
    - 1) Cyrix 6x86™ P150+ ~ P200+.
    - 2) Cyrix 6x86L™ P150+ ~ P200+.
    - 3) Cyrix 6x86MX™ PR150 ~ PR233 .
  - Reserved circuitry supports future Processors .
4. Chipset
  - Intel 430TX chipset
  - Supports standard version PCI 2.1
5. L2 Cache Memory
  - 512K of cache memory (Pipeline Burst SRAM)
6. System DRAM
  - **Four** 72-pin **SIMM** sockets: support FP and EDO DRAM
  - **Two** 168-pin **DIMM** sockets: support FP, EDO and Synchronous DRAM (SDRAM)
  - DIMM sockets use PC modules (3.3V Unbuffered DRAM)



- Up to 256MB memory configuration possible

7. System BIOS

- AWARD BIOS
- Supports Plug-and-Play (PnP)
- Supports Advanced Configuration Power Interface (ACPI)
- Supports Desktop Management Interface (DMI)

8. Multi I/O features

- Two Universal Serial Bus (USB) ports
- Four fast IDE channels (PIO mode 0~4, Ultra “DMA/33” and Bus Master)
- One standard EPP/ECP parallel port and two 16550 serial ports
- Two floppy disk drive connectors (FDD) (360K, 720K, 1.2M, 1.44M and 2.88M)
- Supports PS/2 type mouse

9. Other features

- Standard AT architecture dimensions
- Three ISA bus slots and four PCI bus slots
- Supports **3-MODE** for a special Japanese floppy disk drive
- Supports two bootable hard disks--able to run two different operating systems
- Supports IDE interface CD-ROM and LS-120 type floppy disk drive (Boot only)
- TX5N uses a DIP switch to configure the mainboard, a RED DIP switch is use to setup the CPU voltage-V<sub>CORE</sub> and V<sub>IO</sub>. The BLUE DIP switch is used to setup the CPU Frequency and Rating.

**Computer  
Knowledge**

The EISCA (Enhanced Intelligent System Cooler Architecture) is a specially designed 12-pin interface which integrates the Mainboard and the CPU cooling system. This system is a total solution for PC system with heat sink problems. Due to increasing CPU speed, which causes higher temperatures, finding ways to effectively deal with CPU temperatures is becoming a more and more crucial problem. Effectively and precisely determining CPU temperature was a very important requirement of Microsoft PC '97. The area directly under the CPU socket is the location on the mainboard closest to the CPU, and heat is conducted away from this area through air circulation. Determining temperature change under these circumstances is very imprecise, as it only allows us to detect large changes in temperature. In addition, because the air under the CPU socket is confined to this area, the sensor cannot detect temperature in real time. Tests have proven that under such circumstances, even after 5 minutes, the sensor located under the CPU socket is unable to detect real temperature change, so it can not meet the requirements for thermal problems.

In EISCA architecture, the thermal sensor is located at the heat-sink. In this way, the sensor is able to detect CPU temperature in real time and more precisely. The EISCA monitors voltage, fan speed and fan on/off control to meet Microsoft PC '97 specifications.

Note: All brand names and trademarks are the property of their respective owners.

- **Layout diagram**

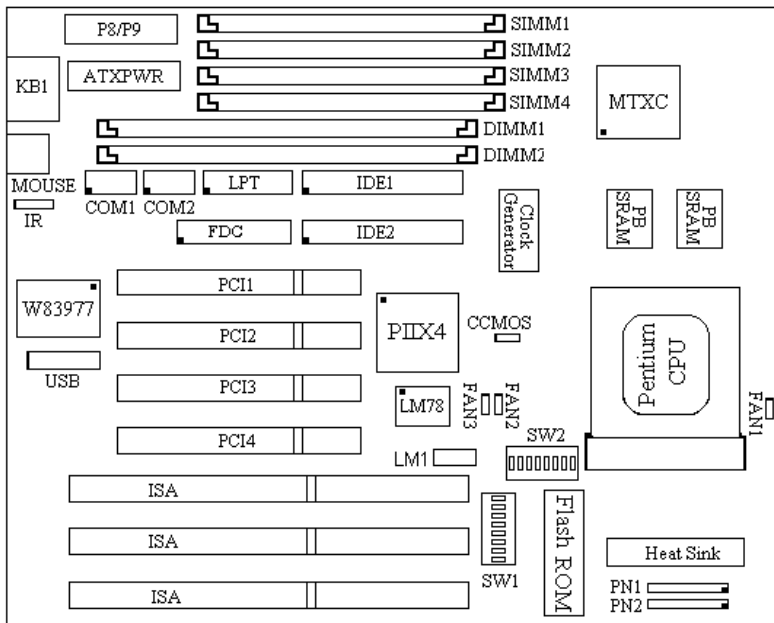

***AB-TX5N***

Fig 1-3 Layout diagram

### ③ System block diagram

---

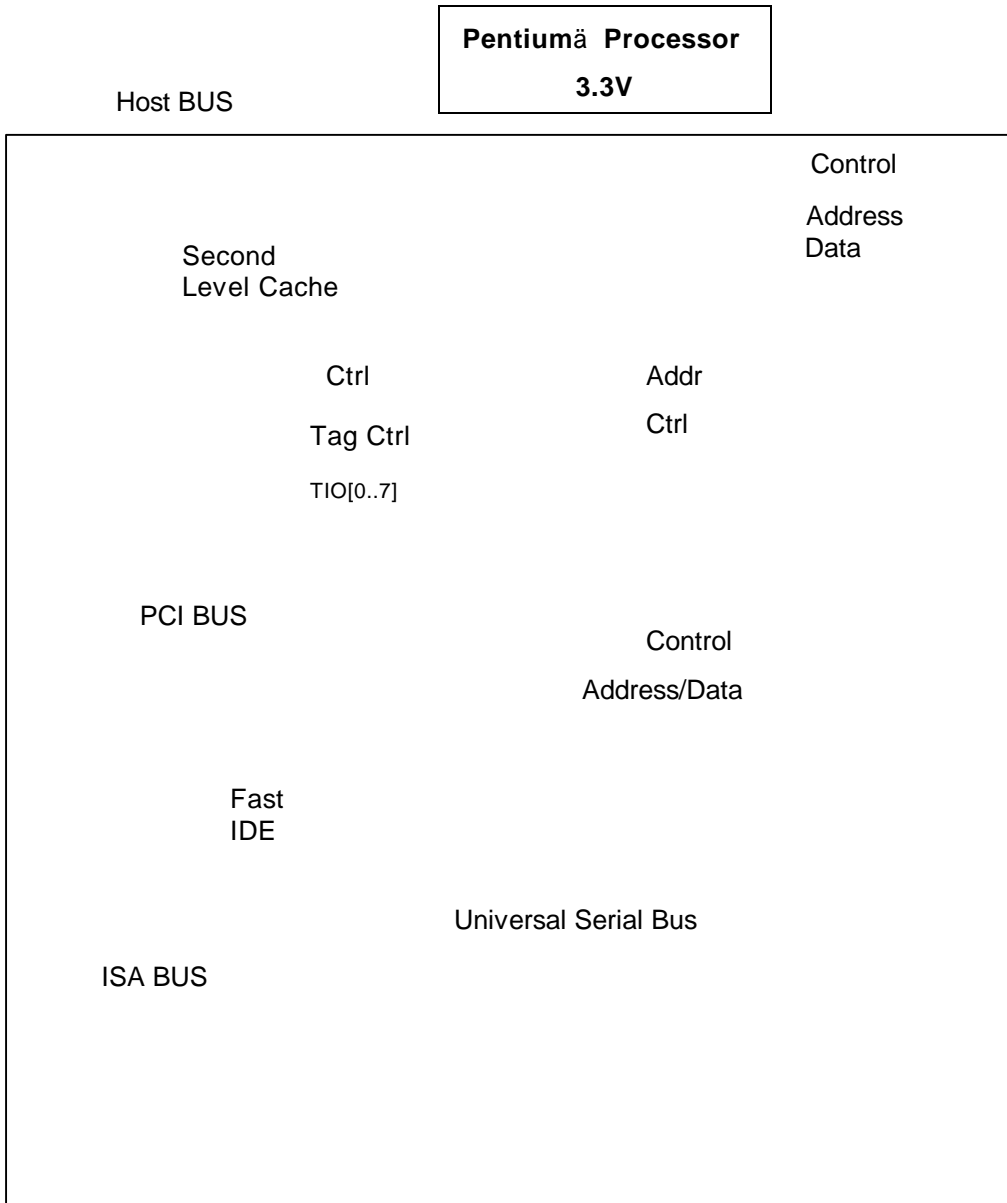

Fig. 1-4 PX5N/TX5N System block diagram

*Chapter 1* Introduction of PX5N/TX5N Features

*1-11*



## Chapter 2      Installing the Mainboard

---

This PX5N/TX5N mainboard not only can be used with all standard equipment for traditional personal computers, but also provides great flexibility for meeting future upgrade demands. This chapter will introduce step by step all the standard equipment and will also present, as completely as possible future upgrade capabilities. This mainboard is able to support all Intel Pentium chips including P55C with MMX, Cyrix 6x86, 6x86L, 6x86MX and AMD-K5/K6 processors now on the market. (For details, see specifications in Chapter 1.) However, we cannot guarantee the description given in this manual of the circuitry of your mainboard will work for processors not listed in Chapter 1. For example, the operating voltage of Cyrix's next generation CPU is unknown at present. Thus we were not able to include these specifications in your motherboard. We will supply further information about CPU support when new CPUs arrive on the market.

This chapter is organized according the following features:

- ❶ Standard external connectors
- ❷ Jumpers and switches
- ❸ Presentation and Installing of the CPU.
- ❹ Installing the system memory.



### **Before proceeding with the installation**

---

Before installing the mainboard please be sure to turn off or disconnect the power supply unit. Before making any modifications to the hardware configuration of the mainboard, the power supply to any areas of the mainboard you plan to modify should be turned off to avoid unnecessary damage to the hardware.



## **User friendly instructions**

---

Our objective is to enable the novice computer user to perform the installation by themselves. We have attempted to write this document in a very clear, concise and descriptive manner to help overcome any obstacles you may face during installation. Please read our instructions carefully and follow them step-by-step.





## **① Installing the Mainboard to the Casing**

---

Most computer cases will have a base on which there will be many mounting holes that allows the mainboard to be securely attached and at the same time, prevents short circuits.

There are two ways to attach the mainboard to the base.

- with spacers
- or with bolts

In principle, the best way to attach the motherboard is with bolts, and only if you are unable to do this should you attach the board with spacers. Take a careful look at the mainboard and you will see many mounting holes on it. Line these holes up with the mounting holes on the base. If the holes line up, and there are screw holes this means you can attach the mainboard with bolts. If the holes line up and there are only slots, this means you can only attach the mainboard with spacers. Take the tip of the spacers and insert it into the slots. After doing this to all the slots, you can slide the mainboard into position aligned with the slots. After the mainboard has been positioned, check to make sure everything is OK before putting the casing back on.

Note: If the mainboard has mounting holes, but don't line up with the holes on the base and there are no slots to attach the spacers, don't panic, you can still attach the spacers to the mounting holes. Just cut the spacers (along the dotted line) (the spacer may be a little hard so be careful of our hands). In this way you can still attach the mainboard to the base without worrying about short circuits.

### **Computer Knowledge**

Why is it that Cyrix is always raised in relation to IBM in books? In fact, these two 6\*86 CPUs (limited to the 6\*86 series) are basically the same thing. Because Cyrix does not have its own production line, it has contracted IBM to manufacture their 6\*86 CPUs for them. However, IBM has stipulated that the Cyrix CPUs they produce have both the Cyrix and IBM mark printed on it.

---

## ② Standard External Connectors

Inside the case of any computer several cables and plugs have to be connected. These cables and plugs are usually connected one-by-one to connectors located on the mainboard. You need to carefully pay attention to any connection orientation the cables may have and, if any, notice the position of the first pin of the connector. In the explanation that follows, we will describe the significance of the first pin.

### PN1

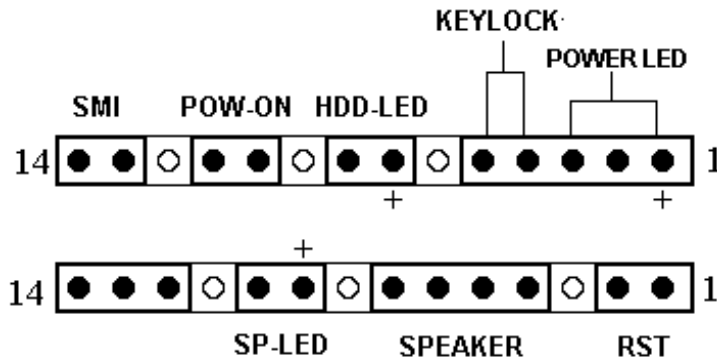

### PN2

**PN1 - Keylock connector** *Please pay attention to pin position and orientation*



This connector has a specific orientation. Connect the five-thread keylock connector cable to the PN1 connector pins on the mainboard.

Pin number	Name or significance of signal	
1	+5VDC	power LED
2	No connection	power LED
3	Ground	power LED
4	Keyboard inhibit Signal	key lock
5	Ground	key lock

**Computer Knowledge**

The “keylock switch” is used to lock the computer’s keyboard. This disables the keyboard so that unauthorized persons cannot use it. When this function is in use, you will need to use the unlock key to activate the keyboard.

**PN1 - Power ON/OFF switch**

There is no specific orientation. Since most cases do not support this feature, most of you should ignore this instruction.

Pin number	Name or significance of the signal
10	Power on/off
11	Ground

**PN1 - SMI Switch**

There is no specific orientation. Connect the two-thread cable to the PN1 connector pins on the mainboard. Since most cases do not support this feature, most of you should ignore this instruction. Furthermore, this feature is not necessary as it is already a part of the mainboard.

Pin number	Name or significance of signal
13	+VDD
14	Suspend

**PN1 - HDD LED connector**

This connector has a specific orientation. Connect the two-thread IDE LED connector cable attached to the case to the IDE LED connector on the mainboard.

Pin number	Name or significance of signal
7	LED’s Cathode
8	LED’s Anode

**PN2 - Speaker connector**

There is no specific orientation. Connect the four-thread speaker cable to the PN2 connector pins on the mainboard.

Pin number	Name or significance of signal
4	+5VDC
5	Ground
6	Ground
7	Sound Signal

**PN2 - Hardware Reset connectors**

There is no specific orientation. Connect the two-thread hardware reset cable to the PN2 connector pins on the mainboard.

Pin number	Name or significance of signal
1	Hardware reset signal
2	Ground

**PN2 - Sleep LED connector**

This connector has a specific orientation. Connect the two-thread Sleep LED connector cable attached to the case to the Sleep LED connector on the mainboard.

Pin number	Name or significance of signal
9	LED's Cathode
10	LED's Anode

**FAN1 - CPU Fan power connector (PX5N)**

This has a specific orientation. Connect the three-threads CPU fan cable to the FAN1 connector.

Pin number	Name of the signal or signification
1	Ground
2	+12V
3	Ground

**FAN1 - CPU Fan power connector (TX5N)**

This has a specific orientation. Connect the three-threads CPU fan cable to the FAN1 connector. FAN2 and FAN3 are the same. You can connect them to the heat sink.

Pin number	Name of the signal or signification
1	Sensor signal
2	+12V
3	Control on/off

If, at the bottom of the fan, there are only two threads, just connect them to PIN2 and PIN3.

**IR - Infrared remote Connectors** *Watch the pin number and the orientation*

This has a specific orientation. Your mainboard supports this feature, but you must buy the infrared remote device as an option.

Pin number	Name of the signal or signification
1	+5VDC
2	No connection
3	Receive data
4	Ground
5	Transmit data

**ATXPWR - ATX Power input Connectors**



These have a specific orientation. The three warning marks indicate that if you make a mistake in pin number or connection orientation, you could destroy your equipment. During installation, you just need to connect to the correct pins and in the correct orientation, and to connect the power supply unit to the connector on the mainboard.

Pin number	Name of the signal or signification	Pin number	Name of the signal or signification
1	+3.3VDC	11	+3.3VDC
2	+3.3VDC	12	-12VDC
3	Ground	13	Ground
4	+5VDC	14	PS_ON
5	Ground	15	Ground
6	+5VDC	16	Ground
7	Ground	17	Ground
8	POWERGOOD	18	-5VDC
9	+5VDC	19	+5VDC
10	+12VDC	20	+5VDC

**P8/P9 - AT Power input Connectors**



These have a specific orientation. The three warning marks indicate that if you make a mistake in pin number or connection orientation, you could destroy your equipment. During installation, you just need to connect to the correct pins and in the correct orientation, and to connect connectors P8 and P9 of the power supply unit to the connectors on the mainboard.

Pin number	Name of the signal or signification	Pin number	Name of the signal or signification
1	POWERGOOD	7	Ground
2	+5VDC	8	Ground
3	+12VDC	9	-5VDC
4	-12VDC	10	+5VDC
5	Ground	11	+5VDC
6	Ground	12	+5VDC

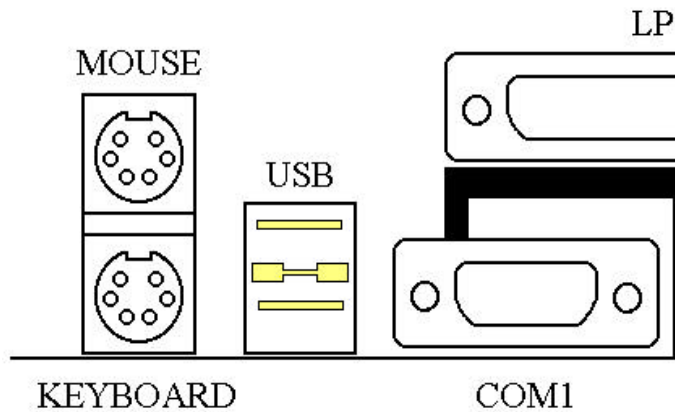

Mechanics of  
 Mouse/Keyboard/USB/COM1/COM2/L  
 PT (AX5N)

**Mouse - PS/2 Mouse connector** *Watch the pin number and the orientation*



This has a specific orientation. Connect the six-threads PS/2 Mouse cable provided to the connector on the mainboard.

Pin number	Name of the signal or signification
1	Mouse data
2	No connection
3	Ground
4	+5VDC
5	Ground
6	Mouse clock

**Computer knowledge**

The “PS/2 Mouse Port” is different from COM1 or COM2 serial ports to which you can also connect a Mouse. This mainboard features an extra PS/2 Mouse port, so when you buy a mouse, be sure that it is a PS/2 Mouse before connecting it to this port. But if you cannot find any PS/2 Mouse, you can still use COM1 or COM2 to connect a serial mouse to your computer.

**KB1 - Keyboard Connector** (PX5N/TX5N)

This has an orientation pin. Connect your keyboard connector to the connector on the mainboard.

Pin number	Name of the signal or signification
1	Keyboard clock
2	Keyboard data
3	No connection
4	Ground
5	+5VDC

**I/O Port connectors** *Watch the pin number and the orientation*

Connector name	Pin number	Name of the peripheral connected
IDE 1	40	IDE Channel 1
IDE 2	40	IDE Channel 2
FDC	34	Floppy Disk connector
LPT	26	Parallel port connector
COM1	10	Serial port COM1 connector
COM2	10	Serial port COM2 connector
USB	16	Universal Serial Bus connector

**LM1 - Enhanced Intelligent System Coller Architecture Connectors**  
**(TX5N)**

This has an orientation pin. Connect your EISCA connector to the connector on the mainboard.

Pin number	Name of the signal or signification
1	I <sup>2</sup> C Serial Bus Clock
2	I <sup>2</sup> C Serial Bus Data
3	Set for active low for wire interrupt line
4	Key
5	+5VDC
6	Alarm speaker output
7	Ground
8	Vcore detect
9	fan1 sensor input
10	Vio detect
11	fan2 sensor input
12	+12VDC

---



## ③ Jumpers and Switches

---

### **CCMOS : Delete the contents of the CMOS**

This jumper is set on pins 1 and 2 at the factory in order for the computer to function normally, so please do not change this setting. The main feature of this jumper is to solve situations where the computer crashes due to improper usage. For example:

- You have forgotten the password you set.
- You have inappropriately changed the settings in the BIOS menu.
- You want to change the flash BIOS version.

All these errors are very serious, you must avoid them. But if you have made one of these errors, this jumper can save your life. First turn off the power supply and open the computer case. Place the jumper on pins 2 and 3 in order to save your computer. But if you use your computer normally, you should not need to use this feature.

After you have deleted the CMOS information, the computer is saved, but you still have to go back to the BIOS Setup menu, and reset one by one all the specifications: CPU, date, hour, FDD and HDD parameters. etc., before your computer will return to normal operation.

## ④ **Presentation and Installation of the CPU**

---

Since 1996, every two or three months, Intel adds new models to the Pentium CPU series. That is why the CPU market is filled with a lot of different models and brands. All CPUs have different electrical specifications. That's why installing a CPU is becoming more and more complex. You can't help that, because everybody wants to be able to upgrade their hardware. So, you have to take a bit of time to read this section, in order to be able to install a cheaper and better processor.

The AX5N/PX5N/TX5N mainboard does not only support all the CPUs listed in the specifications, but also has reserved several circuits in order to be able to support future processors. But before we go further in our presentation, we must clarify that "we have only tested the CPUs listed in Chapter 1", we cannot guarantee that this board will be able to support future products, because we cannot forecast future developments. But we will do our best to support any possible CPU.

### **Related terminology :**

#### **External clock**

Also referred to as the external CPU clock, or "Bus clock", it is the input clock of the CPU. For instance, Intel Pentium P90, P120 and P150 all have a 60MHz external CPU clock, but have different internal clock multiplier factors.

#### **Clock multiplier factor**

The real operation clock within the CPU is the multiple of the external clock. We refer to this factor as the clock multiplier factor. The four factors possible are 1.5, 1.75, 2, 2.5, 3, 3.5, 4, 4.5, 5, 5.5. The factor differs from one CPU to another. For instance, the Intel Pentium 166 CPU has a 66MHz external clock, with a multiplier factor of 2.5, so that the speed of the internal clock is 66MHz x 2.5.

#### **Internal clock**

Also referred to as the real internal CPU clock, it is the actual internal operating clock of the CPU. The Internal Clock is a multiple of the external clock and of the clock multiplier factor. For instance, the Intel Pentium 90 CPU has a 60MHz external clock and its clock multiplier factor is 1.5; the Intel Pentium P133 CPU has a 66MHz external clock and its clock multiplier factor is 2.

Internal CPU clock = clock multiplier factor \* external CPU clock

**AT Bus clock**

Also referred to as ISA SPEED, or AT CLOCK, or even ISA Bus clock. Ten years ago, the original specification of AT Bus clock installed in the first generation PC/AT computers was 8MHz, this means that there are some interface cards which can only work at 8MHz. In order to guarantee compatibility with older hardware, we still support 8MHz AT Bus clock, but if your interface card is newer or faster, you can choose a higher speed for the AT Bus clock, in order to increase the transmission rate of the interface cards. But we recommend you not be too ambitious. An 8MHz setup ensures maximum compatibility.

**CPU Voltage - Vcore and Vio**

From the voltage point of view, 586 series CPU can be divided into two categories: single voltage CPU and dual voltage CPUs. Single voltage CPUs include: Intel Pentium P54C series, AMD-K5 and Cyrix 6x86, etc.

Dual voltage CPUs include: Intel P55C with MMX, future AMD-K6 CPUs, Cyrix 6x86L and 6x86MX.

The voltage of dual voltage CPUs has two components: Vcore and Vio. Vcore provides all the power for internal processing, and its power consumption is quite important. Vio provides the power necessary for the external interface of the CPU.

**P-Rating**

The P-Rating was defined by some manufacturers other than Intel to rate the performance of their CPU in comparison with Intel Pentium CPUs. For instance, Cyrix 6x86 P166+ has a higher actual speed compared with Intel Pentium P166, its internal clock needs only 133MHz versus 166MHz for Intel's product. The main reason is that Cyrix has improved the internal architecture of the 6x86 CPU, which means that with the same internal clock speed, the actual clock speed will be different.

Having read the related terminology above, please refer to the information in appendices B, C or D for the type and specifications of your own CPU. We suggest you note these specifications, which will help you when you install the CPU.

**Voltage and Frequency Setup**

PX5N/TX5N uses DIP switches to setup the CPU Frequency and voltage. Please make sure which kind of CPU and its frequency and voltage before you setup.

There are two DIP switches on the mainboard, one is use to setup the CPU frequency (including external clock and rating parameter) which is called SW1, another one is SW2 which is used to setup the CPU voltage.

**1.AX5N/PX5N/TX5N CPU frequency setting (SW1)**

The following tables will present the adjustment for the 586 CPU series.

Please setup the correct adjustment regarding the CPU type and brand.

**Clock Chip:PLL52C61-01H (PX5N/TX5N)**

<b>External Clock</b>	<b>DS6</b>	<b>DS7</b>	<b>DS8</b>
50MHz	ON	ON	ON
60MHz	ON	ON	OFF
66.6MHz	ON	OFF	ON
Test	ON	OFF	OFF
55MHz	OFF	ON	ON
75MHz	OFF	ON	OFF
83.0MHz	OFF	OFF	ON
68.4MHz	OFF	OFF	OFF

**Intel CPU (PX5N/TX5N)**

<b>Intel Pentium/with MMX</b>	<b>External Clock</b>	<b>Internal Clock</b>	<b>External Clock Factor</b>			<b>Reserve</b>		<b>External Clock Frequency</b>					
			<b>DS1</b>	<b>DS2</b>	<b>DS3</b>	<b>DS4</b>	<b>DS5</b>	<b>Normal</b>			<b>Turbo</b>		
								<b>DS6</b>	<b>DS7</b>	<b>DS8</b>	<b>DS6</b>	<b>DS7</b>	<b>DS8</b>
<b>P75</b>	<b>50MHz</b>	<b>75MHz</b>	<b>OFF</b>	<b>OFF</b>	<b>OFF</b>	<b>OFF</b>	<b>OFF</b>	<b>ON</b>	<b>ON</b>	<b>ON</b>	<b>---</b>	<b>---</b>	<b>---</b>
<b>P90</b>	<b>60MHz</b>	<b>90MHz</b>	<b>OFF</b>	<b>OFF</b>	<b>OFF</b>	<b>OFF</b>	<b>OFF</b>	<b>ON</b>	<b>ON</b>	<b>OFF</b>	<b>---</b>	<b>---</b>	<b>---</b>
<b>P100</b>	<b>66MHz</b>	<b>100MHz</b>	<b>OFF</b>	<b>OFF</b>	<b>OFF</b>	<b>OFF</b>	<b>OFF</b>	<b>ON</b>	<b>OFF</b>	<b>ON</b>	<b>OFF</b>	<b>OFF</b>	<b>OFF</b>
<b>P120</b>	<b>60MHz</b>	<b>120MHz</b>	<b>ON</b>	<b>OFF</b>	<b>OFF</b>	<b>OFF</b>	<b>OFF</b>	<b>ON</b>	<b>ON</b>	<b>OFF</b>	<b>---</b>	<b>---</b>	<b>---</b>
<b>P133</b>	<b>66MHz</b>	<b>133MHz</b>	<b>ON</b>	<b>OFF</b>	<b>OFF</b>	<b>OFF</b>	<b>OFF</b>	<b>ON</b>	<b>OFF</b>	<b>ON</b>	<b>OFF</b>	<b>OFF</b>	<b>OFF</b>
<b>P150</b>	<b>60MHz</b>	<b>150MHz</b>	<b>ON</b>	<b>ON</b>	<b>OFF</b>	<b>OFF</b>	<b>OFF</b>	<b>ON</b>	<b>ON</b>	<b>OFF</b>	<b>---</b>	<b>---</b>	<b>---</b>
<b>P166</b>	<b>66MHz</b>	<b>166MHz</b>	<b>ON</b>	<b>ON</b>	<b>OFF</b>	<b>OFF</b>	<b>OFF</b>	<b>ON</b>	<b>OFF</b>	<b>ON</b>	<b>OFF</b>	<b>OFF</b>	<b>OFF</b>
<b>P200</b>	<b>66MHz</b>	<b>200MHz</b>	<b>OFF</b>	<b>ON</b>	<b>OFF</b>	<b>OFF</b>	<b>OFF</b>	<b>ON</b>	<b>OFF</b>	<b>ON</b>	<b>OFF</b>	<b>OFF</b>	<b>OFF</b>
<b>P233</b>	<b>66MHz</b>	<b>233MHz</b>	<b>OFF</b>	<b>OFF</b>	<b>OFF</b>	<b>OFF</b>	<b>OFF</b>	<b>ON</b>	<b>OFF</b>	<b>ON</b>	<b>OFF</b>	<b>OFF</b>	<b>OFF</b>

**AMD CPU (PX5N/TX5N)**

AMD-K5/K6	External Clock	Internal Clock	External Clock Factor			Reserve		External Clock Frequency					
			DS1	DS2	DS3	DS4	DS5	Normal			Turbo		
								DS6	DS7	DS8	DS6	DS7	DS8
K5-PR75	50MHz	75MHz	OFF	OFF	OFF	OFF	OFF	ON	ON	ON	---	---	---
K5-PR90	60MHz	90MHz	OFF	OFF	OFF	OFF	OFF	ON	ON	OFF	---	---	---
K5-PR100	66MHz	100MHz	OFF	OFF	OFF	OFF	OFF	ON	OFF	ON	OFF	OFF	OFF
K5-PR120	60MHz	90MHz	OFF	OFF	OFF	OFF	OFF	ON	ON	OFF	---	---	---
K5-PR133	66MHz	100MHz	ON	OFF	OFF	OFF	OFF	ON	OFF	ON	OFF	OFF	OFF
K5-PR150	60MHz	120MHz	ON	ON	OFF	OFF	OFF	ON	ON	OFF	---	---	---
K5-PR166	66MHz	133MHz	ON	ON	OFF	OFF	OFF	ON	OFF	ON	OFF	OFF	OFF
K6-166	66MHz	166MHz	ON	ON	OFF	OFF	OFF	ON	OFF	ON	OFF	OFF	OFF
K6-200	66MHz	200MHz	OFF	ON	OFF	OFF	OFF	ON	OFF	ON	OFF	OFF	OFF
K6-233	66MHz	233MHz	OFF	OFF	OFF	OFF	OFF	ON	OFF	ON	OFF	OFF	OFF
K6-266	66MHz	266MHz	ON	OFF	ON	OFF	OFF	ON	OFF	ON	OFF	OFF	OFF
K6-300	66MHz	300MHz	ON	ON	ON	OFF	OFF	ON	OFF	ON	OFF	OFF	OFF

**Cyrix/IBM 6x86/6x86L CPU (PX5N/TX5N)**

Cyrix/IBM 6x86/6x86L	External Clock	Internal Clock	External Clock Factor					Reserve		External Clock Frequency					
			DS1	DS2	DS3	DS4	DS5	Normal			Turbo				
								DS6	DS7	DS8	DS6	DS7	DS8		
PR120+	50MHz	100MHz	ON	OFF	OFF	OFF	OFF	ON	ON	ON	---	---	---		
PR133+	55MHz	110MHz	ON	OFF	OFF	OFF	OFF	OFF	ON	ON	---	---	---		
PR150+	60MHz	120MHz	ON	OFF	OFF	OFF	OFF	ON	ON	OFF	---	---	---		
PR166+	66MHz	133MHz	ON	OFF	OFF	OFF	OFF	ON	OFF	ON	OFF	OFF	OFF		
PR200+	75MHz	150MHz	ON	OFF	OFF	OFF	OFF	OFF	ON	OFF	---	---	---		
<b>6x86MX</b>															
PR150	66MHz	133MHz	ON	OFF	OFF	OFF	OFF	ON	OFF	ON	OFF	OFF	OFF		
PR166	60MHz	150MHz	ON	ON	OFF	OFF	OFF	ON	ON	OFF	---	---	---		
PR200	66MHz	166MHz	ON	ON	OFF	OFF	OFF	ON	OFF	ON	OFF	OFF	OFF		
PR233	66MHz	200MHz	OFF	ON	OFF	OFF	OFF	ON	OFF	ON	OFF	OFF	OFF		
PR266	66MHz	233MHz	OFF	OFF	OFF	OFF	OFF	ON	OFF	ON	OFF	OFF	OFF		
PR200	75MHz	150MHz	ON	OFF	OFF	OFF	OFF	OFF	ON	OFF	---	---	---		
PR233	75MHz	188MHz	ON	ON	OFF	OFF	OFF	OFF	ON	OFF	---	---	---		
PR233	83MHz	166MHz	ON	OFF	OFF	OFF	OFF	OFF	OFF	ON	---	---	---		

The turbo mode can be set when the CPU external clock can support. The turbo mode will increase the external clock by about 2.5%. It is used to verify the frequency tolerance at the design phase. It is very important for the designer to conduct some tests. Please do not setup the turbo mode during normal operation if you are not familiar with CPU architecture .

There are eight switches at SW1, DS1-DS3 are used to setup the rating parameter and DS6-DS8 are used to setup the external clock. The following tables present all of the adjustments for the setup combinations of CPU.

2.CPU Voltage and Setup (SW2)

For the voltage of the 586 series CPU, there are two kinds of operation modes depending on the different CPUs; single voltage and dual voltage. Please make sure which kind of CPU and the working voltage that you use before installation. The following table presents all of the adjustments of voltage for all of the 586 series CPUs, Please setup the Vcore voltage if the CPU you are using is single voltage.

SW2 CPU Vcore / Vio settings

VCORE						VIO		
Vcore/Vio	VC1	VC2	VC3	VC4	VC5	VC6	VC7	VC8
3.5/3.3	ON	ON	ON	ON	OFF	OFF	ON	OFF
3.4/3.3	OFF	ON	ON	ON	OFF	OFF	ON	OFF
3.3/3.3	ON	OFF	ON	ON	OFF	OFF	ON	OFF
3.2/3.38	OFF	OFF	ON	ON	OFF	OFF	OFF	ON
2.9/3.38	ON	OFF	OFF	ON	OFF	OFF	OFF	ON
2.8/3.38	OFF	OFF	OFF	ON	OFF	OFF	OFF	ON
2.7/3.38	ON	ON	ON	OFF	OFF	OFF	OFF	ON
2.6/3.38	OFF	ON	ON	OFF	OFF	OFF	OFF	ON
2.5/3.38	ON	OFF	ON	OFF	OFF	OFF	OFF	ON
2.4/3.38	OFF	OFF	ON	OFF	OFF	OFF	OFF	ON
2.3/3.38	ON	ON	OFF	OFF	OFF	OFF	OFF	ON
2.2/3.38	OFF	ON	OFF	OFF	OFF	OFF	OFF	ON
2.1/3.38	ON	OFF	OFF	OFF	OFF	OFF	OFF	ON
2.0/3.38	OFF	OFF	OFF	OFF	OFF	OFF	OFF	ON

**Note** The Vcore of CPU voltage is designed using a switching power supply, the Vio of CPU voltage is designed using a linear regulator power supply. That means Vcore can provide more current and voltage drop without creating more heat and high temperatures. The linear power supply will create more heat and higher temperatures. Please setup the Vio voltage less than Vcore voltage if the single voltage CPU is installed, it is used to make sure the CPU voltage is provided by Vcore (Switching Power Supply), and make the CPU more stable.



The following tables present adjustments of SW2 for Vcore and Vio of CPUs, all the voltage combinations of the switch setup are reserved for current and future CPUs.

**SW2 Vcore settings**

Nominal Output Voltage DACOUT	Pin Name SW2					Nominal Output Voltage DACOUT	Pin Name SW2				
	VC1	VC2	VC3	VC4	VC5		VC1	VC2	VC3	VC4	VC5
1.30	OFF	OFF	OFF	OFF	ON	2.0	OFF	OFF	OFF	OFF	OFF
1.35	ON	OFF	OFF	OFF	ON	2.1	ON	OFF	OFF	OFF	OFF
1.40	OFF	ON	OFF	OFF	ON	2.2	OFF	ON	OFF	OFF	OFF
1.45	ON	ON	OFF	OFF	ON	2.3	ON	ON	OFF	OFF	OFF
1.50	OFF	OFF	ON	OFF	ON	2.4	OFF	OFF	ON	OFF	OFF
1.55	ON	OFF	ON	OFF	ON	2.5	ON	OFF	ON	OFF	OFF
1.60	OFF	ON	ON	OFF	ON	2.6	OFF	ON	ON	OFF	OFF
1.65	ON	ON	ON	OFF	ON	2.7	ON	ON	ON	OFF	OFF
1.70	OFF	OFF	OFF	ON	ON	2.8	OFF	OFF	OFF	ON	OFF
1.75	ON	OFF	OFF	ON	ON	2.9	ON	OFF	OFF	ON	OFF
1.80	OFF	ON	OFF	ON	ON	3.0	OFF	ON	OFF	ON	OFF
1.85	ON	ON	OFF	ON	ON	3.1	ON	ON	OFF	ON	OFF
1.90	OFF	OFF	ON	ON	ON	3.2	OFF	OFF	ON	ON	OFF
1.95	ON	OFF	ON	ON	ON	3.3	ON	OFF	ON	ON	OFF
2.00	OFF	ON	ON	ON	ON	3.4	OFF	ON	ON	ON	OFF
2.05	ON	ON	ON	ON	ON	3.5	ON	ON	ON	ON	OFF

**SW2 Vio settings**

Nominal Output Voltage DACOUT	V I/O		
	VC6	VC7	VC8
3.1	ON	OFF	OFF
3.3	OFF	ON	OFF
3.38	OFF	OFF	ON
3.52	OFF	OFF	OFF

## ⑤ Installing System Memory ; i DRAM Memory ; j

---

When this mainboard was designed, we not only took into account present needs, but we also tried to address demands for future upgrades:

1. 168-pin DIMM sockets:
  - ❶ PX5N/TX5N support two 168 pin DIMM sockets  
If you want to extend your memory capacity, you will have no choice but to use the 168-pin 3.3V unbuffered DIMM sockets.
2. 72-pin SIMM sockets:
  - ❶ TX5N support four 72 pin SIMM sockets
  - ❷ PX5N support two 72 pin SIMM sockets
3. Easy installation  
You just need to insert the modules, without the help of God. Isn't it great?

Besides the features mentioned above, you can simultaneously use 72-pin SIMM modules and 168-pin DIMM modules, but you will rarely encounter this kind of configuration. Before you proceed with installation, be patient, first read what follows:

### 1. **Factory default setting of the mainboard is for 60ns FP or EDO modules.**

If your memory modules are faster than 60ns, say 45ns, you can modify the BIOS settings in order to speed up the operating speed of the system. But if you don't want to modify these settings, or if you don't know how to modify them, it's no big deal.

But if you set the external CPU clock at 66MHz or more, we recommend you use 60ns or even faster DRAM modules.

### 2. **Memory error check and correction do not support this feature on this mainboard.**

Since the Intel 430TX chipset does not support this feature and since the memory error check and correction feature may not be effective, *and* since you cannot easily find memory modules with memory check and correction features, this mainboard does not support it.

**3. Maximum memory capacity 256M bytes supported by this mainboard.**

**Computer knowledge ; i Relationships between memory modules and Pentium CPUs ; j**

Pentium P54C, P55C, Cyrix 6x86 . 6x86L . 6x86MX and AMD-K5/K6 are all 64 bit CPUs, but 72-pin SIMM modules are only 32-bit. That’s why they have to be used in pairs, because the CPU will always be only able to see 64 bits. This means that 72-pin SIMM modules have to be installed in pairs. For instance, SIMM1 and SIMM2 must form a pair, and SIMM3 and SIMM4 must form another pair. Of course, the two members of a pair must be of the same kind ; i EDO or FP DRAM ; j , and you cannot use pairs from different “species”. But the TX5N support different “pairs” and use different type of memory modules, notice:

- ; i SIMM1 and SIMM2 ; j must use the same memory type, as well as ; i SIMM3 and SIMM4 ; j .
- ; i SIMM1 and SIMM2 ; j use the same memory type, and ; i SIMM3 and SIMM4 ; j can use the same type, or a different type, in order to permit you to obtain the best speed configuration for each “single” pair, and to make the system work at its maximum capacity. If one memory pair is slower, it will have no influence on the pair whose speed is higher.

168-pin DIMM modules are 64 bit, so you can use single modules. On the AX5N/PX5N/TX5N mainboard, these modules can support not only EDO and FP DRAM, but also Synchronous DRAM memory configurations.

When you install DIMM modules on the mainboard, you don’t have to setup anything, just be sure that you use 3.3V unbuffered 168-pin DIMM modules, and insert them in the memory socket.

**Computer Knowledge****; i 168-pin DIMM modules specifications ; j**

According to the standards defined by JEDEC, there are a lot of different types of specifications for 168-pin DIMM sockets. Here are the possible types:

- 3.3V UNBUFFERED DIMM
- 3.3V BUFFERED DIMM
- 5V UNBUFFERED DIMM
- 5V BUFFERED DIMM

These types of DIMM modules differ not only by the electrical design, but also by their architecture. So, if you buy different types of DIMM modules, you will not be able to insert them in the DIMM sockets. Currently, the standard for PC is 3.3V UNBUFFERED DIMM, which is the standard supported by this series.

After installing the DRAM, the BIOS of the mainboard will automatically detect the size of the memory installed on the mainboard. Below is a list of all the possible situations:

Scenario 1: You only use 72-pin SIMM modules:

- The maximum memory size is 256M bytes.
- Support possible for single density or double density memory modules.
- Memory modules supported: 1Mx32 ; i 4M ; j , 2Mx32 ; i 8M ; j 4Mx32 ; i 16M ; j 8Mx32 ; i 32M ; j or 16Mx32 ; i 64M ; j .
- You can also directly refer to table 2-1.

Scenario 2: You only use 168-pin DIMM modules:

- The maximum memory size is 256M bytes.
- Support possible for single density or double density memory modules.
- Memory modules supported: 1Mx64 ; i 8M ; j , 2Mx64 ; i 16M ; j 4Mx64 ; i 32M ; j 8Mx64 ; i 64M ; j or 16Mx64 ; i 128M ; j .
- DIMM1 is the first pair, DIMM2 is the second pair. Usually, you first insert modules in DIMM1 socket, than in DIMM2 socket, but it is possible to do the reverse.

- You can also directly refer to table 2-2.

Scenario 3: You use 72-pin SIMM modules and 168-pin DIMM modules:

- The maximum memory size is: 256M bytes.
- Support possible for single density or double density memory modules.
- Memory modules supported: Refer to case 1 and case 2 above.
- Support possible for mixed use of single density and double density modules.
- Since there are a lot of possible configurations, no table is given.

System DRAM	PX5N	TX5N
72- pin SIMM socket	2 SIMMs	4 SIMM
Support FP DRAM	Yes	Yes
Support EDO DRAM	Yes	Yes
168-pin DIMM specifications	3.3V Unbuffered	3.3V Unbuffered
168-pin DIMM socket	2 DIMMs	2 DIMMs
Support FP DRAM	Yes	Yes
Support EDO DRAM	Yes	Yes
Support synchronous DRAM (SDRAM)	Yes	Yes
DRAM Error Check	No	No
Maximum memory size	256MB	256MB

**Table 2-1** 72-pin SIMM Module Installation

i i SIMM1, SIMM2 i j 1 <sup>st</sup> i i 2 <sup>nd</sup> pair i j	i i SIMM3, SIMM4 i j * 2 <sup>nd</sup> i i 1 <sup>st</sup> pair i j	Total memory size
NO MODULE INSERTED	1Mx32 i i 4Mx2 i j	8MB
	2Mx32 i i 8Mx2 i j	16MB
	4Mx32 i i 16Mx2 i j	32MB
	8Mx32 i i 32Mx2 i j	64MB
	16Mx32 i i 64Mx2 i j	128MB
1Mx32 i i 4Mx2 i j	NO MODULE INSERTED	8MB
2Mx32 i i 8Mx2 i j		16MB
4Mx32 i i 16Mx2 i j		32MB
8Mx32 i i 32Mx2 i j		64MB
16Mx32 i i 64Mx2 i j		128MB
Since the installation described above is valid for the first pair as well as for the second pair, it will not be repeated.		
1Mx32 i i 4Mx2 i j	1Mx32 i i 4Mx2 i j	16MB
	2Mx32 i i 8Mx2 i j	24MB
	4Mx32 i i 16Mx2 i j	40MB
	8Mx32 i i 32Mx2 i j	72MB
	16Mx32 i i 64Mx2 i j	136MB
2Mx32 i i 8Mx2 i j	1Mx32 i i 4Mx2 i j	24MB
	2Mx32 i i 8Mx2 i j	32MB
	4Mx32 i i 16Mx2 i j	48MB
	8Mx32 i i 32Mx2 i j	80MB
	16Mx32 i i 64Mx2 i j	144MB
4Mx32 i i 16Mx2 i j	1Mx32 i i 4Mx2 i j	40MB
	2Mx32 i i 8Mx2 i j	48MB
	4Mx32 i i 16Mx2 i j	64MB
	8Mx32 i i 32Mx2 i j	96MB
	16Mx32 i i 64Mx2 i j	160MB
8Mx32 i i 32Mx2 i j	1Mx32 i i 4Mx2 i j	72MB
	2Mx32 i i 8Mx2 i j	80MB
	4Mx32 i i 16Mx2 i j	96MB
	8Mx32 i i 32Mx2 i j	128MB
	16Mx32 i i 64Mx2 i j	192MB
16Mx32 i i 64Mx2 i j	1Mx32 i i 4Mx2 i j	136MB
	2Mx32 i i 8Mx2 i j	144MB
	4Mx32 i i 16Mx2 i j	160MB
	8Mx32 i i 32Mx2 i j	192MB
	16Mx32 i i 64Mx2 i j	256MB

\*: indicates that only TX5N supports this configuration

Perhaps you have already found out the rules from the table above. This table, we believe, contains all possible configurations. In fact, you just need to insert two or four 72-pin SIMM modules in the socket to complete the installation.

**Table 2-2** 168-pin DIMM Module Installation

i i DIMM1 i j	i i DIMM2 i j	i i DIMM3 i j	Total memory size
1 <sup>st</sup> i i 2 <sup>nd</sup> or 3 <sup>rd</sup> i j pair	2 <sup>nd</sup> i i 1 <sup>st</sup> or 3 <sup>rd</sup> i j pair	3 <sup>rd</sup> i i 1 <sup>st</sup> or 2 <sup>nd</sup> i j pair	
NO MODULE INSERTED	NO MODULE INSERTED	1Mx64 i i 8M i j	8MB
		2Mx64 i i 16M i j	16MB
		4Mx64 i i 32M i j	32MB
		8Mx64 i i 64M i j	64MB
		16Mx64 * <sup>1</sup> i i 128M i j	128MB* <sup>1</sup>
NO MODULE INSERTED	1Mx64 i i 8M i j	NO MODULE INSERTED	8MB
	2Mx64 i i 16M i j		16MB
	4Mx64 i i 32M i j		32MB
	8Mx64 i i 64M i j		64MB
	16Mx64 i i 128M i j		128MB
1Mx64 i i 8M i j	NO MODULE INSERTED	NO MODULE INSERTED	8MB
2Mx64 i i 16M i j			16MB
4Mx64 i i 32M i j			32MB
8Mx64 i i 64M i j			64MB
16Mx64 i i 128M i j			128MB
Since the installation described above is valid for the first pair as well as for the second pair, it will not be repeated.			
1Mx64 i i 8M i j	1Mx64 i i 8M i j	NO MODULE INSERTED	16MB
	2Mx64 i i 16M i j		24MB
	4Mx64 i i 32M i j		40MB
	8Mx64 i i 64M i j		72MB
	16Mx64 i i 128M i j		136MB
1Mx64 i i 8M i j	NO MODULE INSERTED	1Mx64 i i 8M i j	16MB
		2Mx64 i i 16M i j	24MB
		4Mx64 i i 32M i j	40MB
		8Mx64 i i 64M i j	72MB
		16Mx64 * <sup>1</sup> i i 128M i j	136MB* <sup>1</sup>
1Mx64 i i 8M i j	1Mx64 i i 8M i j	1Mx64 i i 8M i j	24MB
	2Mx64 i i 16M i j	2Mx64 i i 16M i j	40MB
	4Mx64 i i 32M i j	4Mx64 i i 32M i j	72MB
	8Mx64 i i 64M i j	8Mx64 i i 64M i j	136MB
	16Mx64 i i 128M i j	16Mx64 * <sup>1</sup> i i 128M i j	256MB* <sup>1</sup> * <sup>2</sup>
2Mx64 i i 16M i j	1Mx64 i i 8M i j	NO MODULE	24MB
	2Mx64 i i 16M i j		32MB
	4Mx64 i i 32M i j		48MB



8Mx64 i i 64M i j	INSERTED	80MB
16Mx64 i i 128M i j		144MB

i i DIMM1 j j	i i DIMM2 j j	i i DIMM3 j j	Total memory size
1 <sup>st</sup> j i 2 <sup>nd</sup> or 3 <sup>rd</sup> j j pair	2 <sup>nd</sup> j i 1 <sup>st</sup> or 3 <sup>rd</sup> j j pair	3 <sup>rd</sup> j i 1 <sup>st</sup> or 2 <sup>nd</sup> j j pair	
2Mx64 j i 16M j j	NO MODULE INSERTED	1Mx64 j i 8M j j	24MB
		2Mx64 j i 16M j j	32MB
		4Mx64 j i 32M j j	48MB
		8Mx64 j i 64M j j	80MB
		16Mx64 * <sup>1</sup> j i 128M j j	144MB* <sup>1</sup>
2Mx64 j i 16M j j	1Mx64 j i 8M j j	1Mx64 j i 8M j j	32MB
	2Mx64 j i 16M j j	2Mx64 j i 16M j j	48MB
	4Mx64 j i 32M j j	4Mx64 j i 32M j j	80MB
	8Mx64 j i 64M j j	8Mx64 j i 64M j j	144MB
	16Mx64 j i 128M j j	16Mx64 * <sup>1</sup> j i 128M j j	256MB* <sup>1</sup> * <sup>2</sup>
4Mx64 j i 32M j j	NO MODULE INSERTED	1Mx64 j i 8M j j	40MB
		2Mx64 j i 16M j j	48MB
		4Mx64 j i 32M j j	64MB
		8Mx64 j i 64M j j	96MB
		16Mx64 j i 128M j j	160MB
4Mx64 j i 32M j j	NO MODULE INSERTED	1Mx64 j i 8M j j	40MB
		2Mx64 j i 16M j j	48MB
		4Mx64 j i 32M j j	64MB
		8Mx64 j i 64M j j	96MB
		16Mx64 * <sup>1</sup> j i 128M j j	160MB* <sup>1</sup>
4Mx64 j i 32M j j	1Mx64 j i 8M j j	1Mx64 j i 8M j j	48MB
	2Mx64 j i 16M j j	2Mx64 j i 16M j j	64MB
	4Mx64 j i 32M j j	4Mx64 j i 32M j j	96MB
	8Mx64 j i 64M j j	8Mx64 j i 64M j j	160MB
	16Mx64 j i 128M j j	16Mx64 * <sup>1</sup> j i 128M j j	256MB* <sup>1</sup> * <sup>2</sup>
8Mx64 j i 64M j j	NO MODULE INSERTED	1Mx64 j i 8M j j	72MB
		2Mx64 j i 16M j j	80MB
		4Mx64 j i 32M j j	96MB
		8Mx64 j i 64M j j	128MB
		16Mx64 j i 128M j j	192MB
8Mx64 j i 64M j j	NO MODULE INSERTED	1Mx64 j i 8M j j	72MB
		2Mx64 j i 16M j j	80MB
		4Mx64 j i 32M j j	96MB
		8Mx64 j i 64M j j	128MB

		16Mx64 * <sup>1</sup> i i 128M i j	192MB* <sup>1</sup>
8Mx64 i i 64M i j	1Mx64 i i 8M i j	1Mx64 i i 8M i j	80MB
	2Mx64 i i 16M i j	2Mx64 i i 16M i j	96MB
	4Mx64 i i 32M i j	4Mx64 i i 32M i j	128MB
	8Mx64 i i 64M i j	8Mx64 i i 64M i j	192MB
	16Mx64 i i 128M i j	16Mx64 * <sup>1</sup> i i 128M i j	256MB* <sup>1</sup> * <sup>2</sup>

i i DIMM1 i j	i i DIMM2 i j	i i DIMM3 i j	Total memory size
1 <sup>st</sup> i i 2 <sup>nd</sup> or 3 <sup>rd</sup> i j pair	2 <sup>nd</sup> i i 1 <sup>st</sup> or 3 <sup>rd</sup> i j pair	3 <sup>rd</sup> i i 1 <sup>st</sup> or 2 <sup>nd</sup> i j pair	
16Mx64 i i 128M i j	1Mx64 i i 8M i j	NO MODULE INSERTED	136MB
	2Mx64 i i 16M i j		144MB
	4Mx64 i i 32M i j		160MB
	8Mx64 i i 64M i j		192MB
	16Mx64 i i 128M i j		256MB* <sup>1</sup> * <sup>2</sup>
16Mx64 i i 128M i j	NO MODULE INSERTED	1Mx64 i i 8M i j	136MB
		2Mx64 i i 16M i j	144MB
		4Mx64 i i 32M i j	160MB
		8Mx64 i i 64M i j	192MB
		16Mx64 * <sup>1</sup> i i 128M i j	256MB* <sup>1</sup> * <sup>2</sup>
16Mx64 i i 128M i j	1Mx64 i i 8M i j	1Mx64 i i 8M i j	144MB
	2Mx64 i i 16M i j	2Mx64 i i 16M i j	160MB
	4Mx64 i i 32M i j	4Mx64 i i 32M i j	192MB
	8Mx64 i i 64M i j	8Mx64 i i 64M i j	256MB
	16Mx64 i i 128M i j	16Mx64 * <sup>1</sup> i i 128M i j	256MB* <sup>1</sup> * <sup>2</sup>

**Computer Knowledge** Support FP or EDO DRAM only  
 Know the maximum capacity of memory

In fact, the table above shows that you just need to insert the DIMM module in any of the two sockets to complete the installation of the memory.

The voltage for the 72pin SIMM is +5V, and the 168pin DIMM is +3V, according the specification, it is strongly recommend not to mix both kinds of memory modules. It may cause the total amount of memory size to be different from the memory that is plugged-in when installed if you mix both kinds of

memory module. It may be because of one of the following reasons :

1. The DRAM's specification is different, cannot be mixed.
2. The DIMM and SIMM use the same RAS signal, and this may limit what is provided by the chipset design.





## Chapter 3 Introduction to BIOS

---

The BIOS is a program located on a Read-Only Memory chip on the mainboard. This program will not be lost when you turn the computer off. This program is also referred to as the boot program. It is the only channel for the hardware circuit to communicate with the operating system. Its main function is to manage the setup of the mainboard and interface card parameters, including simple parameters such as time, date, hard disk drive, as well as more complex parameters such as hardware synchronization, device operating mode, **CPU SOFT MENU™** techniques, setup of CPU voltage and speed. The computer will operate normally, or will operate at its best, only if all these parameters are correctly configured through the BIOS.

 **Don't change the parameters inside the BIOS unless you know what you are doing**

The parameters inside the BIOS are used to setup the hardware synchronization or the device operating mode. If the parameters are not correct, they will produce errors, the computer will crash, and sometimes you will even not be able to boot the computer after it has crashed. We recommend you do not change the parameters inside the BIOS unless you are familiar with them. If you are not able to boot your computer anymore, please refer to the section "Erase CMOS data" in Chapter 2.

When you start the computer, it is controlled by the BIOS program. The BIOS first operates an auto-diagnostic for all the necessary hardware, configures the parameters of the hardware synchronization, and detects all the hardware. Only when these tasks are complete does it give up control of the computer to the program of the next level, which is the operating system. Since the BIOS is the only channel for hardware and software to communicate, it is a key factor in system stability and ensuring your system performs at its best. After the BIOS has completed the auto-diagnostic and auto-detection operations, it will display the following message:

**PRESS DEL TO ENTER SETUP**

Three to five seconds after the message is displayed, if you press the **Del** key, or if you press the **Ctrl Alt Esc** keys simultaneously, you will access the BIOS Setup menu. At that moment, the BIOS will display the following message:



Fig 3 BIOS Setup main menu

In the BIOS Setup main menu of Figure 3, you can see several options. We will explain these options step by step in the following pages, but let us first look at a short description of the function keys you may use here:

- Press **Esc** to quit the BIOS Setup.
- Press **↑ ↓ → ←** (up, down, left, right) to choose the option you want to confirm or to modify in the main menu.
- Press **F10** when you have completed the setup of BIOS parameters to save these parameters and exit the BIOS Setup menu.
- Press Page Up/Page Down or +/- keys when you want to modify the BIOS parameters for the active option.



**Computer  
knowledge**

**CMOS DATA**

Maybe you have heard somebody saying that their CMOS DATA was lost. What is the CMOS? Is it important? The CMOS is the memory used to store the BIOS parameters that you have configured. This memory is passive. You can read its data and you can also store data in it. But this memory has to be powered by a battery in order to avoid any loss of its data when the computer is turned off. Since you may have to change the CMOS battery when it is out of power and in doing so, you will lose all CMOS data, therefore, we recommend that you write down all the parameters of your hardware, or to put a label with these parameters on your hard disk.

## ① Standard CMOS Setup Menu

These are the basic configuration parameters of the BIOS. These parameters include the date, hour, VGA card, FDD and HDD settings.

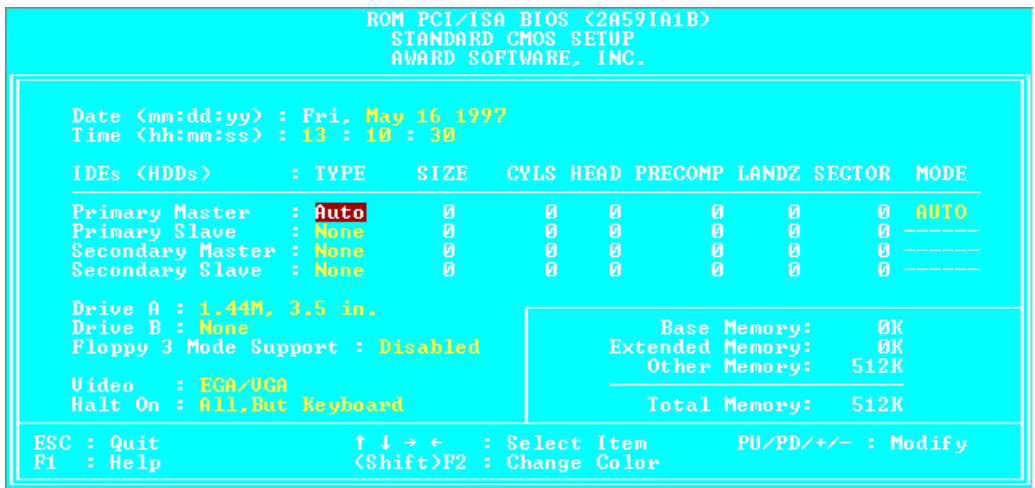

Fig 3-2 Standard CMOS Setup Menu

- *Set up of HDD operating mode* ; i NORMAL, LBA, LARGE ; j

Since old operating systems were only able to support HDDs with a capacity less than 528MB, any hard disk with more than 528MB was unusable. AWARD BIOS features a solution to this problem: you can, according to your operating system, choose three operating modes: NORMAL, LBA or LARGE.

➤ **Normal mode:**

Standard normal mode supports hard disks of 528MB or less. This mode directly uses positions indicated by Cylinders (CYLS), Heads, and Sectors to access data.

➤ **LBA (Logical Block Addressing)**

**mode:**

LBA mode supports hard disk drives up to 8.4Giga. This mode uses a different method to calculate the position of disk data to be accessed. It translates Cylinders (CYLS), Heads and Sectors into a logical address where data is located. The Cylinders, Heads, and Sectors displayed in this menu do not reflect the actual structure of the hard disk, they are just reference values used to calculate actual positions. Currently, all high capacity hard disks support this mode, that's why we recommend you use this mode. The HDD AUTODETECTION option in the Main Menu will automatically detect the parameters of your hard disk and the mode supported.

➤ **LARGE Mode:**

When the number of cylinders (CYLS) of the hard disk exceeds 1024 and DOS is not able to support it, or if your operating system does not support LBA mode, you should select this mode.

● ***FDD supporting 3 Mode:***

3 Mode floppy disk drives (FDD) are 3 1/2" drives used in Japanese computer systems. If you need to access data stored in this kind of floppy, you must select this mode, and of course you must have a 3 Mode floppy drive and a driver, and 3 Mode Device Driver .

📄 For further information about HDD installation, refer to Appendix E.

## ② BIOS Features Setup Menu

BIOS Features Setup Menu has already been set for maximum operation. If you do not really understand the options in this menu, we recommend you use default values.

In each item, you can press <F1> at any time to display all the options for this item.

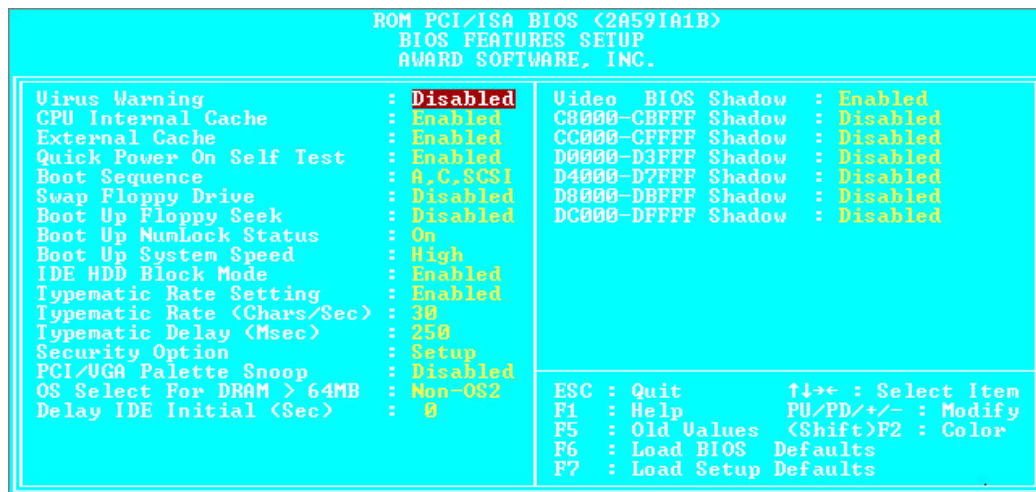

Fig 3-3 BIOS Features Setup

### ***Virus Warning:***

This item can be set as Enable or Disable.

When this feature is enabled, if there is any attempt from software or an application to access the boot sector or the partition table, the BIOS will warn you that a boot virus is attempting to access the hard disk.

### ***CPU Internal Cache:***

This item is used to Enable or to Disable the CPU internal cache. When the cache is set at Disable, it is much slower, so the default setting for this item is Enable. Some old and very bad programs will make the computer malfunction or crash if the system speed is too high. In that case, you should Disable this feature.

***CPU External Cache:***

This item is used to enable or to disable the CPU external cache. When the external cache is enabled, the system works faster. The default is Enable.

***Quick power on self test:***

After the computer has been turned on, the BIOS of the mainboard will run a series of tests in order to check the system and its peripherals. If the Quick power on self test feature is Enable, the BIOS will simplify the test procedures in order to speed up the boot process. The default is Enable.

***Boot Sequence:***

When the computer boots up, it can load the operating system from floppy drive A:, hard disk drive C:, SCSI disk drive or CD-ROM. There are many options for the boot sequence:

- A, C, SCSI
- C, A, SCSI
- C, CD-ROM, A
- CD-ROM, C, A
- D, A, SCSI (at least 2 IDE HDD can be used)
- E, A, SCSI (at least 3 IDE HDD can be used)
- F, A, SCSI (at least 4 IDE HDD can be used)
- SCSI, A, C
- SCSI, C, A
- A, SCSI, C
- LS120, C

***Swap Floppy Drive:***

This item can be set as Enable or Disable.

When this feature is enabled, you don't need to open the computer case to swap the position of floppy disk drive connectors. Drive A: can be set as drive B:, and drive B: can be set as drive A:.

***Boot Up Floppy Seek:***

When the computer boots up, the BIOS detects if the system has a FDD or not. When this item is enabled, if the BIOS does not detect a floppy drive, it will display a floppy disk drive error message. If this item is disabled, the BIOS will skip this test.

***Boot Up NumLock Status:***

- On: At boot up, the Numeric Keypad is in numeric mode.
- Off: At boot up, the Numeric Keypad is in cursor control mode.

***IDE HDD Block Mode:***

This item can be set as Enable or Disable.

Most new hard disk drives (IDE drives) support multi-sector transfers. This feature speeds up hard disk drive access performance and reduces the time necessary to access data. When this item is enabled, the BIOS will automatically detect if your hard disk drive supports this feature or not, and will choose the right settings for you.

📄 For further details about hard disk drive installation, refer to appendix E.

***Typematic Rate Setting:***

This item allows you to adjust the keystroke repeat rate. When enabled, you can set the two keyboard typematic controls that follow (Typematic Rate and Typematic Rate Delay). If this item is disabled, the BIOS will use the default setting.

***Typematic Rate (Chars/Sec):***

When you press a key continuously, the keyboard will repeat the keystroke according to the rate you have set. (Unit: characters/second ; ^

***Typematic Rate Delay (Msec):***

When you press a key continuously, if you exceed the delay you have set here, the keyboard will automatically repeat the keystroke according to a certain rate. (Unit: milliseconds)

***Security Option:***

This option can be set to System or to Setup.

After you have created a password through PASSWORD SETTING, this option will deny access to your system (System) or modification of the computer setup (BIOS Setup) by unauthorized users.

- **SYSTEM:** When you choose System, a password is required each time the computer boots up. If the correct password is not given, the system will not start.
- **SETUP:** When you choose Setup, a password is required only when accessing the BIOS Setup. If you have not set a password in the PASSWORD SETTING option, this option is not available.

**Notice:** Don't forget your password. If you forget the password, you will have to open the computer case and clear all information in the CMOS before you can start up the system. But doing this, you have to reset all the options you had set up before.

***PCI /VGA Palette Snoop:***

This option allows the BIOS to preview VGA Status, and to modify the information delivered from the Feature Connector of the VGA card to the MPEG Card. This option can solve the display inversion to black after you have used the MPEG card.

***Delay IDE Initial:***

This item is used for supporting some older models or special types of hard disks or CDRoms, since the BIOS may not detect those kinds of devices during system booting .

***OS Select For DRAM > 64MB:***

When the system memory is larger than 64MB, the communication method between the BIOS and the operating system will differ from one operating system to another. If you use OS/2, select OS2; if you choose another operating system, select Non-OS2.

***Video BIOS Shadow:***

This option is used to define whether the BIOS on the video card uses shadow feature or not. You should set this option to Enable, otherwise the display performance of the system will be greatly decreased.

***Shadowing address ranges (C8000-CBFFF Shadow):***

This option allows you to decide if the memory block (BIOS) of an interface card at the address C8000-CBFFF uses the shadow feature or not. If you do not have an interface card using this memory block, don't enable this option.

***Shadowing address ranges (CC000-CFFFF Shadow):***

This option allows you to decide if the memory block (BIOS) of an interface card at the address CC000-CFFFF uses the shadow feature or not. If you do not have an interface card using this memory block, don't enable this option.

***Shadowing address ranges (D0000-D3FFF Shadow):***

This option allows you to decide if the memory block (BIOS) of an interface card at the address D0000-D3FFF uses the shadow feature or not. If you do not have an interface card using this memory block, don't enable this option.

***Shadowing address ranges (D4000-D7FFF Shadow):***

This option allows you to decide if the memory block (BIOS) of an interface card at the address D4000-D7FFF uses the shadow feature or not. If you do not have an interface card using this memory block, don't enable this option.

***Shadowing address ranges (D8000-DBFFF Shadow):***

This option allows you to decide if the memory block (BIOS) of an interface card at the address D8000-DBFFF uses the shadow feature or not. If you do not have an interface card using this memory block, don't enable this option.

***Shadowing address ranges (DC000-DFFFF Shadow):***

This option allows you to decide if the memory block (BIOS) of an interface card at the address DC000-DFFFF uses the shadow feature or not. If you do not have an interface card using this memory block, don't enable this option.



**Computer  
knowledge**

**SHADOW**

What is a SHADOW? The BIOS of standard video or interface cards is stored in ROM, and it is often very slow. With the Shadow feature, the CPU reads the BIOS on the VGA card and copies it into RAM. When the CPU runs this BIOS, the operation is speeded up.

## ③ Chipset Features Setup Menu

The Chipset Features Setup Menu is used to modify the contents of the buffers in the chipset on the mainboard. Since the parameters of the buffers are closely related to hardware, if the setup is incorrect, the mainboard will become unstable or you will not be able to boot up. If you don't know the hardware very well, use default values (use the LOAD SETUP DEFAULTS option).

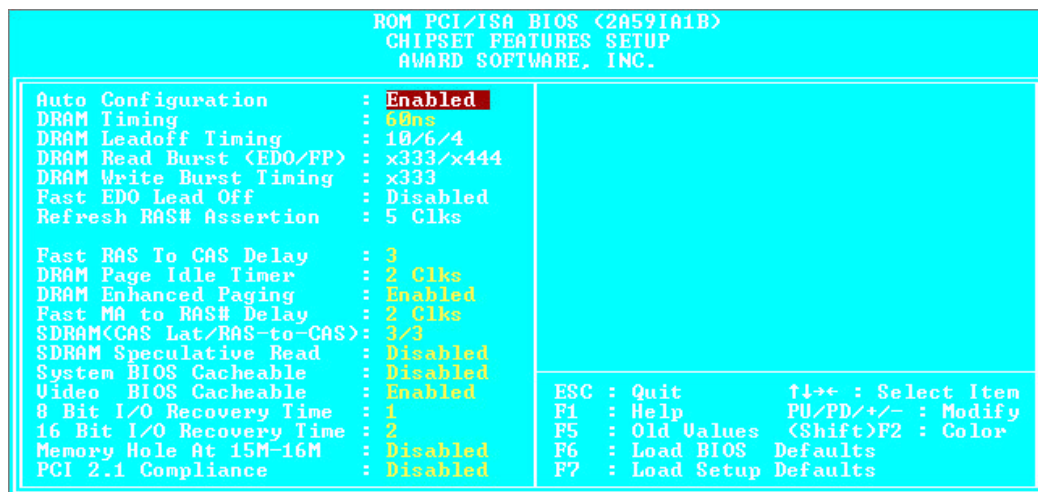

Fig 3-4 Chipset Features Setup

You can use the arrow keys to move between the items. Use "PgUP", "PgDn", "+" and "-" to change the values. When you have finished setting up the chipset, press "ESC" to go back to the main menu.

### **Auto Configuration:**

This option allows (Enable) or prevents (Disable) the BIOS from using default values for Auto Configuration. The BIOS default is Enable.

- When you select Enable, the BIOS will automatically use the values related to DRAM. You will not be able to set up the following options.
- When you select Disable, you can manually set up DRAM options.

**Attention:** Unless you are very familiar with your computer and with the DRAM configuration and speed, we recommend you do not change the DRAM options but enable this option.

***DRAM settings:***

The other DRAM settings are all closely related to hardware. If you do not understand this very well, don't make any changes. Our BIOS is able to autodetect the characteristics of your DRAM and to choose the best settings.

***Memory Hole At 15M-16M:***

This option is used to free up the 15M-16M memory block. Some special peripherals need to use a memory bloc located between 15M and 16M, and this memory block has a size of 1M. We recommend you disable this option.

There are small differences in the chipset feature setup according to different mainboard models, but this has no influence on performance. Our default is the optimal setup. That is why we do not describe all the features of this menu.

## ④ Power Management Setup Menu

The difference between Green PCs and traditional computers is that Green PCs have a power management feature. With this feature, when the computer is turned on but inactive, the power consumption is reduced in order to save energy. When the computer operates normally, it is in Normal mode. In this mode, the Power Management Program will control the access to video, parallel ports, serial ports and drives, and the operating status of the keyboard, mouse and other devices. These are referred to as Power Management Events. In cases where none of these events occur, the system enters the power saving mode. When one of the controlled events occurs, the system immediately returns to normal mode and operates at its maximum speed. Power saving modes can be divided into three modes according to their power consumption: Doze Mode, Standby Mode, and Suspend Mode. The four modes proceed in the following sequence:

Normal Mode====> Doze Mode====> Standby Mode====> Suspend Mode

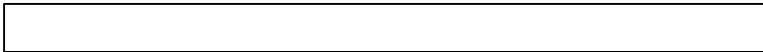

The system consumption is reduced according the following sequence:

Normal > Doze > Standby > Suspend

1. In the Main Menu, select "Power Management Setup" and press "Enter". The following screen is displayed:



Fig 3-5 Power Management Setup Menu

2. Use arrow keys to go to the item you want to configure. To change the settings, use "PgUP", "PgDn", "+" and "-".
3. After you have configured the Power Management feature, press "Esc" to go back to the Main Menu.

We are now going to briefly explain the options in this menu:

***Power Management:***

Four options:

➤ User Define

User Define defines the delay for accessing the power modes.

➤ Disable

Disable Power Management features.

➤ Min Saving

When the three saving modes are enabled, the system is set up for minimum power savings.

Doze = 1 hour

Standby = 1 hour

Suspend = 1 hour

➤ Max Saving

When the three saving modes are enabled, the system is set up for maximum power savings.

Doze = 1 minute

Standby = 1 minute

Suspend = 1 minute

***PM Control by APM:***

Power Management is completely controlled by the APM.

APM stands for Advanced Power Management, it is a power management standard set by Microsoft, Intel and other major manufacturers.

***Video Off Method:***

Three video off methods are available: "Blank", "V/H SYNC+Blank" and "DPMS". The default is "V/H SYNC+Blank".

If this setting does not shut off the screen, select "Blank". If your monitor and video card support DMPS standard, select "DPMS".

***Video Off After:***

Select the saving mode in which the video is switched off.

➤ Always On

The video will never be switched off in no saving mode.

➤ All Modes Off

The video will be switched off in all saving modes.

➤ Standby

The video will only be switched off in Standby or Suspend mode.

➤ Suspend

The video will only be switched off in Suspend mode.

***IDE HDD Power Down:***

If the system has not accessed data on the hard disk drive during the specified time period, the engine of the HDD will stop in order to save electricity.

You can set 1 to 15 minutes or select Disable according to your use of the HDD.

***Doze Mode:***

When the setting selected for "Power Management" is "User Define", you can set this mode for any delay from 1 minute to 1 hour. If no power management event occurs during this time period, meaning that computer is inactive during this period, the system will enter the **Doze** power saving mode.

If this mode is disabled, the system will enter the next mode in the sequence (Standby or Suspend mode).

***Standby Mode:***

When the setting selected for "Power Management" is "User Define", you can set this mode for any delay from 1 minute to 1 hour. If no power management event occurs during this time period, meaning the computer is inactive during this period, the system will enter the **Standby** power saving mode.

If this mode is disabled, the system will enter the next mode in the sequence (Suspend mode).

***Suspend Mode:***

When the setting selected for "Power Management" is "User Define", you can set this mode for any delay from 1 minute to 1 hour. If no power management event occurs during this time period, meaning the computer is inactive during this period, the system will enter the **Suspend** power saving mode. The CPU stops working completely.

If this mode is disabled, the system will not enter the Suspend mode.

***Throttle Duty Cycle:***

This is used to specify the CPU speed in saving mode. Seven options are available: 12.5%, 25.0%, 37.5%, 50.0%, 62.5%, 75.0% or 87.5%.

***CPU Fan Off In Suspend:***

CPU fan can be turn off in suspend mode.

***Power Button Override:***

Support ACPI Power Button Over-ride. The user presses the power button for more then four seconds while the system is in the working state, then the system will transition to the soft-off(Power off by software). This is called the power button over-ride.

***Break Event From Suspend:***

Support ACPI RTC Alarm Function (via IRQ8).

***Reload Global Timer Events***

When one of the specified occurs, the count down made for entry in power saving mode goes back to zero.

Since the computer will enter a power saving mode only after an inactivity delay specified (time specified for Doze, Standby and Suspend modes) and after it has no activity, during this time period, any event will cause the computer to re-count the time elapsed. Resume events are operations or signals that cause the computer to resume time counting.

***Resume by Ring:***

Special function supported by ATX power supply. To connect an external EODEM to the built-in serial port, the system will be turned on when the telephone rings.

## ⑤ PCI & Onboard I/O Setup

In this menu, you can change the INT# and IRQ of the PCI bus and the onboard I/O device, I/O port address and other hardware settings.

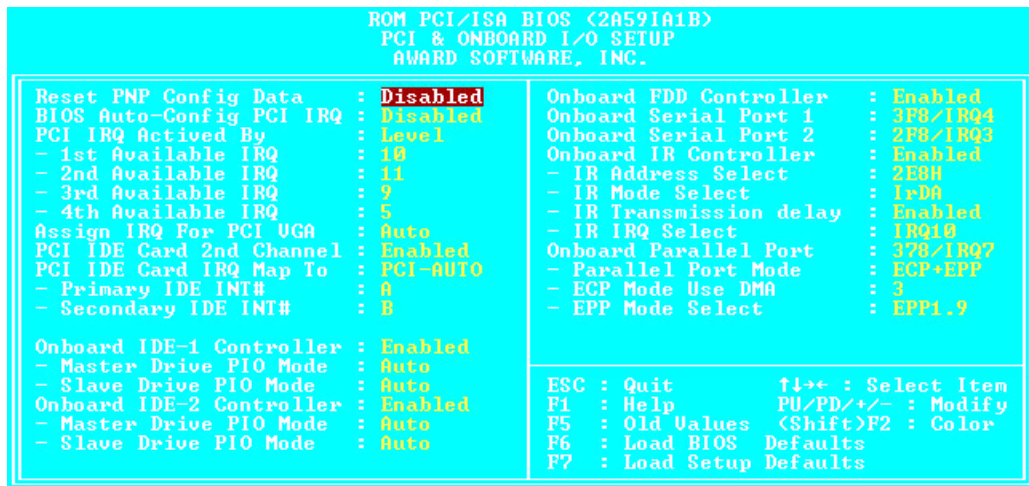

Fig 3-6 PCI & Onboard I/O Setup

### **Reset PnP Config Data:**

If you want to clear ESCD data next time you boot up, and ask the BIOS to reset the settings for the Plug & Play ISA Card and the PCI Card, select Enabled. But the next time you boot up, this option will automatically be set as Disabled.

### **Computer Knowledge**

#### **ESCD (Extended System Configuration Data)**

The ESCD contains the IRQ, DMA, I/O Port, Memory information of the system. This is a specification and a feature specific to Plug & Play BIOS.



***BIOS Auto-Config PCI IRQ:***

This option enables or disables the BIOS capability to automatically assign IRQs. The BIOS default is Disable.

When you select Enable, the BIOS will automatically assign the correct IRQ to the interrupt number (INT#) of the PCI slots. When this option is disabled, you have to assign IRQs used by the interrupt number (INT#) of the PCI slots.

***Xth Available IRQ:***

You can select four IRQs out of the 10 listed (IRQ3, 4, 5, 7, 9, 10, 11, 12, 14, 15) to be assigned for use by the interrupt number (INT#) of the PCI slot.

***1st Available IRQ:***

This means that the first interrupt number (INT#) found on the PCI bus will use this IRQ. That is, this IRQ will be assigned to the first interrupt number (INT#) found on the PCI bus.

***2nd Available IRQ:***

This means that the second interrupt number (INT#) found on the PCI bus will use this IRQ. That is, this IRQ will be assigned to the second interrupt number (INT#) found on the PCI bus.

***The third and the fourth available IRQ will be assigned in sequence to the third and the fourth interrupt numbers (INT#) found on the PCI bus.***

***PCI IDE Card 2nd Channel:***

This option can be enabled or disabled. BIOS default is Enable.

Since this channel uses IRQ15, if you want to use this channel, you have to enable this option to make the BIOS assign IRQ15 to this channel.

**PCI IDE Card IRQ Map to:**

Three options are available for this item: PCI Auto, PCI-slotX and ISA.

- PCI-Auto: The onboard BIOS auto-detects which PCI slot has an IDE card inserted in.
- PCI-slotX: Some old PCI IDE cards cannot be detected by the BIOS. If the onboard BIOS cannot detect a PCE IDE card, you have to specify on which PCI slot the IDE card is inserted, to make the BIOS assign IRQ14 for use by the interrupt number (INT#) of this PCI slot.
- ISA: If you select ISA, it means that your PCI IDE card features a “paddleboard” and a cable that can be connected to IRQ on the ISA slot, because the BIOS will not assign any IRQ to this PCI slot.

**Attention:** Primary Channel and Secondary Channel : The BIOS needs two independent interrupt number (INT#) lines to be allocated to the PCI IDE card. Be careful not to choose the same interrupt number twice (INT#).

**Note:** The interrupt signals of PCI slots were designed with the following connection rules. If the drivers or BIOS bundled with the PCI cards that you using (especially for some old model of PCI cards) don't conform to sharing IRQ signals, you should watch out this kind of situation.

- ☞ The INT#A signal of the first PCI slot, the INT#B signal of the second PCI slot, the INT#C signal of the third PCI slot and the INT#D signal of the fourth PCI slot, are the same, so be careful not to use them simultaneously.
- ☞ The INT#B signal of the first PCI slot, the INT#C signal of the second PCI slot, the INT#D signal of the third PCI slot and the INT#A signal of the fourth PCI slot, are the same, so be careful not to use them simultaneously.
- ☞ The INT#C signal of the first PCI slot, the INT#D signal of the second PCI slot, the INT#A signal of the third PCI slot and the INT#B signal of the fourth PCI slot, are the same, so be careful not to use them simultaneously.
- ☞ The INT#D signal of the first PCI slot, the INT#A signal of the second PCI slot, the INT#B signal of the third PCI slot and the INT#C signal of the fourth PCI slot, are the same, so be careful not to use them simultaneously.

***On Board FDD Controller:***

This is to Enable or Disable the Onboard FDD Controller.

***On board Serial Port 1:***

This is used to specify the I/O address and IRQ of Serial Port 1. Ten options are available: Disable, 3F8h/IRQ4, 2F8h/IRQ3, 3E8h/IRQ4 or 2E8h/IRQ3, 3F8/IRQ10, 2F8/IRQ11, AUTO, 3E8/IRQ10, 2E8/IRQ11.

***On board Serial Port 2:***

This is used to specify the I/O address and IRQ of Serial Port 2. Ten options are available: Disable, 3F8h/IRQ4, 2F8h/IRQ3, 3E8h/IRQ4 or 2E8h/IRQ3, 3F8/IRQ10, 2F8/IRQ11, AUTO, 3E8/IRQ10, 2E8/IRQ11.

***On board IR Controller:***

This is to Enable or Disable the Onboard IR Controller.

⇒ ***IR Address Select:***

This is used to specify the I/O address. Six options are available: 2F8H, 2E8H, 3F8H or 3E8H, 3E0H, 2E0H.

⇒ ***IR IRQ Select:***

This is used to specify the IRQ of IR. Four options are available: IRQ3,IRQ4,IRQ10 or IRQ11.

⇒ ***IR Transmission Delay:***

Set IR transmission delays 4 character-time(40 bit-time) when SIR is changed form RX mode to TX mode.

⇒ ***IR Mode Select:***

Four options are available:

- IrDA (HPSIR)mode.
- ASK IR (Amplitude Shift Keyed IR)mode.

***On board parallel Port:***

Set the I/O address and IRQ of the onboard parallel port. Four options are available: Disable, 3BCh/IRQ7, 278h/IRQ5 and 378h/IRQ7. Default is 378h/IRQ7.

⇒ ***Parallel Port Mode:***

Can be set as ECP, EPP, ECP+EPP, or Normal (SPP) mode. Default is Normal (SPP) mode.

⇒ ***ECP Mode Use DMA:***

When the mode selected for the onboard parallel port is ECP, the DMA channel selected can be Channel 1 or Channel 3.

⇒ ***EPP Mode Select:***

When the mode selected for the onboard parallel port is EPP, two EPP version options are available: EPP1.7 or EPP1.9 .

***On board IDE-1 Controller:***

Onboard PCI IDE 1 controller can be set as Enable or Disable.

⇒ ***Master drive PIO Mode:***

- Auto: the BIOS can auto-detect the PIO mode of the HDD in order to set its data transfer rate. (Default)
- Mode 0~Mode 4: User can specify the PIO mode of the HDD in order to set its data transfer rate.

⇒ ***Slave drive PIO Mode:***

- Auto: the BIOS can auto-detect the PIO mode of the HDD in order to set its data transfer rate. (Default)
- Mode 0~Mode 4: User can specify the PIO mode of the HDD in order to set its data transfer rate.

***On board IDE-2 Controller:***

The onboard IDE-2 controller can be set at Enable of Disable.

⇒ ***Master drive PIO Mode:***

- Auto: the BIOS can auto-detect the PIO mode of the HDD installed in order to set its data transfer rate. (Default)
- Mode 0~Mode 4: User can specify the PIO mode of the HDD in order to set its data transfer rate.

⇒ ***Slave drive PIO Mode:***

- Auto: the BIOS can auto-detect the PIO mode of the HDD installed in order to set its data transfer rate. (Default)
- Mode 0~Mode 4: User can specify the PIO mode of the HDD in order to set its data transfer rate.

**Computer  
knowledge**

MODE 0~4 reflects the HDD data transfer rate. The higher the MODE value is, the better is the HDD data transfer rate. But it does not mean that you can select the highest MODE value just as you like, you first have to be sure that your HDD supports this MODE, otherwise the hard disk will not be able to operate normally.

☰ For further information about HDD installation, refer to Appendix E.

## **⑥ Load BIOS Defaults**

---

BIOS defaults are the reference settings that allow your system to work at a comparatively low performance. When you choose the option, the following message is displayed:

“Load BIOS Defaults (Y/N)? N”

If you want to use BIOS default values, press “Y”, than <Enter>.

## **⑦ Load Setup Defaults**

---

Setup defaults are the settings that allow your system to operate at its highest performance. When you choose this option, the following message is displayed:

“Load Setup Defaults (Y/N)? N”

If you want to use BIOS Setup default values, press “Y”, than <Enter> to complete the loading of the settings for best performance.

You should first load the best settings, then enter the CPU Soft Menu to set up CPU parameters, otherwise the BIOS will replace set parameters by default parameters.

## ⑧ Password Setting

---

This option allows you to set a password required to start the system (System) or to access to the BIOS (Setup).

After you have set a password through the PASSWORD SETTING option, you can enter the Security Option in the “BIOS Features Setup Menu” to select the security level in order to prevent any unauthorized access.

### **Password setting procedure:**

When you choose the Password setting option, the following message is displayed:

**“Enter Password:“**

Type your password. When complete, press <Enter>. The following message is displayed:

**“Confirm Password:“**

Type your password again. When complete, press <Enter>. The password setting is completed.

### **Password clearing procedure:**

When you select the Password setting option, the following message is displayed:

**“Enter Password:“**

Press <Enter>, the message “Password Disable” is displayed. Press a key. The password clearing procedure is completed.

**Notice:** Do not forget your password. If you forget it, you will have to open the computer case, clear the contents of the CMOS, and boot the system up again. But doing this, you must reset all your settings.

## ⑨ IDE HDD Auto Detection

---

In old systems, after you had installed the hard disk, you had to know the hard disk specifications, such as the number of cylinders, heads and sectors, and enter the relevant information on to the hard disk information section. If the CMOS data was erased, and you had forgotten the hard disk specifications, problems ensued. But now, you can use this option to autodetect the hard disk type and specifications, and the BIOS will automatically detect all the relevant information and place them on the Hard Disk data section of the Standard CMOS Setup Menu, in order to allow you to use your hard disk.





# Appendix A Quick Installation

---

Appendix A will *give you a simplified installation procedure*, in order to allow you to install your mainboard quickly and correctly.

If you need further information or if you need to change some other settings, begin reading from Chapter 1.

### ***Installing the CPU:***

Lift up the lever of the CPU socket, insert your CPU into the socket, and lower the lever back in position. Don't worry, if you don't remember the correct orientation, you will not be able to insert the CPU if it is wrong.

### ***Adjusting CPU voltage and speed:***

Make sure the CPU parameters in the **CPU SOFT MENU™** of the BIOS SETUP according to your CPU voltage and speed. For information about your CPU, refer to appendices B, C or D, and to the information labeled on the CPU itself.

### ***Installing DRAM:***

**SIMM1 ~ SIMM2, DIMM1 ~ DIMM2 (PX5N)**

**SIMM1 ~ SIMM4, DIMM1 ~ DIMM2 (TX5N)**

Since Pentium are 64-bit CPUs, you have to use two 72-pin DRAM modules, or one 168-pin DRAM module. Install the module according the scenarios below:

- Scenario 1: Two identical 72-pin DRAM modules. Take the DRAM module and insert into the SIMM 1 and SIMM2 slots.
- Scenario 2: Four identical 72-pin DRAM modules. Take the DRAM module and insert into the SIMM 1, SIMM2, SIMM3 and SIMM4 slots.
- Scenario 3: If you have 4 DRAM modules, but only two are identical, insert the two identical modules into the SIMM1 and SIMM2 slots. Insert the other two modules into the SIMM3 and SIMM4 slots.

For other assembly, refer to Chapter Two, Installing System Memory.

***Installing FDD:***

**FDC-** Connect one end of the 34-pin cable that comes with the drive to the FDD connector, and the other end of the cable to the FDC pin connector on the mainboard.

**Note:** Be sure that the red line on the cable connects to the first pin of the connectors.

***Installing HDD:***

**IDE1-** Connect one end of the 40-pin cable that comes with the drive to the HDD connector, and the other end to IDE1 pin connector on the mainboard.

**Note:** Be sure that the red line on the cable connects to the first pin of the connectors.

***Installing CD-ROM Drive:***

**IDE2-** Connect one end of the 40-pin cable that comes with the drive to the CD-ROM connector, and the other end to the IDE2 pin connector on the mainboard.

**Note:** Be sure that the red line on the cable connects to the first pin of the connectors.

***Installing parallel port:***

**LPT-** Connect the 26-pin cable that comes with the hardware to the LPT connector on the mainboard.

***Installing serial port:***

**COM1-** Connect the 10-pin cable that comes with the hardware to connector COM1 on the mainboard.

**COM2-** Connect the other 10-pin cable to connector COM2 on the mainboard.

*Attach the bracket of Parallel Port, Serial Port and PS2 Mouse on the computer case.*

***Installing Keylock connector:***

*Watch the pin position and the orientation*

**PN1** - There is a specific orientation for pin 1 to pin 5. Insert the five-threads keylock cable into correct pins of connector on the mainboard.

Pin number	Name of the signal or signification	
1	+5VDC	POWER LED
2	No connection	POWER LED
3	Ground	POWER LED
4	Keyboard inhibit Signal	
5	Ground	

***Installing HDD LED connector:***

*Watch the pin position and the orientation*

**PN1** - There is a specific orientation for pin 7 and pin 8. Connect the two-threads IDE LED connector to the connector on mainboard.

Pin number	Name of the signal or signification
7	HDD LED signal <sub>i</sub> LED Cathode <sub>j</sub>
8	HDD LED signal <sub>i</sub> LED Anode <sub>j</sub>

***Installing SMI switch connector:***

*Watch the pin position and the orientation*

**PN1** - There is a specific orientation for pin 13 and pin 14. Connect the two-threads suspend switch connector of the computer case to correct pins of connector on the mainboard. You can ignore this connector since most of computer cases do not support this feature (the mainboard itself supports it).

Pin number	Name of the signal or signification
13	+VDD
14	Suspend

***Sleep LED connector:***

**PN2** - This connector has a specific orientation. Connect the two-threads Green LED connector on the mainboard.

Pin number	Name of the signal or signification
9	LED's Cathode
10	LED's Anode

***Installing speaker connector:***

**PN2** - There is no specific orientation for pin 4 to pin 7. Connect the four-threads speaker cable to the PN2 connector pins on the mainboard.

Pin number	Name of the signal or signification
4	+5VDC
5	Ground
6	Ground
7	Sound Signal

***Installing ATX Power input connector:***

*Watch the pin position and the orientation*

**ATXPWR** - Connect the power supply unit to the correct connectors on the mainboard.

Pin number	Name of the signal or signification	Pin number	Name of the signal or signification
1	+3.3VDC	11	+3.3VDC
2	+3.3VDC	12	-12VDC
3	Ground	13	Ground
4	+5VDC	14	PS_ON
5	Ground	15	Ground
6	+5VDC	16	Ground
7	Ground	17	Ground
8	POWERGOOD	18	-5VDC
9	+5VDC	19	+5VDC
10	+12VDC	20	+5VDC

***Installing Power input connector:***

*Watch the pin position and the orientation*

Connect connectors P8 and P9 (PX5N, TX5N) or the power supply unit to the correct connectors on the mainboard.

Pin number	Name of the signal or signification	Pin number	Name of the signal or signification
1	POWERGOOD	7	Ground
2	+5VDC	8	Ground
3	+12VDC	9	-5VDC
4	-12VDC	10	+5VDC
5	Ground	11	+5VDC
6	Ground	12	+5VDC

***Installing PS2 Mouse:***

**Mouse** - Connect the six-threads PS/2 Mouse cable that comes with the hardware to the connector on the mainboard. Install the bracket located on the other end of the computer case. When you buy a Mouse, it has to be a PS/2 Mouse for it to be connected to this port.

*Attach the bracket of Parallel Port, Serial Port and PS2 Mouse on the computer case.*

***Installing Keyboard connector:***

**KB1** - There is an orientation pin. Connect your keyboard connector to connector on the mainboard.

***Installing CPU Fan Power connector:***

**FAN1** - There is a specific orientation. Connect the three-threads CPU Fan power cable to the Fan connector on the mainboard.

PX5N FAN1	
Pin number	Name of the signal or signification
1	Ground
2	+12V
3	Ground

TX5N FAN1/FAN2/FAN3	
Pin number	Name of the signal or signification
1	Sensor
2	+12V
3	Control on/off

For the TX5N, if the CPU Fan power has only two threads, connect them to PIN2 and PIN3.

***Adjusting other jumpers:***

Some jumpers are reserved for future functions or are not to be adjusted in normal operation. Adjust them according to the following recommendations.

**CCMOS** ; **G** Put jumper on pin 1 and pin 2.

***BIOS Setup:***

Parameters and CPU settings After you have followed the steps described above and completed the installation, when you power the computer on, you will see the following message displayed:

**PRESS DEL TO ENTER SETUP**

Press immediately Del key to enter BIOS Setup. Select Load Setup Defaults, than enter CPU Soft Menu to set CPU parameters.















**Pentium 200MHz**

	CPU Speed	CPU Spec	Internal Clock	Bus Factor	External Clock	Power		CPU Timing	DP Supp.	Note	
						Vcore	VIO				
P54CS	200 MHz	Q0951	200MHz	3	66MHz	VRE			No	PPGA up	
P54CS		SY045	200MHz	3	66MHz	VRE		Kit	No	PPGA up	
P54CS		Q0951F	200MHz	3	66MHz	VRE		Kit	Yes	PPGA	
P54CS		SY044	200MHz	3	66MHz	VRE			Yes	PPGA	
P55C		Q018	200MHz	3	66MHz	2.8V	3.3V				PPGA

**Pentium 233MHz**

	CPU Speed	CPU Speed	Internal Clock	Bus Factor	External Cclock	Vcore	VIO	CPU Timing	DIP Supp	Note
P55C	200MHz	SY060	200MHz	3	66MHz	2.8V	3.3V			PPGA
P55C	233MHz	SL2BM	233MHz	3	66MHz	2.8V	3.3V			PPGA

☆ **Bus Factor**

<b>Power</b>	<b>STD</b>	3.15V~3.465V (Recommended voltage is 3.38V)
	<b>VR</b>	3.300V~3.465V (Recommended voltage is 3.38V)
	<b>VRE</b>	3.450V~3.6V (Recommended voltage is 3.52V)
<b>Timing</b>	<b>STD</b>	Standard Timing
	<b>MD</b>	Min. Delay (denoting shorter minimum valid delay AC timing for some signal)
	<b>Kit</b>	Supports timing for C55/C88 cache chipsets & design

**P54C**

1. Beginning with the P54C E-Step, standard timings have been replaced by existing Min Delay timing.

**P54CS**

1. P54CS PPGA UP:No DP,No APIC,No FRC
2. Beginning with the P54C E-Step, standard timings have been replaced by existing Min Delay timing.

**P55C**

1. P55C A-Step is NOT production stepping
2. A-1 step: Vcc and timing on initial samples is 2.9V +/- 0.1V
3. A-2 Step and B step: Vcc and timing on production stepping is 2.8V +/- 0.1V

# Appendix C AMD-K5 CPUs

Recognizing AMD CPU speed, voltage and package:

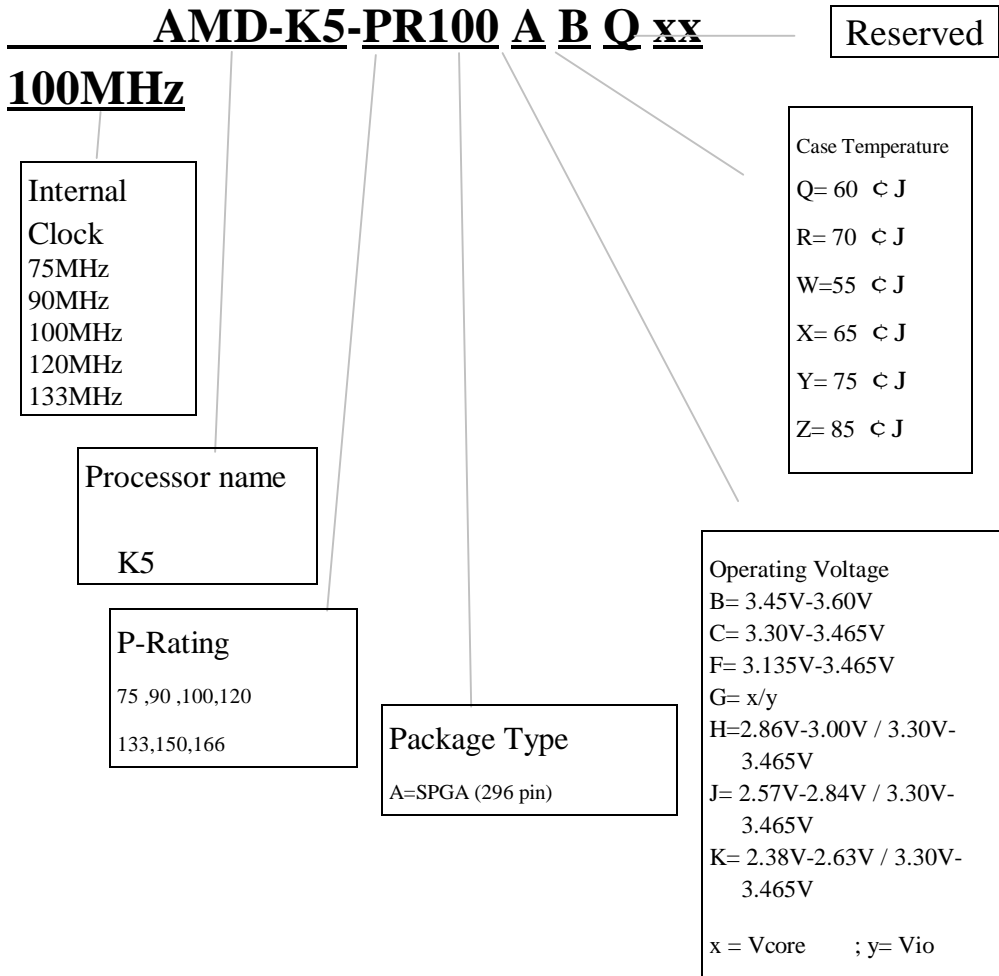





# Appendix D      Cyrix/IBM 6x86 CPUs

---

Recognizing Cyrix CPU speed and voltage:

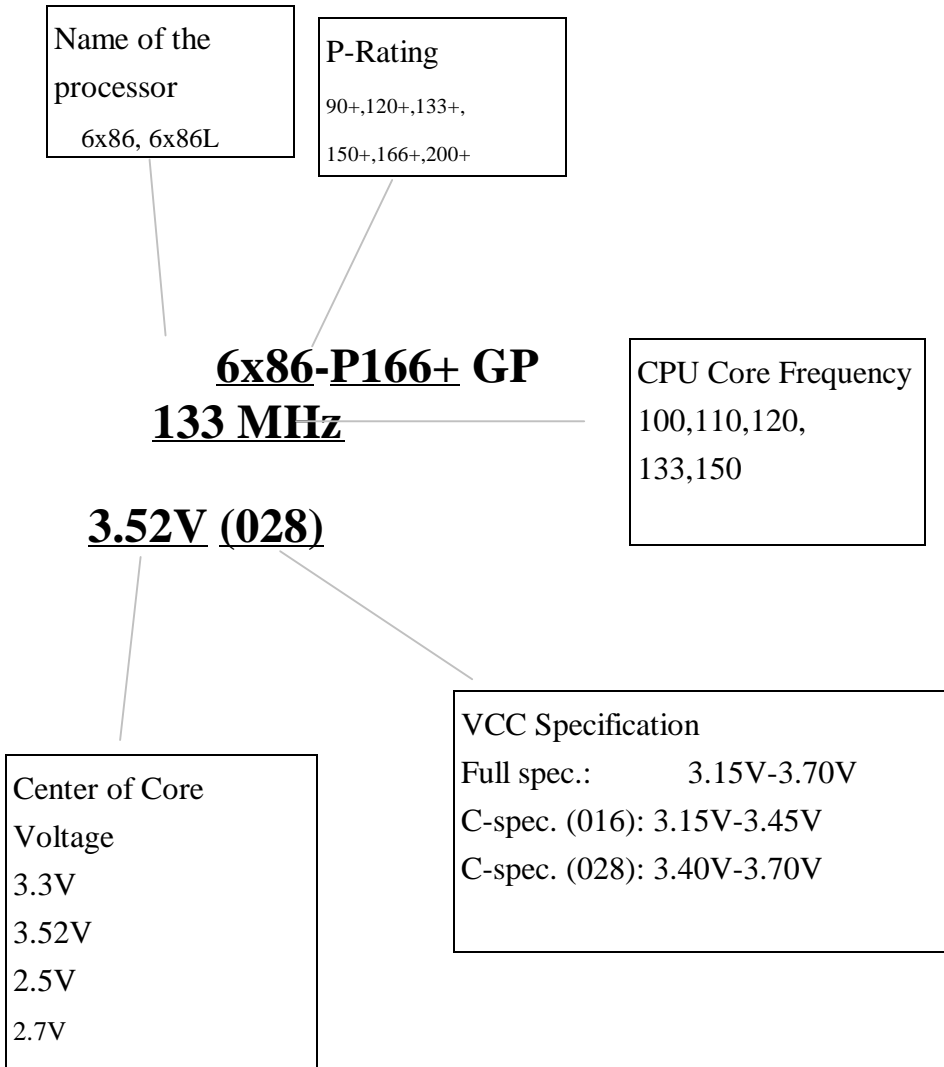



# **Appendix E      General Discussion about HDD Installation**

---

Most recent HDDs use IDE interface. Installing an IDE hard disk does not require great intelligence like installing the driver for a SCSI hard disk, but this means that the user must install the hard disk by themselves and cope with all the problems he may encounter. Here, we will try to help you solve these possible problems.

The data stored on the hard disk is accessed through a chipset located on the mainboard. You probably have heard about the PIO mode, Master mode or DMA mode of HDD. These modes reflect the way data is transferred to and from the IDE drive and the mainboard.

What is the PIO mode? When the system needs to access hard disk data, the CPU delivers input/output (I/O) orders through the chipset on the mainboard to the hard disk drive, and then puts this data into the system memory. This is the PIO mode.

What is the Master mode? When the system needs to access hard disk data, this data is directly accessed from the hard disk by the chipset on the mainboard (using a DMA or a PIO mode), and then the data is put into the memory. In this case, the CPU does not participate in the data transfer.

What is the DMA mode? Usually, DMA mode refers to accessing the hard disk data by the chipset, it does not refer to the data transfer mode.

Here are some examples of data transfer rates for IDE HDD with PIO interface:

- PIO Mode 0 The fastest data transfer rate reaches 3.3Mbyte/sec
- PIO Mode 1 The fastest data transfer rate reaches 5.2Mbyte/sec
- PIO Mode 2 The fastest data transfer rate reaches 8.3Mbyte/sec
- PIO Mode 3 The fastest data transfer rate reaches 11.1Mbyte/sec
- PIO Mode 4 The fastest data transfer rate reaches 16.6Mbyte/sec

The higher the MODE value is, the better the hard disk data transfer rate. But this does not mean that you can select the highest mode value as you like. You must be sure that your hard disk supports that type of fast data transfer, otherwise your hard disk will not be able to operate correctly.

Here are some examples of data transfer rates for IDE HDD with DMA mode:

DMA Mode 0 The fastest data transfer rate reaches 4.16Mbyte/sec

DMA Mode 1 The fastest data transfer rate reaches 13.3Mbyte/sec

DMA Mode 2 The fastest data transfer rate reaches 16.6Mbyte/sec

Usually, PIO mode means the hard disk data is only accessed by the CPU through the chipset and placed into memory, and the chipset is using PIO mode to access hard disk data.

MASTER mode means that hard disk data is accessed by the chipset, and the chipset places the data into memory. The chipset uses DMA or PIO mode to access data stored in the hard disk drive. The Master mode can reduce the CPU load, especially in a Multi-task environment. This can help system performance.

**Installing a hard disk:**

In the **Standard CMOS Setup Menu**,

- ◆ Primary means the first connector on the mainboard, that is, connector IDE1 on our mainboard.
- ◆ Secondary means the second connector on the mainboard, that is, connector IDE2 on our mainboard.
- ◆ Two HDDs can be connected to the each connector:  
The first HDD is referred to as Master,  
The second HDD is referred to as Slave.

*The Master or Slave status of the hard disk drive is set on the hard disk itself. Refer to the hard disk drive manual.*

**Installing one HDD :** The red line on the connection cable must be lined up with pin 1 on the connector.

Be sure that your hard disk drive is set at Master. Actually, most hard disk drives are set at Master as a default, so you don't need to adjust any setting. Just connect one end of the 40 pin cable on the drive connector, and the other end to connector IDE1 on the mainboard.

**Installing one HDD + one CD-ROM drive:** The red line on the connection cable must be lined up with pin 1 on the connector.

Method 1: Set the HDD at Master, and the CD-ROM drive at Slave.  
Connect one connector of the 40-pin cable to the hard disk, another one to the CD-ROM drive, and the other end to connector IDE1 on the mainboard.

Method 2: Set the HDD as Master and connect one end of the 40-pin cable to the HDD, and the other end to connector IDE1 on the mainboard.

You can ignore the setting of the CD-ROM drive, just connect one end of the 40-pin cable to the CD-ROM drive, and the other end to connector IDE2 on the mainboard.

We recommend you use this kind of connection, which has no influence on HDD speed.

**Installing two HDDs:** The red line on the connection cable must be lined up with pin 1 on the connector.

Method 1: Set the hard disk drive used for boot up at Master, and the other drive at Slave. Connect one of the connectors of the 40-pin cable to the first drive, another connector to the second drive, and the other end of the cable to connector IDE1 on the mainboard.

Method 2: Set the hard disk drive used for boot up at Master, connect one end of the 40-pin cable to the drive, and the other end to connector IDE1 on the mainboard.  
Set the other hard disk drive at Master, connect one end of the 40-pin cable to the drive, and the other end to connector IDE2 on the mainboard.

**Installing two HDDs + one CD-ROM drive:** The red line on the connection cable must be lined up with pin 1 on the connector.

Method 1: Set the hard disk drive used for boot up as Master, set the other HDD at Slave, connect one connector of the 40-pin cable to the first drive, another connector to the second drive, and the other end of the cable to connector IDE1 on the mainboard.

You can ignore the setting of the CD-ROM drive. Connect one end of the 40-pin cable to the drive, and the other end to connector IDE2 on the mainboard.

We recommend you use this method, which has no influence on HDD speed.

Method 2: Set the hard disk drive used for boot up at Master, connect one end of the 40-pin cable to the drive, and the other end to connector IDE1 on the mainboard.

Set the other hard disk drive at Master, and be sure that the CD-ROM drive is set at Slave. Most of CD-ROM drives are set at Slave as a default, so you will normally not have to set the CD-ROM drive. After you have verified the settings, connect one connector of the 40-pin cable to the HDD, another connector to the CD-ROM drive, and the other end of the cable to connector IDE2 on the mainboard.

**Installing three HDDs:** The red line on the connection cable must be lined up with pin 1 on the connector.

Method 1: Set the hard disk drive used for boot up at Master, set the second drive at Slave. Connect one connector of the 40-pin cable to the first drive, another connector to the second drive, and the other end of the cable to connector IDE1 on the mainboard.

Set the other (the third) drive at Master, and connect one end of the 40-pin cable to the drive, and the other end to connector IDE2 on the mainboard.

Method 2: Set the hard disk drive used for boot up at Master, and connect one end of the 40-pin cable to the drive and the other end to connector IDE1 on the mainboard. Set another drive (the second drive) at Master and the third drive at Slave, connect one connector of the 40-pin cable to the second drive, another connector to the third drive, and the other end of the cable to connector IDE2 on the mainboard.

**Installing three HDDs + one CD-ROM drive:** The red line on the connection cable must be lined up with pin 1 on the connector.

Set the hard disk drive used for boot up at Master, set another HDD (the second) at Slave, connect one connector of the 40-pin cable to the first drive, another connector to the second drive, and the other end of the cable to connector IDE1 on the mainboard.

Set the third hard disk drive at Master, set the CD-ROM drive at Slave, connect one connector of the 40-pin cable to the third HDD, another connector to the CD-ROM drive, and the other end of the cable to connector IDE2 on the mainboard.

**BIOS Setup:**

- ◆ If all your HDDs are new, you can use the **IDE HDD Auto Detection** option in the CMOS to autodetect the parameters of all your drives. You don't need to set any hard disk parameter.
- ◆ If one or several of your HDDs are old, and if you don't know their parameters, and you want to reconfigure your drives, you can also use the **IDE HDD Auto Detection** option in the CMOS to autodetect the drives parameters.
- ◆ If one or several of your HDD are old, and if you don't want to erase the data stored in your drives, you will have to remember the parameters (Type, Cylinders, Heads, Sectors, and) of the drive(s) you don't want to erase. If you have set the **IDE HDD Auto Detection** option in the CMOS, enter the **Standard CMOS Setup Menu** to change the setting for the hard disk drive.

**Software :**

The easiest way to install a hard disk is to use a **DD Low Level Format**, hard disk, and an **FDISK** utility. Most of the hard disks have already been formatted by the manufacturer, so you probably don't need to format them.

With a bootable floppy disk, then enter **FDISK**.

Using **FDISK**: (DOS command)

This command is found in the DOS disks.

**FDISK** is a tool used to organize and to partition the hard disk. The hard disk must have been partitioned before use. You can create one unique partition on the hard disk, or create several partitions and use a different Operating System on each partition. Just don't forget that you have to specify an Active partition, otherwise your hard disk will not be bootable. For further information on **FDISK**, refer to the **FDISK** section in the DOS Setup manual.

After you have partitioned the hard disk with **FDISK**, the system will reboot automatically. Boot from the system floppy disk, and type **OR AT C: S**



Using FORMAT: (DOS command)

This command is found in the DOS disks.

FORMAT is used to format the hard disk. The HDDs have to be formatted before use. Don't forget to add /S after C:, otherwise the hard disk will not be bootable after formatting.



## **Appendix F      Technical Support**

---

### ☹ When you have a problem during operation...

In order to help our technical support personnel to quickly find out what is the problem of your mainboard and to give you the answers you need, before filling in the technical support form, eliminate any peripheral that is not related to the problem, and indicate on the form the key peripherals. Fax this form to your dealer or to the company where you bought the hardware in order to benefit from our technical support. (You can refer to the examples given below.)



Example 1: With a system including: mainboard (with CPU, DRAM, COAST...) HDD, CD-ROM, FDD, VGA CARD, MPEG CARD, SCSI CARD, SOUND CARD..., after the system is assembled, if you cannot boot up, check the key components of the system using the procedure described below.

First remove all interface cards except the VGA card and try to reboot.

☞ If you still cannot boot up:

Try installing another brand/model VGA card and see if the system will start. If it still does not start, note the VGA card model, mainboard model, Bios identification number, CPU on the technical support form (refer to main instructions), and describe the problem in the problem description space provided.

☞ If you can boot up:

Insert back the interface cards you have removed one by one and try to start the system each time you insert a card, until the system doesn't start anymore. Keep the VGA card and the interface card that causes the problem inserted on the mainboard, remove any other card or peripheral, and start again. If you still cannot start, note down the information related to both cards in the Add-On Card space provided, and don't forget to indicate the mainboard model, version, BIOS identification number, CPU (refer to main instructions), and give a description of the problem.



Example 2: With a system including the mainboard (with CPU, DRAM, COAST...) HDD, CD-ROM, FDD, VGA CARD, LAN CARD, MPEG CARD, SCSI CARD, SOUND CARD, after assembly and after having installed the Sound Card Driver, when you restart the system, when it runs the Sound Card Driver, it resets automatically. This problem may be due to the Sound Card Driver. During the Starting DOS... procedure, press SHIFT (BY-PASS) key, to skip CONFIG.SYS and AUTOEXEC.BAT; edit CONFIG.SYS with a text editor, and in front on the line that loads the Sound Card Driver, add a remark REM, in order to disable the Sound Card Driver. See the example below.

```
CONFIG.SYS:  
DEVICE=C:\DOS\HIMEM.SYS  
DEVICE=C:\DOS\EMM386.EXE HIGHSCAN  
DOS=HIGH,UMB  
FILES=40  
BUFFERS=36  
REM DEVICEHIGH=C:\PLUGPLAY\DWCFGMG.SYS  
LASTDRIVE=Z
```

Restart the system. If the system starts and does not reset, you can be sure that the problem is due to the Sound Card Driver. Note down the Sound Card model, mainboard model, BIOS identification number on the technical support file (refer to main instructions), and describe the problem in the space provided.



Main instructions...

To fill in this “Technical Support Form”, refer to the step-by-step instructions given below:

**\*1. MODEL:** Note the model number given in your user’s manual.

Example: PT5R2, PR5R2...

**\*2. Mainboard model number (REV):** Note the mainboard model number labeled on the mainboard as “REV: .\* ”.

Example: EV 2. 1

**\* BIOS ID :** See below :

Example

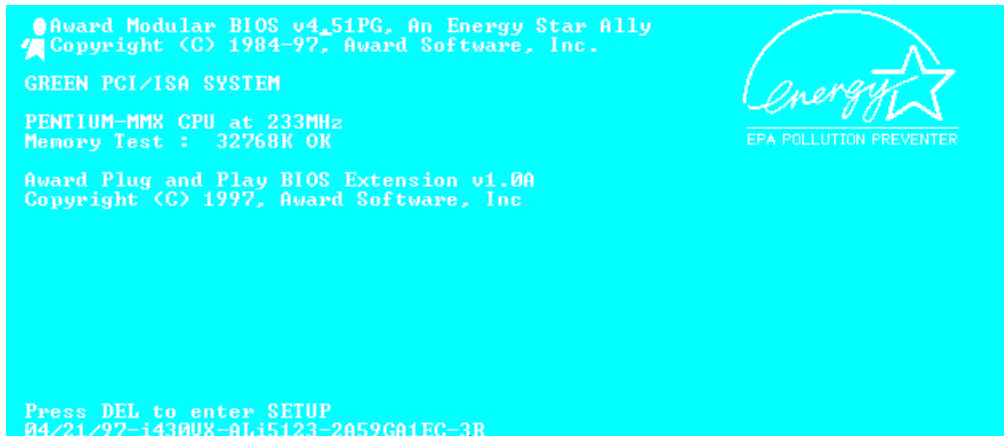

“3R” is the “BIOS” ID number

“2A59GA1EC” is the “BIOS” part number

- 4. DRIVER REV:** Note the driver version number indicated on the DEVICE DRIVER disk as “Release \*.\*”.

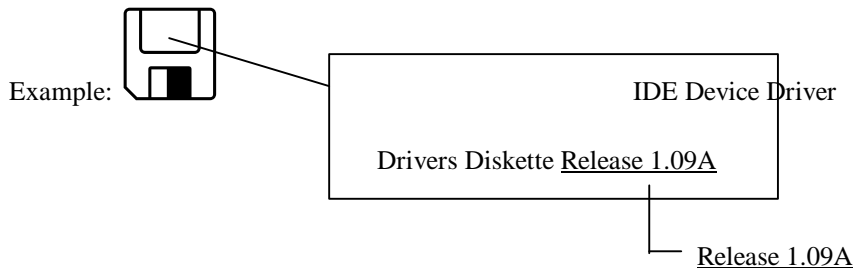

- \*5. OS/APPLICATION:** Indicate what are the operating system and the applications your are running on the system.

Example: MS-DOS 6.22, Windows 3.1....

- \*6. CPU:** Indicate the brand and the speed (MHz) of your CPU.

Example: (A) In the “Brand” space, write “Intel”, in the “Specifications” space, write “150MHz” ; C

(B) In the “Brand” space, write “Cyrix”, in the “Specifications” space, write “P166+” ; C

(C) In the “Brand” space, write “AMD”, in the “Specifications” space, write “P75”.

- 7. HDD:** Indicate the brand and specifications of your HDD(s), specify if the HDD is using  IDE1 or  IDE2. If you know the disk capacity, indicate it and check (“✓”) ; in case you give no indication, we will consider that your HDD is  IDE1” Master.

Example: In the “HDD” space, check the box, in the Brand space, write “Seagate”, in the Specifications space, write “ST31621A (1.6GB)”.

- 8. CD-ROM Drive:** Indicate the brand and specifications of your CD-ROM drive, specify if it uses  IDE1 or  IDE2 ; A and check (“✓”) ; in case you give no indication, we will consider that your CD-ROM is  IDE2” Master.

Example: In the “CD-ROM drive” space, check the box, in the Brand space, write “Mitsumi”, in the Specifications space, write “FX-400D”.

- 9. System Memory (DRAM):** Indicate the brand and specifications (SIMM/DIMM) of your system memory.

Examples:

In the Brand space, write “Panasonic”, in the Specifications space, write “SIMM-FP DRAM 4MB-06”.

Or, in the Brand, write “NPNX”, in the Specifications space, write “SIMM-EDO DRAM 8MB-06”.

Or, in the Brand space, write “SEC”, in the Specifications space, write “DIMM-S DRAM 8MB-G12”.

- 10. COAST:** Indicate the brand and specifications of your COAST.

Example: In the Brand space, write “Winbond”, in the Specifications space, write “256KB” or “W25P010AF-8”<sub>i</sub> C

- 11. ADD-ON CARD:** Indicate which add-on cards you are “absolutely sure” are related to the problem.

If you cannot identify the problem origin, indicate all the add-on cards inserted into your system.

**Note:** *Items between the “\*” are absolutely necessary.*



## Technical Support Form

Company name:

☎ Phone #:

☺ Contact:

☎ Fax #:

Model	*	BIOS ID #	*
Mainboard model no.		DRIVER REV	
OS/Application	*		
Hardware name	Brand	Specifications	
C.P.U	*		
HDD <input type="checkbox"/> IDE1 <input type="checkbox"/> IDE2			
CD-ROM Drive <input type="checkbox"/> IDE1 <input type="checkbox"/> IDE2			
System Memory (DRAM)			
COAST			
ADD-ON CARD			

✍ Problem Description: \_\_\_\_\_

\_\_\_\_\_

\_\_\_\_\_



# Appendix G Flash BIOS User Instructions

---

```
FLASH MEMORY WRITER v5.34
Copyright (C) 1996, Award Software, Inc..

AWDFLASH [ <FLASH>[PATH][FILENAME]] [ /Py, Pn ]
          [ <SAVE>[PATH][FILENAME]] [ /Sy, Sn ]
          [ <CLEAR CMOS>[ /CC ] ] [ <CLEAR PnP>[ /CP ] ]
          [ /? ]

[Py/Pn] PROGRAM BIOS ANSWER Y or N.
[Sy/Sn] SAVE OLDBIOS ANSWER Y or N.
[/?] FOR HELP ?

EXAMPLE 1 : AWDFLASH NEWBIOS /Py SAVEBIOS /Sy
EXAMPLE 2 : AWDFLASH NEWBIOS SAVEBIOS /CC
EXAMPLE 3 : AWDFLASH NEWBIOS /Sn /CP
EXAMPLE 4 : AWDFLASH /Pn SAVEBIOS

Error Message:
```

Example 1 To update BIOS and create a backup of the current system BIOS execute this command:

**AWDFLASH NEWBIOS /Py SAVEBIOS**

**/Sy**

Example 2 To update BIOS, create a backup of current system BIOS, and clear the CMOS, execute this command:

**AWDFLASH NEWBIOS SAVEBIOS /CC**

Example 3 To update BIOS and clear PnP settings execute this command:

**AWDFLASH NEWBIOS /Sn /CP**

Example 4 To make a backup of the current system BIOS execute the following command:

**AWDFLASH NEWBIOS /Pn SAVEBIOS**

Notes: "NEWBIOS" indicates file name for the new BIOS which can be downloaded from our website at <http://www.abit.com.tw> (user can choose a different file name in place of NEWBIOS).

"SAVEBIOS" indicates the filename of the old system BIOS (user can choose a different file name in place of SAVEBIOS).

## G-2

### Appendix G

Explanation of parameter names:

/CC: Clears CMOS data

/CP: Clears PnP data

Remarks:

- ① When executing AWDFLASH.EXE, do not run HIMEM.SYS and EMM386.EXE in the CONFIG.SYS.
- ② Please take the following actions to solve problems caused by power shortage or other other unpreventable malfunctions during BIOS update that lead to update failure. First, it is strongly suggested that you format a disk that can boot your computer before you update your BIOS. If the above mentioned problem occurs during BIOS update you will be able to use this disk to automatically execute a BIOS update. The content of the disk should be the following:
  - a. Startup system files (COMMAND.COM, MSDOS.SYS, IO.SYS...)
  - b. AWDFLASH.EXE
  - c. The NEWBIOS file which can be downloaded from ABIT's website.
  - d. AUTOEXEC.BAT, which has the following content:  
**A:\AWDFLASH NEWBIOS /Py /Sn /CC .**
- ③ When a version of BIOS that is for the incorrect mainboard model the following message will appear:  
**“The program file's part number does not match with your system!”**

