

FCC Information and Copyright

This equipment has been tested and found to comply with the limits of a Class B digital device, pursuant to Part 15 of the FCC Rules. These limits are designed to provide reasonable protection against harmful interference in a residential installation. This equipment generates, uses and can radiate radio frequency energy and, if not installed and used in accordance with the instructions, may cause harmful interference to radio communications. There is no guarantee that interference will not occur in a particular installation.

The vendor makes no representations or warranties with respect to the contents here and specially disclaims any implied warranties of merchantability or fitness for any purpose. Further the vendor reserves the right to revise this publication and to make changes to the contents here without obligation to notify any party beforehand.

Duplication of this publication, in part or in whole, is not allowed without first obtaining the vendor's approval in writing.

The content of this user's manual is subject to be changed without notice and we will not be responsible for any mistakes found in this user's manual. All the brand and product names are trademarks of their respective companies.

Table of Contents

Chapter 1: Introduction	1
1.1 Motherboard Features	1
1.2 Package List	4
1.3 Layout and Components	5
Chapter 2: Hardware Installation	6
2.1 Installing Central Processing Unit (CPU)	6
2.2 FAN Headers	8
2.3 Installing System Memory	9
2.4 Connectors and Slots	10
Chapter 3: Headers & Jumpers Setup	13
3.1 How to Setup Jumpers	13
3.2 Detail Settings	13
Chapter 4: Useful Help	20
4.1 Award BIOS Beep Code	20
4.2 Extra Information	20
4.3 Troubleshooting	22
Chapter 5: WarpSpeeder™	23
5.1 Introduction	23
5.2 System Requirement	23
5.3 Installation	24
5.4 [WarpSpeeder™] includes 1 tray icon and 5 panels	25
Appendix:	32
Certified PCI-Express VGA Card List	32

PT880 Pro-A7 DDR2

CHAPTER 1: INTRODUCTION

1.1 MOTHERBOARD FEATURES

CPU

- Supports LGA775.
- Supports Intel Pentium 4 processor up to 3.8GHz.
- Supports Intel Pentium D processor.
- Supports Intel Celeron D processor.
- Front side bus at the following frequency ranges:
 - 533MHz (133MHz Core Clock)
 - 800MHz (200MHz Core Clock)
- Supports Hyper-Threading Technology.

WARNING!

Warranty will be void if the pin protection cap is not in place to protect the socket pin when sending this motherboard for service.

Chipset

- North Bridge: VIA PT880 Pro.
- South Bridge: VIA VT8237R PLUS.

Dimension

- ATX Form Factor: 29.3cm (L) x 21.0cm (W)

Operating System Supporting

- Supports Windows 98 / Me / 2000 / XP.

System Memory

- Supports Dual Channel DDR2.
- Supports DDR2 400/533
- Maximum memory capacity is 2GB, supporting 2 DIMM sockets. (Following table is only for reference.)

DIMM Socket Location	DDR Module	Total Memory Size
DIMMA1	256MB/512MB/1GB*1	Max is 2 GB.
DIMMA2	256MB/512MB/1GB*1	

PT880 Pro-A7 DDR2

Slot

- Four 32-bit PCI bus master slots.
- One AGP 3.0 (8X) compatible slot.
- One PCI-Extreme (PE1) slot. (See p.11 for detail information)

10/100 LAN PHY

- PHY: RTL8201BL.
- Supports 10 Mb/s and 100 Mb/s auto-negotiation.
- Half/Full duplex capability.
- Supports ACPI, PCI power management.

Onboard Serial ATA

- Integrated in VT8237R PLUS.
- Supports RAID 0 and RAID 1 functions.
- Supports 2 serial ATA (SATA) ports.
 - Data transfer rates up to 150 MB/s.
 - Compliant with SATA Version 1.0 specification.

Super I/O

- Chip: ITE 8705AF.
- Provides the most commonly used legacy super I/O functionality.
- Environment Control initiatives:
 - H/W Monitor.
 - Fan Speed Controller.
 - ITE "Smart Guardian" function.

Onboard IDE

- Two IDE connectors support 4 hard disk drives.
- Supports PIO mode 0~4.
- Supports Ultra DMA 33/66/100/133 Bus Master Mode.

Onboard AC'97 Sound CODEC

- Chip: REALTEK ALC655.
- Support 6 channels.
- Supports SPDIF-out functions.
- Compliant with AC'97 Version 2.3 specification.

PT880 Pro-A7 DDR2

Internal On-board I/O Connectors and Headers

- 1 front panel header supports front panel facilities.
- 1 CD-in connector supports 1 CD-ROM audio-in device.
- 1 S/PDIF-Out connector supports digital audio-out function.
- 1 front audio header supports front panel audio-out function.
- 1 chassis open header supports PC case-opened warning function.
- 1 FDD connector supports 2 Floppy drives with 360K, 720K, 1.2M, 1.44M and 2.88Mbytes.
- 2 IDE connectors support 4 hard disk devices.
- 2 Serial ATA connectors support 2 SATA devices.
- 2 USB headers support 4 USB 2.0 ports at front panel.

Back Panel I/O Connectors

- 4 USB 2.0 ports.
- 1 COM port. (COM2 is optional)
- 1 Printer port.
- 1 RJ-45 LAN jack
- 1 PS/2 Mouse port.
- 1 PS/2 Keyboard port.
- 1 Vertical audio port including 1 line-in connector, 1 line out connector, and 1 MIC in connector.

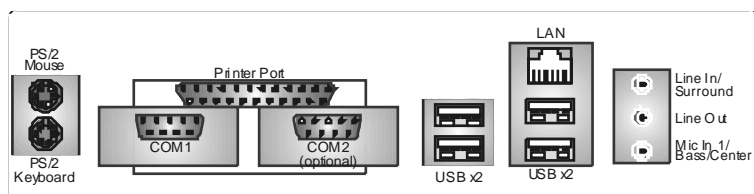

PT880 Pro-A7 DDR2

1.2 PACKAGE LIST

- ✦ FDD cable x 1
- ✦ HDD cable x 1
- ✦ User's Manual x 1
- ✦ Fully Setup Driver CD x 1
- ✦ Rear I/O panel for ATX case x 1
- ✦ USB 2.0 cable x 1 (optional)
- ✦ Serial ATA cable x 1 (optional)
- ✦ S/PDIF out cable x 1 (optional)

PT880 Pro-A7 DDR2

1.3 LAYOUT AND COMPONENTS

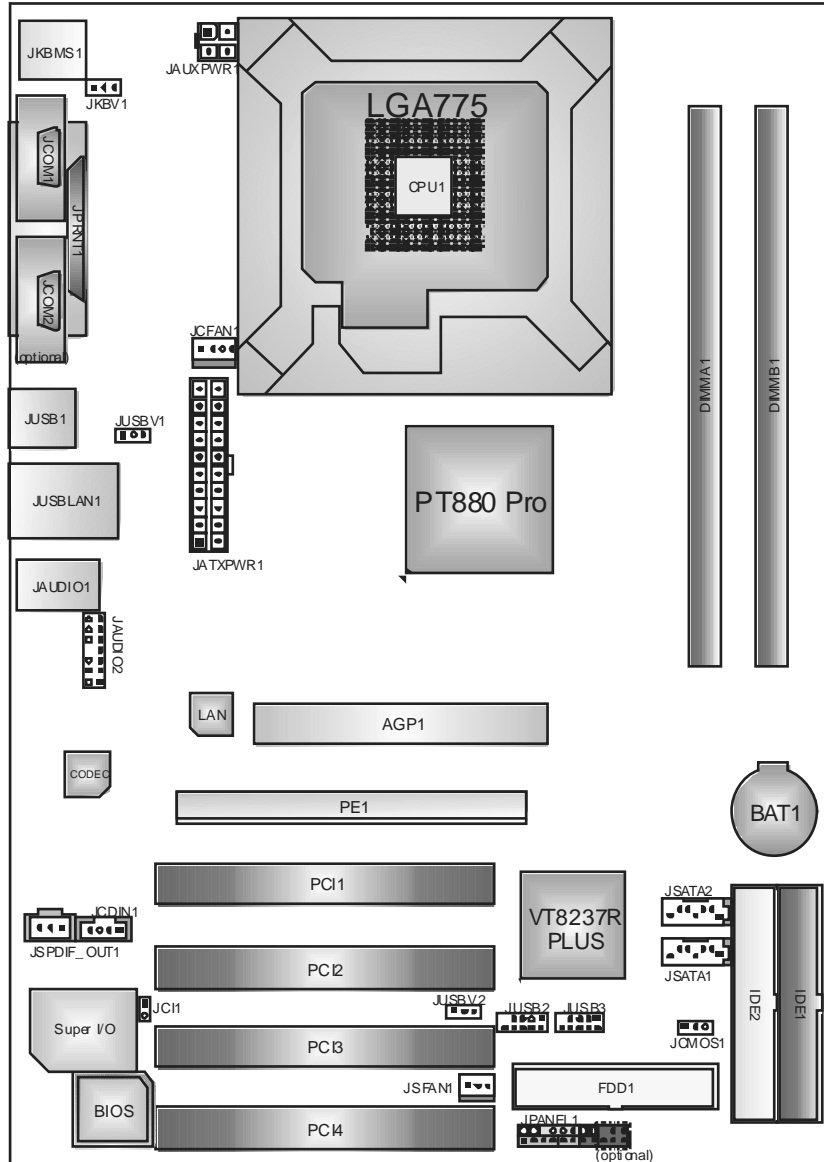

Note: ■ represents the 1st pin.

CHAPTER 2: HARDWARE INSTALLATION

2.1 INSTALLING CENTRAL PROCESSING UNIT (CPU)

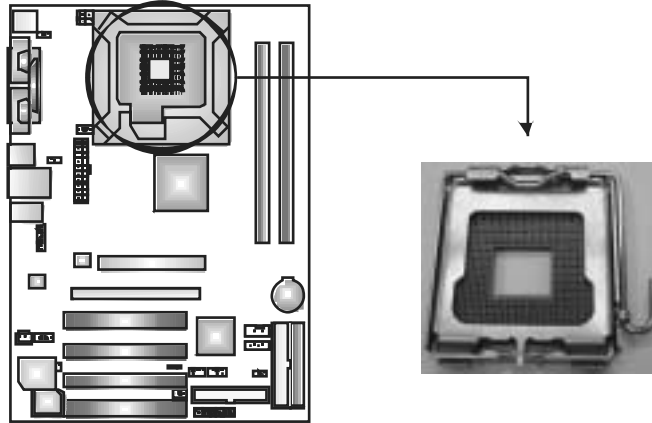

Special Notice

Remove Pin Cap before installation, and make good preservation for future use. When the CPU is removed, cover the Pin Cap on the empty socket to ensure pin legs won't be damaged.



Step 1: Pull the lever sideways away from the socket and then raise the lever up to a 90-degree angle.

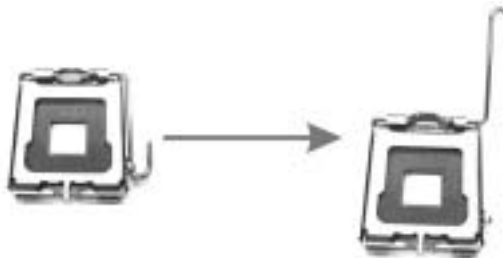

PT880 Pro-A7 DDR2

Step 2: Look for the black cut edge on socket, and the white dot on CPU should point wards this black cut edge. The CPU will fit only in the correct orientation.

Step 2-1:



Step 2-2:



Step 3: Hold the CPU down firmly, and then close the lever to complete the installation.



Step 4: Put the CPU Fan on the CPU and buckle it. Connect the CPU FAN power cable to the JCFAN1. This completes the installation.

PT880 Pro-A7 DDR2

2.2 FAN HEADERS

These fan headers support cooling-fans built in the computer. The fan cable and connector may be different according to the fan manufacturer. Connect the fan cable to the connector while matching the black wire to pin#1.

JCFAN1: Power Source Header for CPU Fan

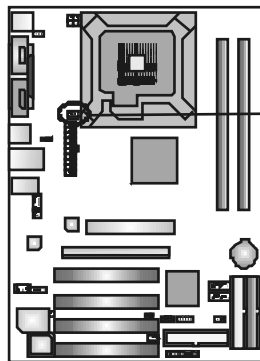

Pin	Assignment
1	Ground
2	Power
3	FAN RPM rate sense
4	Smart Fan Control

JSFAN1: Power Source Header for System Fan

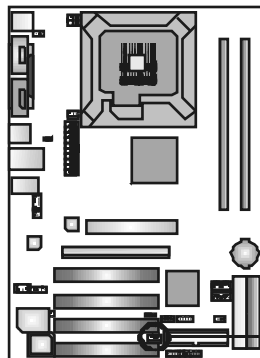

Pin	Assignment
1	Ground
2	+12V
3	FAN RPM rate sense

Note:

The JCFAN1 reserves cooling fan with Smart Fan Control utility. It supports 4-pin head connector. When connecting with wires onto connectors, please note that the red wire is the positive and should be connected to pin#2, and the black wire is Ground and should be connected to GND.

PT880 Pro-A7 DDR2

2.3 INSTALLING SYSTEM MEMORY

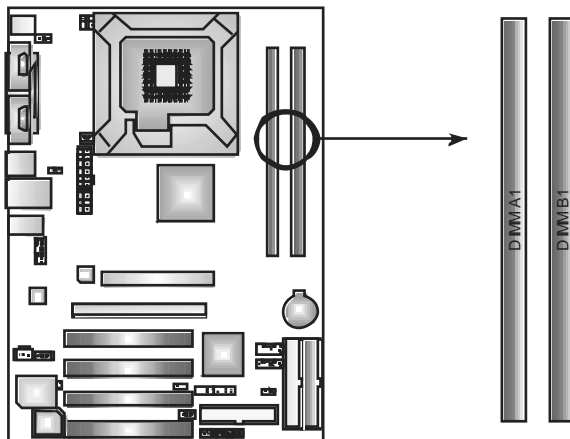

1. Unlock a DIMM slot by pressing the retaining clips outward. Align a DIMM on the slot such that the notch on the DIMM matches the break on the Slot.

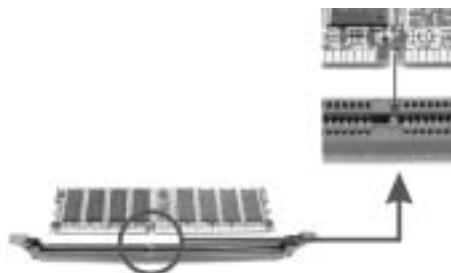

2. Insert the DIMM vertically and firmly into the slot until the retaining chip snap back in place and the DIMM is properly seated.



PT880 Pro-A7 DDR2

2.4 CONNECTORS AND SLOTS

FDD1: Floppy Disk Connector

The motherboard provides a standard floppy disk connector that supports 360K, 720K, 1.2M, 1.44M and 2.88M floppy disk types. This connector supports the provided floppy drive ribbon cables.

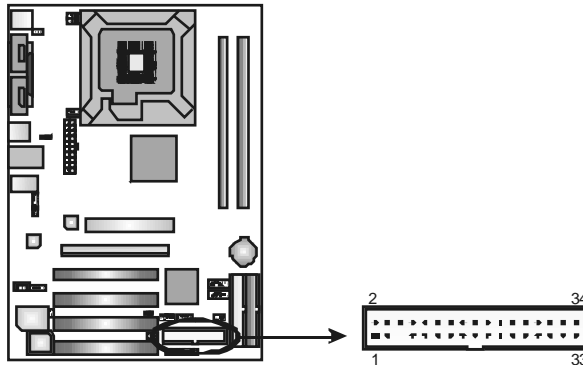

IDE1/IDE2: Hard Disk Connectors

The motherboard has a 32-bit Enhanced PCI IDE Controller that provides PIO Mode 0~4, Bus Master, and Ultra DMA 33/66/100/133 functionality. It has two HDD connectors IDE1 (primary) and IDE2 (secondary). The IDE connectors can connect a master and a slave drive, so you can connect up to four hard disk drives. The first hard drive should always be connected to IDE1.

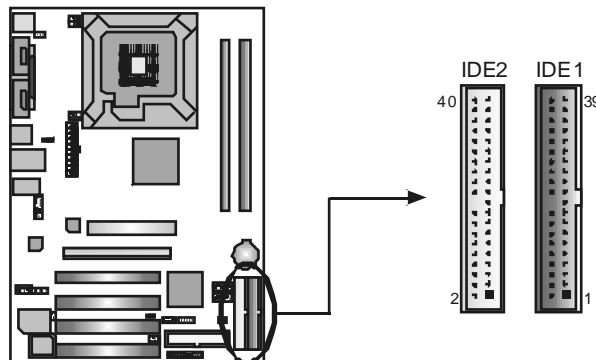

PT880 Pro-A7 DDR2

PCI1~PCI4: Peripheral Component Interconnect Slots

This motherboard is equipped with 4 standard PCI slots. PCI stands for Peripheral Component Interconnect, and it is a bus standard for expansion cards. This PCI slot is designated as 32 bits.

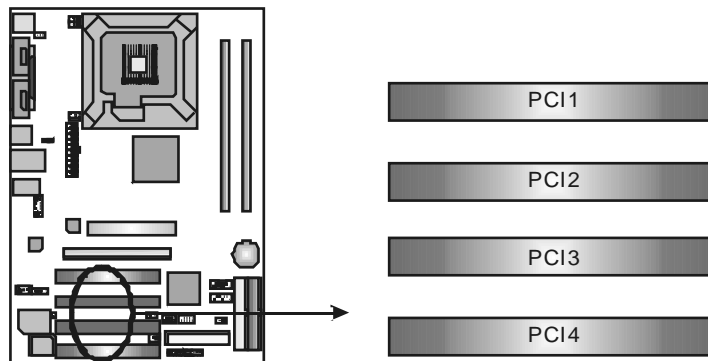

PE1: PCI-Extreme Slot

- PCI-Extreme slot is a special design for PCI-Express interface graphic cards.
- PCI-Extreme slot is compliant with PCI-Express 1.0a specification.
- PCI-Extreme slot is compatible with PCI-E x4 and PCI-E x1 expansion card.
- The bandwidth of data transfer is up to 1GB/s per direction, and for an aggregate of 2GB/s in total.

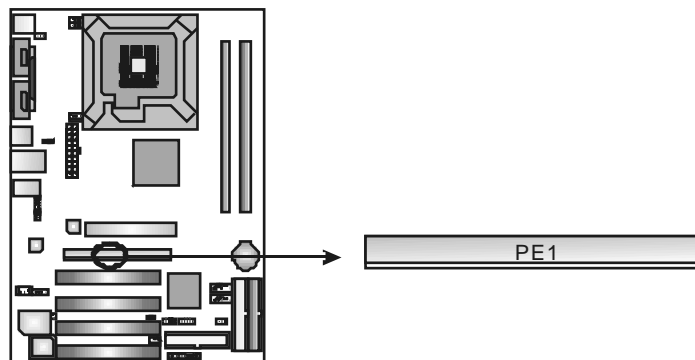

PT880 Pro-A7 DDR2

AGP1: Accelerated Graphics Port Slot

Your monitor will attach directly to that video card. This motherboard supports video cards for PCI slots, but it is also equipped with an Accelerated Graphics Port (AGP). An AGP card will take advantage of AGP technology for improved video efficiency and performance, especially with 3D graphics.

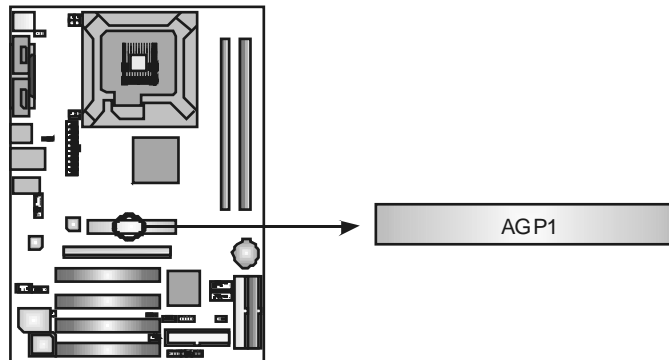

CHAPTER 3: HEADERS & JUMPERS SETUP

3.1 HOW TO SETUP JUMPERS

The illustration shows how to set up jumpers. When the jumper cap is placed on pins, the jumper is “close”, if not, that means the jumper is “open”.



Pin opened



Pin closed



Pin1-2 closed

3.2 DETAIL SETTINGS

JUSBV1/JUSBV2: Power Source Headers for USB Ports

Pin 1-2 Close:

JUSBV1: +5V for USB ports at back panel (JUSB1/JUSBLAN1).

JUSBV2: +5V for USB ports at front panel (JUSB2/JUSB3).

Pin 2-3 Close:

JUSBV1: USB ports at back panel (JUSB1/JUSBLAN1) are powered by +5V standby voltage.

JUSBV2: USB ports at front panel (JUSB2/JUSB3) are powered by +5V standby voltage.

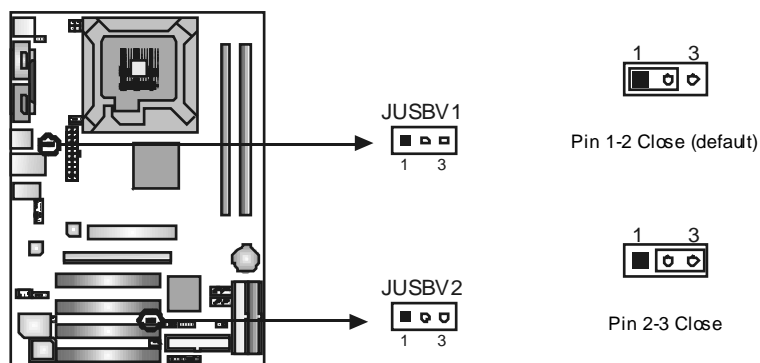

Note:

In order to support this function “Power-On system via a USB device,” “JUSBV1/ JUSBV2” jumper cap should be placed on Pin 2-3 individually

PT880 Pro-A7 DDR2

JKBV1: Power Source Header for PS/2 Keyboard and Mouse

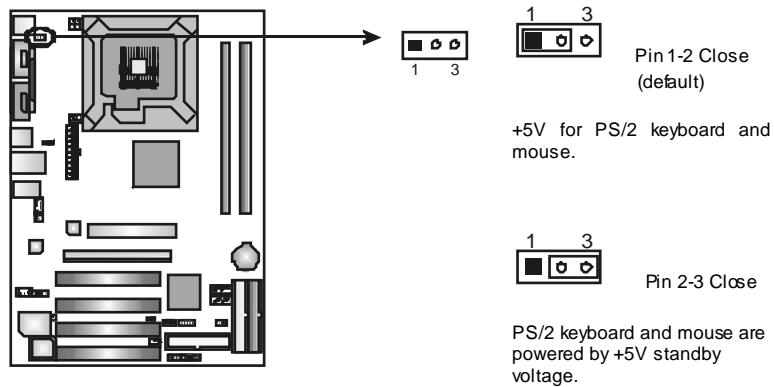

Note:

In order to support this function “Power-on system via keyboard and mouse”, “JKBV1” jumper cap should be placed on Pin 2-3.

JATXPWR1: ATX Power Source Connector

This connector allows user to connect 20-pin power connector on the ATX power supply.

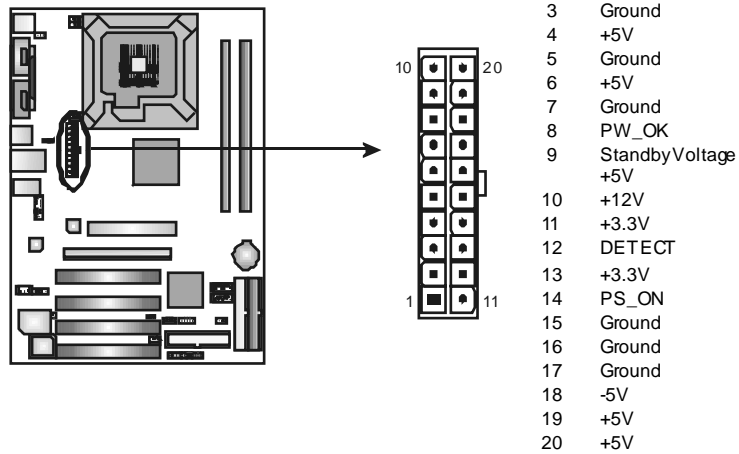

PT880 Pro-A7 DDR2

JAUXPWR1: Power Source Connector for CPU Power Circuit

By connecting this connector, it will provide +12V to CPU power circuit.

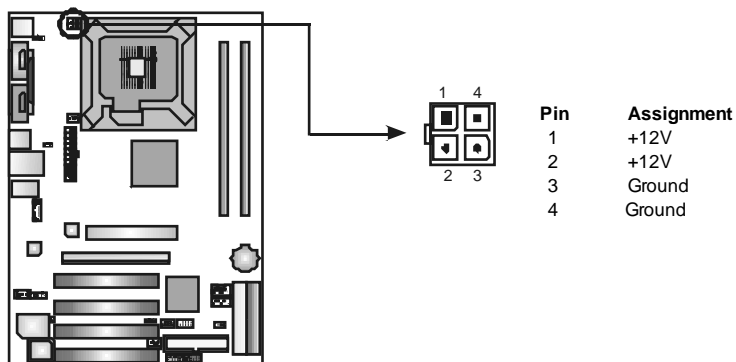

JANEL1: Header for Front Panel Facilities

This 22-pin connector includes Power-on, Reset, HDD LED, Power LED, Sleep button, speaker and IrDA Connection. It allows user to connect the PC case's front panel switch functions.

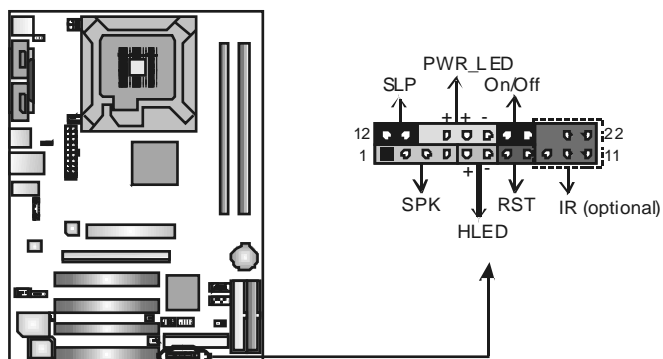

Pin	Assignment	Function	Pin	Assignment	Function
1	+5V	Speaker Connector	12	Sleep control	Sleep button
2	N/A		13	Ground	
3	N/A		14	N/A	N/A
4	Speaker	Hard drive LED	15	Power LED (+)	Power LED
5	HDD LED (+)		16	Power LED (+)	
6	HDD LED (-)	Reset button	17	Power LED (-)	Power-on button
7	Ground		18	Power button	
8	Reset control	IrDA Connector (optional)	19	Ground	IrDA Connector (optional)
9	N/A		20	Key	
10	+5V		21	Ground	
11	IRTX		22	IRRX	

PT880 Pro-A7 DDR2

JUSB2/JUSB3: Headers for USB 2.0 Ports at Front Panel

This header allows user to connect additional USB cable on the PC front panel, and also can be connected with internal USB devices, like USB card reader.

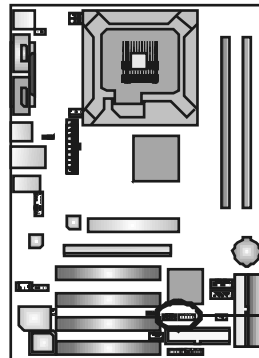

Pin	Assignment
1	+5V (fused)
2	+5V (fused)
3	USB-
4	USB-
5	USB+
6	USB+
7	Ground
8	Ground
9	Key
10	NC

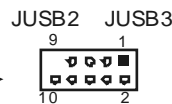

JCMOS1: Clear CMOS Header

By placing the jumper on pin2-3, it allows user to restore the BIOS safe setting and the CMOS data, please carefully follow the procedures to avoid damaging the motherboard.

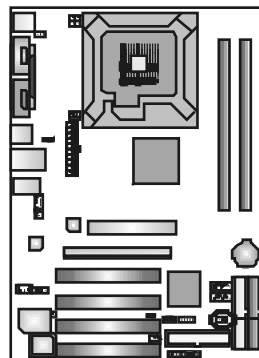

Pin 1-2 Close:
Normal Operation (default).



Pin 2-3 Close:
Clear CMOS data.

※ Clear CMOS Procedures:

1. Remove AC power line.
2. Set the jumper to "Pin 2-3 Close".
3. Wait for five seconds.
4. Set the jumper to "Pin 1-2 Close".
5. Power on the AC.
6. Reset your desired password or clear the CMOS data.

PT880 Pro-A7 DDR2

JCI1: Chassis Open Header

This connector allows system to monitor PC case open status. If the signal has been triggered, it will record to the CMOS and show the message on next boot-up.

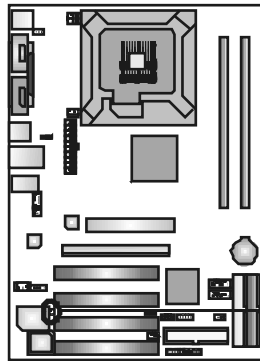

Pin	Assignment
1	Case open signal
2	Ground

JCDIN1: CD-ROM Audio-in Connector

This connector allows user to connect the audio source from the variety devices, like CD-ROM, DVD-ROM, PCI sound card, PCI TV tuner card etc..

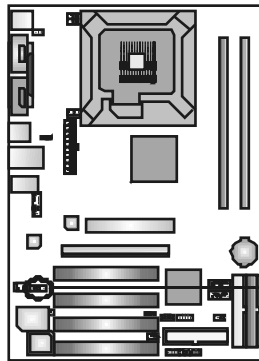

Pin	Assignment
1	Left Channel Input
2	Ground
3	Ground
4	Right Channel Input

PT880 Pro-A7 DDR2

JSATA1/JSATA2: Serial ATA Connectors

The motherboard has a PCI to SATA Controller with 2 channels SATA interface, it satisfies the SATA 1.0 spec and with transfer rate of 1.5Gb/s.

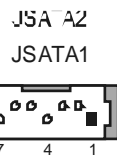
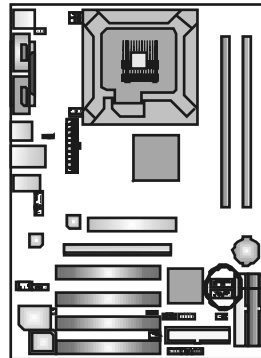

Pin	Assignment
1	Ground
2	TX+
3	TX-
4	Ground
5	RX-
6	RX+
7	Ground

JAUDIO2: Front Panel Audio Header

This header allows user to connect the front audio output cable with the PC front panel. It will disable the output on back panel audio connectors.

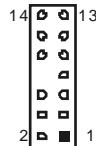
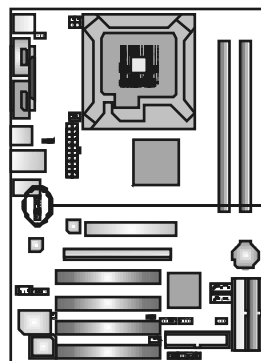

Pin	Assignment
1	Mc-in/Stereo MIC-in R
2	Ground
3	Stereo MIC-in L
4	Audio power
5	Right line-out/ Speaker-out Right
6	Right line-out/ Speaker-out Right
7	Reserved
8	Key
9	Left line-out/ Speaker-out Left
10	Left line-out/ Speaker-out Left
11	Right line-in (optional)
12	Right line-in (optional)
13	Left line-in (optional)
14	Left line-in (optional)

PT880 Pro-A7 DDR2

JSPDIF_OUT1: Digital Audio-out Connectors

These connectors allow user to connect the PCI bracket SPDIF output or input header.

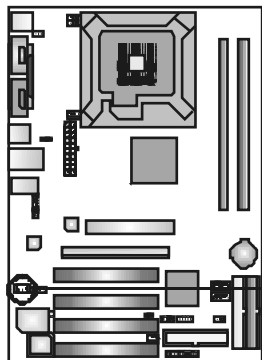

Pin	Assignment
1	+5V
2	SPDIF OUT
3	Ground

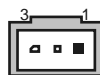

CHAPTER 4: USEFUL HELP

4.1 AWARD BIOS BEEP CODE

Beep Sound	Meaning
One long beep followed by two short beeps	Video card not found or video card memory bad
High-low siren sound	CPU overheated System will shut down automatically
One Short beep when system boot-up	No error found during POST
Long beeps every other second	No DRAM detected or install

4.2 EXTRA INFORMATION

A. BIOS Update

After you fail to update BIOS or BIOS is invaded by virus, the Boot-Block function will help to restore BIOS. If the following message is shown after boot-up the system, it means the BIOS contents are corrupted.

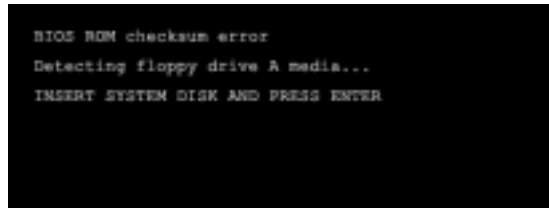

In this Case, please follow the procedure below to restore the BIOS:

1. Make a bootable floppy disk
2. Download the Flash Utility "AWDFLASH.exe" from the Biostar website: www.biostar.com.tw
3. Confirm motherboard model and download the respectively BIOS from Biostar website.
4. Copy "AWDFLASH.exe" and respectively BIOS into floppy disk.
5. Insert the bootable disk into floppy drive and press Enter.
6. System will boot-up to DOS prompt.
7. Type "Awdflash xxxx.bf/sn/py/r" in DOS prompt.
(xxxx means BIOS name.)
8. System will update BIOS automatically and restart.
9. The BIOS has been recovered and will work properly.

PT880 Pro-A7 DDR2

B. CPU Overheated

If the system shutdown automatically after power on system for seconds, that means the CPU protection function has been activated.

When the CPU is over heated, the motherboard will shutdown automatically to avoid a damage of the CPU, and the system may not power on again.

In this case, please double check:

1. The CPU cooler surface is placed evenly with the CPU surface.
2. CPU fan is rotated normally.
3. CPU fan speed is fulfilling with the CPU speed.

After confirmed, please follow steps below to relief the CPU protection function.

1. Remove the power cord from power supply for seconds.
2. Wait for seconds.
3. Plug in the power cord and boot up the system.

Or you can:

1. Clear the CMOS data.
(See "Close CMOS Header: JCMOS1" section)
2. Wait for seconds.
3. Power on the system again.

PT880 Pro-A7 DDR2

4.3 TROUBLESHOOTING

Problem	Solution
<ol style="list-style-type: none"> 1. No power to the system at all. Power light don't illuminate, fan inside power supply does not turn on. 2. Indicator light on key board does not turn on. 	<ol style="list-style-type: none"> 1. Make sure power cable is securely plugged in. 2. Replace cable. 3. Contact technical support.
System inoperativ e. Keyboard lights are on, power indicator lights are lit, and hard driv e is spinning.	Using even pressure on both ends of the DIMM, press down firmly until the module snaps into place.
System does not boot from hard disk driv e, can be bootedf rom optical driv e.	<ol style="list-style-type: none"> 1. Check cable running from disk to disk controller board. Make sure both ends are securely plugged in; check the driv e type in the standard CMOS setup. 2. Backing up the hard drive is extremely important. All hard disks are capable of breaking down at any time.
System only boots f rom optical driv e. Hard disk can be read and applications can be used but booting from hard disk is impossible.	<ol style="list-style-type: none"> 1. Back up data and applications files. 2. Ref ormat the hard driv e. Re-install applications and data using backup disks.
Screen message says "Invalid Configuration" or "CMOS Failure."	Review system's equipment. Make sure correct inf ormation is in setup.
Cannot boot system after installing second hard driv e.	<ol style="list-style-type: none"> 1. Set master/slave jumpers correctly. 2. Run SETUP program and select correct driv e types. Call the drive manuf acturers f or compatibility with other drives.

CHAPTER 5: WARPSPEEDER™



5.1 INTRODUCTION

[WarpSpeeder™], a new powerful control utility, features three user-friendly functions including Overclock Manager, Overvoltage Manager, and Hardware Monitor.

With the Overclock Manager, users can easily adjust the frequency they prefer or they can get the best CPU performance with just one click. The Overvoltage Manager, on the other hand, helps to power up CPU core voltage and Memory voltage. The cool Hardware Monitor smartly indicates the temperatures, voltage and CPU fan speed as well as the chipset information. Also, in the About panel, you can get detail descriptions about BIOS model and chipsets. In addition, the frequency status of CPU, memory, AGP and PCI along with the CPU speed are synchronically shown on our main panel.

Moreover, to protect users' computer systems if the setting is not appropriate when testing and results in system fail or hang, [WarpSpeeder™] technology assures the system stability by automatically rebooting the computer and then restart to a speed that is either the original system speed or a suitable one.

5.2 SYSTEM REQUIREMENT

OS Support: Windows 98 SE, Windows Me, Windows 2000, Windows XP
DirectX: DirectX 8.1 or above. (The Windows XP operating system includes DirectX 8.1. If you use Windows XP, you do not need to install DirectX 8.1.)

PT880 Pro-A7 DDR2

5.3 INSTALLATION

1. Execute the setup execution file, and then the following dialog will pop up. Please click “Next” button and follow the default procedure to install.



2. When you see the following dialog in setup procedure, it means setup is completed. If the “Launch the WarpSpeeder Tray Utility” checkbox is checked, the Tray Icon utility and [WarpSpeeder™] utility will be automatically and immediately launched after you click “Finish” button.



Usage:

The following figures are just only for reference, the screen printed in this user manual will change according to your motherboard on hand.

PT880 Pro-A7 DDR2

5.4 [WARPSPEEDER™] INCLUDES 1 TRAY ICON AND 5 PANELS

1. Tray Icon:

Whenever the Tray Icon utility is launched, it will display a little tray icon on the right side of Windows Taskbar.

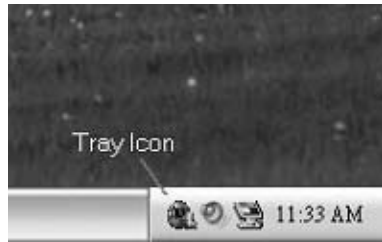

This utility is responsible for conveniently invoking [WarpSpeeder™] Utility. You can use the mouse by clicking the left button in order to invoke [WarpSpeeder™] directly from the little tray icon or you can right-click the little tray icon to pop up a popup menu as following figure. The "Launch Utility" item in the popup menu has the same function as mouse left-click on tray icon and "Exit" item will close Tray Icon utility if selected.



PT880 Pro-A7 DDR2

2. Main Panel

If you click the tray icon, [WarpSpeeder™] utility will be invoked.
Please refer to the following figure; the utility's first window you will see is Main Panel.

Main Panel contains features as follows:

- Display the CPU Speed, CPU external dock, Memory dock, AGP dock, and PCI dock information.
- Contains About, Voltage, Overclock, and Hardware Monitor Buttons for invoking respective panels.
- With a user-friendly Status Animation, it can represent 3 overclock percentage stages:
Man walking → overclock percentage from 100% ~ 110 %
Panther running → overclock percentage from 110% ~ 120%
Car racing → overclock percentage from 120% ~ above

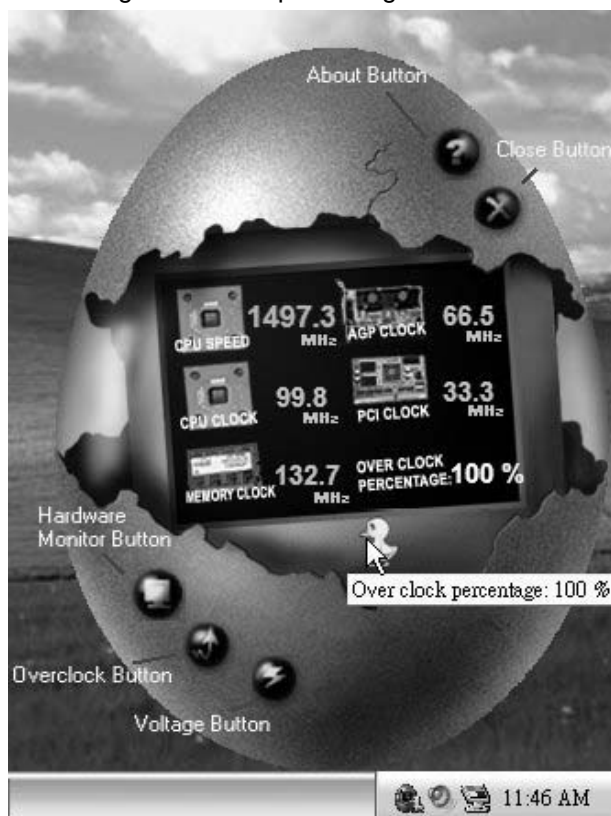

PT880 Pro-A7 DDR2

3. Voltage Panel

Click the Voltage button in Main Panel, the button will be highlighted and the Voltage Panel will slide out to up as the following figure.

In this panel, you can decide to increase CPU core voltage and Memory voltage or not. The default setting is "No". If you want to get the best performance of overlocking, we recommend you click the option "Yes".



PT880 Pro-A7 DDR2

4. Overclock Panel

Click the Overclock button in Main Panel, the button will be highlighted and the Overclock Panel will slide out to left as the following figure.



Overclock Panel contains the these features:

- “-3MHz button”, “-1MHz button”, “+1MHz button”, and “+3MHz button”:
provide user the ability to do real-time overclock adjustment.

Warning:

Manually overclock is potentially dangerous, especially when the overlocking percentage is over 110 %. We strongly recommend you verify every speed you overclock by click the Verify button. Or, you can just click Auto overclock button and let [WarpSpeeder™] automatically gets the best result for you.

- “Recovery Dialog button”:
Pop up the following dialog. Let user select a restoring way if system need to do a fail-safe reboot.



PT880 Pro-A7 DDR2

- c. “Auto-overclock button”: User can click this button and [WarpSpeeder™] will set the best and stable performance and frequency automatically. [WarpSpeeder™] utility will execute a series of testing until system fail. Then system will do fail-safe reboot by using Watchdog function. After reboot, the [WarpSpeeder™] utility will restore to the hardware default setting or load the verified best and stable frequency according to the Recovery Dialog’s setting.
- d. “Verify button”: User can click this button and [WarpSpeeder™] will proceed a testing for current frequency. If the testing is ok, then the current frequency will be saved into system registry. If the testing fail, system will do a fail-safe rebooting. After reboot, the [WarpSpeeder™] utility will restore to the hardware default setting or load the verified best and stable frequency according to the Recovery Dialog’s setting.

Note:

Because the testing programs, invoked in Auto-overclock and Verify, include DirectDraw, Direct3D and DirectShow tests, the DirectX 8.1 or newer runtime library is required. And please make sure your display card’s color depth is High color (16 bit) or True color (24/32 bit) that is required for Direct3D rendering.

5. Hardware Monitor Panel

Click the Hardware Monitor button in Main Panel, the button will be highlighted and the Hardware Monitor panel will slide out to left as the following figure.

In this panel, you can get the real-time status information of your system. The information will be refreshed every 1 second.



PT880 Pro-A7 DDR2

6. About Panel

Click the “about” button in Main Panel, the button will be highlighted and the About Panel will slide out to up as the following figure.

In this panel, you can get model name and detail information in hints of all the chipset that are related to overclocking. You can also get the mainboard’s BIOS model and the Version number of [WarpSpeeder™] utility.

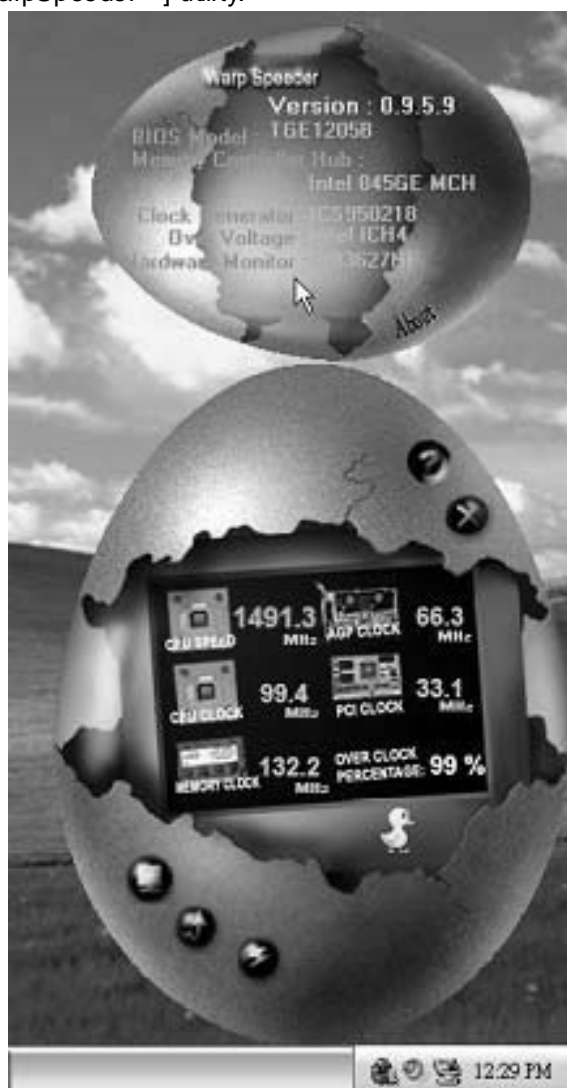

PT880 Pro-A7 DDR2

Note:

Because the overclock, overvoltage, and hardware monitor features are controlled by several separate chipset, [WarpSpeeder™] divide these features to separate panels. If one chipset is not on board, the correlative button in Main panel will be disabled, but will not interfere other panels' functions. This property can make [WarpSpeeder™] utility more robust.

PT880 Pro-A7 DDR2

APPENDIX:

CERTIFIED PCI-EXPRESS VGA CARD LIST

The following PCI-Express VGA Cards are certificated to work with this motherboard.

ASUS X300SE
ASUS X550GE
ASUS 5900
ELSA X850
ELSA X55
ELSA 6200
ELSA 6600
ELSA X700pro
ELSA 6600GT
Gigabyte X700
Gigabyte X800
MSI X800XL
MSI 5750
MSI X600
Nvidia 7800GT
Nvidia 7800GTX
Winfast 6800GT

PT880 Pro-A7 DDR2
BIOS Setup

BIOS Setup	1
1 Main Menu.....	3
2 Standard CMOS Features.....	6
3 Advanced BIOS Features.....	9
4 Advanced Chipset Features.....	16
5 Integrated Peripherals.....	22
6 Power Management Setup.....	27
7 PnP/PCI Configurations.....	33
8 PC Health Status.....	36
9 Frequency/ Voltage Control.....	38

BIOS Setup

Introduction

This manual discussed Award™ Setup program built into the ROM BIOS. The Setup program allows users to modify the basic system configuration. This special information is then stored in battery-backed RAM so that it retains the Setup information when the power is turned off.

The Award BIOS™ installed in your computer system's ROM (Read Only Memory) is a custom version of an industry standard BIOS. This means that it supports Intel Pentium® 4 processor input/output system. The BIOS provides critical low-level support for standard devices such as disk drives and serial and parallel ports.

Adding important has customized the Award BIOS™, but nonstandard, features such as virus and password protection as well as special support for detailed fine-tuning of the chipset controlling the entire system.

The rest of this manual is intended to guide you through the process of configuring your system using Setup.

Plug and Play Support

These AWARD BIOS supports the Plug and Play Version 1.0A specification. ESCD (Extended System Configuration Data) write is supported.

EPA Green PC Support

This AWARD BIOS supports Version 1.03 of the EPA Green PC specification.

APM Support

These AWARD BIOS supports Version 1.1&1.2 of the Advanced Power Management (APM) specification. Power management features are implemented via the System Management Interrupt (SMI). Sleep and Suspend power management modes are supported. Power to the hard disk drives and video monitors can be managed by this AWARD BIOS.

ACPI Support

Award ACPI BIOS support Version 1.0 of Advanced Configuration and Power interface specification (ACPI). It provides ASL code for power management and device configuration capabilities as defined in the ACPI specification, developed by Microsoft, Intel and Toshiba.

PT880 Pro-A7 DDR2

PCI Bus Support

This AWARD BIOS also supports Version 2.1 of the Intel PCI (Peripheral Component Interconnect) local bus specification.

DRAM Support

DDR2 SDRAM (Double Data Rate Two Synchronous DRAM) are supported.

Supported CPUs

This AWARD BIOS supports the Intel CPU.

Using Setup

In general, you use the arrow keys to highlight items, press <Enter> to select, use the <PgUp> and <PgDn> keys to change entries, press <F1> for help and press <Esc> to quit. The following table provides more detail about how to navigate in the Setup program by using the keyboard.

Keystroke	Function
Up arrow	Move to previous item
Down arrow	Move to next item
Left arrow	Move to the item on the left (menu bar)
Right arrow	Move to the item on the right (menu bar)
Move Enter	Move to the item you desired
PgUp key	Increase the numeric value or make changes
PgDn key	Decrease the numeric value or make changes
+ Key	Increase the numeric value or make changes
- Key	Decrease the numeric value or make changes
Esc key	Main Menu – Quit and not save changes into CMOS Status Page Setup Menu and Option Page Setup Menu – Exit Current page and return to Main Menu
F1 key	General help on Setup navigation keys
F5 key	Load previous values from CMOS
F7 key	Load the optimized defaults
F10 key	Save all the CMOS changes and exit

1 Main Menu

Once you enter Award BIOS™ CMOS Setup Utility, the Main Menu will appear on the screen. The Main Menu allows you to select from several setup functions. Use the arrow keys to select among the items and press <Enter> to accept and enter the sub-menu.

!! WARNING !!

The information about BIOS defaults on manual (**Figure 1,2,3,4,5,6,7,8,9**) is just for reference, please refer to the BIOS installed on board, for update information.

■ **Figure 1. Main Menu**

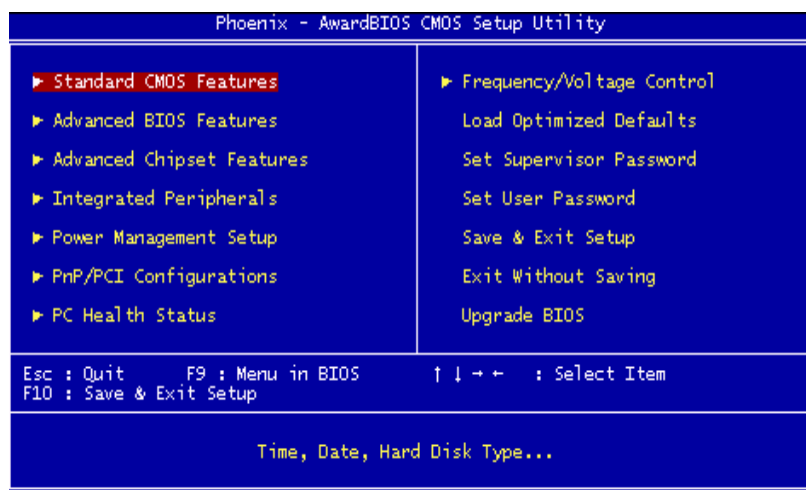

Standard CMOS Features

This submenu contains industry standard configurable options.

Advanced BIOS Features

This submenu allows you to configure enhanced features of the BIOS.

Advanced Chipset Features

This submenu allows you to configure special chipset features.

PT880 Pro-A7 DDR2

Integrated Peripherals

This submenu allows you to configure certain IDE hard drive options and Programmed Input/ Output features.

Power Management Setup

This submenu allows you to configure the power management features.

PnP/PCI Configurations

This submenu allows you to configure certain “Plug and Play” and PCI options.

PC Health Status

This submenu allows you to monitor the hardware of your system.

Frequency/ Voltage Control

This submenu allows you to change CPU Vcore Voltage and CPU/PCI clock. **(However, this function is strongly recommended not to use. Not properly change the voltage and clock may cause the CPU or M/B damage!)**

Load Optimized Defaults

This selection allows you to reload the BIOS when the system is having problems particularly with the boot sequence. These configurations are factory settings optimized for this system. A confirmation message will be displayed before defaults are set.



Load Optimized Defaults (Y/N)? N

Set Supervisor Password

Setting the supervisor password will prohibit everyone except the supervisor from making changes using the CMOS Setup Utility. You will be prompted with to enter a password.



Enter Password:

PT880 Pro-A7 DDR2

Set User Password

If the Supervisor Password is not set, then the User Password will function in the same way as the Supervisor Password. If the Supervisor Password is set and the User Password is set, the "User" will only be able to view configurations but will not be able to change them.

Enter Password:

Save & Exit Setup

Save all configuration changes to CMOS(memory) and exit setup. Confirmation message will be displayed before proceeding.

SAVE to CMOS and EXIT (Y/N)? Y

Exit Without Saving

Abandon all changes made during the current session and exit setup. Confirmation message will be displayed before proceeding.

Quit Without Saving (Y/N)? N

Upgrade BIOS

This submenu allows you to upgrade bios.

BIOS UPDATE UTILITY (Y/N)? N

2 Standard CMOS Features

The items in Standard CMOS Setup Menu are divided into 10 categories. Each category includes no, one or more than one setup items. Use the arrow keys to highlight the item and then use the <PgUp> or <PgDn> keys to select the value you want in each item.

■ Figure 2. Standard CMOS Setup

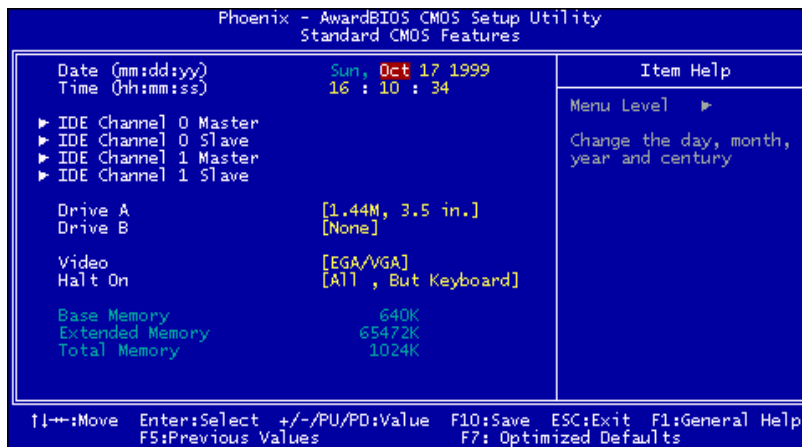

PT880 Pro-A7 DDR2

Main Menu Selections

This table shows the selections that you can make on the Main Menu.

Item	Options	Description
Date	mm : dd : yy	Set the system date. Note that the 'Day' automatically changes when you set the date.
Time	hh : mm : ss	Set the system internal clock.
IDE Primary Master	Options are in its sub menu.	Press <Enter> to enter the sub menu of detailed options
IDE Primary Slave	Options are in its sub menu.	Press <Enter> to enter the sub menu of detailed options.
IDE Secondary Master	Options are in its sub menu.	Press <Enter> to enter the sub menu of detailed options.
IDE Secondary Slave	Options are in its sub menu.	Press <Enter> to enter the sub menu of detailed options.
Drive A Drive B	360K, 5.25 in 1.2M, 5.25 in 720K, 3.5 in 1.44M, 3.5 in 2.88M, 3.5 in None	Select the type of floppy disk drive installed in your system.
Video	EGA/VGA CGA 40 CGA 80 MONO	Select the default video device.

PT880 Pro-A7 DDR2

Item	Options	Description
Halt On	All Errors No Errors All, but Keyboard All, but Diskette All, but Disk/ Key	Select the situation in which you want the BIOS to stop the POST process and notify you.
Base Memory	N/A	Displays the amount of conventional memory detected during boot up.
Extended Memory	N/A	Displays the amount of extended memory detected during boot up.
Total Memory	N/A	Displays the total memory available in the system.

3 Advanced BIOS Features

■ Figure 3. Advanced BIOS Setup

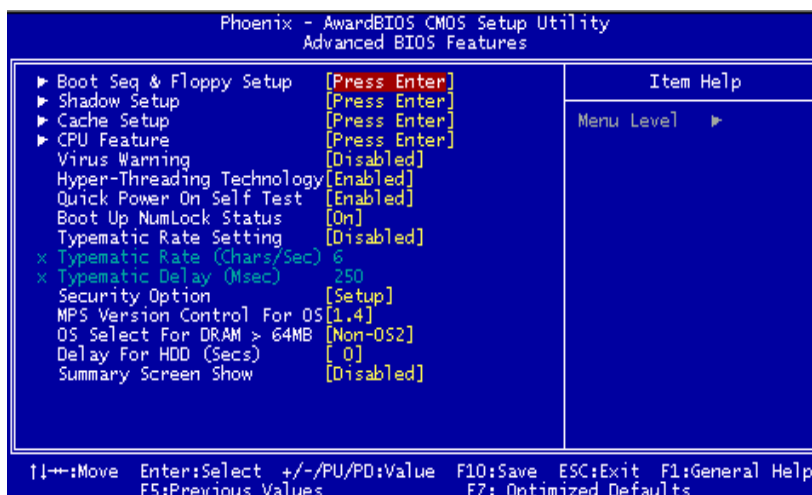

Boot Seq & Floppy Setup

This item allows you to setup boot seq & Floppy.

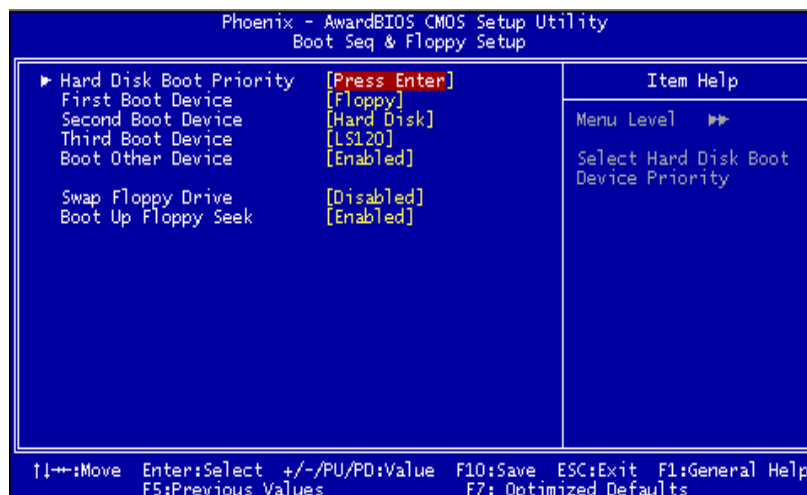

PT880 Pro-A7 DDR2

Hard Disk Boot Priority

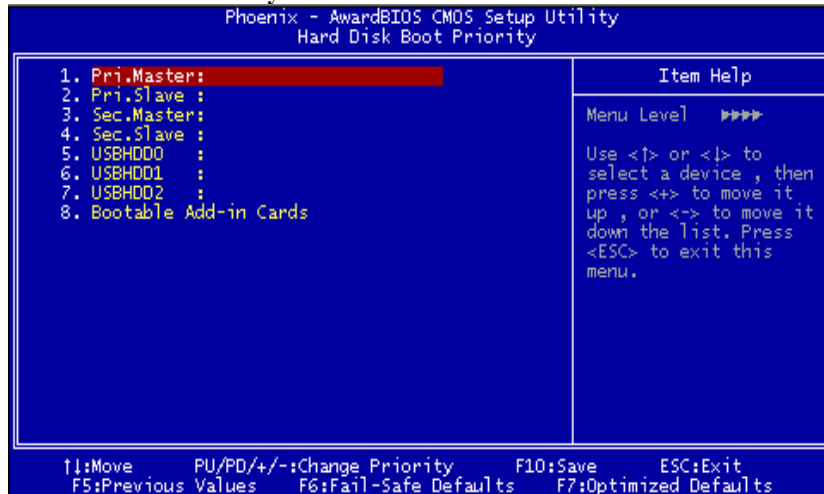

These BIOS attempt to load the operating system from the device in the sequence selected in these items.

The Choices: Pri. Master, Pri.Slave, Sec.Master, Sec. Slave, USBHDD0, USBHDD1, USBHDD2 and Bootable Add-in Cards.

First/ Second/ Third/ Boot Other Device

These BIOS attempt to load the operating system from the devices in the sequence selected in these items.

The Choices: Floppy, LS120, Hard Disk, CDROM, ZZP100, USB-FDD, USB-ZIP, USB-CDROM, LAN, Disabled.

Swap Floppy Drive

For systems with two floppy drives, this option allows you to swap logical drive assignments.

The Choices: Disabled (default), Enabled.

Boot Up Floppy Seek

Enabling this option will test the floppy drives to determine if they have 40 or 80 tracks. Disabling this option reduces the time it takes to boot-up.

The Choices: Enabled (default), Disabled.

PT880 Pro-A7 DDR2

Shadow Setup

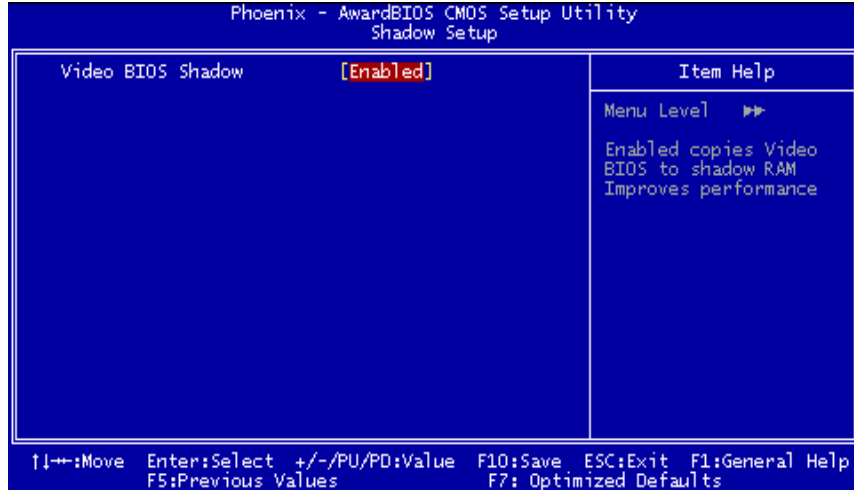

Video BIOS Shadow

Determines whether video BIOS will be copied to RAM for faster execution.

Enabled (default)

Optional ROM is enabled.

Disabled

Optional ROM is disabled.

Cache Setup

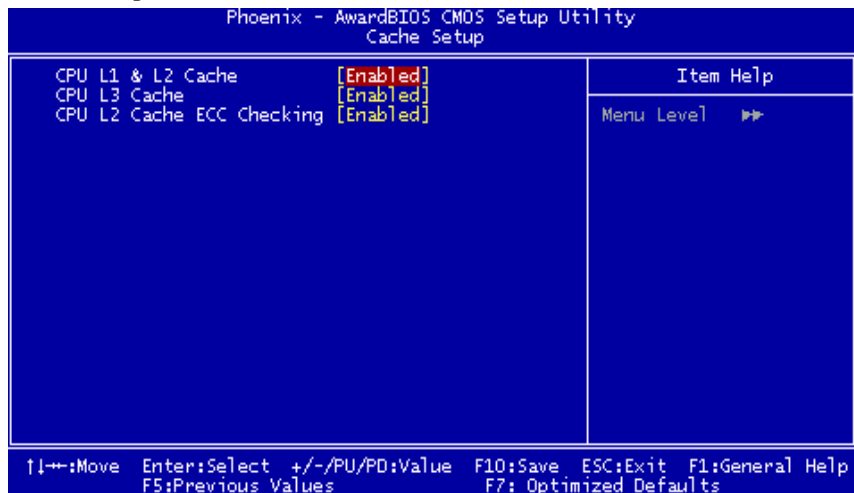

PT880 Pro-A7 DDR2

CPU L1&L2 Cache

Depending on the CPU/chipset in use, you may be able to increase memory access time with this option.

Enabled (default) Enable cache.
Disabled Disable cache.

CPU L3 Cache

(This item will be hidden if CPU L3 is absent.)

Depending on the CPU/chipset in use, you may be able to increase memory access time with this option.

Enabled (default) Enable cache.
Disabled Disable cache.

CPU L2 Cache ECC Checking

This item allows you to enable/disable CPU L2 Cache ECC Checking.

The Choices: Enabled (default), Disabled.

CPU FEATURE

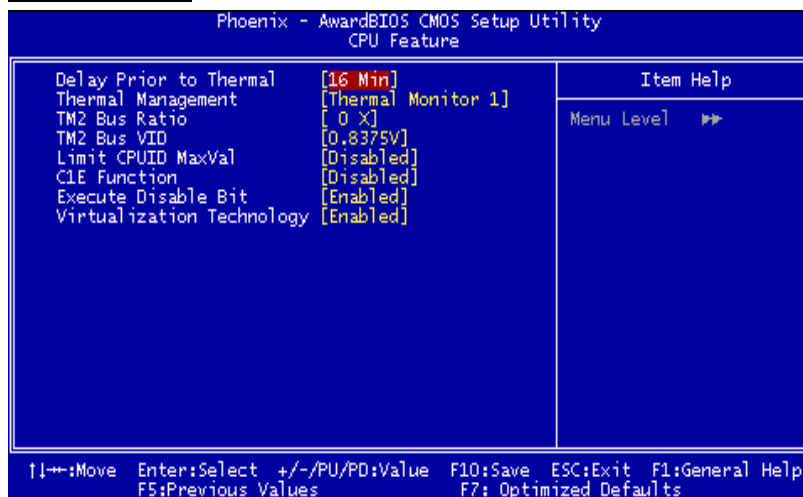

Delay Prior to Thermal

Set this item to enable the CPU Thermal function to engage after the specified time.

The Choices: 4, 8, 16 (default), 32.

Thermal Management

Allow you to choose the thermal management method of your monitor.

The Choices: Thermal Monitor 1 (default), Thermal Monitor2.

Notes: The choices will be different according to your CPU features.

PT880 Pro-A7 DDR2

TM2 Bus Ratio

Represents the frequency. Bus ratio of the throttled performance state that will be initiated when the on-die sensor goes from not hot to hot.

The Choices: **0X** (default).

TM2 Bus VID

Represents the voltage of the throttled performance state that will be initiated when the on-die sensor goes from not hot to hot.

The Choices: **0.8375** (default).

Limit CPU ID Max Val

Set limit CPU ID maximum vale to 3, it should be disabled for Win XP.

The Choices: **Disabled** (default), **Enabled**.

C1E Function

The Choices: **Disabled** (default), **Enabled**.

Execute Disable Bit

When disabled, forces the XD feature flag to always return 0.

The Choices: **Disabled**, **Enabled** (default).

Virtualization Technology

This option allows you to enable or disable Virtualization Technology if CPU supports it. VT will allow a platform to run multiple OS and applications in independent partitions.

The Choices: **Disabled**, **Enabled** (default).

Virus Warning

This option allows you to choose the Virus Warning feature that is used to protect the IDE Hard Disk boot sector. If this function is enabled and an attempt is made to write to the boot sector, BIOS will display a warning message on the screen and sound an alarm beep.

Disabled (default)	Virus protection is disabled.
Enabled	Virus protection is activated.

Hyper-Threading Technology

This option allows you to enable or disabled CPU Hyper-Threading. Enabled for Windows XP and Linux 2.4.x (OS optimized for Hyper Threading Technology. Disabled for other OS (OS not optimized for Hyper Threading Technology).

The Choices: **Enabled** (default), **Disabled**.

PT880 Pro-A7 DDR2

Quick Power On Self Test

Enabling this option will cause an abridged version of the Power On Self-Test (POST) to execute after you power up the computer.

Enabled (default)	Enable quick POST.
Disabled	Normal POST.

Boot Up NumLock Status

Selects the NumLock. State after power on.

On (default)	Numpad is number keys.
Off	Numpad is arrow keys.

Typematic Rate Setting

When a key is held down, the keystroke will repeat at a rate determined by the keyboard controller. When enabled, the typematic rate and typematic delay can be configured.

The Choices: Disabled (default), Enabled

Typematic Rate (Chars/Sec)

Sets the rate at which a keystroke is repeated when you hold the key down.

The Choices: 6 (default), 8,10,12,15,20,24,30.

Typematic Delay (Msec)

Sets the delay time after the key is held down before it begins to repeat the keystroke.

The Choices: 250 (default), 500, 750, 1000.

Security Option

This option will enable only individuals with passwords to bring the system online and/or to use the CMOS Setup Utility.

System	A password is required for the system to boot and is also required to access the Setup Utility.
Setup (default)	A password is required to access the Setup Utility only.

This will only apply if passwords are set from the Setup main menu.

MPS Version Control For OS

The BIOS supports version 1.1 and 1.4 of the Intel multiprocessor specification.

Select version supported by the operation system running on this computer.

The Choices: 1.4 (default), 1.1.

OS Select For DRAM > 64MB

A choice other than Non-OS2 is only used for OS2 systems with memory exceeding 64MB.

The Choices: Non-OS2 (default), OS2.

PT880 Pro-A7 DDR2

Delay for HDD

The Choices: 0 (default)

Summary Screen Show

This item allows you to enable/ disable display the Summary Screen Show.

The Choices: Disabled (default), Enabled.

4 Advanced Chipset Features

This submenu allows you to configure the specific features of the chipset installed on your system. This chipset manage bus speeds and access to system memory resources, such as DRAM. It also coordinates communications with the PCI bus. The default settings that came with your system have been optimized and therefore should not be changed unless you are suspicious that the settings have been changed incorrectly.

■ Figure 4. Advanced Chipset Setup

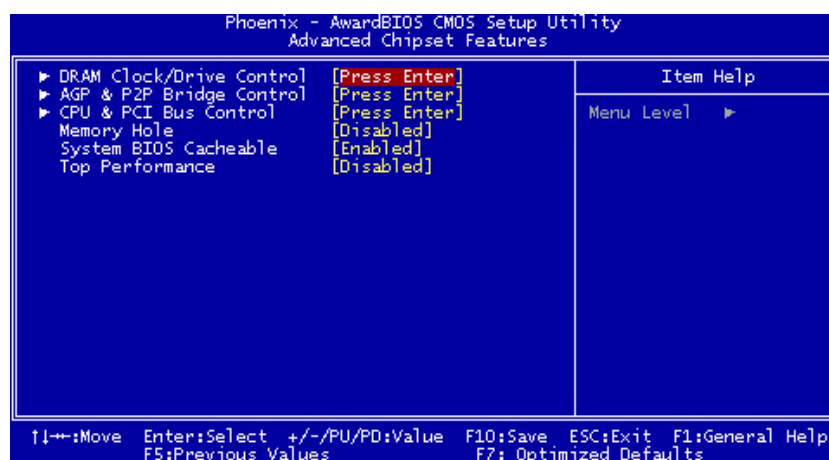

DRAM Clock/Drive Control

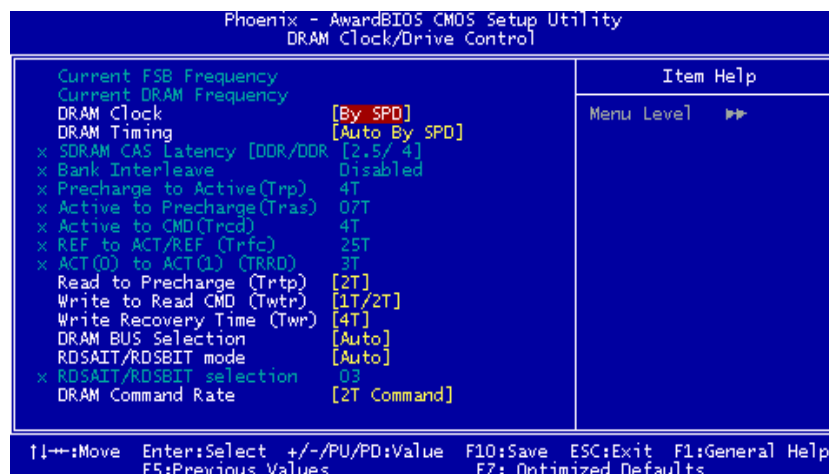

PT880 Pro-A7 DDR2

To control the Clock/Drive. If you highlight the literal “Press Enter” next to the “DRAM Clock/Drive Control” label and then press the enter key, it will take you a submenu with the following options:

DRAM Clock

This item determines DRAM clock following 100MHz, 133MHz, 166MHz, 200MHz, 266MHz, 333MHz or By SPD.

The Choices: 100MHz, 133MHz, **By SPD** (default), 166MHz, 200MHz, 266MHz, 333MHz.

DRAM Timing

This item determines DRAM clock/ timing follow SPD or not.

The Choices: Auto, **By SPD** (default), Manual, Turbo, Ultra.

SDRAM CAS Latency

When SDRAM is installed, the number of clock cycles of CAS latency depends on the SDRAM timing.

The Choices: 2, 3, 4, 5.

Bank Interleave

This item allows you to enable or disable the bank interleave feature.

The Choices: **Disabled (default)**, 2 bank, 4 bank, 8 bank.

Precharge to Active (Trp)

This item allows you to specify the delay from precharge command to activate command.

The Choices: 5T~20T.

Active to Precharge (Tras)

This item allows you to specify the minimum bank active time.

The Choices: 7T (default), 6T.

Active to CMD (Trcd)

Use this item to specify the delay from the activation of a bank to the time that a read or write command is accepted.

The Choices: 2T, 3T, **4T** (default), 5T.

REF to ACT/REF to REF (Trfc)

The Choices: 8~71T.

ACT (0) to ACT(1) (TRRD)

The Choices: 2T, 3T.

Read to Precharge <Trtp>

The Choices: 2T, 3T.

PT880 Pro-A7 DDR2

Write to Read <TWtr>

The Choices: 1T/2T, 2T/3T.

Write Recovery Time<TWr>

The Choices: 2T, 3T, 4T, 5T.

DRAM BUS Selection

The Choices: Auto (default), Single Channel, Dual Channel.

RDSAIT/RDSBIT Mode

The Choices: Auto (default), Manual.

RDSAIT/RDSBIT Selection

The Choices: 0~3F.

DRAM Command Rate

This item controls clock cycle that must occur between the last valid write operation and the next command.

The Choices: 1T Command, 2T Command (default).

AGP & P2P Bridge Control

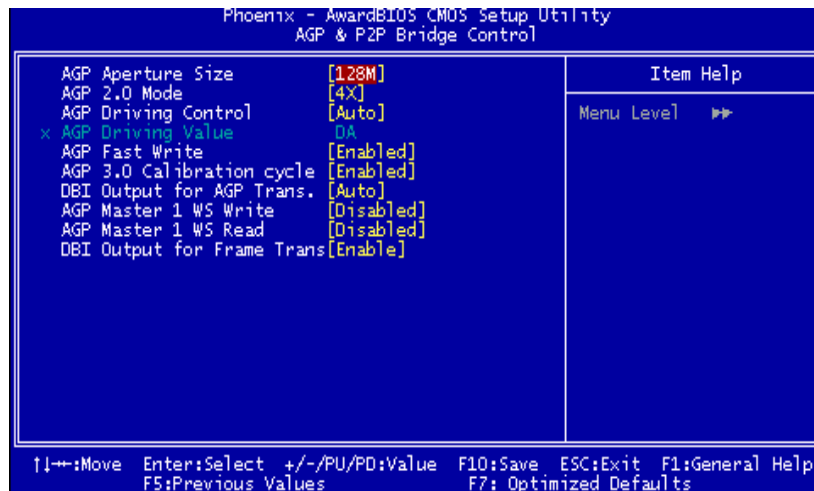

If you highlight the literal "Press Enter" next to the "AGP & P2P Bridge Control" label and then press the enter key, it will take you a submenu with the following options:

PT880 Pro-A7 DDR2

AGP Aperture Size

Select the size of the Accelerated Graphics Port (AGP) aperture. The aperture is a portion of the PCI memory address range dedicated for graphics memory address space. Host cycles that hit the aperture range are forwarded to the AGP without any translation.

The Choices: 64M, 256M, **128M** (default), 32M, 16M, 8M, 4M.

AGP 2.0 Mode

This item allows you to select the AGP Mode.

The Choices: **4X** (default), 2X, 1X.

AGP Driving Control

By choosing “Auto” the system BIOS will the AGP output Buffer Drive strength P Ctrl by AGP Card. By choosing “Manual”, it allows user to set AGP output Buffer Drive strength P Ctrl by manual.

The Choices: **Auto** (default), Manual.

AGP Driving Value

While AGP driving control item set to “Manual”, it allows user to set AGP driving.

The Choices: 0~FF.

AGP Fast Write

The Choices: **Enabled** (default), Disabled.

AGP 3.0 Calibration cycle

The Choices: **Enabled** (default), Disabled.

DBI Output for AGP Trans.

The Choices: **AUTO** (default).

AGP Master 1 WS Write

When Enabled, writes to the AGP (Accelerated Graphics Port) are executed with one-wait states.

The Choices: **Disabled** (default), Enabled.

AGP Master 1 WS Read

When Enabled, read to the AGP (Accelerated Graphics Port) are executed with one wait states.

The Choices: **Disabled** (default), Enabled.

DBI Output for Frame Trans.

The Choices: **Enabled** (default), Disabled.

PT880 Pro-A7 DDR2

CPU & PCI Bus Control

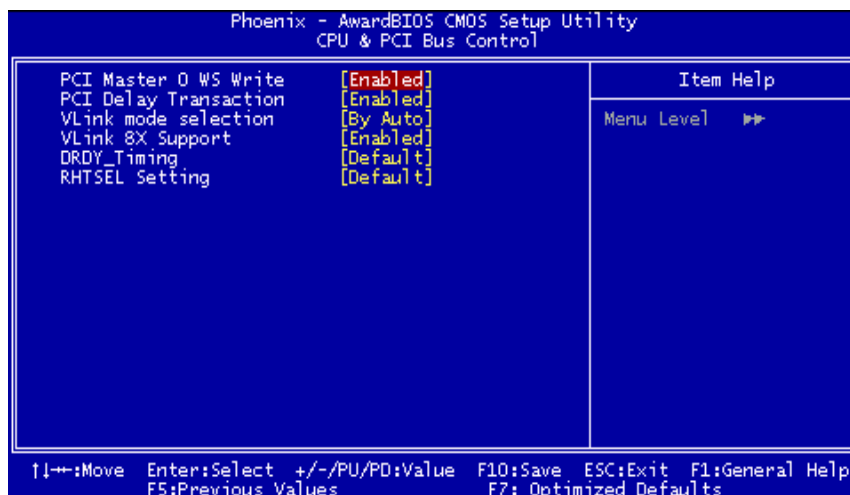

If you highlight the literal “Press Enter” next to the “CPU & PCI Bus Control” label and then press the enter key, it will take you a submenu with the following options:

PCI Master 0 WS Write

When enabled, writes to the PCI bus are executed with zero-wait states.

The Choices: Enabled (default), Disabled.

PCI Delay Transaction

The chipset has an embedded 32-bit posted write buffer to support delay transactions cycles. Select Enabled to support compliance with PCI specification.

The Choices: Enabled (default), Disabled.

Vlink mode selection

The Choices: By Auto (default), Mode0, Mode1, Mode2, Mode3, Mode4.

VLink 8X Support

This item allows you to enable or disable VLink 8X support.

The Choices: Enabled (default), Disabled.

DRDY-Timing

The Choices: Slowest, Default (default), Optimize.

RHTSEL Setting

The Choices: Default (default), Disabled, Enabled.

PT880 Pro-A7 DDR2

Memory Hole

When enabled, you can reserve an area of system memory for ISA adapter ROM. When this area is reserved, it cannot be cached. Refer to the user documentation of the peripheral you are installing for more information.

The Choices: **Disabled** (default), 15M – 16M.

System BIOS Cacheable

Selecting the “Enabled” option allows caching of the system BIOS ROM at F0000h-FFFFh, which can improve system performance. However, any programs writing to this area of memory will cause conflicts and result in system errors.

The Choices: **Enabled** (default), Disabled.

TOP Performance

This option allows you to enhance DRAM performance.

The Choices: **Disabled** (default), Enabled.

5 Integrated Peripherals

■ Figure 5. Integrated Peripherals

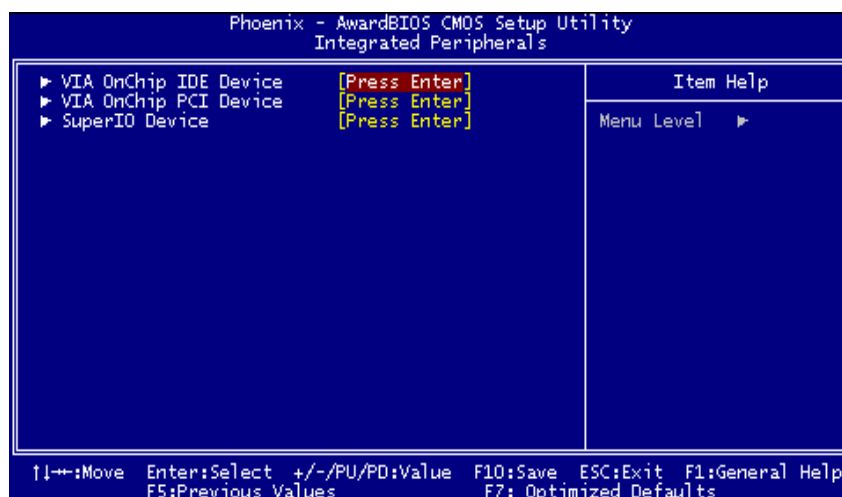

VIA OnChip IDE Device

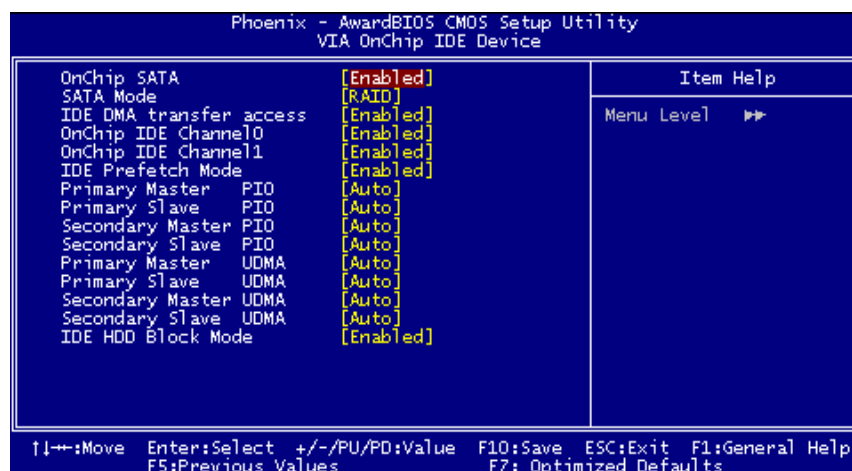

The chipset contains a PCI IDE interface with support for two IDE channels. Select "Enabled" to activate the first and / or second IDE interface. If you install a primary and / or secondary add-in IDE interface, select "Disabled" to deactivate an interface. If you highlight the literal "Press Enter" next to the "Onchip IDE Control" label and then press the enter key, it will take you a submenu with the following options:

PT880 Pro-A7 DDR2

OnChip SATA

This option allows you to enable the onchip Serial ATA.

The Choices: **Enabled** (default), Disabled.

SATA Mode

The Choices: IDE, **RAID** (default).

IDE DMA Transfer Access

The Choices: **Enabled** (default), Disabled.

OnChip IDE Channel 0/1

The motherboard chipset contains a PCI IDE interface with support for two IDE channels. Select "Enabled" to activate the first and/or second IDE interface. Select "Disabled" to deactivate an interface if you are going to install a primary and/or secondary add-in IDE interface.

The Choices: **Enabled** (default), Disabled.

IDE Prefetch Mode

The "onboard" IDE drive interfaces supports IDE prefetching for faster drive access. If the interface does not support prefetching. If you install a primary and/or secondary add-in IDE interface, set this option to "Disabled".

The Choices: **Enabled** (default), Disabled.

IDE Primary / Secondary Master / Slave PIO

The IDE PIO (Programmed Input / Output) fields let you set a PIO mode (0-4) for each of the IDE devices that the onboard IDE interface supports. Modes 0 through 4 provides successively increased performance. In Auto mode, the system automatically determines the best mode for each device.

The Choices: **Auto** (default), Mode0, Mode1, Mode2, Mode3, Mode4.

IDE Primary / Secondary Master / Slave UDMA

Ultra DMA/100 functionality can be implemented if it is supported by the IDE hard drives in your system. As well, your operating environment requires a DMA driver (Windows 95 OSR2 or a third party IDE bus master driver). If your hard drive and your system software both support Ultra DMA/100, select Auto to enable BIOS support.

The Choices: **Auto** (default), Disabled.

IDE HDD Block Mode

If your IDE hard drive supports block mode, select "Enabled" for automatic detection of the optimal number of block read/ writes per sector the drive can support.

The Choices: **Enabled** (default), Disabled.

PT880 Pro-A7 DDR2

VIA OnChip PCI Device

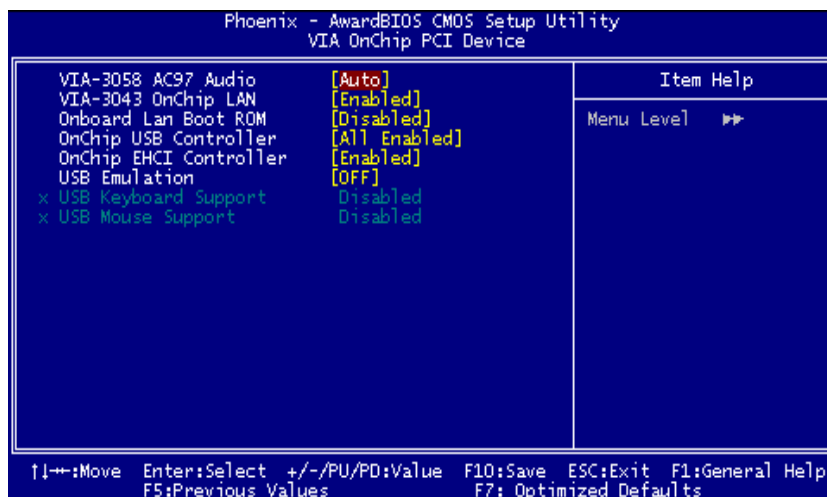

If you highlight the literal “Press Enter” next to the “OnChip PCI Device” label and then press the enter key, it will take you a submenu with the following options:

VIA-3058 AC97 Audio

This option allows you to control the onboard AC97 audio.

The Choices: Auto (default), Disabled.

VIA-3043 OnChip LAN

This option allows you to control the onboard LAN.

The Choices: Enabled (default), Disabled.

Onboard LAN Boot ROM

This item allows you to enable or disable Onboard LAN Boot ROM.

The Choices: Disabled (default), Enabled.

Onchip USB Controller

Select “Enabled” if your system contains a Universal Serial Bus (USB) controller and you have USB peripherals.

The Choices: All Enabled (default), All Disabled.

On-chip EHCI Controller

This item allows you to enable or disable the on-chip EHCI controller.

The Choices: Enabled (default), Disabled.

PT880 Pro-A7 DDR2

USB Emulation

The Choices: OFF (default), KB/MS, ON.

OFF Don't support any USB device on DOS.

KB/MS Support USB legacy KB and mouse, no support USB storage.

ON Support USB legacy keyboard, mouse and storage.

USB Keyboard/ Mouse Support

This item allows you to enable or disable the USB Keyboard/ Mouse Legacy Support.

The Choices: Disabled (default), Enabled.

Super IO Device



If you highlight the literal "Press Enter" next to the "Super IO Device" label and then press the enter key, it will take you a submenu with the following options:

Onboard FDC Controller

Select Enabled if your system has a floppy disk controller (FDC) installed on the system board and you wish to use it. If install and FDC or the system has no floppy drive, select Disabled in this field.

The Choices: Enabled (default), Disabled.

Onboard Serial Port 1

Select an address and corresponding interrupt for the first and second serial ports.

The Choices: Disabled, 3F8/IRQ4 (default), 2F8/IRQ3, 3E8/IRQ4, 2E8/IRQ3, Auto.

PT880 Pro-A7 DDR2

Onboard Parallel Port

This item allows you to determine access onboard parallel port controller with which I/O Address.

The Choices: 378/IRQ7 (default), 278/IRQ5, 3BC/IRQ7, Disabled.

Parallel Port Mode

The default value is SPP.

The Choices:

SPP (default)	Using Parallel port as Standard Printer Port.
EPP	Using Parallel Port as Enhanced Parallel Port.
ECP	Using Parallel port as Extended Capabilities Port.
ECP+EPP	Using Parallel port as ECP & EPP mode.

ECP Mode Use DMA

Select a DMA Channel for the port.

The Choices: 3 (default), 1.

6 Power Management Setup

The Power Management Setup Menu allows you to configure your system to utilize energy conservation and power up/power down features.

■ Figure 6. Power Management Setup

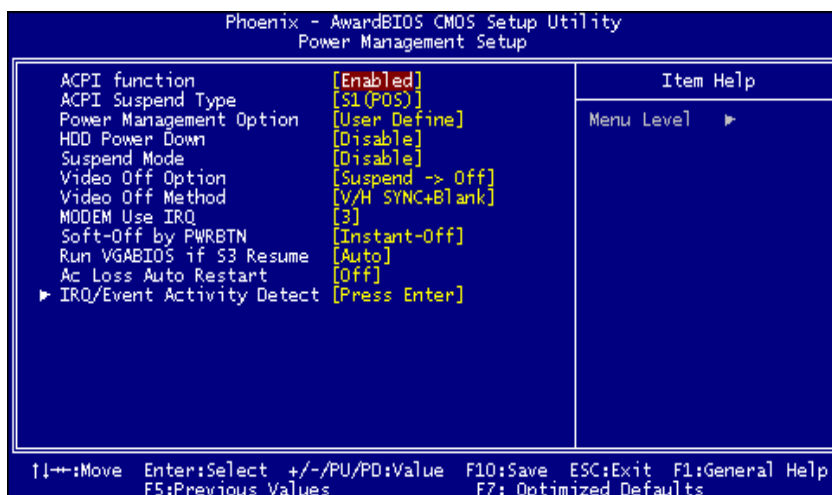

ACPI function

This item displays the status of the Advanced Configuration and Power Management (ACPI).

The Choices: Enabled (default), Disabled.

ACPI Suspend Type

The item allows you to select the suspend type under the ACPI operating system.

The Choices: S1 (POS) (default) Power on Suspend
S3 (STR) Suspend to RAM
S1+S3 POS+STR

Power Management

This category allows you to select the type (or degree) of power saving and is directly related to the following modes:

- 1.HDD Power Down.
- 2.Suspend Mode.

PT880 Pro-A7 DDR2

There are four options of Power Management, three of which have fixed mode settings

Min. Power Saving

Minimum power management.
Suspend Mode = 1 hr.
HDD Power Down = 15 min

Max. Power Saving

Maximum power management only available for sl CPU's.
Suspend Mode = 1 min.
HDD Power Down = 1 min.

User Define (default)

Allows you to set each mode individually.
When not disabled, each of the ranges is from 1 min. to 1 hr. except for HDD Power Down which ranges from 1 min. to 15 min. and disable.

HDD Power Down

When enabled, the hard disk drive will power down and after a set time of system inactivity. All other devices remain active.

The Choices: Disabled (default), 1 Min, 2 Min, 3 Min, 4 Min, 5 Min, 6 Min, 7 Min, 8 Min, 9 Min, 10 Min, 11 Min, 12 Min, 13 Min, 14 Min, 15Min.

Suspend Mode

The item allows you to select the suspend type under ACPI operating system.

The Choices: Disabled (default), 1 Min, 2 Min, 4 Min, 6 Min, 8 Min, 10 Min, 20 Min, 30 Min, 40 Min, 1 Hour.

Video Off Option

This field determines when to activate the video off feature for monitor power management.

The Choices: Suspend→Off (default), Always on.

PT880 Pro-A7 DDR2

Video Off Method

This option determines the manner in which the monitor is goes blank.

V/H SYNC+Blank (default)

This selection will cause the system to turn off the vertical and horizontal synchronization ports and write blanks to the video buffer.

Blank Screen

This option only writes blanks to the video buffer.

DPMS

Initial display power management signaling.

The Choices: Stop Grant, PwrOn Suspend.

Modem Use IRQ

This determines the IRQ, which can be applied in MODEM use.

The Choices: 3 (default), 4 / 5 / 7 / 9 / 10 / 11 / NA.

Soft-Off by PWR-BTTN

Pressing the power button for more than 4 seconds forces the system to enter the Soft-Off state when the system has “hung.”

The Choices: Delay 4 Sec, Instant-Off (default).

Run VGABIOS if S3 Resume

Choosing Enabled will make BIOS run VGA BIOS to initialize the VGA card when system wakes up from S3 state. The system time is shortened if you disable the function , but system will need AGP driver to initialize the card . So , if the AGP driver of the VGA card does not support the initialization feature , the display may work abnormally or not function after S3 .

The Choices: Auto (default), Yes, No.

Ac Loss Auto Restart

This field determines the action the system will automatically take when power is restored to a system that had lost power previously without any subsequent manual intervention.

There are 3 sources that provide current to the CMOS area that retains these Power-On instructions; the motherboard battery (3V), the Power Supply (5VSB), and the Power Supply (3.3V). While AC is not supplying power, the motherboard uses the motherboard battery (3V). If AC power is supplied and the Power Supply is not turned on, 5VSB from the Power Supply is used. When the Power Supply is eventually turned on 3.3V from the Power Supply will be used.

PT880 Pro-A7 DDR2

There are 3 options: “Former-Sts”, “On”, “Off”.

- “Off” (default) Means always set CMOS to the “Off” status when AC power is lost.
- “On” Means always set CMOS to the “On” status when AC power is lost
- “Former-Sts” Means to maintain the last status of the CMOS when AC power is lost.

For example: If set to “Former-Sts” and AC power is lost when system is live, then after AC power is restored, the system will automatically power on. If AC power is lost when system is not live, system will remain powered off.

IRQ/Event Activity Detect

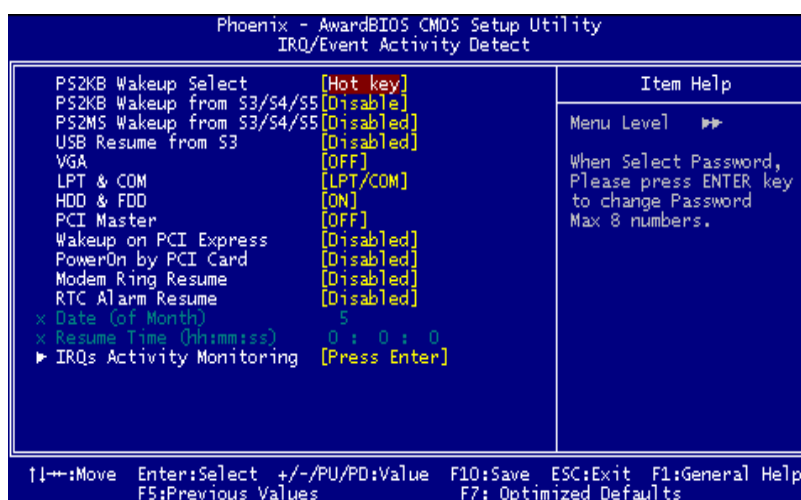

If you highlight the literal “Press Enter” next to the “IRQ/Event Activity Detect” label and then press the enter key, it will take you a submenu with the following options:

PS2KB Wakeup Select

When select Password, please press Enter key to change password with a maximum of 8 characters.

The Choices: Hot Key (default), Password.

PS2KB Wakeup from S3/ S4/ S5

This item allows you to wake up from S3/ S4/ S5 with PS2 keyboard.

The Choices: Disable (default), Ctrl+F1, Ctrl+F2, Ctrl+F3, Ctrl+F4, Ctrl+F5, Ctrl+F6, Ctrl+F7, Ctrl+F8, Ctrl+F9, Ctrl+F10, Ctrl+F11, Ctrl+F12, Power, Wake, Any Key.

PS2MS Wakeup from S3/ S4/ S5

This item allows you to wake up from S3/ S4/ S5 with PS2 mouse.

The Choices: Disabled (default), Enables.

PT880 Pro-A7 DDR2

USB Resume from S3

This item allows you to enable or disabled USB resume from S3.

The Choices: **Disabled** (default), Enabled.

VGA

When set to **On**, any event occurring at a VGA Port will awaken a system which has been powered down.

The Choices: **Off** (default), On.

LPT & COM

When this option is set to **On**, any event occurring at a COM (serial)/LPT (printer) port will awaken a system which has been powered down.

The Choices: **LPT/COM** (default), COM, LPT, NONE.

HDD & FDD

When this option is set to **On**, any event occurring on a hard drive or a floppy drive will awaken a system which has been powered down.

The Choices: **On** (default), Off.

PCI Master

When set to **On**, you need a LAN add-on card which supports the power function. It should also support the wake-up on LAN jump.

The Choices: **Off** (default), On.

Wake Up On PCI Express

The Choices: **Disabled** (default), Enabled.

Power On by PCI Card

When you select Enabled, a PME signal from PCI card returns the system to Full ON state.

The Choices: **Disabled** (default), Enabled.

Modem Ring Resume

The Choices: **Disabled** (default), Enabled.

RTC Alarm Resume

When "Enabled", you can set the date and time at which the RTC (real-time clock) alarm awakens the system from Suspend mode.

The Choices: Enabled, **Disabled** (default).

Date (of Month)

You can choose which month the system will boot up. This field is only configurable when "RTC Resume" is set to "Enabled"

PT880 Pro-A7 DDR2

Resume Time (hh:mm:ss)

You can choose the hour, minute and second the system will boot up.
This field is only configurable when “RTC Resume” is set to “Enabled”.

IRQs Activity Monitoring

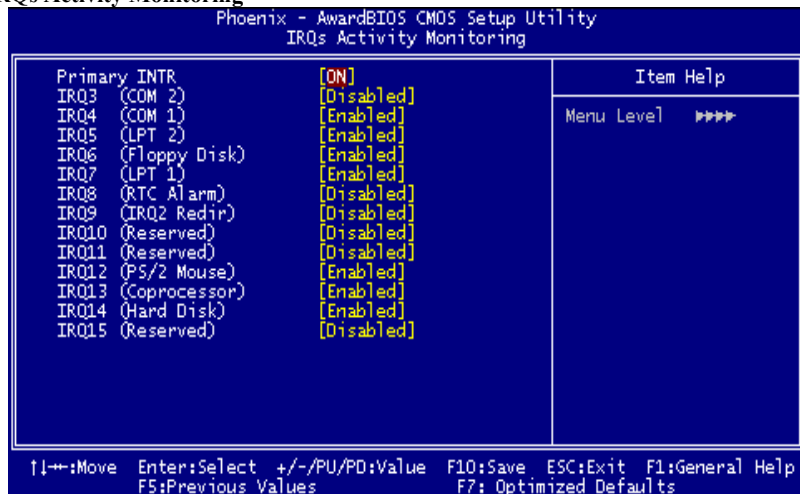

Press **Enter** to access another sub menu used to configure the different wake up events (i.e. wake on LPT & COMM activity).

Primary INTR	On
IRQ3 (COM2)	Enabled
IRQ4 (COM1)	Enabled
IRQ5 (LPT2)	Enabled
IRQ6 (Floppy Disk)	Enabled
IRQ7 (LPT1)	Enabled
IRQ8 (RTC Alarm)	Disabled
IRQ9 (IRQ2 Redir)	Disabled
IRQ10 (Reserved)	Disabled
IRQ11 (Reserved)	Disabled
IRQ12 (PS/2 Mouse)	Enabled
IRQ13 (Coprocessor)	Enabled
IRQ14 (Hard Disk)	Enabled
IRQ15 (Reserved)	Disabled

7 PnP/PCI Configurations

This section describes configuring the PCI bus system. PCI, or Personal Computer Interconnect, is a system which allows I/O devices to operate at speeds nearing the speed of the CPU itself uses when communicating with its own special components. This section covers some very technical items and it is strongly recommended that only experienced users should make any changes to the default settings.

■ Figure 7. PnP/PCI Configurations

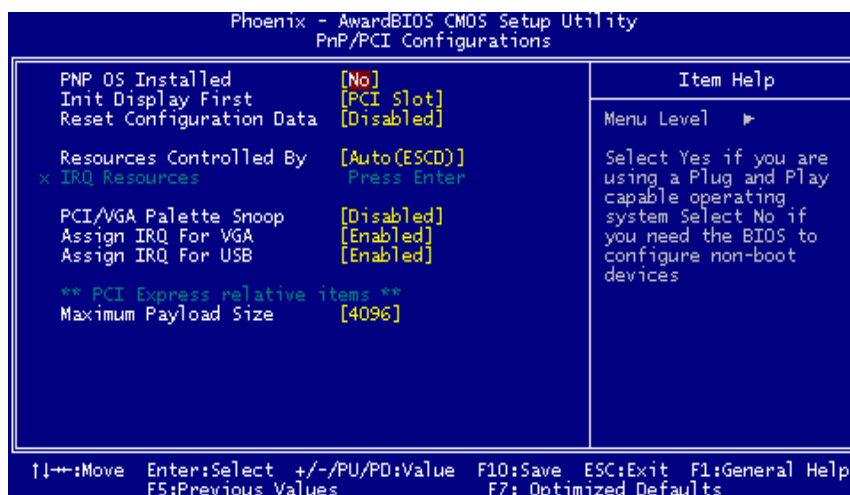

PNP OS Installed

When set to YES, BIOS will only initialize the PnP cards used for the boot sequence (VGA, IDE, SCSI). The rest of the cards will be initialized by the PnP operating system like Window™ 95. When set to NO, BIOS will initialize all the PnP cards. For non-PnP operating systems (DOS, Netware™), this option must set to NO.

The Choices: No (default), Yes.

INIT DISPLAY FIRST

With systems that have multiple video cards, this option determines whether the primary display uses a PCI Slot or an AGP Slot.

The Choices: PCI Slot (default), AGP, PCIEx.

PT880 Pro-A7 DDR2

Reset Configuration Data

The system BIOS supports the PnP feature which requires the system to record which resources are assigned and protects resources from conflict. Every peripheral device has a node, which is called ESCD. This node records which resources are assigned to it. The system needs to record and update ESCD to the memory locations. These locations (4K) are reserved in the system BIOS. If the Disabled (default) option is chosen, the system's ESCD will update only when the new configuration varies from the last one. If the Enabled option is chosen, the system is forced to update ESCDs and then is automatically set to the "Disabled" mode.

The above settings will be shown on the screen only if "Manual" is chosen for the resources controlled by function.

Legacy is the term, which signifies that a resource is assigned to the ISA Bus and provides non-PnP ISA add-on cards. PCI / ISA PnP signifies that a resource is assigned to the PCI Bus or provides for ISA PnP add-on cards and peripherals.

The Choices: Disabled (default), Enabled.

Resources Controlled By

By Choosing "**Auto(ESCD)**" (default), the system BIOS will detect the system resources and automatically assign the relative IRQ and DMA channel for each peripheral. By Choosing "Manual", the user will need to assign IRQ & DMA for add-on cards. Be sure that there are no IRQ/DMA and I/O port conflicts.

IRQ Resources

This submenu will allow you to assign each system interrupt a type, depending on the type of device using the interrupt. When you press the "Press Enter" tag, you will be directed to a submenu that will allow you to configure the system interrupts. This is only configurable when "Resources Controlled By" is set to "Manual".

IRQ-3	assigned to	PCI Device
IRQ-4	assigned to	PCI Device
IRQ-5	assigned to	PCI Device
IRQ-7	assigned to	PCI Device
IRQ-9	assigned to	PCI Device
IRQ-10	assigned to	PCI Device
IRQ-11	assigned to	PCI Device
IRQ-12	assigned to	PCI Device
IRQ-14	assigned to	PCI Device
IRQ-15	assigned to	PCI Device

PT880 Pro-A7 DDR2

PCI / VGA Palette Snoop

Choose Disabled or Enabled. Some graphic controllers which are not VGA compatible take the output from a VGA controller and map it to their display as a way to provide boot information and VGA compatibility.

However, the color information coming from the VGA controller is drawn from the palette table inside the VGA controller to generate the proper colors, and the graphic controller needs to know what is in the palette of the VGA controller. To do this, the non-VGA graphic controller watches for the Write access to the VGA palette and registers the snoop data. In PCI based systems, where the VGA controller is on the PCI bus and a non-VGA graphic controller is on an ISA bus, the Write Access to the palette will not show up on the ISA bus if the PCI VGA controller responds to the Write.

In this case, the PCI VGA controller should not respond to the Write, it should only snoop the data and permit the access to be forwarded to the ISA bus. The non-VGA ISA graphic controller can then snoop the data on the ISA bus. Unless you have the above situation, you should disable this option.

Disabled (default)	Disables the function.
Enabled	Enables the function.

Assign IRQ For VGA

This item allows the users to choose which IRQ to assign for the VGA.

The Choices: Enabled (default), Disabled.

Assign IRQ For USB

This item allows the users to choose which IRQ to assign for the USB.

The Choices: Enabled (default), Disabled.

PCI EXPRESS RELATIVE ITEMS

Maximum Payload Size

Set the maximum payload size for Transaction packets (TLP).

The Choice: 4096 (default.)

8 PC Health Status

■ Figure 8. PC Health Status

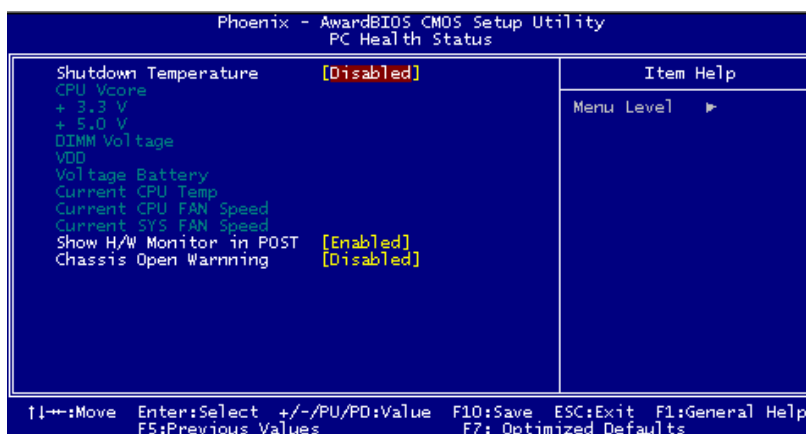

Shutdown Temperature

This item allows you to set up the CPU shutdown Temperature. This item only effective under Windows 98 ACPI mode.

The Choices: Disabled (default), 60°C/140F, 65°C/149F, 70°C/158F, 75°C/167F.

CPU Vcore/ +3.3V/ +5.0V/ DIMM Voltage/ VDD/ Voltage Battery

Detect the system's voltage status automatically.

Current CPU Temperature

This field displays the current temperature of the CPU.

Current CPU FAN Speed

This field displays the current speed of CPU fan.

Current SYS FAN Speed

This field displays the current speed SYSTEM fan.

Show H/W Monitor in POST

If your computer contains a monitoring system, it will show PC health status during POST

PT880 Pro-A7 DDR2

stage. The item offers several delay time for you to choose.
The Choices: **Enabled** (default), Disabled.

Chassis Open Warning

This item allows you to enable or disable Chassis Open Warning beep.
The Choices: **Disabled** (default), Enabled.

9 Frequency/ Voltage Control

■ Figure 9. Frequency/ Voltage Control

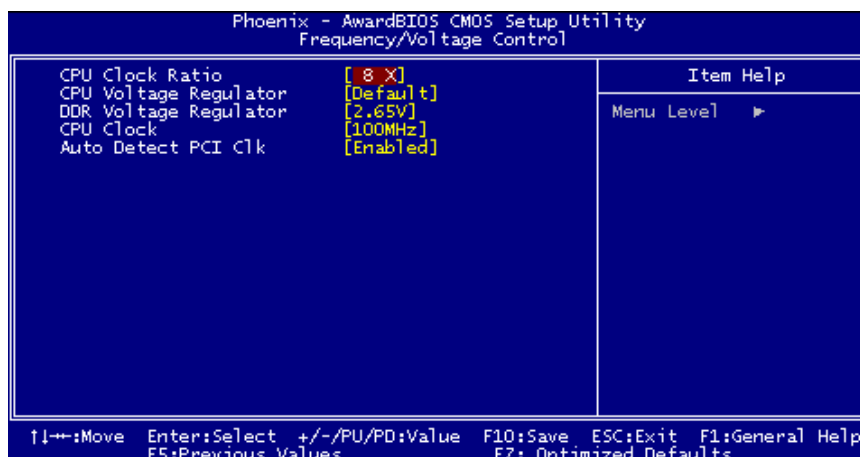

CPU CLOCK RATIO

The Choices: 8X (default), 9X, 10X, 11X, 12X, 13X, 14 X, 15X, 16X, 17X, 18X, 19X, 20 X, 21 X, 22 X, and 23X.

CPU Voltage Regulator

This item allows you to select CPU Voltage Control.

The Choices: Default (default)

DDR Voltage Regulator

This item allows you to select DDR Voltage Control.

The Choices: 1.8V, 1.9V, 2.0V, 2.1V.

CPU Clock

This item allows you to select CPU Clock, and CPU over clocking.



If unfortunately, the system's frequency that you are selected is not functioning, there are two methods of booting-up the system.

Method 1: Clear the COMS data by setting the JCOMS1 ((2-3) closed)) as "ON" status. All the CMOS data will be loaded as defaults setting.

Method 2: Press the <Insert> key and Power button simultaneously, after that keep-on pressing the <Insert> key until the power-on screen showed. This action will boot-up the system according to FSB of the processor.

※ It's strongly recommended to set CPU Vcore and clock in default setting. If the CPU Vcore and clock are not in default setting, it may cause CPU or M/B damage.

PT880 Pro-A7 DDR2

Auto Detect PCI/DIMM CLK

This item allows you to enable / disable auto Detect PCI Clock.

The Choices: Enabled (default), Disabled.