

# Presario 2200/4200

| Processor Boards                    | Assembly   | Spare Part                          | System  |
|-------------------------------------|------------|-------------------------------------|---|
| Board, Proc, w/ 16 MB RAM/ 2MB VRAM | 327068-101 | 327149-001                          | 2240, 44ES  |
| Board, Proc, w/ 16 MB RAM/ 1MB VRAM | 327068-102 | 327149-002                          | 2240, 46 (US, LA, Brazil only)                            |
| Board, Proc, w/ 32 MB, w/ 2 MB      | 310198-101 | 319208-001                          | 2253, 54, 55, 56  |
| Board, Proc, ES                     |            | 319277-001                          | 4240ES  |
| Board, Processor, w/o Processor     |            | 337362-001                          | 2256, 57, 58, 60, 62, 64, 66, 68, 70, 74, 75, 76, 78      |
| Board, Processor, w/o Processor     |            | 387610-001                          | 2281, 82, 83, 84, 85V, 86, 88, 89, 90, 92, 93, 94, 95, 97 |
| Board, Proc, 166MGX                 |            | 292535-001 (LA)<br>292536-001 (Dom) | 2200, 12ES  |
| Board, Proc, 180MGX                 |            | 292536-001                          | 2200, 10, 12  |
| Board, Proc, 200MGX                 |            | 292538-001                          | 2230, 32  |
| Board, Proc, 586                    |            | 292598-001                          | 4220, 12ES, 22  |
| Board, Proc, 686, 512K              | 310128-101 | 311009-001                          | 4230ES  |

## Jumper Settings, Presario 2200

| CPU Clock Multiplier | JP1      | JP2  | JP2 | JP3         | JP4  |
|----------------------|----------|--|-----|-------------|------|
| 233                  | OPEN     | 2-3  | 1-2 | 5-6 (3.2V)  | OPEN |
| 266                  | 1-2, 5-6 | 2-3  | 1-2 | OPEN (3.2V) | 3-4  |
| Configuration Jumper | Clear    |  |     |             |      |
|                      | 1 – 2    | Keep configuration info (CMOS) when power is off |     |             |      |
|                      | 2 – 3    | Clear config info when power is off              |     |             |      |

## Jumper Settings, Presario 4200

| CPU Clock Multiplier | Freq 1  | Freq 2   | Processor          |
|----------------------|---------|--|--------------------|
| 3.5x                 | 1 – 2   | 1 – 2  | 233                |
| 3x                   | 1 – 2   | 2 – 3  | 200                |
| 2.5x                 | 2 – 3   | 2 – 3  | 150, 166           |
| 2x                   | 2 – 3   | 1 – 2  | 120, 133           |
| Clock Speed          | CLK1    | CLK2   | Processor          |
| 66                   | 2 – 3   | 2 – 3  | 133, 166, 200, 233 |
| 60                   | 1 – 2   | 1 – 2  | 120, 150           |
| Configuration Jumper | Clear 1 |  |                    |
|                      | 1 – 2   | Keep configuration info (CMOS) when power is off |                    |
|                      | 2 – 3   | Clear config. info when power is off             |                    |

## Jumper Settings, Presario 4230ES

| CPU Clock Multiplier | JP1      | JP2  | JP3 |
|----------------------|----------|--|-----|
| 233                  | OFF      | ON   | ON  |
| 266                  | ON       | OFF  | OFF |
| 300                  | ON       | OFF  | ON  |
| 333                  | ON       | ON   | OFF |
| Configuration Jumper | Settings | Description                                      |     |
| J17                  | 1 – 2    | Keep configuration info (CMOS) when power is off |     |
|                      | 2 – 3    | Clear config. info when power is off             |     |

# Presario 2200/4200

## Jumper Settings, Presario 4240ES

| CPU Clock Multiplier | JP1      | JP2 | JP2 | JP3         | JP4  |
|----------------------|----------|-----|-----|-------------|------|
| 233                  | OPEN     | 2-3 | 1-2 | 5-6 (3.2V)  | OPEN |
| 266                  | 1-2, 5-6 | 2-3 | 1-2 | OPEN (3.2V) | 3-4  |

| Configuration Codes | System Board or Processor Board Spare Part | Model    |
|---------------------|--|----------|
| BP62                | 292598-001                                 | 4220     |
| BP63                | 292598-001                                 | 4220     |
| BP64                | 292598-001                                 | 4222     |
| BP65                | 292598-001                                 | 4220     |
| BP72                | 292536-001                                 | 2200     |
| BP73                | 292536-001                                 | 2200     |
| BP82                | 292536-001                                 | 2210     |
| BP83                | 292536-001                                 | 2210     |
| BP6N                | 292598-001                                 | 4212ES   |
| BP8C                | 292536-001                                 | 2212     |
| BP8M                | 292536-001                                 | 2210     |
| BQQ2                | 311009-001                                 | 4230ES   |
| BTF2                | 319277-001                                 | 4240ES   |
| BTS2                | 327149-002                                 | 2246     |
| BTT6                | 327149-001                                 | 2240     |
| BTT7                | 327149-001                                 | 2240     |
| BTT8                | 327149-001                                 | 2240     |
| BTT9                | 327149-001                                 | 2240     |
| BTTC                | 327149-001                                 | 2244ES   |
| BTTD                | 327149-002                                 | 2240     |
| BTTF                | 327149-001                                 | 2240     |
| BTTG                | 327149-002                                 | 2240     |
| BTTH                | 327149-001                                 | 2240     |
| BTTJ                | 327149-001                                 | 2240     |
| BXRB                | 319208-001                                 | 2254     |
| BXRJ                | 319208-001                                 | 2254     |
| BXRF                | 319208-001                                 | 2253     |
| BXRF                | 319208-001                                 | 2254     |
| BXRG                | 319208-001                                 | 2255     |
| BXRH                | 319208-001                                 | 2255     |
| BXRJ                | 319208-001                                 | 2255     |
| BXR2                | 319208-001                                 | 2254     |
| BXR4                | 319208-001                                 | 2254     |
| BXR6                | 319208-001                                 | 2254     |
| BXR7                | 319208-001                                 | 2254     |
| BXR8                | 319208-001                                 | 2254     |
| BXR9                | 319208-001                                 | 2253     |
| BXS2                | 319208-001                                 | 2256     |
| BXS3                | 319208-001                                 | 2255     |
| BXT2                | 337362-001                                 | 2276     |
| BXT3                | 337362-001                                 | 2274     |
| BXT4                | 337362-001                                 | 2270, 75 |
| BXT5                | 337362-001                                 | 2270, 75 |

Continued

# Presario 2200/4200

| Configuration Codes | System Board or Processor Board Spare Part | Model    |
|---------------------|--|----------|
| BXT6                | 337362-001                                 | 2270, 78 |
| BXT7                | 337362-001                                 | 2274, 75 |
| BXTB                | 337362-001                                 | 2274     |
| BXTC                | 337362-001                                 | 2274     |
| BXTD                | 337362-001                                 | 2278     |
| CDQB                | 337362-001                                 | 2262     |
| CDQC                | 337362-001                                 | 2264     |
| CDQD                | 337362-001                                 | 2260     |
| CDQ2                | 337362-001                                 | 2262     |
| CDQ3                | 337362-001                                 | 2262     |
| CDQ5                | 337362-001                                 | 2260     |
| CDQ6                | 337362-001                                 | 2268     |
| CDQ7                | 337362-001                                 | 2262     |
| CDQ8                | 337362-001                                 | 2262     |
| CDQ9                | 337362-001                                 | 2266     |
| CFH2                | 387610-001                                 | 2288     |
| CFH4                | 387610-001                                 | 2289     |
| CFH5                | 387610-001                                 | 2288     |
| CFJ2                | 387610-001                                 | 2292     |
| CFJ3                | 387610-001                                 | 2297     |
| CFJ6                | 387610-001                                 | 2294     |
| CGV2                | 387610-001                                 | 2282     |
| CGV4                | 387610-001                                 | 2280     |
| CGV5                | 387610-001                                 | 2282     |
| CGV6                | 387610-001                                 | 2284     |
| CGV7                | 387610-001                                 | 2284     |
| CGV9                | 387610-001                                 | 2280     |
| CGVB                | 387610-001                                 | 2286     |
| CGVC                | 387610-001                                 | 2285V    |
| CGW2                | 387610-001                                 | 2294     |
| CGW3                | 387610-001                                 | 2294     |
| CGW4                | 387610-001                                 | 2293     |
| CGW6                | 387610-001                                 | 2290     |

| Microprocessors            | Assembly   | Spare Part | System                    |
|----------------------------|------------|------------|---------------------------|
| 166 MHz                    |            | 235229-001 | 4200, 4220, 4222          |
| 166 MHz                    |            | 240181-001 | 4212ES                    |
| 200 MHz                    |            | 327169-001 | 2240, 2244ES              |
| 233 MHz                    |            | 170724-001 | 2246                      |
| 233X                       | 296576-003 | 319281-001 | 2253, 54                  |
| 266 MHz                    |            | 286275-001 | 4230ES                    |
| 266X                       | 296576-005 | 319236-001 | 2254, 55                  |
| 300, w/ Heat Sink          | 320471-002 | 337374-001 | 2270, 74                  |
| 300/66 (MX2)               |            | 337375-001 | 2260, 62                  |
| 300/75 (MX-2)              |            | 386217-001 | 2262, 64, 66              |
| 300X                       | 320471-004 | 319336-001 | 2255, 2256                |
| 333                        | 278308-002 | 320666-001 | 4240ES                    |
| 333/100, MHz, K6S-2        |            | 401555-001 | 2290, 92, 94              |
| 333/100, MHz, w/ Heat Sink |            | 337364-001 | 2275, 76, 78              |
| P333, M2                   |            | 388239-001 | 2281, 82, 83, 84, 85V, 86 |
| P350, M2                   |            | 388240-001 | 2288, 89                  |

Continued

Volume One

## Presario 2200/4200

| Microprocessors   | Assembly   | Spare Part | System   |
|-------------------|------------|------------|--|
| 350, K6S-2        |            | 388241-001 | 2293, 94, 97                                   |
| 400, K6S-2        | 330631-001 | 320668-001 | 2295, 97                                       |
| Heat Sink         |            | 292644-001 | 4220,4222, 4212ES                              |
| Heat Sink w/ Clip |            | 327170-001 | 2240 Series                                    |
| Heat Sink w/ Clip |            | 337369-001 | 2281, 82, 83, 84, 85V, 86, 88, 89; 2290 Series |
| Heat Sink w/ Clip |            | 317216-001 | 4230ES   |

| Memory                | Assembly                 | Spare Part | System   |
|-----------------------|--------------------------|------------|--|
| 1 MB VRAM             | 210257-004               | 327265-001 | 2240 Series, 2253, 54, 55, 56                    |
| 8 MB, 60ns, SDRAM     | 278029-002               | 288438-001 | 2240, 2244ES                                     |
| 16 MB, 60ns, SDRAM    | 271108-002               | 271117-001 | 4200   |
| 16 MB, 60ns, SDRAM    | 278030-002               | 278066-001 | 2240, 2244ES, 2246, 2255, 2256                   |
| 16 MB, 60ns, SDRAM    | 320759-101               | 319327-001 | 4240ES   |
| 16 MB, 100 MHz, SDRAM | 323010-001               | 166969-001 | 2274, 76, 78, 82, 84, 85V, 86, 89, 93, 94, 95    |
| 32 MB, 60ns, SDRAM    | 271109-002               | 271118-001 | 4200   |
| 32 MB, 60ns, SDRAM    | 286548-001               | 304287-001 | 4230ES   |
| 32 MB, 60ns, SDRAM    | 320767-101<br>320766-101 | 319326-001 | 2260, 62, 64, 70; 4240ES                         |
| 32 MB, 100 MHz, DIMM  | 323029-001               | 337372-001 | 2281, 82, 84, 85V, 86, 89, 93, 94, 95, 97        |
| 64 MB, 100 MHz, DIMM  | 323012-001               | 179190-001 | 2262, 66, 74, 75, 78, 83, 88, 89, 90, 92, 94, 97 |
| 256K Cache            | 237716-001               | 243117-001 | 2240 Series, 2253, 2254, 2255, 2256              |
| 512K Cache            | 240108-001               | 243117-002 | 4230ES   |

| Miscellaneous                     | Assembly | Spare Part | System  |
|-----------------------------------|----------|------------|---|
| Backplane Board, w/ NIC, w/o ISA  |          | 337360-001 | 2262, 74, 78, 83, 84, 89, 94  |
| Backplane Board, w/o NIC          |          | 387611-001 | 2281, 82, 85V, 86, 88, 90, 92, 93, 94, 95, 97                                   |
| Backplane Board, w/o NIC, w/ ISA  |          | 337359-001 | 2262, 74, 76  |
| Backplane Board, w/o NIC, w/o ISA |          | 386216-001 | 2260, 64, 66, 70, 74, 75  |
| Bezel                             |          | 319207-001 | 2253, 54, 55, 2256,   |
| Bezel                             |          | 337358-001 | 2280 Series, 2290 Series  |
| Bezel Button Board w/ Cable       |          | 292562-001 | Prior to 2240 Series and 4230ES   |
| Bezel Button Board w/ Cable       |          | 298468-001 | 2240 Series, 4230ES   |
| Bezel Button Board w/ Cable       |          | 319206-001 | 2250 Series; 4240ES   |
| Bezel, ES                         |          | 319279-001 | 4240ES  |
| Bezel, Front w/ Buttons           |          | 292561-001 | Prior to 2240 Series and 4230ES   |
| Bezel, Front w/ Buttons           |          | 298470-001 | 2240 Series, 4230ES   |
| Button/Headphone Board w/ Cable   |          | 337357-001 | 2260 Series, 2270 Series, 2280 Series, 2290 Series                              |
| Hard Drive Mounting Bracket       |          | 243231-001 | 2240 Series, 2253, 54, 55, 56, 4230 Series for 3.5 inch drive in 5.25 inch bay, |

Continued

# Presario 2200/4200

| Miscellaneous                      | Assembly   | Spare Part | System   |
|------------------------------------|------------|------------|--|
| Fan, System                        |            | 298474-001 | 4230ES   |
| Fan, System                        |            | 292617-001 | 4212ES, 20, 22   |
| Headphone Board                    |            | 298469-001 | 2244ES, 4230ES, 4240ES   |
| Keyboard, US English, Sunset       |            | 286241-005 | 2200; 4212ES   |
| Keyboard, US English, Education    | 286220-003 | 304286-003 | 2240, 46, 85V, 86; 2244ES; 4230ES, 4240ES                                |
| Keyboard, Ivory – US/CAN English   | 340740-003 | 340869-003 | 2254, 55, 56, 64, 66, 75, 81, 85V, 86, 92, 94                            |
| Misc Hardware Kit                  |            | 298592-001 | 2240 Series; 4240ES  |
| Misc Hardware/Plastic Kit          |            | 337368-001 | 2260 Series, 2270 Series; 2281, 82, 83, 84, 85V, 86, 88, 89; 2290 Series |
| Modem                              |            | 293020-001 | 4212ES (Teacher buy program)   |
| Modem, 33.6/56K                    | 007201-003 | 317296-001 | 2254, 55, 62, 74, 76   |
| Modem, 56K, Controllerless – Z(3C) | 337550-001 | 337559-001 | 2262, 64, 66, 74, 75, 78, 84, 85V, 86, 89, 94, 97                        |
| Modem, 56K                         |            | 292269-003 | 2253, 54, 55, 56   |
| Modem, Diamond - Spain             |            | 170762-073 | 2254   |
| Modem, Diamond - Spain             | 334790-021 | 334808-021 | 2282, 88, 92, 93, 94, 95, 97   |
| Mouse, KYE Shielded                | 149998-006 | 199181-401 | 2240 Series, 2250 Series   |
| Mouse, Ivory                       | 141649-008 | 337416-001 | 2260 Series, 2270 Series; 2281, 82, 83, 84, 85V, 86, 88, 89; 2290 Series |
| Mouse, Scroll                      | 334684-001 | 334689-001 | 2290, 94, 97   |
| Speaker, Left                      |            | 292612-001 | Prior to 2240 Series and 4230ES  |
| Speaker, Left                      |            | 298479-001 | 2240 Series, 4230ES, 4240ES  |
| Speaker, Right w/ Enclosure        |            | 292611-001 | Prior to 2240 Series and 4230ES  |
| Speaker, Right w/ Enclosure        |            | 298480-001 | 2240 Series, 4230ES, 4240ES  |

| Modem Cable Kits   | Assembly   | Spare Part | System  |
|--|------------|------------|---|
| Cable Kit, Modem, UK   | 165227-033 | 165224-032 | 2282, 90, 92  |
| Cable Kit, Modem, UK   | 165227-003 | 165224-033 | 2240, 54, 55, 56, 57, 58, 62, 74  |
| Cable Kit, Modem, US, PR, Can, Caribbean, LA, Brazil, APD, Prc, Taiwan, Japan, Spain | 112666-003 | 137256-001 | 2240, 2240ES, 2254, 55, 56, 57, 58, 62, 64, 75, 78, 82, 83, 84, 85V, 86, 88, 89, 93, 94, 95, 97 |
| Cable Kit, Modem   |            | 165224-001 | 2240  |
| Cable Kit, Modem w/ Adapter, Aus, NZ   | 112666-005 | 304398-011 | 2254, 57, 62, 82, 94, 97  |
| Cable Kit, Modem w/ Adapter, Belgium   | 112666-005 | 304398-181 | 2254, 57, 62, 92  |
| Cable Kit, Modem w/ Adapter, Denmark   | 112666-005 | 304398-081 | 2254, 57, 92  |
| Cable Kit, Modem w/ Adapter, France  | 112666-005 | 304398-051 | 2254, 55, 56, 57, 58, 60, 62, 92  |

Continued

## Presario 2200/4200

| <b>Modem Cable Kits</b>                     | <b>Assembly</b> | <b>Spare Part</b> | <b>System</b>                   |
|---|-----------------|-------------------|---------------------------------|
| Cable Kit, Modem w/<br>Adapter, Finland     | 112666-005      | 304398-351        | 2254, 57, 92                    |
| Cable Kit, Modem w/<br>Adapter, Italy       | 112666-005      | 304398-061        | 2254, 57, 62, 92                |
| Cable Kit, Modem w/<br>Adapter, Netherlands | 112666-005      | 304398-331        | 2254, 55, 57, 58, 62,<br>74, 92 |
| Cable Kit, Modem w/<br>Adapter, Sweden      | 112666-005      | 304398-101        | 2254, 57, 92                    |
| Cable Kit, Modem w/<br>Adapter, Switzerland | 112666-005      | 304398-111        | 2254, 57, 92                    |

| <b>Controller Boards</b> | <b>Assembly</b> | <b>Spare Part</b> | <b>System</b>  |
|--------------------------|-----------------|-------------------|----------------|
| NIC PCI 10/100           |                 | 169849-001        | 4230ES, 2244ES |
| PCI, 10/100, w/ TX       | 317607-001      | 317606-001        | 4240ES         |

| <b>Hard Drives</b> | <b>Assembly</b>          | <b>Spare Part</b> | <b>System</b>  |
|--------------------|--------------------------|-------------------|--|
| 1.6 GB, IDE, 3.5"  |                          | 292542-001        | 2200, 10, 12   |
| 2.1 GB, IDE        |                          | 292541-001        | 4212ES, 20, 22   |
| 2.1 GB, IDE        | 328285-001<br>166820-001 | 337366-001        | 2260, 62   |
| 2.1 GB, IDE, 3.5"  |                          | 327213-001        | 2240, 2244ES, 2246   |
| 3.2 GB, IDE        |                          | 337564-001        | 2253, 54, 55   |
| 3.2 GB, IDE        |                          | 388237-001        | 2282   |
| 4.0 GB, IDE        |                          | 286248-001        | 2253, 2254, 55, 56,<br>4230ES  |
| 4.0 GB, IDE        | 328287-001<br>320783-001 | 337379-001        | 2262, 64, 66, 70, 74,<br>75, 76, 81, 82, 83, 84,<br>85V, 88, 90, 92, 93,<br>94, 95 |
| 6.0 GB, IDE        | 241139-001               | 271127-001        | 2255   |
| 6.0 GB, IDE        |                          | 166973-001        | 2275   |
| 6.0 GB, IDE        |                          | 387612-001        | 2284, 86, 88, 89, 94,<br>97  |
| 8.0 GB, IDE        | 334180-001               | 337419-001        | 2258   |
| 8.0 GB, IDE        |                          | 298464-001        | 4240ES   |

| <b>CD-ROM Drive</b> | <b>Assembly</b> | <b>Spare Part</b> | <b>System</b>                                     |
|---------------------|-----------------|-------------------|---|
| CD-ROM, IDE, 8X     |                 | 292540-001        | 2200, 10, 12                                      |
| CD-ROM, IDE, 16X    |                 | 292569-001        | 4212ES, 20, 22                                    |
| CD-ROM, IDE, 20X    |                 | 317210-001        | 2240, 2244ES, 2246                                |
| CD-ROM, IDE, 32X    | 310185-002      | 317212-001        | 2200 Series; 2281, 83,<br>84, 85V, 86, 88, 89, 94 |
| DVD2                | 286466-408      | 317213-001        | 4230ES, 4240ES                                    |

| <b>Diskette Drives</b> | <b>Spare Part</b> | <b>System</b>  |
|------------------------|-------------------|--|
| 1.44 MB                | 292549-001        | All except 2240<br>Series and 4230ES   |
| 1.44 MB                | 239612-401        | 2240, 2244ES, 2253,<br>54, 55, 56, 58, 2260<br>Series, 2270 Series,<br>2281, 82, 83, 84,<br>85V, 86, 88, 89, 2290<br>Series; 4240ES,<br>4230ES |

# Presario 2200/4200

## 33.6 Kb/s Modem, Upgradeable to 56 Kb/s (Presario 2240, 2246, 2254, 2255)

| Country     | Cable/Adapter | Spare Part | Cable Spare Part |
|-------------|---------------|------------|------------------|
| Australia   | 304398-011    | 317296-001 | 165224-001       |
| Belgium     | 304398-181    | 317296-001 | 165224-001       |
| Denmark     | 304398-081    | 317296-001 | 165224-001       |
| Finland     | 304398-351    | 317296-001 | 165224-001       |
| France      | 304398-051    | 317296-001 | 165224-001       |
| Italy       | 304398-061    | 317296-001 | 165224-001       |
| Netherlands | 304398-331    | 317296-001 | 165224-001       |
| New Zealand | 304398-011    | 317296-001 | 165224-001       |
| Norway      | 304398-091    | 317296-001 | 165224-091       |
| Singapore   |               | 317296-001 | 165224-001       |
| Sweden      | 304398-101    | 317296-001 | 165224-001       |
| Switzerland | 304398-111    | 317296-001 | 165224-001       |
| U Kingdom   |               | 317296-001 | 165224-033       |

## 33.6 Kb/s Modem, Upgradeable to 56 Kb/s (all except Presario 2240, 2246)

| Country       | Spare Part | Cable Spare Part |
|---------------|------------|------------------|
| APD           | 293020-371 | 165224-001       |
| Australia     | 293020-012 | 165224-012       |
| Belgium       | 293020-181 | 304398-181       |
| Brazil        | 293020-001 | 165224-001       |
| Canada        | 293020-001 | 165224-001       |
| Caribbean     |            | 165224-001       |
| Denmark       | 293020-001 | 304398-081       |
| France        | 293020-051 | 304398-051       |
| Germany       | 293020-041 | 286241-045       |
| Italy         | 293020-161 | 165224-062       |
| Japan         | 293020-291 | 165224-001       |
| Korea         |            | 165224-001       |
| Latin America | 293020-001 |                  |
| Mexico        | 293020-001 | 165224-001       |
| Netherlands   | 293020-331 | 304398-331       |
| New Zealand   | 293020-012 | 165224-033       |
| Norway        | 317296-001 | 304398-091       |
| Portugal      |            | 165224-131       |
| PRC/Thailand  | 293020-001 | 165224-001       |
| Puerto Rico   |            | 165224-001       |
| Singapore     | 293020-AF1 | 165224-001       |
| Spain         |            | 165224-071       |
| Sweden        | 293020-101 | 304398-101       |
| Switzerland   | 293020-111 | 304398-111       |
| Taiwan        | 293020-AB1 | 165224-001       |
| U Kingdom     | 293020-031 | 165224-033       |
| US            | 293020-001 | 165224-001       |
| US 4212ES     | 293020-001 | 165224-001       |

# Presario 2200/4200

## Daughter Cards to Upgrade to 56 Kb/s

| Country                         | Spare Part |
|---------------------------------|------------|
| One part supports all countries | 292614-001 |

## 56 Kb/s DSVD (Presario 2240, 2246, 2253, 2254, 2255, 2256, 2257)

| Country  | Modem<br>PCA | Spare Part | Cable<br>Spare Part |
|--|--------------|------------|---------------------|
| APD English (Malaysia, Hong Kong, Vietnam, Indonesia, Philippines) | 292256-003   | 292269-003 | 137256-001          |
| Brazil   | 292256-003   | 292269-003 | 137256-001          |
| Caribbean  | 292256-003   | 292269-003 | 137256-001          |
| Japan  | 292256-003   | 292269-003 | 137256-001          |
| Latin America  | 292256-003   | 292269-003 | 137256-001          |
| Mexico   | 292256-003   | 292269-003 | 137256-001          |
| PRC/Thailand   | 292256-003   | 292269-003 | 137256-001          |
| Puerto Rico  | 292256-003   | 292269-003 | 137256-001          |
| Spain  | 170740-001   | 170762-073 | 137256-001          |
| Taiwan   | 292256-003   | 292269-003 | 137256-001          |
| US /Canada   | 292256-003   | 292269-003 | 137256-001          |

| Cables                   | Assembly   | Spare Part | System   |
|--------------------------|--|------------|--|
| Cable Kit                |  | 292568-001 | All except 2240 and 4230ES Series  |
| Cable Kit, Miscellaneous |  | 170720-001 | 2240 Series, 2253, 54, 55, 56, 4230ES                                    |
| Cable Kit, Miscellaneous |  | 337361-001 | 2260 Series, 2270 Series, 2281, 82, 83, 84, 85V, 86, 88, 89, 2290 Series |
| Cable Kit, Miscellaneous | 298486-001<br>310188-003<br>349006-001<br>320558-001 | 337562-001 | 4240ES   |

| Battery/Power Supply           | Spare Part | System   |
|--------------------------------|------------|--|
| Battery, Replaceable           | 234556-001 | All  |
| Power Supply, 51W, Auto-Detect | 293814-001 | All except 2240 and 4230ES Series                  |
| Power Supply, 75W              | 337373-001 | 2260 Series, 2270 Series, 2280 Series, 2290 Series |
| Power Supply, 75W, w/ Baffle   | 319234-001 | 2250 Series  |
| Power Supply, 75W, w/ Baffle   | 298471-001 | 2240, 2244ES                                       |
| Power Supply, 110W             | 317218-001 | 4230ES   |
| Power Supply, 110W, w/ Baffle  | 319235-001 | 4240ES   |



# Presario 2200/4200

Presario 2200 Series

## Memory Upgrade Chart

I/O BOARD

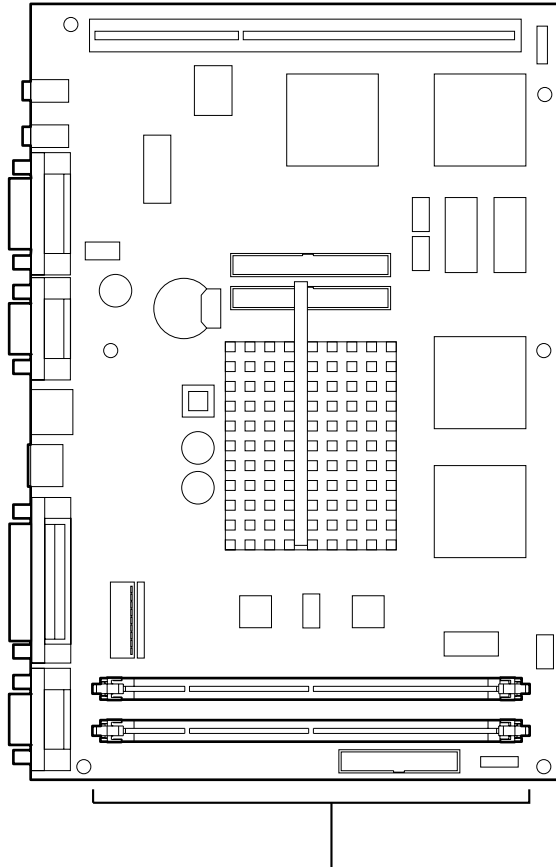

A MAXIMUM OF 80 MB TOTAL MEMORY

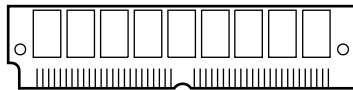

NO OPTIONS

NO SPARES, ALL MEMORY DOWN

# Presario 2200/4200

Presario 2240 Series

## Memory Upgrade Chart

I/O BOARD 16 MB  
327149-001

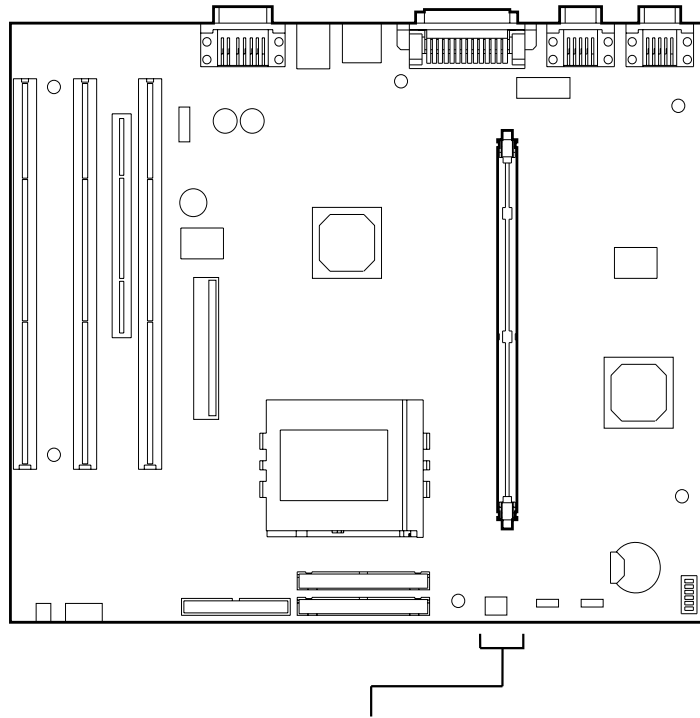

A MAXIMUM OF 48MB TOTAL MEMORY  
16 MB STANDARD .

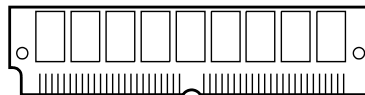

32-MB SDRAM DIMMS, - OPTION PN 271434-001

# Presario 2200/4200

Presario 2253, 2254, 2255, 2256

## Memory Upgrade Chart

PROCESSOR BOARD  
310198-001  
(32 MB)

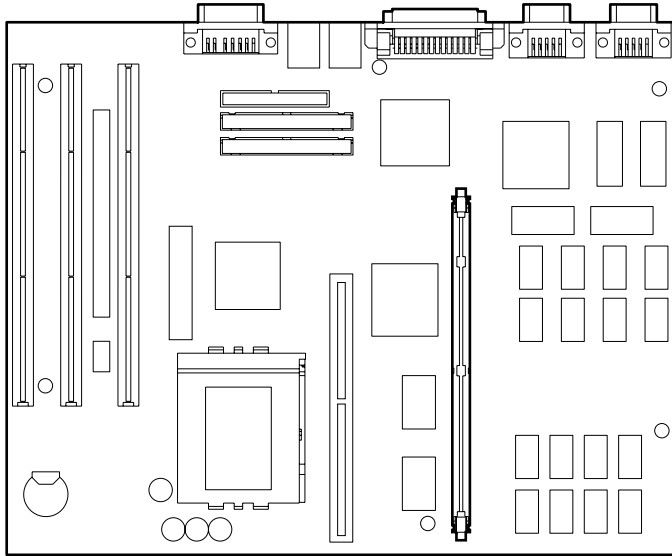

A MAXIMUM OF 48 OR 64 MB TOTAL MEMORY  
32 MB STANDARD MEMORY SOLDERED  
ON SYSTEM BOARD.

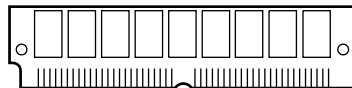

MEMORY OPTIONS ARE NOT AVAILABLE FOR THE  
PRESARIO 2250 SERIES, 2510, AND 2410ES

# Presario 2200/4200

Presario 2260, 2262,  
2264, 2266, 2270, 2274, 2275, 2276, 2278

## Memory Upgrade Chart

PROCESSOR BOARD

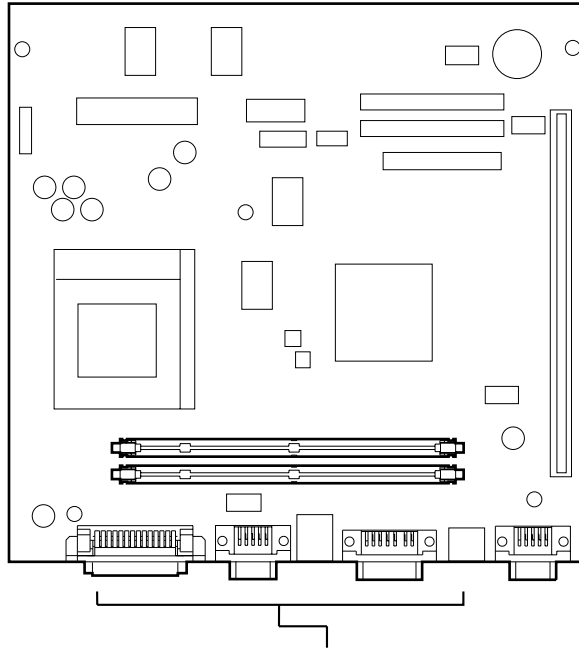

A MAXIMUM OF 256 MB TOTAL MEMORY  
USE 16, 32, OR 64 MB 100 MHz DIMMs

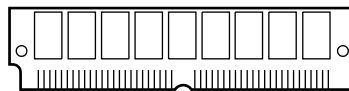

MEMORY OPTIONS ARE NOT AVAILABLE

# Presario 2200/4200

## Presario 2285V Series

### Memory Upgrade Chart

SYSTEM BOARD  
(96MB)

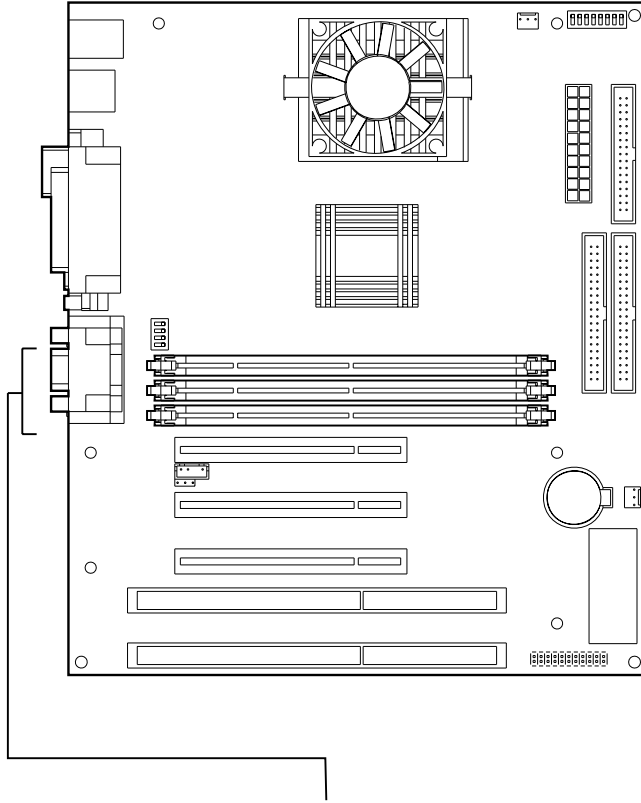

MAXIMUM MEMORY 384MB

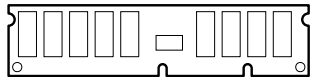

32-MB 100MHz SDRAM DIMM - OPTION PN 308875-001

64-MB 100MHz SDRAM DIMM - OPTION PN 308877-001

128-MB 100MHz SDRAM DIMM - OPTION PN 308878-001

# Presario 2200/4200

## Presario 4200 Series

### Memory Upgrade Chart

I/O BOARD

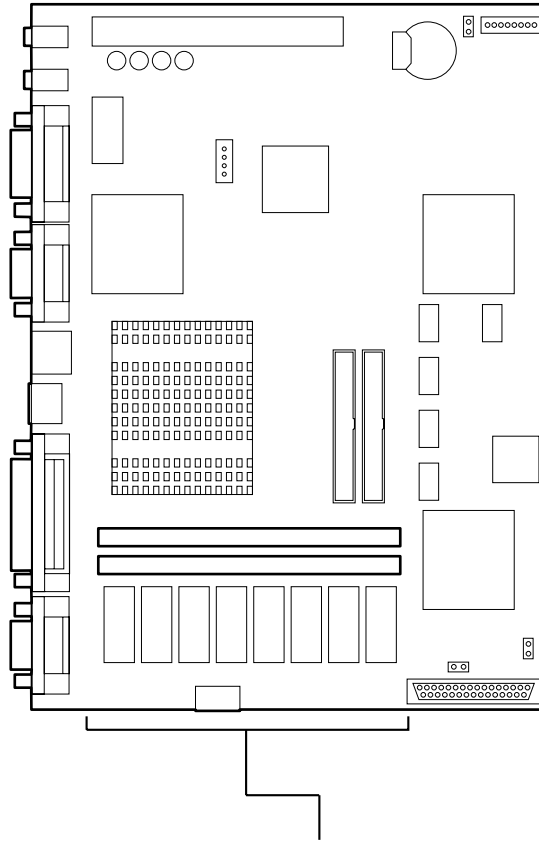

A MAXIMUM OF 80 MB TOTAL MEMORY

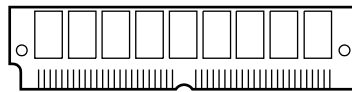

NO MEMORY OPTIONS

16-MB SDRAM DIMM - SPARE PN 271117-001

32-MB SDRAM DIMM - SPARE PN 271118-001

# Presario 2200/4200

## Presario 4230 Series

### Memory Upgrade Chart

I/O BOARD 32 MB EDO  
311009-001

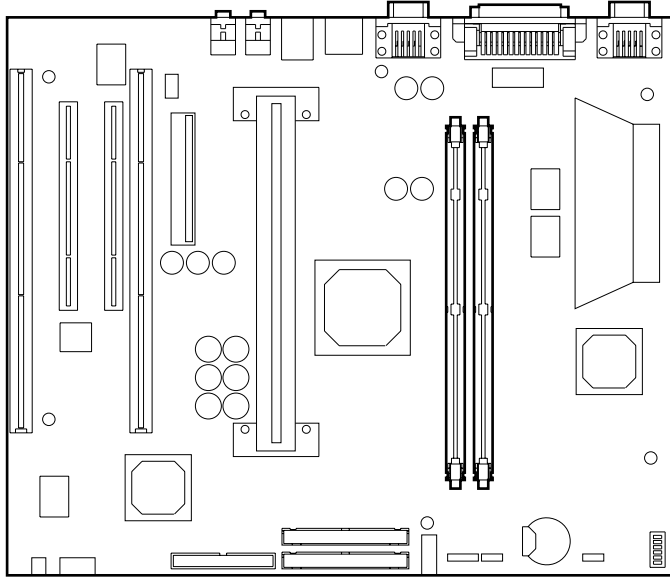

A MAXIMUM OF 256 MB TOTAL MEMORY

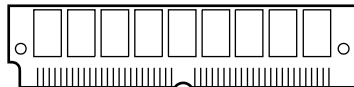

16-MB DIMMS, - OPTION PN 271433-001

32-MB DIMMS, - OPTION PN 271434-001

64-MB DIMMS, - OPTION PN 309081-001

128-MB DIMMS, - OPTION PN 309082-001

# Presario 2200/4200

Presario 4240ES Series

## Memory Upgrade Chart

PROCESSOR BOARD  
SPARE PART # 319277-001

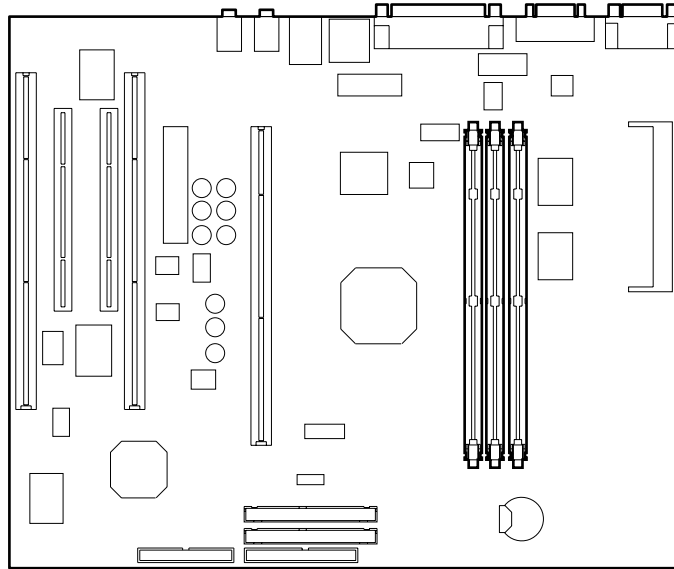

A MAXIMUM OF 384 MB TOTAL MEMORY

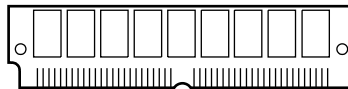

16-MB SDRAM DIMMs - OPTION PN 271433-001

32-MB SDRAM DIMMs - OPTION PN 271434-001

64-MB SDRAM DIMMs - OPTION PN 309081-001

128-MB SDRAM DIMMs - OPTION PN 309082-001