

# USER'S MANUAL

PR5 R2 PCI MAIN BOARD

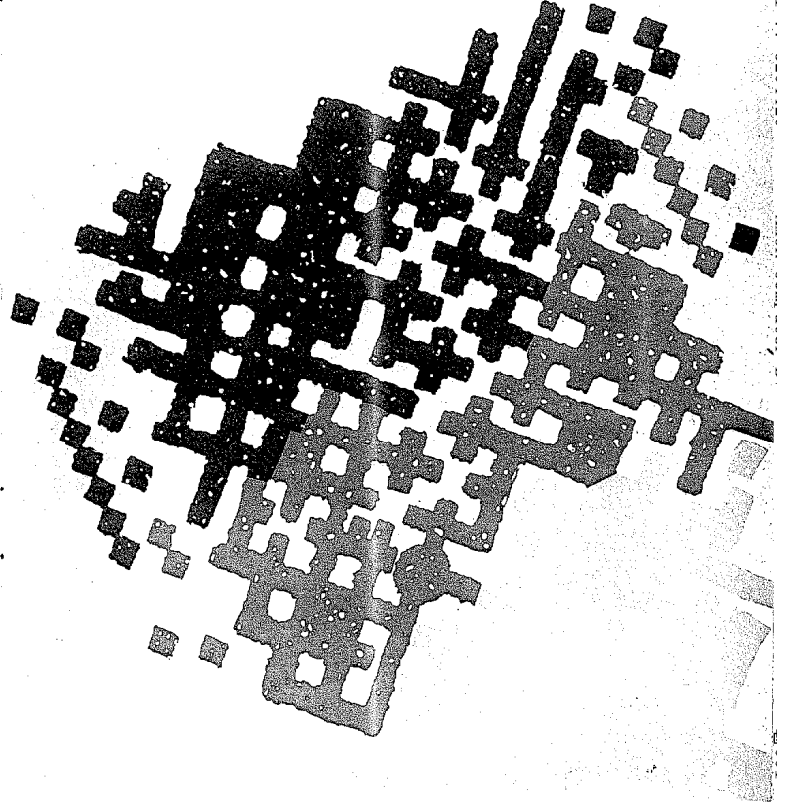

Part Number: MN-084-B12-01



# Pentium Mainboard

## USER'S MANUAL

### Table of Contents

---

<b>Chapter 1</b>	<b>System Board Overview</b>	
	Specifications .....	1-1
	Component Placement .....	1-3
	The system block diagram .....	1-4
<hr/>		
<b>Chapter 2</b>	<b>Hardware Setup</b>	
	Precautions .....	2-1
	Connectors .....	2-1
	Jumper Switches .....	2-6
	Installation of Intel CPU .....	2-8
	Installation of AMD CPU .....	2-11
	Installation of CyrixCPU .....	2-14
	Installation of Memory .....	2-16
<hr/>		
<b>Chapter 3</b>	<b>Award BIOS Setup</b>	
	Standard CMOS Setup Menu .....	3-3
	BIOS Features Setup Menu .....	3-5
	Chipset Features Setup Menu .....	3-7
	Power Management Setup .....	3-8
	PCI & Onboard I/O Setup .....	3-11
	Load BIOS Defaults .....	3-13
	Load Setup Defaults .....	3-13
	Setting Password .....	3-14

IDE HDD Auto Detection.....3-14  
HDD Low Level Format .....3-14  
Standard types of hard disks .....3-15

---

**Chapter 4 Bus Master IDE Driver**

---

# Chapter 1

---

## System Board Overview

The mainboard provides a high degree of system flexibility. It supports the Pentium family of CPUs, 256KB pipelined burst cache, memory up to 128MB, super I/O, and Green PC functions. The mainboard offers the platform for integrating a system in a high performance configurations.

### Specifications

---

- |                       |  |
|-----------------------|--|
| 1. CPU:               | Intel Pentium 75 ~ 200 MHz,<br>AMD 5k86-Pxxx,<br>Cyrix 6x86  |
| 2. Chipset:           | Intel 82430 VX chipset   |
| 3. Cache memories:    | 256K Pipeline Burst SRAM   |
| 4. Memory:            | Using four 72pin SIMM modules<br>Support from 8MB to 128MB   |
| 5. On board IDE:      | Two E-IDE channels,<br>Supports up to 4 Hard Drives  |
| 6. On board FDC:      | Supports two floppy disk drives  |
| 7. On board Fast I/O: | One EPP/ECP parallel port (IEEE<br>1284 Compliant) and two high speed<br>16550A Compliant UARTs.<br>Supports Infrared -- IrDA(HPSIR) and<br>Amplitude Shift Keyed IR(ASKIR).   |
| 8. I/O slots:         | Three 32-bit PCI slots, four 16-bit ISA<br>slots   |
| 9. BIOS:              | Award Plug and Play BIOS   |
| 10. Special Features: | <ul style="list-style-type: none"><li>• Supports EDO DRAM</li><li>• Three PCI Masters</li><li>• Supports "PCI Bus master IDE controller" to reduce the work load of the CPU</li><li>• Supports the Universal Serial Bus(USB)</li></ul> |

- PCI 2.1 compliant
- Support for Symmetrical and Asymmetrical DRAMs

### Component Placement

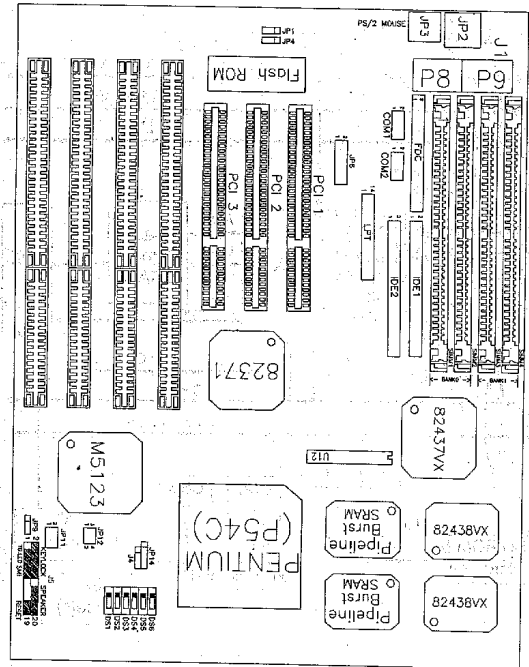
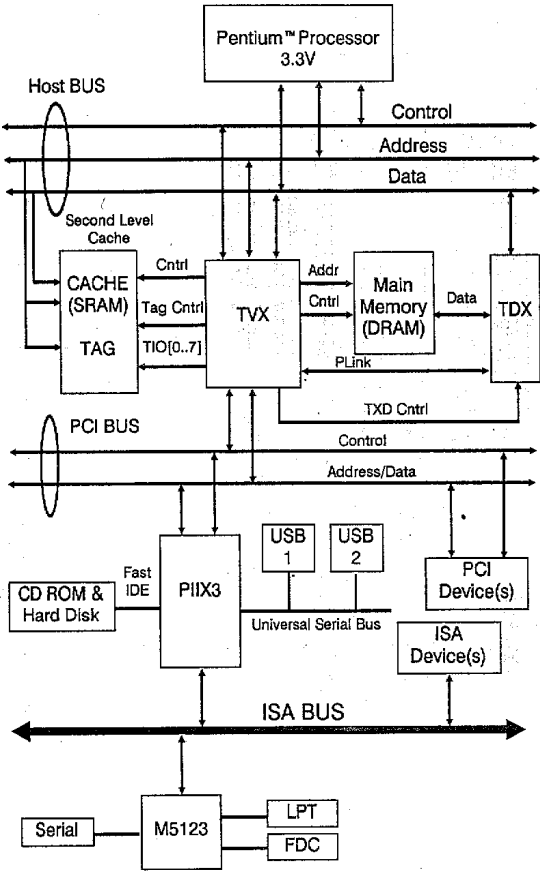

Figure 1-1. Component Locations

### The system block diagram



# Chapter 2

## Hardware Setup

This chapter describes the mainboard's connectors and how to set the mainboard's jumpers.

### Precautions

You should take the following precautions before you begin working with the motherboard and its components:

- Turn off the mainboard's power, and unplug the power cord.
- Unplug all cables connect the mainboard to any external devices.

*Caution:* Make sure you first turn off all power to the system before attaching components to the mainboard.

### Connectors

You attach system components and case devices to the mainboard's connectors. A description of each connector and its pin assignments follows. Refer to Figure 1-1 for connector locations on the mainboard.

#### J5(Pin 14-16-18-20) - Speaker Connector

Attach the system speaker to connector J5.

Pin	Assignment
14	Sound signal.
16	Ground
18	Ground
20	+5VDC.



**J5(Pin 17-19) - Hardware Reset Connector**

Attach the cable from the case's Reset switch to this connector. Press and hold the reset button for at least one second to reset the system.

Pin	Assignment
17	Reset input
19	Ground

**J5(Pin 7-9) - Hardware Suspend Switch (SMI Switch)**

Attach the cable from the case's suspend switch (if exist) to this switch. Use this switch to enable/disable the power management function by hardware.

Pin	Assignment
7	Suspend signal
9	Ground

**J5(Pin 2-4-6-8-10) - Keylock and Power LED Connector**

Attach the case's keylock to this connector.

Pin	Assignment
2	+5VDC
4	No connection
6	Ground
8	Keyboard inhibit Signal
10	Ground

**J5(Pin 3-5) - Turbo LED Connector**

With proper connection, the turbo LED lights when the system is in turbo speed mode.

Pin	Assignment
3	Turbo signal
5	Ground

---

## Chapter 4

---

**Bus Master IDE Driver**

The Intel PIIX3 Bus Master IDE is now include in the mainboard.

**OS Support:** Windows 95, Windows NT 3.5/3.51, OS/2 V2.x & Warp 3.0

**Installation:** Each OS has different install procedure, please check README.TXT file under each OS's directory.

**JP3 - PS/2 Mouse Connector**

Attach a PS/2 mouse or cable to this connector.

Pin	Assignment
1	Mouse data
2	No connection
3	Ground
4	+5VDC
5	Mouse clock
6	No connection

**JP2 - Keyboard connector**

Attach a keyboard to this 5-pin connector.

Pin	Assignment
1	Keyboard clock
2	Keyboard data
3	No connection
4	Ground
5	+5VDC

**J1 - Power input connector**

Attach the connectors from the power supply to J1.

**Caution:** *If power supply connectors are not properly attached to J1, the power supply or add-on cards may be damaged.*

Pin	Description	Pin	Description
1	Powergood	7	Ground
2	+5V	8	Ground
3	+12V	9	-5V
4	-12V	10	+5V
5	Ground	11	+5V
6	Ground	12	+5V

**JP9 - FAN Power Connector**

Pin	Assignment
1	Ground
2	+12V
3	Ground

**JP6 - USB Connector**

Reserved. (Universal Serial Bus)

Pin	Assignment	Pin	Assignment
1	+5V	2	Ground
3	USBP0-	4	Ground
5	USBP0+	6	Ground
7	Ground	8	Ground
9	+5V	10	Ground
11	USBP1-	12	Ground
13	USBP1+	14	Ground
15	Ground	16	Ground

**JP14 - IR connector (Infrared)**

Pin	Assignment
1	+5V
2	No connection
3	IR_TX
4	Ground
5	IR_RX

**J4 - HDD LED Connector**

Attach the cable from the case's HDD-LED to this connector.

Pin	Assignment
1	Cathode terminal of LED
2	Anode terminal of LED
3	Anode terminal of LED
4	Cathode terminal of LED

**Standard types of hard disks**

Type	Size	Cylinders	Heads	W-Pcomp	L-Zone	Sect
1	10MB	306	4	128	305	17
2	20MB	615	4	300	615	17
3	30MB	615	6	300	615	17
4	62MB	940	8	512	940	17
5	49MB	940	6	512	940	17
6	21MB	615	4	65535	615	17
7	32MB	462	8	256	511	17
8	31MB	733	5	65535	733	17
9	117MB	900	15	65535	901	17
10	20MB	820	3	65535	820	17
11	35MB	855	5	65535	855	17
12	49MB	855	7	65535	855	17
13	20MB	306	8	128	319	17
14	42MB	733	7	65535	733	17
16	20MB	612	4	0000	663	17
17	40MB	977	5	300	977	17
18	56MB	977	7	65535	977	17
19	59MB	1024	7	512	1023	17
20	30MB	733	5	300	732	17
21	42MB	733	7	300	732	17
22	30MB	733	5	300	733	17
23	10MB	306	4	0000	336	17
24	53MB	925	7	0000	925	17
25	69MB	925	9	65535	925	17
26	43MB	754	7	754	754	17
27	68MB	754	11	65535	754	17
28	40MB	699	7	256	699	17
29	68MB	823	10	65535	823	17
30	53MB	918	7	918	918	17
31	93MB	1024	11	65535	1024	17
32	127MB	1024	15	65535	1024	17
33	42MB	1024	5	1024	1024	17
34	10MB	612	2	128	612	17
35	76MB	1024	9	65535	1024	17
36	68MB	1024	8	512	1024	17
37	40MB	615	8	128	615	17
38	24MB	987	3	987	987	17
39	57MB	987	7	987	987	17
40	40MB	820	6	820	820	17
41	40MB	977	5	977	977	17
42	40MB	981	5	981	981	17
43	48MB	830	7	512	830	17
44	68MB	830	10	65535	830	17
45	114MB	917	15	65535	918	17
46	152MB	1224	15	65535	1223	17

## Setting Password

This Main Menu item lets you configure the system so that a password is required every time the system boots or an attempt is made to enter the Setup program. Change the password as follows:

1. Choose "PASSWORD SETTING" in the Main Menu and press <Enter>. The following message appears:

"Enter Password:"

2. Enter a password and press <Enter>.

(If you do not wish to use the password function, you can just press <Enter> and a "Password disabled" message appears.)

3. After you enter your password, the following message appears prompting you to confirm the new password:

"Confirm Password:"

4. Re-enter your password and then Press <ESC> to exit to the Main Menu.

**Important:** If you forget or lose the password, the only way to access the system is to set the CMOS RAM discharge jumper to clear the CMOS RAM. All setup information is lost and you must run the BIOS setup program again.

## IDE HDD Auto Detection

The BIOS automatically detects the hard disk type and configures the STANDARD CMOS SETUP accordingly.

## HDD Low Level Format

The BIOS can preformat IDE Hard Disk and all data on the HDD will be destroyed. Before your preformat IDE Hard Disk, must change HDD Mode to "Normal"!

## I/O port Connectors

Name	No. of pins	Description
IDE1	40	IDE channel 1 connector
IDE2	40	IDE channel 2 connector
FDC	34	Floppy Disk connector
LPT	26	Parallel port connector
COM1	10	Serial port COM1 connector
COM2	10	Serial port COM2 connector

Notes: \*IDE1, IDE2 are high performance PCI IDE connectors. Up to four IDE interface devices are supported.

## Jumper Switches

You set jumper switches on the mainboard to configure various hardware options. See Figure 1-1 for jumper locations.

Throughout this section the following symbols are used to indicate jumper settings.

For 3-pin jumpers, the symbols below are used:

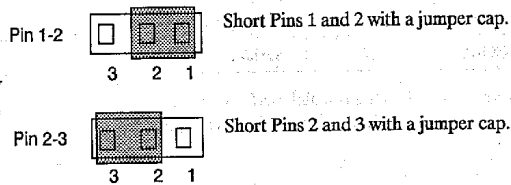

For 2-pin jumpers, the following symbols are used:

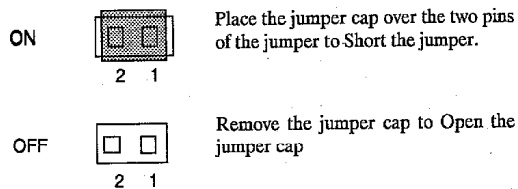

Note: To avoid losing jumper caps, attach the removed jumper cap to one of the jumper pins.

<b>IR Tr/Re Polarity</b>	Setting IR transmit and receive polarity active high or low.
<b>IR Duplex Mode</b>	IR duplex mode Half(Default) or Full selection.
<b>Onboard Parallel Port</b>	Choose Disable, 3BCh/IRQ7, 278h/IRQ5, or 378h/IRQ7 (Default) to set the on-board parallel port.
<b>Parallel Port Mode</b>	Choose EPP1.7, EPP1.9, ECP, ECP + EPP1.7, ECP + EPP1.9, PS/2, or Normal (Default) mode.
<b>ECP Mode Use DMA</b>	Choose DMA channel 1 or channel 3 to set the ECP mode.
<b>Onboard IDE Controller</b>	This option enables or disables the one board PCI IDE controller.
<b>Onboard IDE PIO Mode</b>	Choose Mode 0~ Mode 4, or Auto (Default) to change IDE data transfers speed.

## Load BIOS Defaults

BIOS Defaults indicates the values required by the system for the *minimum* performance. Choose this item and the following message appears:

“Load BIOS Defaults (Y/N)? N”

To use the BIOS defaults, change the prompt to “Y” and press <Enter>.

## Load Setup Defaults

Setup Defaults indicates the values of system parameters which will give the best performance. Choose this item and the following message appears:

“Load SETUP Defaults (Y/N)? N”

To use the SETUP defaults, change the prompt to “Y” and press <Enter>.

### PCI IDE Card IRQ Map to

#### PCI-Auto:

If the BIOS can detect PCI IDE on one of the PCI slots, then the appropriate INT# will be auto-assigned to IRQ14.

#### PCI-slotX:

If the BIOS can not detect a PCI IDE card, (because the PCI IDE card does not support this function) the user needs to manually select the PCI-slot occupied by the PCI IDE card.

#### Primary IDE INT#, Secondary IDE INT#:

If the IDE card supports 2 IDE channels, the BIOS needs to assign 2 INT channels for the IDE card. (Don't select same INT#)

#### ISA:

This setting assigns no IRQs to the PCI slots. Use this setting with PCI IDE cards that connect IRQ14 and IRQ15 directly from an ISA slot using a cable from a legacy paddleboard.

Note: M/B PCI Slot INT# hardware is designed as below:

"Slot1-INT#A", "Slot2-INT#B", and "Slot3-INT#C" are assigned to the same IRQ. (Do not use them at the same time.)

"Slot1-INT#B", "Slot2-INT#C", and "Slot3-INT#D" are assigned to the same IRQ. (Do not use them at the same time.)

"Slot1-INT#C", "Slot2-INT#D", and "Slot3-INT#A" are assigned to the same IRQ. (Do not use them at the same time.)

"Slot1-INT#D", "Slot2-INT#A", and "Slot3-INT#B" are assigned to the same IRQ. (Do not use them at the same time.)

**PS2 Mouse Function (IRQ12)** This option enables/disables the PS2 mouse function control. (The Default setting is Enabled.)

**Onboard FDD Controller** This option enables or disables the on-board floppy disk controller.

**Onboard Serial Port X** Choose Disable, 3F8h/IRQ4, 2F8h/IRQ3, 3E8h/IRQ4, 2E8h/IRQ3 to set the on-board serial ports. But don't choose duplicate I/O port and IRQ.

**Serial Port 2 Use IR** This option enables/disables the IR function in on-board serial port 2 and selects IR mode HPSIR(IrDA) or ASKIR(Amplitude Shift Keyed IR).

### JP1 - CMOS Discharge Jumper

Jumper JP1 discharges CMOS memory. When you install the motherboard, make sure this jumper is set for Normal Operation(1-2). See the jumper as below.

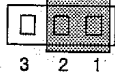
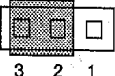
Setting	JP1
Normal Operation (Default)	
Discharge CMOS	

### JP4 - Flash ROM Voltage

Use JP4 to select the Flash ROM voltage.

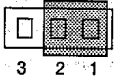
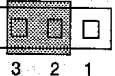
Setting	JP4
5V Flash ROM	
12V Flash ROM (Default)	

Note: The manufacturer may remove the JP4 and place a fixed wire soldered "ON" Pin2 and Pin3 when used a 12V Flash-ROM.

### Installation of Intel CPU

The mainboard is equipped with a socket 5/socket 7 ZIF socket to accommodate various CPUs. Since there are many types of CPUs available, check your CPU type carefully before installation. Follow the steps below to set the mainboard jumpers for your CPU:

#### CPU external clock selection

Use DS3, DS4 to select CPU external clock.

External clock	DS3	DS4	Comments
50 MHz	ON	ON	50 x 1.5 = 75 for P75
60 MHz	OFF	ON	60 x 1.5 = 90 for P90 60 x 2 = 120 for P120 60 x 2.5 = 150 for P150
66 MHz (Default)	ON	OFF	66 x 1.5 = 100 for P100 66 x 2 = 132 for P133 66 x 2.5 = 165 for P166 66 x 3 = 198 for P200

#### Clock Multiplier factor

DS1, DS2 are used to select the multiplier factor of installed CPU.

CPU internal clock = multiplier factor x external clock.

Clock multiplier factor	DS2	DS1	Comments
1.5	OFF	OFF	50 x 1.5 = 75 for P75 60 x 1.5 = 90 for P90 66 x 1.5 = 100 for P100
2 (Default)	ON	OFF	60 x 2 = 120 for P120 66 x 2 = 132 for P133
2.5	ON	ON	60 x 2.5 = 150 for P150 66 x 2.5 = 166 for P166
3	OFF	ON	60 x 3 = 180 for P180 66 x 3 = 198 for P200

### PCI & Onboard I/O Setup

The PCI & Onboard I/O Setup option lets you assign INT#, IRQs, I/O ports, and other hardware settings to the mainboard's PCI slots and onboard I/O.

ROM PCI/ISA BIOS (00000000)  
PCI & ONBOARD I/O SETUP  
AWARD SOFTWARE, INC.

PCI PnP BIOS Auto-Config	: Disabled	Onboard FDD Controller	: Enabled
PCI IRQ Activated By	: Level	Onboard Serial Port 1	: 3F8/IRQ4
1st Available IRQ	: 8	Onboard Serial Port 2	: 2F8/IRQ3
2nd Available IRQ	: 11	- Serial Port 2 Use IR	: HP&IR
3rd Available IRQ	: 10	- IR Duplex Mode	: Half
4th Available IRQ	: 5	- IR Tx/Rx Polarity	: Hi/Hi
PCI IDE Card 2nd Channel	: Enable	Onboard Parallel Port	: 378/IRQ7
PCI IDE Card IRQ Map To	: PCI-AUTO	- Parallel Port Mode	: ECP + EPP1.9
Primary IDE INT#	: A	- ECP Mode Use DMA	: 3
Secondary IDE INT#	: B		
PS/2 Mouse Function (IRQ12)	: Enabled		
Onboard IDE-1 Controller	: Enabled		
- Master Drive PIO Mode	: Auto		
- Slave Drive PIO Mode	: Auto		
Onboard IDE-2 Controller	: Enabled		
- Master Drive PIO Mode	: Auto		
- Slave Drive PIO Mode	: Auto		

Esc : Quit      ↓ ↑ → ← : Select item  
F1 : Help      F2/F3/F4/F5 : Modify  
F5 : Old Values (Shift/F2 : Color)  
F8 : Load BIOS Defaults  
F7 : Load Setup Defaults

Figure 3-6 PCI Configuration Setup Menu

**PCI PnP BIOS Auto-Config** Choose Enabled or Disabled (Default). If Enabled the BIOS will automatically assigns IRQ to the PCI INT#. If Disabled the PCI INT# will be assigned by the next setup item - "Xth Available IRQ".

**Xth Available IRQ** These categories select a IRQ for INT#. There are ten IRQs options (3, 4, 5, 7, 9, 10, 11, 12, 14, 15) for available IRQs. 1st Available IRQ means BIOS will assign this IRQ to first INT found on the PCI slots (the assignment sequence is slot1, 2, 3).

**PCI IDE Card 2nd Channel** Choose Disable or Enable (Default). If the 2nd channel is not used on the PCI IDE card, switch the option to "Disable". Or IRQ15 can not work on the ISA slots.

**Suspend Mode** The default setting is Disabled. When the Power Management item is switched to "User Define" you can select a time interval from 1 minute to 1 hour. When the set time elapses without activity the system enters Suspend mode.

If the idle time for all PM events is greater than the Suspend time you set the system will enter Suspend mode, and the CPU Internal frequency drops to 0 MHz. If the "Video Off Option" is set to "Suspend—Off", the screen will shut off.

**Wake-up Event** "ON" - Wake up the system when IRQn signal received in the Doze & Standby mode.

"OFF" - IRQn signal does not wake up the system, when the system is in the Doze & Standby mode.

**Power Down & Resume Events** There are several Power Management events can be selected — IRQ3-15 Activity.

"ON" - Reset green timer whenever PM Events Activity.

"OFF" - Discard any PM Events Activity and continuously accumulate timer count down for green function.

- After you have finished with the Power Management Setup, press the <ESC> key to return to the Main Menu.

### AT Bus Clock Selection

Use jumper (DSS) to select the divider factor from CPU external clock for AT Bus clock.

Divider factor	DSS
CPU external clock Divide by 8	ON (Default)
CPU external clock Divide by 6	OFF

Note: The default setting is suitable for good compatibility with ISA Add On card. You may set this jumper(DSS) to "OFF" to reach better I/O performance when your ISA Add On card can work with a little higher frequency.

### CPU Voltage

Voltage	CPU Type	JP11	JP12										
3.52V (VRE)	Intel Pentium	<table border="1"> <tr><td>2</td><td>4</td><td>6</td></tr> <tr><td>1</td><td>3</td><td>5</td></tr> </table>	2	4	6	1	3	5	<table border="1"> <tr><td>3</td><td>4</td></tr> <tr><td>1</td><td>2</td></tr> </table>	3	4	1	2
2	4	6											
1	3	5											
3	4												
1	2												
3.38V (STD/VR) (Default)	Intel Pentium	<table border="1"> <tr><td>2</td><td>4</td><td>6</td></tr> <tr><td>1</td><td>3</td><td>5</td></tr> </table>	2	4	6	1	3	5	<table border="1"> <tr><td>3</td><td>4</td></tr> <tr><td>1</td><td>2</td></tr> </table>	3	4	1	2
2	4	6											
1	3	5											
3	4												
1	2												



**Power On DRAM Refresh rate**

Use DS6 to select power on DRAM refresh rate. (Default: OFF)

**CPU Clock Selection Summary**

Intel Pentium CPU		DRAM refresh		ISA speed		Ext. clock selection		Multiplier factor selection	
CPU Type	Ext. clock	DS6	DS5	DS4	DS3	DS2	DS1		
P75	50 MHz	OFF	OFF	ON	ON	OFF	OFF		
P90	60 MHz	OFF	ON	ON	OFF	OFF	OFF		
P100	66 MHz	OFF	ON	OFF	ON	OFF	OFF		
P120	60 MHz	OFF	ON	ON	OFF	ON	OFF		
P133	66 MHz	OFF	ON	OFF	ON	ON	OFF		
P150	60 MHz	OFF	ON	ON	OFF	ON	ON		
P166	66 MHz	OFF	ON	OFF	ON	ON	ON		
P200	66 MHz	OFF	ON	OFF	ON	OFF	ON		

**Video Off Method** Choose DPMS, Blank screen, or V/H Sync + Blank (Default). With this item V/H SYNC is controlled by software. If you have a VGA card that is not compatible with the default option, switch to "Blank screen", even though it consumes more power than "V/H SYNC + Blank". If your VGA card and VGA monitor support VESA DPMS, switch the option to "DPMS".

**Video Off Option** Choose "Always On" (Default), "All Modes — Off" (Suspend, Standby and Doze mode), "Susp, Stby — Off". This item shuts the video off when entering Doze mode, Standby mode or Suspend mode.

**HDD Power Down** Choose a time interval from 1 to 15 minutes or "Disabled" (Default). When the set time has elapsed, the BIOS sends a command to the HDD to enter idel (sleep) mode, turning off the motor. This function is only valid for IDE HDDs that support power saving function.

**Doze Mode** The default setting is Disabled. When the Power Management item is switched to "User Define" you can select a time interval from 1 minute to 1 hour. When the set time elapses without activity the system enters Doze mode.

If the idle time for all PM events — IRQ 3-15 Activity — is greater than the Doze time you set the system will enter Doze mode, and the CPU speed slows down. If the Video Off Option is set to "All Modes — Off", the screen shuts off.

**Standby Mode** The default setting is Disabled. When the Power Management item is switched to "User Define" you can select a time interval from 1 minute to 1 hour. When the set time elapses without activity the system enters Standby mode.

If the idle time for all PM events is greater than the Standby time you set the system will enter Standby mode, and the CPU speed slows down. If the "Video Off Option" is set to "Sus, Stby—Off", the screen will shut off.

## Power Management Setup

The Power Management Setup option lets you set the system's power saving functions.

1. Choose "POWER MANAGEMENT SETUP" from the Main Menu.

ROM PCI/ISA BIOS (XXXXXXXX)  
POWER MANAGEMENT SETUP  
AWARD SOFTWARE, INC.

Power Management : Disable	** Power Down & Resume Events **
PM Control by APM : No	IRQ 3 (COM 2) : ON
Video Off Method : V/H SYNC+Blank	IRQ 4 (COM 1) : ON
Video Off Option : Always On	IRQ 5 (LPT2) : ON
	IRQ 6 (Floppy Disk) : ON
Doze Mode : Disable	IRQ 7 (LPT 1) : ON
Standby Mode : Disable	IRQ 8 (RTC Alarm) : OFF
Suspend Mode : Disable	IRQ 9 (IRQ2 Redir) : OFF
HDD Power Down : Disable	IRQ 10 (Reserved) : OFF
	IRQ 11 (Reserved) : OFF
** Wake Up Events In Doze & Standby **	IRQ 12 (PS/2 Mouse) : ON
IRQ 3 (Wake-Up Event) : ON	IRQ 13 (Coprocessor) : ON
IRQ 4 (Wake-Up Event) : ON	IRQ 14 (IDE-1) : ON
IRQ 8 (Wake-Up Event) : OFF	IRQ 15 (IDE-2) : ON
IRQ 12 (Wake-Up Event) : ON	

Esc : Quit      ↑ ↓ → ← : Select Item  
F1 : Help      PU/PD/+/- : Modify  
F5 : Old Values (Shift)F2 : Color  
F8 : Load BIOS Defaults  
F7 : Load Setup Defaults

Figure 3-5 Power Management Setup Menu

2. Use the arrow keys to move between items and to select values. Modify the selected fields using the PgUp/PgDn/ +/- keys.

A short description of selected screen items follows:

<b>Power Management</b>	Options are as follows:
<b>User Define</b>	Set the power saving options by user.
<b>Disabled</b>	Disables the Green PC Features. (Default)
<b>Min Saving</b>	Doze = 1 Hour Standby = 1 Hour Suspend = 1 Hour
<b>Max Saving</b>	Doze = 1 Min Standby = 1 Min Suspend = 1 Min
<b>PM Control by APM</b>	Choose No (Default) or Yes. APM stands for Advanced Power Management. "Yes" makes your power management more flexible.

## Installation of AMD CPU

### CPU external clock selection

Use DS3, DS4 to select CPU external clock.

External clock	DS3	DS4	Comments
50 MHz	ON	ON	50 x 1.5 = 75 for P75 50 x 1.5 = 75 for P100
55 MHz	OFF	OFF	55 x 1.5 = 83 for P90 55 x 1.5 = 83 for P100
60 MHz	OFF	ON	60 x 1.5 = 90 for P90 60 x 1.5 = 90 for P120 60 x 2 = 120 for P150
66 MHz (Default)	ON	OFF	66 x 1 = 66 for P75 66 x 1.5 = 100 for P100 66 x 1.5 = 100 for P133 66 x 2 = 132 for P166

### Clock Multiplier factor

DS1, DS2 are used to select the multiplier factor of installed CPU.

CPU internal clock = multiplier factor x external clock.

Clock multiplier factor	DS2	DS1	Comments
1	ON	OFF	66 x 1 = 66 for P75
1.5	OFF	OFF	50 x 1.5 = 75 for P75 50 x 1.5 = 75 for P100 55 x 1.5 = 83 for P90 55 x 1.5 = 83 for P100 60 x 1.5 = 90 for P90 60 x 1.5 = 90 for P120 66 x 1.5 = 100 for P100 66 x 1.5 = 100 for P133
2 (Default)	ON	OFF	60 x 2 = 120 for P150 66 x 2 = 132 for P166

### AT Bus Clock Selection

Use jumper (DS5) to select the divider factor from CPU external clock for AT Bus clock.

Divider factor	DS5
CPU external clock Divide by 8	ON (Default)
CPU external clock Divide by 6	OFF

Note: The default setting is suitable for good compatibility with ISA Add On card. You may set this jumper(DS5) to "OFF" to reach better I/O performance when your ISA Add On card can work with a little higher frequency.

### CPU Voltage

Voltage	CPU Type	JP11	JP12										
3.52V (VRE)	Reserved	<table border="1"> <tr><td>2</td><td>4</td><td>6</td></tr> <tr><td>1</td><td>3</td><td>5</td></tr> </table>	2	4	6	1	3	5	<table border="1"> <tr><td>3</td><td>4</td></tr> <tr><td>1</td><td>2</td></tr> </table>	3	4	1	2
2	4	6											
1	3	5											
3	4												
1	2												
3.38V (STD/VR) (Default)	AMD 5k86	<table border="1"> <tr><td>2</td><td>4</td><td>6</td></tr> <tr><td>1</td><td>3</td><td>5</td></tr> </table>	2	4	6	1	3	5	<table border="1"> <tr><td>3</td><td>4</td></tr> <tr><td>1</td><td>2</td></tr> </table>	3	4	1	2
2	4	6											
1	3	5											
3	4												
1	2												

### Chipset Features Setup Menu

The Chipset Features Setup Menu are used to change the parameter of the chipset internal registers. All of these parameters are hardware dependent. A wrong parameters may be caused the mainboard out of order.

Run the Chipset Features Setup as follows.

1. Choose "CHIPSET FEATURES SETUP" from the Main Menu and the following screen appears.

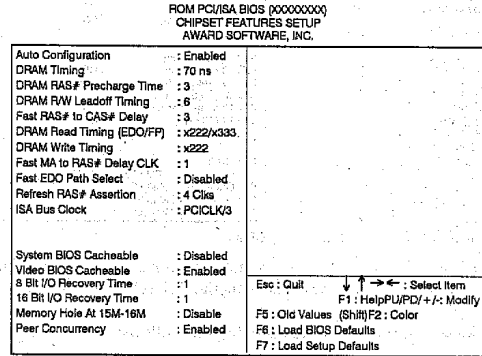

Figure 3-4 Chipset Feature Setup Menu

**Note:**

**Memory Hole At 15M-16M** Choose Enable or Disable (Default). Used to reserved memory addressing space for some special add-on-card that requires 1M byte addressing space from 15 to 16M.

2. Use the arrow keys to move between items and select values. Modify selected fields using the PgUp/PgDn/+/- keys.
3. After you have finished with the Chipset Features Setup, press the <ESC> key and follow the screen instructions to save or disregard your new settings.

- Swap Floppy Drive** Enabled changes the sequence of the A: and B: drives. (The Default setting is Disabled.)
- Boot Up Floppy Seek** Enable this item and the BIOS searches for installed floppy disk drives to determine if they are 40 tracks (360K drive) or 80 tracks (720K, 1.2M, 1.44M, or 2.88MB drives). Disable this item and the BIOS does not search for floppy drive type by track number.
- Boot Up Num Lock Status** Choose On or Off. "On" puts numeric keypad in Num Lock mode at boot-up. "Off" puts this keypad in arrow key mode at boot-up.
- IDE HDD Block Mode** This option enables/disables the IDE HDD Block Mode function. Older HDDs do not support this function. (The Default setting is Enabled.)
- Typematic Rate Setting** Enable this option to adjust the keystroke repeat rate.
- Typematic Rate (Chars/Sec)** Choose the rate a Character keeps repeating.
- Typematic Delay (Msec)** Choose how long after you press a key that a character begins repeating.
- Security Option** Choose Setup or System. Use this feature to prevent unauthorized system boot-up or use of BIOS Setup.  
 "System" - Each time the system is booted the password prompt appears.  
 "Setup" - If a password is set, the password prompt only appears if you attempt to enter the Setup program.
- PCI/VGA Palette Snoop** Choose Enable or Disable. Used to alter VGA palette setting while graphics pass through feature connector of PCI VGA card and processed by MPEG card.
- Video or Adaptor BIOS Shadow** BIOS shadow copies BIOS code from slower ROM to faster RAM. BIOS can then execute from RAM.

**Power On DRAM Refresh rate**

Use DS6 to select power on DRAM refresh rate. (Default: OFF)

**CPU Clock Selection Summary**

AMD 5k86 CPU		DRAM refresh	ISA speed	Ext. clock selection			Multiplier factor selection
CPU Type	Ext. clock	DS6	DS5	DS4	DS3	DS2	DS1
P75	50 MHz	OFF	OFF	ON	ON	OFF	OFF
P90	60 MHz	OFF	ON	ON	OFF	OFF	OFF
P100	66 MHz	OFF	ON	OFF	ON	OFF	OFF
P100	55 MHz	OFF	ON	OFF	OFF	OFF	OFF
P120	60 MHz	OFF	ON	ON	OFF	OFF	OFF
P133	66 MHz	OFF	ON	OFF	ON	OFF	OFF
P150	60 MHz	OFF	ON	ON	OFF	ON	OFF
P166	66 MHz	OFF	ON	OFF	ON	ON	OFF

**How to identify the AMD CPU**

**AMD-K5-PR100 A B Q xx**

- AMD-K5:** Processor Family
- K5** Processor Family
- A:** Package Type
- A =** SPGA (296 pin)
- PPR100:** P-rating
- 75/90/100/120/133/150/166** P-rating
- B:** Operating Voltage
- B =** 3.45V - 3.60V
- C =** 3.30V - 3.465V
- F =** 3.145V - 3.465V
- H =** 2.86V - 3.0V
- J =** 3.3V - 3.46V (core/IO)
- J =** 2.57V - 2.84V/
- K =** 3.3V - 3.46V(core/IO)
- K =** 2.38V - 2.63V/
- K =** 3.3V - 3.46V(core/IO)
- Q:** Case Temperature
- Q =** 60°C
- R =** 70°C
- W =** 55°C
- X =** 65°C
- Y =** 75°C
- Z =** 85°C

### Installation of Cyrix CPU

#### CPU external clock selection

Use DS3, DS4 to select CPU external clock.

External clock	DS3	DS4	Comments
50 MHz	ON	ON	50 x 2 = 100 for P120 +
55 MHz	OFF	OFF	55 x 2 = 110 for P133 +
60 MHz	OFF	ON	60 x 2 = 120 for P150 +
66 MHz (Default)	ON	OFF	66 x 2 = 132 for P166 +

#### Clock Multiplier factor

DS1, DS2 are used to select the multiplier factor of installed CPU.

CPU internal clock = multiplier factor x external clock.

Clock multiplier factor	DS2	DS1	Comments
1	ON	ON	(Reserved)
2 (Default)	ON	OFF	50 x 2 = 100 for P120+ (6x86) 55 x 2 = 110 for P133+ (6x86) 60 x 2 = 120 for P150+ (6x86) 66 x 2 = 132 for P166+ (6x86)
3	OFF	OFF	(Reserved)
4	OFF	ON	(Reserved)

### BIOS Features Setup Menu

The BIOS Features setup program is equipped with a series of help screens accessed by the <F1> key, which will display the available options for a particular configuration feature and special help for some of the options. If you don't really understand the meanings of each item, please don't change the following default values.

ROM PCI/ISA BIOS (XXXXXXXX)  
BIOS FEATURES SETUP  
AWARD SOFTWARE, INC.

Virus Warning	: Disabled	Video BIOS Shadow	: Enabled
CPU Internal Cache	: Enabled	C8000-CBFFF Shadow	: Disabled
External Cache	: Enabled	CC000-CFFFF Shadow	: Disabled
Quick Power on Self Test	: Enabled	D0000-D3FFF Shadow	: Disabled
Boot Sequence	: A, C	D4000-D7FFF Shadow	: Disabled
Swap Floppy Drive	: Disabled	D8000-DBFFF Shadow	: Disabled
Boot Up Floppy Seek	: Disabled	DC000-DFFFF Shadow	: Disabled
Boot Up NumLock Status	: On		
IDE HDD Block Mode	: Enabled		
TypeMatic Rate Setting	: Enabled		
TypeMatic Rate (Chars/Sec)	: 30		
TypeMatic Delay (Msec)	: 250		
Security Option	: Setup		
PCI/VGA Palette Snoop	: Disabled		

Esc: Quit    ↑ ↓ → ←: Select Item  
F1: Help    PU/PD+/ -: Modify  
F5: Old Values (Shift)F2: Color  
F8: Load BIOS Defaults  
F7: Load Setup Defaults

Figure 3-3 BIOS Feature Setup

A short description of screen items follows:

- Virus Warning**      Enable this option and a warning message appears when there is any attempt to access the boot sector or hard disk partition table.
- CPU Internal Cache**      This option enables/disables the CPU's internal cache. (The Default setting is Enabled.)
- External Cache**      This option enables/disables the external cache memory. (The Default setting is Enabled.)
- Quick Power On Self Test**      Enabled provides a fast POST at boot-up
- Boot Sequence**      The default setting attempts to first boot from drive A: and then from hard disk C:. You can reverse this sequence with "C: A:", but then drive A: cannot boot directly.

**LBA mode:** Logical Block Addressing mode is a new HDD accessing method designed to overcome the 528 Megabytes limitation. The number of cylinders, heads, and sectors shown in setup may not be the number physically contained in the HDD. During HDD accessing the IDE controller will transform the logical address described by cylinder, head, and sector number into its own physical address inside the HDD. The maximum HDD size supported by the LBA mode is 8.4 Gigabytes.

**LARGE mode:** Some IDE HDDs contain more than 1024 cylinders without LBA support. This access mode tricks DOS (or other OS) that the number of cylinders is less than 1024 by dividing it by 2. At the same time, the number of heads is multiplied by 2. The maximum HDD size supported by LARGE mode is 1 Gigabyte.

### AT Bus Clock Selection

Use jumper (DS5) to select the divider factor from CPU external clock for AT Bus clock.

Divider factor	DS5
CPU external clock Divide by 8	ON (Default)
CPU external clock Divide by 6	OFF

Note: The default setting is suitable for good compatibility with ISA Add On card. You may set this jumper (DS5) to "OFF" to reach better I/O performance when your ISA Add On card can work with a little higher frequency.

### CPU Voltage

Voltage	CPU Type	JP11	JP12										
3.52V (VRE)	Cyrix 6x86(028)	<table border="1"> <tr><td>2</td><td>4</td><td>6</td></tr> <tr><td>1</td><td>3</td><td>5</td></tr> </table>	2	4	6	1	3	5	<table border="1"> <tr><td>3</td><td>4</td></tr> <tr><td>1</td><td>2</td></tr> </table>	3	4	1	2
2	4	6											
1	3	5											
3	4												
1	2												
3.38V (STD/VR) (Default)	Cyrix 6x86	<table border="1"> <tr><td>2</td><td>4</td><td>6</td></tr> <tr><td>1</td><td>3</td><td>5</td></tr> </table>	2	4	6	1	3	5	<table border="1"> <tr><td>3</td><td>4</td></tr> <tr><td>1</td><td>2</td></tr> </table>	3	4	1	2
2	4	6											
1	3	5											
3	4												
1	2												

### Power On DRAM Refresh rate

Use DS6 to select power on DRAM refresh rate. (Default: OFF)

### CPU Clock Selection Summary

Cyrix 6x86 CPU		DRAM refresh	ISA speed	Ext. clock selection			Multiplier factor selection	
CPU Type	Ext. clock	DS6	DS5	DS4	DS3	DS2	DS1	
P120+	50 MHz	OFF	OFF	ON	ON	ON	OFF	
P133+	55 MHz	OFF	ON	OFF	OFF	ON	OFF	
P150+	60 MHz	OFF	ON	ON	OFF	ON	OFF	
P166+	66 MHz	OFF	ON	OFF	ON	ON	OFF	

## Installation of Memory

The mainboard provides four 72-pin SIMM sites for memory expansion. The sockets support 1M x 32 (4MB), 2M x 32 (8MB), 4M x 32 (16MB), and 8M x 32 (32MB) single-side or double-side SIMM modules. Minimum memory size is 8 MB and maximum memory size, using four 8M x 32 SIMM modules, is 128MB.

There are two banks of Memory (Bank0 to Bank1) on the system board. Each bank consists of two 72pin SIMM sockets.

Table 2-1 shows the possible memory combinations. The mainboard will support both Fast Page DRAM or EDO DRAM SIMMs, but they cannot be mixed within the same memory bank. If Fast Page DRAM and EDO DRAM SIMMs are installed in separate banks, each bank will be optimized for maximum performance. Parity generation and detection is NOT supported. SIMM requirements are 70ns Fast Page Mode or EDO DRAM with tin-lead connectors.

SIMM 1, 2(Bank 0)	SIMM 3, 4(Bank 1)	Total
Empty	1M x 32 (4MB)	8MB
Empty	2M x 32 (8MB)	16MB
Empty	4M x 32 (16MB)	32MB
Empty	8M x 32 (32MB)	64MB
Empty	16M x 32 (64MB)	128MB
1M x 32 (4MB)	Empty	8MB
1M x 32 (4MB)	1M x 32 (4MB)	16MB
1M x 32 (4MB)	2M x 32 (8MB)	24MB
1M x 32 (4MB)	4M x 32 (16MB)	40MB
1M x 32 (4MB)	8M x 32 (32MB)	72MB
2M x 32 (8MB)	Empty	16MB
2M x 32 (8MB)	1M x 32 (4MB)	24MB
2M x 32 (8MB)	2M x 32 (8MB)	32MB
2M x 32 (8MB)	4M x 32 (16MB)	48MB
2M x 32 (8MB)	8M x 32 (32MB)	80MB
4M x 32 (16MB)	Empty	32MB
4M x 32 (16MB)	1M x 32 (4MB)	40MB
4M x 32 (16MB)	2M x 32 (8MB)	48MB
4M x 32 (16MB)	4M x 32 (16MB)	64MB
4M x 32 (16MB)	8M x 32 (32MB)	96MB

## Standard CMOS Setup Menu

The items in Standard CMOS Setup Menu are divided into several categories. Each category includes none, one, or more than one setup items. Use the arrow keys to highlight the item and then use the <PgUp> or <PgDn> keys to select the value you want in each item.

Date (mm/dd/yy) : Wed Apr 21 1993								
Time (hh:mm:ss) : 14:53:31								
HARDS DISKS	Type	SIZE	CYLS	HEAD	PRECOMP	LANDZ	SECTOR	MODE
Primary Master	: None	0	0	0	0	0	0	-----
Primary Slave	: None	0	0	0	0	0	0	-----
Secondary Master	: None	0	0	0	0	0	0	-----
Secondary Slave	: None	0	0	0	0	0	0	-----
Drive A: 1.44M, 3.5 in.								
Drive B: None								
Video : EGA/VGA				Base Memory: 640K				
Halt On : All, But Keyboard				Expanded Memory: 3328K				
				Other Memory: 0K				
				Total Memory: 4096K				
Esc : Quit		↓ ↑ ← → : Select Item			PLU/PD/+/=: Modify			
F1 : Help		(Shift)F2 : Change Color			F3 : Toggle Calendar			

Figure 3-2 Standard CMOS Setup Menu

The setup program is completely menu-driven:

1. Use arrow keys to select entry of **Date, Time, Hard Disk, Floppy, Display and Keyboard**.
2. Use **PgUp/PgDn** key to modify the options of each entry.
3. Use **Esc** to exit.

### Hard Disk size selection

The Award BIOS supports three HDD modes: **NORMAL**, **LBA**, and **LARGE**.

**NORMAL mode**: The maximum HDD size supported by the **NORMAL** mode is 528 Megabytes.

is displayed. If the [Del] key or Ctrl-Alt-Esc is pressed, the screen will be cleared and then the following message will be shown:

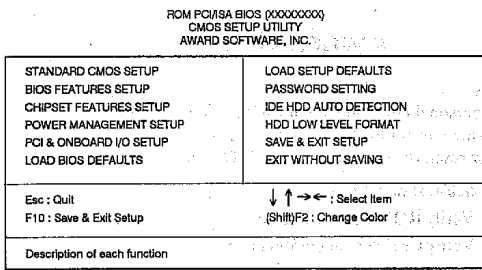

Figure 3-1 Main Menu

SIMM 1, 2(Bank 0)	SIMM 3, 4(Bank 1)	Total
8M x 32 (32MB)	Empty	64MB
8M x 32 (32MB)	1M x 32 (4MB)	72MB
8M x 32 (32MB)	2M x 32 (8MB)	80MB
8M x 32 (32MB)	4M x 32 (16MB)	96MB
8M x 32 (32MB)	8M x 32 (32MB)	128MB

Table 2-1



---

## Chapter 3

---

### Award BIOS Setup

All personal computer use a BIOS, or Basic Input/Output system, to provide control for the hardware functions. When system is powered on or reset, the CPU is reset and BIOS will do the following:

- Self-test on CPU.
- Verify ROM BIOS checksum.
- Verify CMOS configuration chip.
- Initialize timer.
- Initialize DMA controller.
- Verify system memory and cache memory.
- Install all BIOS function call utilities.
- Verify/initialize all system configurations, like keyboard, floppy drive, hard disk, initialize EGA or VGA if there is any.
- Hook to the add-in BIOS (include NCR and AHA PCI SCSI BIOS) or expansion BIOS to perform initialization and driver link to the system.

Award's BIOS ROM has a built-in setup program that allows users to modify the basic system configuration. This type of information is stored in battery-backed RAM so that the setup information is retained when the power is turned off. When the system is powered on or reset, the Award BIOS will display a copyright message on the screen, then the BIOS will perform the system diagnostics test and initialization. When all of the above tests have been passed, the message:

**"TO ENTER SETUP BEFORE BOOT PRESS CTRL-ALT-  
ESC OR DEL KEY"**