

Premiere/PCI Baby-AT Board & Expandable Desktop

Technical Product Summary

Comentario [BK1]: Page: 1

Version 3.0

January, 1995

Order Number 281604-003

intel®

Premiere/PCI Expandable Desktop Technical Product Summary

Table of Contents

Introduction	3
Board Level Features	4
CPU	
Performance Upgrade	
Second Level Cache	
System Memory	
Expansion Slots	
Peripheral Component Interconnect (PCI) Chip Set	
RZ1000 PCI IDE Interface	
SMC 37C665 Super I/O Controller	
Keyboard Interface	
Dallas DS12887 Real Time Clock, CMOS RAM and Battery	
System BIOS	
Connectors	
System Level Features.....	11
Chassis	
Peripheral Bays	
Fan	
Expansion Slots	
Front Panel	
Back Panel	
Power Supply	
Power Consumption	
Floppy Drive	
Speaker	
Chassis Color	
Premiere/PCI MiniTower Chassis	13
Appendix A – User-Installable Upgrades.....	14
Appendix B – Jumpers.....	15
Appendix C – Connectors.....	16
Appendix D – Memory Map.....	20
Appendix E – I/O Map.....	20
Appendix F – Interrupts & DMA Channels	21
Appendix G – AMIBIOS Setup.....	22
Appendix H – AMIBIOS Error messages and Beep Codes.....	32
Appendix I – BIOS Recovery	35
Appendix J – Environmental Standards	36
Appendix K – Reliability Data	36
Appendix L – Customer Support.....	37

Intel Corporation disclaims all warranties and liabilities for the use of this document and the information contained herein, and assumes no responsibility for any errors which may appear in this document. Intel makes no commitment to update the information contained herein, and may make changes at any time without notice. There are no express or implied licenses granted hereunder to any intellectual property rights of Intel Corporation or others to design or fabricate Intel integrated circuits or integrated circuits based on the information in this document. Contact your local sales office to obtain the latest specifications before placing your order.

*All other trademarks are the property of their respective owners.

© INTEL CORPORATION, 1995

Introduction

The Premiere/PCI Expandable Desktop is a state-of-the-art platform delivering the latest Pentium™ microprocessor and I/O technology on an industry-standard Baby-AT form factor motherboard. It is ideal for demanding desktop applications requiring the maximum in I/O expansion flexibility.

A 60 MHz or 66 MHz Pentium microprocessor is complemented by a 256 KB second level write-back cache to provide workstation-level computing performance. A Pentium OverDrive™ socket provides access to future performance enhancements, and SIMM sockets support up to 128 MB of system memory.

The Premiere/PCI Baby-AT motherboard offers outstanding I/O capabilities. Three PCI local bus slots provide a high bandwidth data path for data-intensive functions such as graphics and disk I/O. Integrated peripherals include the RZ1000, which provides a PCI local bus primary IDE interface, as well as the SMC 37C665 Super I/O component, which provides floppy and secondary IDE drive interfaces, two FIFO serial ports and an ECP-capable parallel port. Five ISA slots complete the I/O mix.

STANDARD BABY-AT FORM FACTOR

The Premiere/PCI Baby-AT motherboard conforms to the industry standard Baby-AT form factor. It meets the specifications for maximum board size, board mounting locations, expansion slot placement, and keyboard connector location. In addition to complying to the standard, the Premiere/PCI Baby-AT provides three slots which will accommodate PCI expansion cards.

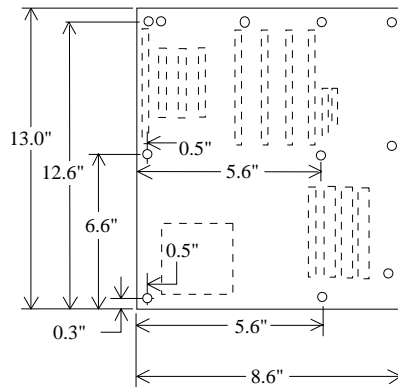

Figure 1. Premiere/PCI Baby-AT Motherboard dimensions.

Board Level Features

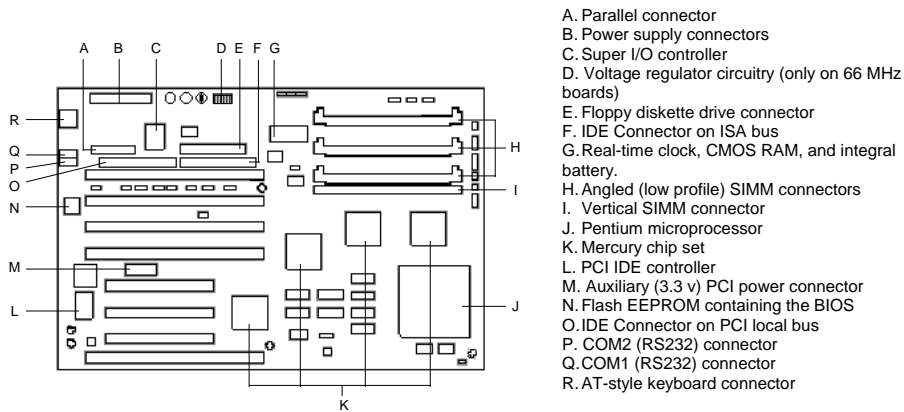

Figure 2. Premiere/PCI Baby-AT Motherboard components

CPU

The Premiere/PCI Baby-AT motherboard is designed to operate with either a 60 MHz or 66 MHz Pentium microprocessor. This processor is compatible with the 8086, 80286, i386™ and i486™ CPUs. It supports both read and write burst mode bus cycles, and includes an on-chip 16 KB cache which is split into 8 KB code and 8 KB data caches employing a write-back policy. The Pentium processor also integrates an advanced numeric coprocessor which significantly increases the speed of floating point operations, while maintaining compatibility with i486™DX math coprocessors and complying with ANSI/IEEE standard 754-1985.

Premiere/PCI Baby-AT motherboards equipped with 66 MHz Pentium processors have a voltage control circuit that regulates Vcc to the CPU and frequency synthesizer. The voltage regulation accommodates a variety of Intel CPUs and increases the overall robustness and reliability of the motherboard. Boards without the voltage regulator circuitry cannot reliably use 66 MHz Pentium processors.

The motherboard contains two mounting holes which allow a dedicated fan to be located directly in front of the CPU socket. A 12 volt connector suitable for a CPU fan is located close to the mounting holes

PERFORMANCE UPGRADE

A 273-pin Type 4 Zero Insertion Force socket provides users with a performance upgrade path using Pentium OverDrive processors. The OverDrive processor being developed for use in this socket will provide performance beyond that delivered by the Pentium microprocessor.

Comentario [DDS2]: Add info about Pentium overdrive chips in future revision.

SECOND LEVEL CACHE

The Pentium processor's internal cache is complemented with a 256 KB direct mapped, write-back second level cache implemented with eight 32Kx8, 15 ns SRAM devices. Tag and control logic is contained in the 82434LX PCMC core chip.

SYSTEM MEMORY

The Premiere/PCI motherboard provides four 72-pin SIMM sites for memory expansion. The sockets support 256K x 36 (1 MB), 512K x 36 (2 MB), 1M x 36 (4 MB), 2M x 36 (8 MB), 4M x 36 (16 MB), and 8M x 36 (32 MB) SIMM modules. Minimum memory size is 2 MB and maximum memory size, using four 8M x 36 SIMM modules, is 128 MB. Memory timing requires 70 ns fast page devices. Parity generation/checking is provided for each byte. Non-parity 32 bit SIMMs also may be used, in which case the parity generation/checking circuitry is automatically disabled.

The four sockets are arranged as Bank A and Bank B, with each bank consisting of two sockets and providing a 64-bit wide data path and 8 parity bits. Both SIMMs in a bank must be of the same memory size and type, although Banks A and B may have different types of memory installed. Bank A only, Bank B only, or both banks may be populated. There are no jumper settings required for the memory size, which is automatically detected by the system BIOS. Tin-lead SIMMs should be used when adding DRAM.

The memory array is controlled by the Intel 82434LX PCMC and data buffering is provided by two Intel 82433LX Local Bus Extension devices.

EXPANSION SLOTS

Up to seven expansion slots may be populated on the Premiere/PCI Baby-AT motherboard. Expansion cards are oriented perpendicular to the motherboard.

There are five ISA bus expansion connectors and three PCI expansion connectors. One slot is shared by connectors that will accommodate either an ISA or a PCI expansion card, but not both at the same time. All three PCI expansion slots accept PCI master cards to fully support the PCI specification.

The motherboard design limits the length of add-in cards in some slots. The height of the CPU heat sink limits the use of the two PCI connectors at J10C1 and J10C2 to less than full-length devices. The length of cards installed in the ISA connector at J10F1 may be limited if a SIMM is installed in the vertical SIMM socket (J3F1). And the location of the serial port header may limit the type of card that can be installed in the ISA connector at J10G1.

PCI 3.3 VOLT CAPABILITIES

To maintain strict compliance with the PCI specification, the motherboard provides a connector which can be used to route 3.3 volt power to the PCI slots. The connector may be used with a separate 3.3 volt power supply or with a custom designed voltage converter.

PERIPHERAL COMPONENT INTERCONNECT (PCI) CHIP SET

The Intel Mercury chip set consists of one 82434LX PCI/Cache/Memory Controller (PCMC), two 82433LX Local Bus eXtension (LBX) devices, and one 82378IB System I/O (SIO) bridge chip. The Mercury chip set provides the following functions:

- CPU reset control
- CPU L1 cache control
- CPU burst mode control
- CPU interface control
- Integrated second level write-back cache controller with tag comparator
- Fast Page-mode DRAM controller
- Burst memory read/write control logic
- Data bus conversion to PCI
- Parity generation/detection to memory
- AT-BUS direction control
- Chip select for keyboard controller and RTC
- Speaker control
- NMI logic
- Floating-point coprocessor interface
- Keyboard reset, gate A20 emulation logic
- DMA controller
- Interrupt controller
- Counters/Timers

82434LX PCI/CACHE/MEMORY CONTROLLER (PCMC)

The 82434LX provides all control signals necessary to drive a second level cache and the DRAM array, including multiplexed address signals. It also controls system access to memory and generates snoop controls to maintain cache coherency.

82433LX LOCAL BUS EXTENSION (LBX)

There are two 82433LX components which provide data bus buffering and dual port buffering to the memory array. Controlled by the 82434LX, the 82433LX devices add one load each to the PCI bus and perform all the necessary byte and word swapping. The devices include memory and I/O write buffers.

82378IB SYSTEM I/O (SIO)

The 82378IB integrates seven 32-bit DMA channels, five 16-bit timer/counters, two eight-channel interrupt controllers, NMI logic, ISA refresh address generation, and PCI/ISA bus arbitration circuitry together onto the same device.

Detailed information on the chip set is available in the Intel 82430 PCISet data sheet.

RZ1000 PCI IDE INTERFACE

The Premiere/PCI Baby-AT motherboard offers two IDE channels: one on the PCI local bus and one on the ISA bus. PCI-based IDE provides performance much improved over the traditional ISA-based IDE.

PCI TO IDE INTERFACE CIRCUIT

An onboard PCI to IDE interface is provided by the PCTech RZ1000 component and a specially-tuned system BIOS, which is fully compatible with existing IDE software. The RZ1000 provides a 32-bit buffered interface to two IDE drives, allowing these drives to be accessed at full PCI bandwidth. The component also supports Enhanced IDE Mode 3 timing, allowing the drive to transfer data at its full bandwidth. The system BIOS provides transparent access to these features, as well as support for Logical Block Addressing (LBA) which allows the use of drives larger than 528 MB. The PCI IDE interface functions as the primary interface using Interrupt 14. A secondary IDE interface (IRQ15) is provided by the SMC 37C665 I/O controller.

IDE PHYSICAL INTERFACE

The PCI IDE physical interface consists of a dedicated 40-pin header connector (J11F1). A separate 40-pin connector (J9G1) is dedicated to the SMC 37C655 IDE interface. When the on-board IDE controllers are enabled, the RZ1000 is the primary interface and the ISA IDE controller is the secondary interface.

SMC 37C665 SUPER I/O CONTROLLER

Control for the integrated serial ports, parallel port, floppy drive and ISA IDE hard drive interface is incorporated into a single component, the SMC FDC37C665. This component provides:

- Two NS16C552-compatible UARTs with send/receive 16 byte FIFO
- Multi-mode bi-directional parallel port
 - Standard mode; IBM* and Centronics compatible
 - Enhanced Parallel Port (EPP) with BIOS/Driver support
 - High Speed mode; Extended Capabilities Port (ECP) compatible
- Industry standard floppy controller with 16 byte data FIFO (2.88 MB floppy support)
- IDE hard disk decode and chip select

Header pins located near the back of the board allow cabling to use these interfaces. The serial ports can be set to various addresses or disabled. The parallel port can be configured via the Setup program for various addresses or disabled, and can be set as bi-directional or output only when enabled.

KEYBOARD INTERFACE

An Intel 8742 surface mount microcontroller contains the Phoenix Technologies-compatible keyboard/mouse controller code. An AT-style keyboard connector is located on the back panel side of the motherboard. The 5V line on this connector is protected with a PolySwitch* circuit which acts much like a self-healing fuse, re-establishing the connection after an over-current condition is removed. While this device eliminates the possibility of having to replace a fuse, care should be taken to turn off the system power before installing or removing a keyboard.

The 8742 microcontroller code supports Power-On/Reset (POR) password protection. The POR password is set via the Setup program. The keyboard controller also provides for the following "hot key" sequences:

- CTRL-ALT-DEL: System software reset. This sequence performs a software reset of the system by jumping to the beginning of the BIOS code and running the POST operation.
- CTRL-ALT+ and CTRL-ALT-: Turbo mode selection. CTRL-ALT- sets the system for de-turbo mode (emulation of an 8 MHz 80286 CPU) and CTRL-ALT+ sets the system for turbo mode (normal operation at 60 MHz). Changing the Turbo mode may be prohibited by an operating system or application software. For example, the CPU speed cannot be changed with the hot keys when the CPU is in Protected Mode.

DALLAS DS12887 REAL TIME CLOCK, CMOS RAM AND BATTERY

The Real Time Clock (RTC) is implemented using a Dallas DS12887 device. The DS12887 is accurate to within 13 minutes/year and requires no external support (the battery and oscillator are integrated into the device). The internal battery has an estimated lifetime of ten years.

The RTC can be set via the BIOS SETUP Program. CMOS memory supports the standard 128-byte battery-backed RAM, fourteen bytes for clock and control registers, and 114 bytes of general purpose non-volatile CMOS RAM. All CMOS RAM is reserved for BIOS use. The CMOS RAM can be set to specific values or cleared to the system default values using the BIOS SETUP program. Also, the CMOS RAM values can be cleared to the system defaults by using a hardware jumper.

SYSTEM BIOS

The Premiere/PCI Baby-AT motherboard uses an American Megatrends Incorporated (AMI) ROM BIOS, which is stored in Flash EEPROM and easily upgraded using a floppy disk-based program. BIOS upgrades will be available for download from the Intel bulletin board system. In addition to the AMIBIOS, the Flash EEPROM also contains the Setup utility, Power-On Self Tests (POST), update recovery code, and the PCI auto-configuration utility. This motherboard supports system BIOS shadowing, allowing the BIOS to execute from 32-bit on-board write-protected DRAM.

The BIOS displays a sign-on message during POST identifying the type of BIOS and a five-digit revision code. First production units will display a revision code of 1.00.01.AF2. As BIOS updates occur, the revision number will increase to 1.00.02.AF2, and so on.

Information on BIOS functions can be found in the *IBM PS/2 and Personal Computer BIOS Technical Reference* published by IBM, and the *ISA and EISA Hi-Flex AMIBIOS Technical Reference* published by AMI. Both manuals are available at most technical bookstores.

FLASH IMPLEMENTATION

The Intel 28F001BXT 1 Mb FLASH component is organized as 128K x 8 (128 KB). The Flash device is divided into five areas, as described in Table 1.

System Address		FLASH Memory Area
F0000H	FFFFFH	64 KB Main BIOS
EE000H	EFFFFH	8 KB Boot Block (Not FLASH erasable)
ED000H	EDFFFH	4 KB ECSD Area (Plug and Play data)
EC000H	ECFFFH	4 KB BIOS Logo Area
E0000H	EBFFFH	48 KB Not Used

Table 1. Flash Memory Organization

The FLASH device resides in system memory in two 64 KB segments starting at E0000H, and can be mapped two different ways, depending on the mode of operation. In *Normal Mode*, address line A16 is inverted, setting the E000H and F000H segments so that the BIOS is organized as shown in the system address column above. *Recovery mode* removes the inversion on address line A16, swapping the E000H and F000H segments so that the 8 KB boot block resides at FE000H where the CPU expects the bootstrap loader to exist. This mode is only necessary in the unlikely event that a BIOS upgrade procedure is interrupted, causing the BIOS area to be left in an unusable state. For information on recovering the BIOS in the event of a catastrophic failure, refer to the appendix on BIOS Upgrades and Recovery.

BIOS UPGRADES

Flash memory makes distributing BIOS upgrades easy. A new version of the BIOS can be installed from a diskette. BIOS upgrades will be available from the bulletin board system for Authorized Distributors and direct Intel customers.

The disk-based Flash upgrade utility (FMUP.EXE) has three options for BIOS upgrades:

- The Flash BIOS can be updated from a file on a disk;
- The current BIOS code can be copied from the Flash EEPROM to a disk file as a backup in the event that an upgrade cannot be successfully completed; or
- The BIOS in the Flash device can be compared with a disk file to ensure the system has the correct BIOS version.

The upgrade utility ensures the upgrade BIOS matches the target system to prevent accidentally installing a BIOS for a different type of system. Security to prevent unauthorized changes to the BIOS is provided via a write-protect jumper. The default setting is to allow BIOS upgrades. A recovery jumper is provided to allow recovery in the unlikely event of an unsuccessful BIOS upgrade. The jumper forces the ROM decode to access an 8 KB block of write protected recovery code in the Flash device.

SETUP UTILITY

The ROM-based Setup utility allows the configuration to be modified without opening the system for most basic changes. The Premiere/PCI Baby-AT motherboard also incorporates many new capabilities into the Flash EEPROM, including:

- Auto configuration of IDE hard disks (manual selection of the drive type is no longer required).
- Support for two IDE disk interfaces (primary and secondary) providing access to four IDE devices (when a second IDE controller is used on the PCI or ISA bus).
- An option allowing the user to assign a block of addresses below the 1 MB boundary as non-shadowed, non-cached. This area is primarily used for expansion card ROM which causes timing problems when shadowed and cached.
- ISA interrupts may be assigned to add-in card ISA adapters, thereby informing the PCI configuration utility which interrupts not to use.

The Setup utility is accessible only during the Power-On Self Test (POST) by pressing the or <F1> key after the POST memory test has begun and before boot begins. A prompt may be enabled that informs users to press the <F1> key to access Setup. A motherboard jumper can be set to prevent user access to Setup for security purposes. Setup options are detailed in Appendix G.

PCI AUTO-CONFIGURATION CAPABILITY

The PCI auto-configuration utility operates in conjunction with the system Setup utility to allow the insertion and removal of PCI cards to the system without user intervention. When the system is turned on after adding a PCI add-in card, the BIOS automatically configures interrupts, I/O space, and other parameters. The user does not have to configure jumpers or worry about potential resource conflicts. Because PCI cards use the same interrupt resources as ISA cards, the user must specify the interrupts used by ISA add-in cards in the Setup utility or use a Plug and Play Configuration Utility. The PCI Auto-Configuration function complies with version 2.0G of the PCI BIOS specification.

ISA PLUG AND PLAY CAPABILITY

The Premiere/PCI Expandable Desktop fully supports the ISA Plug and Play standard Version 1.1. This will allow auto-configuration of Plug and Play ISA cards, and resource management for legacy ISA cards, when used in conjunction with the ICU (ISA Configuration Utility). Copies of the IAL Plug and Play specification may be obtained via FaxBack (800) 628-2283, or via CompuServe by typing Go PlugPlay. System configuration data is stored in the on-board Flash device.

SECURITY FEATURES

BIOS Password

A BIOS password feature provides security during the boot process. A password can be entered using the Setup utility and must be re-entered prior to disk boot each time the system is reset. To enable, disable, or change the password, refer to the Setup program options in Appendix G.

If the password is forgotten, it can be cleared by turning off the system and setting the "password clear" jumper to the clear position.

Setup Enable Jumper

A baseboard jumper controls access to the BIOS Setup utility. By setting jumper to the disable position, the user is prevented from accessing the Setup utility at any time.

CONNECTORS

FRONT PANEL CONNECTIONS

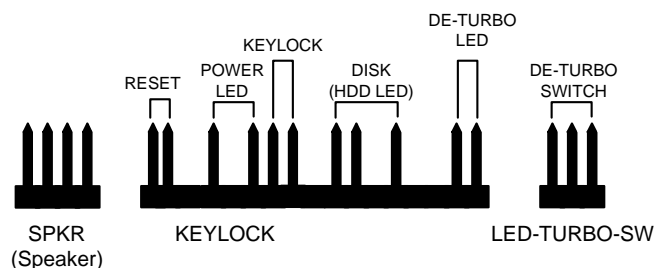

Figure 3: Front Panel Connectors

Figure 3 shows connectors provided on the motherboard for various functions. See the appendix for pin assignments.

The external speaker provides error beep code information during the Power-On Self Test if the system cannot use the video interface. See the appendix for more information about error beep codes.

BACK PANEL CONNECTIONS

The Premiere/PCI Baby-AT includes an AT-style keyboard connector integrated on the back panel side of the motherboard.

I/O CONNECTIONS

The motherboard contains stake pin header connections for cabling the serial, parallel, floppy, and IDE interfaces. Figure 4 shows the locations of these connectors, orientation of pin 1 on each, the numbering of each connector, and for IDE and Floppy, the missing key pin.

Fast Fan is the default connection and provides 12V power for operating the fan. For slower and quieter fan operation (less cooling), the Slow Fan connector provides 10V power.

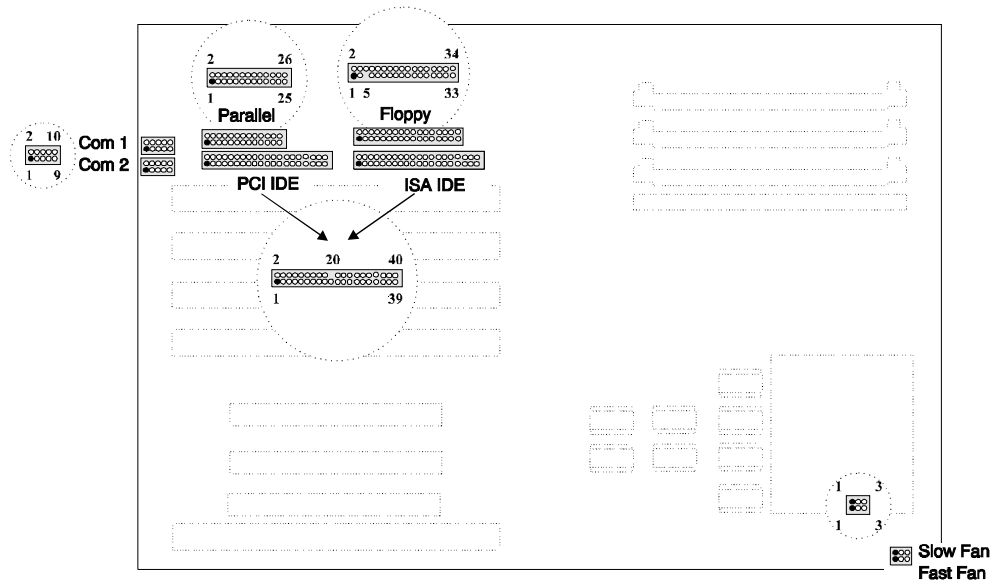

Figure 4. I/O Connections

System Level Features

CHASSIS

The Expandable Desktop chassis easily provides the expandability required for most traditional PC applications – seven peripheral bays, seven expansion slots, an ample 200 watt power supply and an additional fan located at the front left side of the chassis to help keep the system cool. The user can access five of the peripheral bays from the front of the chassis. The Expandable Desktop chassis also meets stringent environmental requirements.

PERIPHERAL BAYS

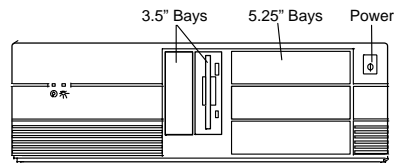

Figure 5: Premiere/PCI Expandable Desktop Front Panel

Seven expansion bays are available for peripherals and other add-in devices. These include three 5¼" half-height bays and two 3½" one-inch bays that are accessible from the front panel. Two internal 3½" peripheral bays are located above the power supply.

FAN

The Expandable Desktop chassis has two fans to keep the system cool. One fan within the power supply provides 28 cfm of air movement. The second fan, located behind the card guide, provides 26 cfm across the add-in cards and the CPU. The second fan receives 12 Vdc directly from the baseboard.

EXPANSION SLOTS

The Expandable Desktop chassis has seven expansion card slots, as shown in Figure 6. Several of the slots are intended for use with less than full-length cards. One ISA slot is limited in length by the 3½" peripheral bay carrier, one ISA card slot is limited in length by the left-most SIMM socket, two ISA card slots are full length, two PCI slots are limited in length by the CPU heatsink, and one is a full length shared slot, accepting either an ISA or a PCI expansion card.

FRONT PANEL

The Expandable Desktop chassis front panel consists of a power switch, a power-on LED and a hard disk access LED. Five peripheral bays also can be accessed from the front panel, as shown in Figure 5.

BACK PANEL

The back panel consists of access panels for the expansion slots (one location is unused), two DB9 RS-232 serial ports, a bi-directional parallel port, an AT-style keyboard connector, a 115/230 voltage switch, a power supply input, an auxiliary power output and the power supply fan. Punch-out locations also are provided for adding a second parallel port and a SCSI-2 connector.

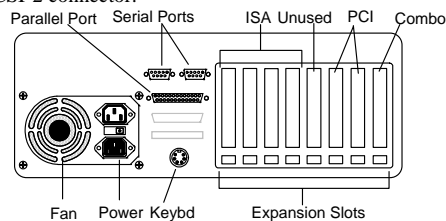

Figure 6: Premiere/PCI Expandable Desktop Back Panel.

POWER SUPPLY

The Premiere/PCI Expandable Desktop integrates a 200 watt switchable power supply for all onboard resources, add-in cards, and peripherals. The Astec Corp. model SA201-3440 supports operating settings at 100-120 VAC (5 Amps AC) or 200-240 VAC (3 Amps AC). The input voltage is selected using a switch on the back of the system.

AC POWER INPUT SPECIFICATIONS

<i>Input frequency 50/60 Hz</i>	
<i>AC Voltage</i>	<i>Current</i>
90-135	4.0 A
180-265	2.0 A

Table 2. Power Supply Input Specifications.

DC OUTPUT SPECIFICATIONS

<i>DC Voltage</i>	<i>Max. Continuous Current</i>	<i>Peak Current 15 Seconds</i>	<i>Minimum Current Load</i>
+5V	22.0A	-	3.0A
-5V	0.5A	-	0A
+12V	8.0A	10.0 A	0.5A
-12V	1.0A	-	0A

Table 3. Power Supply DC Output Specifications.

POWER CONSUMPTION

Table 4 lists the current used by motherboard resources in a configuration which includes 8 MB of DRAM and no expansion cards. Table 5 lists the typical power consumed by the same configuration. This information is preliminary and is provided only as a guide for calculating approximate total system power usage with additional resources added. Refer to vendor documentation for peripherals and expansion cards to determine those current requirements.

CURRENT

<i>DC Voltage</i>	<i>Max. Continuous Current</i>	<i>Peak Current 15 Seconds</i>	<i>Minimum Current Load</i>
+5V	2.6A	2.6A	2.0A
-5V	0A	0A	0A
+12V	2.9A	2.9A	0.5A
-12V	0.1A	0.1A	0A

Table 4. Premiere/PCI Expandable Desktop Current Requirements

WATTS

<i>Resource</i>	<i>Typical Power</i>
Premiere/PCI Expandable Desktop baseboard, 8 MB , 256 KB cache	30 watts
Teac 3½" Floppy drive	1.7 watts

Table 5. Current Use by System Resources

FLOPPY DRIVE

The Premiere/PCI Expandable Desktop integrates a 3½" Teac Floppy drive Model FD-235HF into the right 3½" bay. This is the same proven floppy disk drive that has been used on many previous Intel systems.

SPEAKER

The standard system ships with an external speaker installed. The user may enable/disable the device using the Setup utility or program the speaker via port 61H. The speaker provides error beep code information during POST if the system cannot use the video interface. The Premiere/PCI Expandable Desktop product guide (order # 616545) contains detailed beep and error code information.

CHASSIS COLOR

The chassis color is beige. The bottom and back of the chassis are not painted.

Premiere/PCI MiniTower Chassis

The Premiere/PCI Baby-AT motherboard also is available in Intel's MiniTower chassis, which provides an ideal platform for multimedia applications that require integration of CD-ROM, sound cards, graphics and video solutions and high performance communications cards.

Expandability is provided for most traditional and emerging PC applications, including seven peripheral bays (four external and three internal). A solid 200 watt power supply and an additional fan located behind the front grill provides all of the power and cooling requirements needed to support future generations of Intel's Pentium and OverDrive processors.

The MiniTower chassis has been designed to offer the maximum in flexibility, ease of integration and maintenance. Two screws secure a sliding side panel that provides access to the inside of the chassis. The enclosure also meets stringent environmental requirements.

The chassis dimensions are: 16.0" (40.6 cm) high with feet, 8.3" (21 cm) wide, 18.1" (46 cm) deep with bezel. The weight without peripherals is 21.4 lbs (9.79 kgs).

Appendix A – User-Installable Upgrades

SYSTEM MEMORY

Table A-1 shows the possible memory combinations. The Premiere/PCI Baby-AT motherboard supports both parity and non-parity SIMMs, but they cannot be mixed within the same memory bank. SIMM requirements are 70ns, Fast Page Mode, with tin-lead connectors.

<i>SIMM 1,2 (Bank 0)</i> <i>SIMM Type (Amount)</i>	<i>SIMM 3,4 (Bank 1)</i> <i>SIMM Type (Amount)</i>	<i>Total System Memory</i>
256K X 36 (1 MB)	Empty	2 MB
256K X 36 (1 MB)	256K X 36 (1 MB)	4 MB
256K X 36 (1 MB)	512K X 36 (2 MB)	6 MB
256K X 36 (1 MB)	1M X 36 (4 MB)	10 MB
256K X 36 (1 MB)	2M X 36 (8 MB)	18 MB
256K X 36 (1 MB)	4M X 36 (16 MB)	34 MB
256K X 36 (1 MB)	8M X 36 (32 MB)	66 MB
512K X 36 (2 MB)	Empty	4 MB
512K X 36 (2 MB)	256K X 36 (1 MB)	6 MB
512K X 36 (2 MB)	512K X 36 (2 MB)	8 MB
512K X 36 (2 MB)	1M X 36 (4 MB)	12 MB
512K X 36 (2 MB)	2M X 36 (8 MB)	20 MB
512K X 36 (2 MB)	4M X 36 (16 MB)	36 MB
512K X 36 (2 MB)	8M X 36 (32 MB)	68 MB
1M X 36 (4 MB)	Empty	8 MB
1M X 36 (4 MB)	256K X 36 (1 MB)	10 MB
1M X 36 (4 MB)	512K X 36 (2 MB)	12 MB
1M X 36 (4 MB)	1M X 36 (4 MB)	16 MB
1M X 36 (4 MB)	2M X 36 (8 MB)	24 MB
1M X 36 (4 MB)	4M X 36 (16 MB)	40 MB
1M X 36 (4 MB)	8M X 36 (32 MB)	72 MB
2M X 36 (8 MB)	Empty	16 MB
2M X 36 (8 MB)	256K X 36 (1 MB)	18 MB
2M X 36 (8 MB)	512K X 36 (2 MB)	20 MB
2M X 36 (8 MB)	1M X 36 (4 MB)	24 MB
2M X 36 (8 MB)	2M X 36 (8 MB)	32 MB
2M X 36 (8 MB)	4M X 36 (16 MB)	48 MB
2M X 36 (8 MB)	8M X 36 (32 MB)	80 MB
4M X 36 (16 MB)	Empty	32 MB
4M X 36 (16 MB)	256K X 36 (1 MB)	34 MB
4M X 36 (16 MB)	512K X 36 (2 MB)	36 MB
4M X 36 (16 MB)	1M X 36 (4 MB)	40 MB
4M X 36 (16 MB)	2M X 36 (8 MB)	48 MB
4M X 36 (16 MB)	4M X 36 (16 MB)	64 MB
4M X 36 (16 MB)	8M X 36 (32 MB)	96 MB
8M X 36 (32 MB)	Empty	64 MB
8M X 36 (32 MB)	256K X 36 (1 MB)	66 MB
8M X 36 (32 MB)	512K X 36 (2 MB)	68 MB
8M X 36 (32 MB)	1M X 36 (4 MB)	72 MB
8M X 36 (32 MB)	2M X 36 (8 MB)	80 MB
8M X 36 (32 MB)	4M X 36 (16 MB)	96 MB
8M X 36 (32 MB)	8M X 36 (32 MB)	128 MB

Table A-1. Possible SIMM Memory Combinations

Appendix B – Jumpers

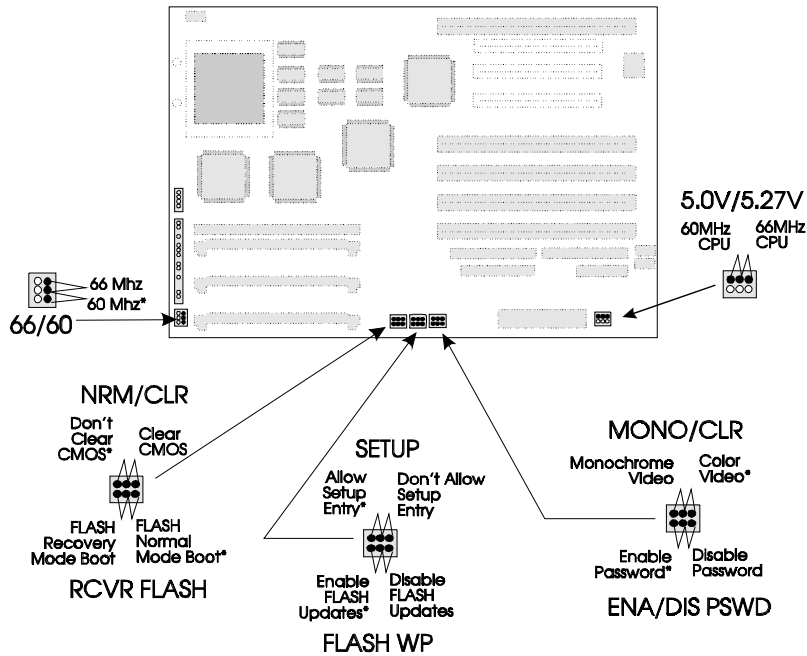

Figure B-1. Jumper locations and settings (*denotes default setting)

66/60

This jumper is set at the factory for the appropriate CPU clock frequency and may not be changed by the user. If changed from the factory setting, improper operation may result.

FLASH RECOVERY (RCVR FLASH)

Allows recovery if the system FLASH update process results in corrupted EPROM.

CLEAR CMOS (NRM/CLR)

Allows CMOS settings to be reset to default values.

SETUP ENABLE (SETUP)

Allows access to CMOS Setup Utility to be disabled.

FLASH WRITE PROTECT (FLASH WP)

Allows reprogramming of FLASH EPROM to be disabled.

COLOR/MONO (MONO/CLR)

Chooses Monochrome or Color video mode at boot.

PASSWORD CLEAR (ENA/DIS PSWD)

Allows system password to be cleared.

VOLTAGE CONTROL (5.0V/5.27V)

Set at the factory to regulate CPU voltage at 5.0V for 60 MHz Pentium processor or 5.27V for 66 MHz Pentium processor. Improper operation may result if the factory setting is changed.

Appendix C – Connectors

AT STYLE KEYBOARD PORT

Pin	Signal Name
1	Clock
2	Data
3	No Connect
4	Ground
5	Vcc (fused)

PRIMARY POWER

Pin	Name	Function
1	PWRGD	Power Good
2	+5 V	+ 5 volts Vcc
3	+12 V	+ 12 volts
4	-12 V	- 12 volts
5	GND	Ground
6	GND	Ground
7	GND	Ground
8	GND	Ground
9	-5 V	-5 volts
10	+5 V	+ 5 volts Vcc
11	+5 V	+ 5 volts Vcc
12	+5 V	+ 5 volts Vcc

AUXILIARY (3.3V) POWER

Pin	Name	Function
1	GND	Ground
2	GND	Ground
3	GND	Ground
4	+3.3 V	+ 3.3 volts
5	+3.3V	+ 3.3 volts
6	+3.3 V	+ 3.3 volts

SPEAKER CONNECTOR

Pin	Signal Name
1	SPKR_DAT
2	Key
3	No Connect
4	+5V Vcc

RESET CONNECTOR

Pin	Signal Name
1	RESET
2	Ground

KEY LOCK/POWER LED

Pin	Signal Name
1	LED_PWR
2	Key
3	Ground
4	KEY LOCK
5	Ground

HARD DRIVE LED (DISK)

Pin	Signal Name
1	PULL_UP_330
2	HD ACTIVE-
3	Key
4	PULL_UP_330

TURBO LED

Pin	Signal Name
1	PULL_UP_330
2	LED_TURBO-

TURBO SWITCH

Pin	Signal Name
1	TURBO
2	Ground
3	No Connect

12V FAST FAN POWER

Pin	Signal Name
1	Ground
2	+12 V (polyfused)
3	Ground

10V SLOW FAN POWER

Pin	Signal Name
1	Ground
2	+10 V (polyfused)
3	Ground

SERIAL PORTS

Pin	Signal Name
1	DCD
2	DSR
3	Serial In - (SIN)
4	RTS
5	Serial Out - (SOUT)
6	CTS
7	DTR
8	RI
9	GND
10	N.C.

IDE CONNECTOR

Signal Name	Pin	Pin	Signal Name
Reset IDE	1	2	Ground
Host Data 7	3	4	Host Data 8
Host Data 6	5	6	Host Data 9
Host Data 5	7	8	Host Data 10
Host Data 4	9	10	Host Data 11
Host Data 3	11	12	Host Data 12
Host Data 2	13	14	Host Data 13
Host Data 1	15	16	Host Data 14
Host Data 0	17	18	Host Data 15
Ground	19	20	Key
DRQ3*	21	22	Ground
I/O Write-	23	24	Ground
I/O Read-	25	26	Ground
IOCHRDY	27	28	BALE
DACK3-*	29	30	Ground
IRQ14	31	32	IOCS16-
Addr 1	33	34	Ground
Addr 0	35	36	Addr 2
Chip Select 0-	37	38	Chip Select 1-
Activity	39	40	Ground

*no connect on PCI IDE

FLOPPY CONNECTOR

Signal Name	Pin	Pin	Signal Name
Ground	1	2	FDHDIN
Ground	3	4	Reserved
Key	5	6	FDEDIN
Ground	7	8	Index-
Ground	9	10	Motor Enable A-
Ground	11	12	Drive Select B-
Ground	13	14	Drive Select A-
Ground	15	16	Motor Enable B-
Ground	17	18	DIR-
Ground	19	20	STEP-
Ground	21	22	Write Data-
Ground	23	24	Write Gate-
Ground	25	26	Track 00-
Ground	27	28	Write Protect-
Ground	29	30	Read Data-
Ground	31	32	Side 1 Select-
Ground	33	34	Diskette

PARALLEL PORT CONNECTOR

Signal Name	Pin	Pin	Signal Name
STROBE-	1	2	AUTO FEED-
Data Bit 0	3	4	ERROR-
Data Bit 1	5	6	INIT-
Data Bit 2	7	8	SLCT IN-
Data Bit 3	9	10	Ground
Data Bit 4	11	12	Ground
Data Bit 5	13	14	Ground
Data Bit 6	15	16	Ground
Data Bit 7	17	18	Ground
ACJ-	19	20	Ground
BUSY	21	22	Ground
PE (Paper End)	23	24	Ground
SLCT	25	26	N.C.

ISA CONNECTORS

Signal Name	Pin	Pin	Signal Name
GND	B1	A1	IOCHK-
RSTDRV	B2	A2	SD7
Vcc	B3	A3	SD6
IRQ9	B4	A4	SD5
-5V	B5	A5	SD4
DRQ2	B6	A6	SD3
-12V	B7	A7	SD2
0WS-	B8	A8	SD1
+12V	B9	A9	SD0
GND	B10	A10	IOCHRDY
SMEMW-	B11	A11	AEN
SMEMR-	B12	A12	SA19
IOW-	B13	A13	SA18
IOR-	B14	A14	SA17
DACK3-	B15	A15	SA16
DRQ3	B16	A16	SA15
DACK1-	B17	A17	SA14
DRQ1	B18	A18	SA13
REFRESH-	B19	A19	SA12
SYSCLK	B20	A20	SA11
IRQ7	B21	A21	SA10
IRQ6	B22	A22	SA9
IRQ5	B23	A23	SA8
IRQ4	B24	A24	SA7
IRQ3	B25	A25	SA6
DACK2-	B26	A26	SA5
TC	B27	A27	SA4
BALE	B28	A28	SA3
Vcc	B29	A29	SA2
OSC	B30	A30	SA1
GND	B31	A31	SA0
	KEY	KEY	
MEMCS16-	D1	C1	SBHE-
IOCS16-	D2	C2	LA23
IRQ10	D3	C3	LA22
IRQ11	D4	C4	LA21
IRQ12	D5	C5	LA20
IRQ15	D6	C6	LA19
IRQ14	D7	C7	LA18
DACK0-	D8	C8	LA17
DRQ0	D9	C9	MEMR-
DACK5-	D10	C10	MEMW-
DRQ5	D11	C11	SD8
DACK6-	D12	C12	SD9
DRQ6	D13	C13	SD10
DACK7-	D14	C14	SD11
DRQ7	D15	C15	SD12
Vcc	D16	C16	SD13
Master-	D17	C17	SD14
GND	D18	C18	SD15

PCI CONNECTORS (J10B1, J10C1, J10C2)

Signal Name	Pin	Pin	Signal Name
GND	A1	B1	-12V
+12V	A2	B2	No Connect
No Connect	A3	B3	GND
No Connect	A4	B4	No Connect
Vcc	A5	B5	Vcc
PCIINT3-	A6	B6	Vcc
PCIINT1-	A7	B7	PCIINT2-
Vcc	A8	B8	PCIINT4-
Reserved	A9	B9	No Connect
Vcc	A10	B10	Reserved
Reserved	A11	B11	No Connect
GND	A12	B12	GND
GND	A13	B13	GND
Reserved	A14	B14	Reserved
SPCIRST-	A15	B15	GND
Vcc	A16	B16	PCLKE
AGNT-	A17	B17	GND
GND	A18	B18	REQA-
Reserved	A19	B19	Vcc
AD30	A20	B20	AD31
3.3V	A21	B21	AD29
AD28	A22	B22	GND
AD26	A23	B23	AD27
GND	A24	B24	AD25
AD24	A25	B25	3.3V
AD22 (IDSEL)	A26	B26	CBE3-
3.3V	A27	B27	AD23
AD22	A28	B28	GND
AD20	A29	B29	AD21
GND	A30	B30	AD19
AD18	A31	B31	3.3V

Signal Name	Pin	Pin	Signal Name
AD16	A32	B32	AD17
3.3V	A33	B33	CBE2-
FRAME-	A34	B34	GND
GND	A35	B35	IRDY-
TRDY-	A36	B36	3.3V
GND	A37	B37	DEVSEL-
STOP-	A38	B38	GND
3.3V	A39	B39	PLOCK-
SDONE	A40	B40	PERR-
SBO-	A41	B41	3.3V
GND	A42	B42	SERR-
PAR	A43	B43	3.3V
AD15	A44	B44	CBE1-
3.3V	A45	B45	AD14
AD13	A46	B46	GND
AD11	A47	B47	AD12
GND	A48	B48	AD10
AD9	A49	B49	GND
KEY	A50	B50	KEY
KEY	A51	B51	KEY
CBEO-	A52	B52	AD8
3.3V	A53	B53	AD7
AD6	A54	B54	3.3V
AD4	A55	B55	AD5
GND	A56	B56	AD3
AD2	A57	B57	GND
AD0	A58	B58	AD1
Vcc	A59	B59	Vcc
SREQ64-	A60	B60	SACK64-
Vcc	A61	B61	Vcc
Vcc	A62	B62	Vcc

Appendix D – Memory Map

Address Range (Deci-)	Address Range (hex)	Size	Description
1024K-131072K	100000-8000000	130048K	Extended Memory
960K-1023K	F0000-FFFFF	64K	AMI System BIOS
952K-959K	EE000-EFFFF	8K	FLASH Boot Block (Available as HIMEM)
948K-951K	ED000-EDFFF	4K	Logo reserved
928K-947K	E8000-ECFFF	20K	BIOS RESERVED
640K-927K	A0000-E7FFF	288K	Available HI DOS Memory (open to the ISA & PCI bus)
639K	9FC00-9FFFF	1K	Extended BIOS Data (moveable by QEMM, 386MAX)
512K-638K	80000-9FBFF	127K	Extended conventional
0K-511K	00000-7FFFF	512K	Conventional

Table D-1. Premiere/PCI Baby-AT motherboard Memory Map

Appendix E – I/O Map

Address (hex)	Size(Dec)	Description	Address (hex)	Size(Dec)	Description
0000 - 000F	16 bytes	SIO - DMA 1	02E8 - 02EF	8 bytes	Serial Port 4
0020 - 0021	2 bytes	SIO - Interrupt Controller 1	02F8 - 02FF	8 bytes	On-Board Serial Port 2
0040 - 0043	4 bytes	SIO - Timer 1	0376	1 byte	Secondary IDE Chan Cmd Port
0048 - 004B	4 bytes	SIO - Timer 2	0377	1 byte	Secondary IDE Chan Stat Port
0060	1 byte	Keyboard Controller Data Byte	0378 - 037F	8 bytes	Parallel Port 1
0061	1 byte	SIO - NMI, speaker control	03BC - 03BF	4 bytes	Parallel Port x
0064	1 byte	Kbd Controller, CMD/STAT Byte	03E8 - 03EF	8 bytes	Serial Port 3
0070, bit 7	1 bit	SIO - Enable NMI	03F0 - 03F5	6 bytes	Floppy Channel 1
0070, bits 6:0	7 bits	SIO - Real Time Clock, Address	03F6	1 bytes	Primary IDE Channel Cmdnd Port
0071	1 byte	SIO - Real Time Clock, Data	03F7 (Write)	1 byte	Floppy Channel 1 Command
0073	1 byte	Reserved - Brd. Config.	03F7, bit 7	1 bit	Floppy Disk Change Channel 1
0075	1 byte	Reserved - Brd. Config.,RD only	03F7, bits 6:0	7 bits	Primary IDE Channel Status Port
0078	1 byte	SIO - BIOS Timer	03F8 - 03FF	8 bytes	On-Board Serial Port 1
0080 - 008F	16 bytes	SIO - DMA Page Register	0678 - 067A	3 bytes	Parallel Port 2 ECP Registers**
00A0 - 00A1	2 bytes	SIO - Interrupt Controller 2	0778 - 077A	3 bytes	Parallel Port 1 ECP Registers**
00C0 - 00DE	31 bytes	SIO - DMA 2	0CF8	1 byte	PCI Configuration Space Enable
00F0	1 bytes	Reset Numeric Error	0CF9	1 byte	Deturbo Mode Enable
0170 - 0177	8 bytes	Secondary IDE Channel	C000 - C0FF	256 byte	82434LX Config. Registers *
01F0 - 01F7	8 bytes	Primary IDE Channel	C200 - C2FF	256 byte	82378IB Config. Registers *
0278 - 027F	8 bytes	Parallel Port 2			

Table E-1. Premiere/PCI Baby-AT I/O Address Map
 * Only accessible after PCI configuration space is enabled.
 ** Only used when ECP mode is enabled

Appendix F – Interrupts & DMA Channels

<i>IRQ</i>	<i>System Resource</i>
NMI	Parity Error
0	Reserved, Interval Timer
1	Reserved, Keyboard buffer full
2	Reserved, Cascade interrupt from slave PIC
3	Serial Port 2
4	Serial Port 1
5	Parallel Port 2
6	Floppy
7	Parallel Port 1
8	Real Time Clock
9	User available
10	User available
11	User available
12	PS/2 Mouse Port, User available on AT style bds
13	Reserved, Math coprocessor
14	Primary IDE if enabled, else available to user
15	Secondary IDE if enabled, else available to user

Table F-1. Premiere/PCI Baby-AT Interrupts

<i>DMA</i>	<i>Data Width</i>	<i>System Resource</i>
0	8- or 16-bits	Open
1	8- or 16-bits	Open - Normally used for LAN
2	8- or 16-bits	Floppy
3	8- or 16-bits	Parallel Port
4		Reserved - Cascade channel
5	16-bits	Open
6	16-bits	Open
7	16-bits	IDE

Table F-2. Premiere/PCI Baby-AT DMA Map

Appendix G – AMIBIOS Setup

The BIOS Setup utility has four major menus: Main, Advanced, Security and Exit. Each of these menus occupies the left and center sections of the screen. Selecting certain fields within the menus will drop the user into sub-menus. On the right side of the display is a Command Screen for interacting with the Setup utility. In each of the following sections, the field which is being displayed is in **bold** type. If there are user selectable options for that field they are displayed in *italic* type. Explanations and comments about the fields and options are contained within boxes.

COMMAND SCREEN NAVIGATION

The right side of the Setup screen contains a list of commands which are available to the user and are displayed at all times, for each menu and sub-menu.

F1 Help

Help is provided for a subset of the fields. It can not be invoked when parameter options are being displayed.

ESC Back

The ESC key provides a mechanism for backing out of any field. When the ESC key is entered from the top level of any field, the field options cease to be displayed. When the ESC key is entered from the top level of any sub-menu, the parent menu is re-entered. When the ESC key is entered from the top level of any major menu the following screen is displayed:

Exit Discarding Changes
Press Enter to Continue
Press ESC to Abort

At this point pressing the Enter key will cause the user to leave the Setup Utility without saving any changes they might have made. Pressing the ESC key will bring them back to the top level of the current menu.

Enter Select

The Enter key is used to activate sub-menus, change parameters and select parameter options.

↑ Previous Item

The up arrow is used to move to the menu item above the current item. It does not wrap around.

↓ Next Item

The down arrow is used to move to the menu item below the current item. It does not wrap around.

↔ Select Menu

The left and right arrow keys are used to move between the 4 major menus. They do not wrap around.

F5 Setup Defaults

The F5 key is used to set all Setup Parameters to default values. When this key is pressed the following message appears:

Load Setup Defaults?
Press Enter to Continue
Press ESC to Abort

If the Enter key is selected then all Setup Parameters will be set to their default values. If the ESC key is selected, then the user is returned to where they were before F5 was pressed without effecting any change.

F6 Previous Values

The Previous Values key is used to set all parameters to their previous values. When pressed, the following message appears:

Discard Changes?
Press Enter to Continue
Press ESC to Abort

If the Enter key is selected then all Setup Parameters will be return to the values selected when Setup was entered. If the ESC key is selected, then the user is returned to where they were before F6 was pressed without effecting any change.

F10 Save & Exit

The Save & Exit key is used to exit the Setup Utility saving the current state of all parameters When this key is pressed the following message appears:

Exit Saving Changes?
Press Enter to Continue
Press ESC to Abort

If the Enter key is selected then the Setup Utility will be exited with all parameters set to their current values. If the ESC key is selected, then the user is returned to where they were before F10 was pressed without effecting any change.

MAIN MENU NAVIGATION

Each menu contains a number of parameters. Most parameters can be changed by the user, although some are only

informative. Parameters which can be changed by the user are displayed in black, informative only parameters are displayed in blue. Depending on the security option chosen and in effect (via password), a parameter can be either changeable or non-changeable. A parameter which is non-changeable due to insufficient security privilege or other reasons will be grayed out. Parameters which have no effect based on the value other parameters are not displayed.

MAIN MENU LEVEL

System Date
Month-Day-Year

The **System Date** field specifies the current date .

System Time
Hour:Minute:Second

The **System Time** field specifies the current time.

Floppy A:
Floppy B:
Disabled
360 Kb, 5.25"
1.2 Mb, 5.25"
720Kb, 3.5"
1.44 Mb, 3.5"
2.88 Mb, 3.5"

The **Floppy A: Type** and **Floppy B: Type** fields specify the physical size and maximum supported media size of the floppy drives attached to the floppy interface.

Hard Disk C:
Hard Disk D:
Identification string returned from drive
Not Installed

The **Hard Disk C:** through **Hard Disk F:** fields report the presence of, and identification string reported by, up to 4 physical IDE drives. When the cursor is placed on one of these fields and it is selected by hitting the *Enter* Key, the **Hard Disk Sub-Menu** appears (see below) allowing parameters which affect the drives to be set.

Disk drive assignments
Drive letters will be assigned to physical drives as follows:

P rimary IDE Interface Only	
Master	C:
Slave	D:

Secondary IDE Interface Only	
Master	C:
Slave	D:

Primary & Secondary Interface, Two Drives Used	
Primary Master	C:
Secondary Master	D:

Primary & Secondary Interfaces, Three Drives Used	
Primary Master	C:
Primary slave	D:
Secondary Master	E:

Primary Master	C:
Secondary Master	D:
Secondary slave	E:

Primary & Secondary Interfaces, Four Drives Used	
Primary Master	C:
Primary Slave	D:
Secondary Master	E:
Secondary Slave	F:

When drives have multiple partitions on them, partitions beyond the primary partition will be assigned in ascending order, based on available drive letters and other installed drives. Partitions are assigned to primary partitions first (across multiple drives), and then to secondary partitions. This means that when there are multiple drives with multiple partitions, the logical drive numbering scheme may result in discontinuous logical partitions on the same physical drive.

For instance, if there is a "Drive 1" with two partitions which is a Master on the Primary IDE interface, a "Drive 2" with three partitions which is a Slave on the Primary interface, and a "Drive 3" with two partitions which is a master on the Secondary interface the drive letters will be assigned as follows:

Drive 1	Primary Partition	C:
	Secondary Partition	F:
Drive 2	Primary Partition	D:
	Secondary Partition	G:
	Tertiary Partition	H:
Drive 3	Primary Partition	E:
	Secondary Partition	I:

Hard Disk Sub-Menu

Hard Disk Type

Auto Configured -- default

User Definable

Number of Cylinders

Number of Heads

Number of Sectors

If Hard Disk Type = Auto Configured

Then parameters reported by drive

If Hard Disk Type = User Definable

Then parameters entered by user

The **Number of Cylinders**, **Number of Heads**, and **Number of Sectors** fields display what is reported by the drive if **Hard Disk Type** is set to *Auto Configured*. If **Hard Disk Type** is set to *User Definable* then these fields are entered by the user. **Hard Disk Type** should be set to *Auto Configured* unless the drive was formatted on another system with parameters different than those reported by the drive.

Maximum Capacity

Value calculated from Cylinder, Head, and Sector info above

Initialization Timeout

Disabled

5 Seconds

10 Seconds -- default

31 Seconds

Initialization Timeout selects the number of seconds the BIOS will wait to determine if an IDE drive is present, after initiating a transaction with the drive. If a drive is present and responds to the BIOS before the Initialization Timeout period, then the BIOS will proceed, i.e. there is no boot-time penalty for a large value when a drive is present. If a drive is not present, then the BIOS will wait the Initialization Timeout period before proceeding. If a drive is present, but does not respond to the BIOS within the Initialization Timeout range, then the BIOS will not see the drive and it will not be accessible. This value should be set to *Disabled* for any IDE drives not installed. This parameter works in conjunction with the **Hard Disk Pre-Delay** parameter contained in the **Boot Options** sub-menu of the Main menu.

IDE Translation Mode

Standard CHS -- default

Logical Block

Extended CHS

Auto Detected

The **IDE Translation Mode** parameter controls the way in which the BIOS interacts with the drive in terms of drive geometry. Proper choice is dependent upon the drive's size, capabilities, and the operating system (OS) used.

Standard CHS is the translation mode that has been in use for years. Its use limits IDE capacity to a maximum of 528 Megabytes regardless of the size of the drive used.

Logical Block mode overcomes the 528 MB maximum size limitation imposed by *Standard CHS* mode. It should be used only when the drive supports LBA (Logical Block Addressing), and the OS supports LBA, or uses the BIOS to access the disk.

Extended CHS mode also overcomes the 528 MB maximum size limitation imposed by *Standard CHS* mode. It can be used with drives which are larger than 528 MB, but do not support LBA mode.

Auto Detected allows the BIOS to examine the drive and determine the optimal mode. The first choice is to utilize *Logical Block* mode if it is supported by the drive. The second choice is to utilize *Extended CHS* mode if the drive topology allows. If neither of the above two methods are possible, then *Standard CHS* mode is used. **Important NOTE: When set to Auto Detected the BIOS will detect what the drive is capable of, not the translation mechanism which was used to format the drive. If a drive is run in a mode other than the mode in which it was partitioned and formatted, unpredictable results may occur, including data loss.**

Different operating systems have different abilities regarding IDE Translation Modes:

UNIX operating systems (as currently implemented) do not support either LBA or ECHS and must utilize the Standard CHS method. UNIX can support drives larger than 528 MB, but does so in its own way.

OS/2 2.1 can support LBA, ECHS or Standard CHS methods. Note that LBA support may require a switch setting on an OS/2 driver in order to operate in that mode. (*)

OS/2 2.0 & Novell Netware can support either ECHS or Standard CHS methods, but not LBA.

DOS & Windows can support LBA, ECHS or Standard CHS methods. If the "Fast 32-bit IDE" option of Windows is utilized, make sure to

use the Standard CHS setting only, unless a version of WDCDRV.386 is being used which supports these advanced geometrys. You will get better performance NOT using "Fast 32-bit IDE" if using a drive which employs Mode 3 PIO on the PCI interface, unless using a version of WDCDRV.386 which supports these advanced modes.

Multiple Sector Setting
Disabled
4 Sectors/Block
8 Sectors/Block
Auto Detected -- default

The **Multiple Sector Setting** field controls the number of sectors which are transferred by an IDE drive per interrupt generated. If set to *Disabled*, then an interrupt will be generated for each sector transferred, even if the OS issues a multi-sector transfer. If set to *4 Sectors/Block* or *8 Sectors/Block* then 4 or 8 sectors will be transferred per interrupt (for a request that is as large as, or larger than 4 or 8 sectors). If *Auto Detected* is chosen, then x sectors will be transferred per interrupt, where x is the maximum value supported by the drive. If a drive does not support multiple sectors/block then the BIOS will ignore this setting. If the drive does not support the specific number (4 or 8) of sectors chosen, then the BIOS will default to the largest number of sectors smaller than the chosen value supported by the drive.

Fast Programmed I/O Modes
Disabled
Auto Detected -- default

The **Fast Programmed I/O Modes** field controls the speed in which Programmed I/O (PIO) transfers occur on the PCI IDE interface. If set to *Disabled*, transfers occur at an un-optimized (Mode 0) speed. If set to *Auto Detected*, transfers occur at the rate which the drive reports as its maximum (up to and including the maximum mode 3 timing). This field should only be set to *Disabled* if a drive is being used which incorrectly reports an ability to function with advanced timings.

MAIN MENU LEVEL

Language
English (US)
..

The **Language** field controls the language of the text strings used in Setup and the BIOS. Any installed language will appear as an option in its own language (for example, German will appear as Deutsch). Only installed languages will appear as options.

Boot Options

When the cursor is placed the **Boot Options** field and it is selected by hitting the *Enter* Key, the **Boot Options** Sub-Menu appears allowing parameters which affect the boot process to be set.

Boot Options Sub-Menu

Boot Sequence
C: First, Then A:
A: First, Then C: -- default
C: Only
A: Only

The field controls the order in which the BIOS attempts to boot from the hard and floppy drives.

System Cache
Disabled
Enabled -- default

The **System Cache** field controls both the primary and secondary caches. Setting **System Cache** *Disabled* will hurt performance, but might be required when running software which utilizes software timing loops and needs to be slowed down to execute properly.

Boot Speed
Turbo -- default
De-turbo

The **Boot Speed** field controls the system CPU cycles. De-turbo mode slows the CPU by disabling system cache and adding increased refresh cycles. It does not reduce CPU speed to 4.77Mhz or 8Mhz AT class machines.

Num Lock
Off -- default
On

The **Num Lock** field controls whether the keyboard Num Lock function is turned on or off when the system is booted.

Setup Prompt

Disabled
Enabled -- default

The **Setup Prompt** field controls whether the "Press <F1> Key To Enter Setup" message is displayed during POST (Power On Self Test). It does not control access, just the message.

Hard Disk Pre-Delay

Disabled
1 Second
2 Seconds
3 Seconds -- default
4 Seconds
5 Seconds
6 Seconds
7 Seconds

The **Hard Disk Pre-Delay** provides a mechanism which delays the BIOS's attempt to initialize the first IDE drive in the system. It is necessary because certain drives take longer than others to "spin up" and might hang if they are accessed too soon after being powered up or reset. The delay is only honored for the first drive accessed. This parameter works in conjunction with the **Initialization Timeout** parameter contained in the Hard Disk Sub-menu of the **Main** menu. The two are added together.

It should be noted that this new addition to the BIOS Setup is the result of our speeding up the POST process.

Typematic Rate Programming

Default -- default
Override

The parameter controls whether default or user configurable values are used for **Typematic Rate Delay** and **Typematic Rate** (see below). If **Default** is chosen then **Typematic Rate Delay** is set to 500 msec and **Typematic Rate** is set to 15. If **Override** is chosen the following two screens appear allowing the user to customize these values.

Typematic Rate Delay

250 msec -- default
500 msec
750 msec
1000 msec

The **Typematic Rate Delay** field controls how long it takes for the keyboard auto-repeat function to start when a key is held down.

Typematic Rate

6 char/sec -- default
8 char/sec
10 char/sec
12 char/sec
15 char/sec
20 char/sec
24 char/sec
30 char/sec

The **Typematic Rate Delay** field controls the speed characters repeat when you hold down a keyboard key. The higher the number, the faster the repeat.

MAIN MENU LEVEL

Video Mode

The **Video Mode** field is informative only.

Mouse

The **Mouse** field is informative only. If the system supports a PS/2 style mouse, and the mouse is installed, this field will be displayed. If the system does not support a PS/2 style mouse, or if it does and the mouse is not installed, this field will not be displayed.

Base Memory

This **Base Memory** field is informative only. There is another **Base Memory** field which can be changed in the **Advanced Chipset Configuration** Sub-Menu of the **Advanced** menu.

Extended Memory

The **Extended Memory** field is informative only. Amount of system memory above 1 Megabyte

ADVANCED MENU

Processor Type
Processor Speed
Cache Size

The **Processor Type**, **Processor Speed**, and **Cache Size** fields are informative only and can not be changed by the user. **Cache Size** refers to the L2 cache only.

Peripheral Configuration
Advanced Chipset Configuration
Power Management Configuration
Plug and Play Configuration

The **Peripheral Configuration**, **Advanced Chipset Configuration**, **Power Management**, and **Plug and Play Configuration** fields are used to enter sub-menus where these areas are configured. Press Enter to access.

PERIPHERAL CONFIGURATION SUB-MENU

Configuration Mode
Auto -- default
Manual

The **Configuration Mode** fields controls whether on board resources are manually or automatically set up. When set to *Auto*, on board system peripherals (IDE drives, Floppy Drive, Serial Ports, Parallel Port) are automatically configured during power up. When set to *Manual*, system peripherals must be explicitly configured. The following 6 fields (**PCI IDE Interface** to **Parallel Port Address**) are only user accessible when **Configuration Mode** is set to *Manual*.

PCI IDE Interface
Enabled -- default
Disabled
Floppy Interface
Enabled -- default
Disabled

PCI IDE Interface and **Floppy Interface** allow these drive interfaces to be individually enabled or disabled.

Serial Port 1 Address
Disabled
COM1, 3F8h -- default
COM2, 2F8h
COM3, 3E8h
COM4, 2E8h
Serial Port 2 Address
Disabled
COM1, 3F8h
COM2, 2F8h -- default
COM3, 3E8h
COM4, 2E8h

The **Serial Port 1 Address**, **Serial Port 2 Address** fields allow the user to select the I/O ports used by these interfaces. If a COM port is chosen for one of the Serial Port Addresses, it will not appear in the option list for the other Serial Port Address, i.e. if one of the Serial Port Addresses is set to *Disabled*, then there will be four choices for the other serial port address. Otherwise there will be three choices.

Parallel Port Address
Disabled
LPT3, 3BCh
LPT1, 378h -- default
LPT2, 278h

The **Parallel Port Address** fields allow the user to select the I/O ports used by these interfaces.

Parallel Port Mode
Compatible -- default
Extended
EPP
ECP

When set to *Compatible*, the parallel port will be set up in a mode compatible with the original AT. When set to *Extended* the parallel port will be set up in the most advanced mode allowed by the chipset (ex. EPP, ECP). EPP and ECP modes can also be set manually.

Comentario [dc3]: Page: 25
Parallel modes supported on Phase II, plato were Compatible, EPP,ECP, both ecp and epp. This is changing on BIOS 11 to be compatible, Extended, EPP, ECP. This is most likely where all systems will end up.

Serial Port 1 IRQ
Interrupt Used
 Serial Port 2 IRQ
Interrupt Used
 Parallel Port IRQ
Interrupt Used

The **Serial Port 1 IRQ**, **Serial Port 2 IRQ** and **Parallel Port IRQ** fields display the interrupts used by the Serial and Parallel Ports. These values may not be changed by the user. If an interface is disabled via the **Serial Port 1 Address**, **Serial Port 2 Address**, or **Parallel Port Address** fields, then the associated interrupt is not displayed, and is available for use by add in cards.

ADVANCED CHIPSET CONFIGURATION SUB-MENU

Base Memory Size
 512KB
 640 KB -- default

The **Base Memory Size** field controls the mapping of addresses between 512K and 640K (80000h-9FFFFh). If *512KB* is chosen then accesses between 512K and 640K are directed to the ISA bus. When *640 KB* is selected accesses between 512K and 640K are directed to system DRAM. Unless using an ISA card which requires access to this particular address range this field should be set to *640 KB*.

ISA Bus Speed
Compatible -- default
Enhanced

The **ISA Bus Speed** field controls the speed of the ISA Bus clock. If set to *Compatible* the speed will fall within the limits defined by the IBM AT Technical Reference (6-8.33 Mhz). If set to *Enhanced* the speed will be greater than the maximum defined by the IBM AT Technical Reference manual. Modern ISA cards can operate with the enhanced speeds, however some older cards can experience difficulties. ISA performance will be enhanced when **ISA Bus Speed** is set to enhanced. The actual value of the Bus Clock when set to *Compatible* or *Enhanced* is dependent upon the external frequency of the CPU:

External Frequency	Compatible	Enhanced
60 Mhz	7.5 Mhz	10 Mhz
66 Mhz	8.25 Mhz	11 Mhz

Byte Merging
Enabled
Disabled -- default

Byte Merging is a feature which increases performance for older applications which write to video memory in bytes instead of words. However, this feature is not supported on all PCI video cards. For best performance this field should be *enabled* unless a PCI graphics card which does not support this feature is used. If this field is *enabled* and used with a card which lacks support video corruption will be seen in some video modes.

ISA LFB Size
Disabled -- default
 1 MB
 3 MB
 7 MB

The **ISA Video Linear Frame Buffer Size** provides a mechanism for creating a hole in the system memory map. Accesses made to addresses within this hole will be directed to the ISA bus instead of main memory. This should be set to *Disabled* unless you are using an ISA card which has memory greater than 64K which needs to be accessed by the CPU, and you are not using the Plug and Play run-time utilities (Configuration Manager & ISA Configuration Utility).

ISA LFB Base Address
 Dependent upon ISA LFB Size

If	ISA LFB Size	Then	ISA LFB Base Address
	<i>Disabled</i>		N.A.
	1 MB		15 MB
	3 MB		13 MB
	7 MB		9 MB

The **ISA Video LFB Base Address** field displays the starting address of the ISA memory hole if a value other than *Disabled* is chosen for the **ISA Video LFB Size** parameter. If **ISA Video LFB Size** is set to *disabled*, then this field does not appear. This field is informative only, i.e. it cannot be changed by the user.

Video Palette Snoop
Disabled
Enabled -- default

The **Video Palette Snoop** field controls the ability of a PCI graphics cards to "snoop" write cycles to an ISA video card's color palette registers. This should normally be set to *Enabled*. It should only be set to *Disabled* if:

- AND That ISA card connects to a PCI graphics card via the VESA connector
- AND That ISA card uses the RAMDAC on the PCI card
- AND The Palette Snooping feature (also called RAMDAC shadowing) is broken on the PCI card.

Latency Timer (PCI Clocks)
 Number between 0 and 256
 66 -- default

The **Latency Timer (PCI Clocks)** field controls the length of time an agent on the PCI bus can hold the bus when another agent has requested the bus. Its default value is 66. In general this should not be changed. If there are latency sensitive cards in the system (such as audio cards and/or network cards with small buffers) this can be set to a lower value to reduce latency. If there are no latency sensitive cards in the system, but I/O intensive applications are being run, this can be increased to slightly improve performance.

POWER MANAGEMENT CONFIGURATION SUB-MENU

Advanced Power Management
 Enabled
 Disabled -- default

The **Advanced Power Management** field enables or disables Advanced Power Management (APM) support in the BIOS. If set to *enabled* the BIOS will work with APM aware Operating Systems to manage the power consumed by the CPU, IDE drives, and graphics cards. If set to *Disabled* then none of the other fields in the Power Management Configuration Sub-Menu are displayed.

IDE Drive Power Down
 Enabled
 Disabled -- default

The IDE Drive Power Down field controls whether or not a spin down command will be issued to the IDE drives when the system goes into low power mode.

VESA Video Power Down
 Disabled -- default
 Standby
 Suspend
 Sleep

The **VESA Video Power Down** field controls the VESA power management command issued to the graphics card when the system goes into low power mode. The proper setting is dependent upon the VESA mode(s) supported by your graphics card.

Inactivity Timer (Minutes)
 0 to 255
 0 -- default

Inactivity Timer (Minutes) controls the number of minutes that the system will detect no user activity before going into low power mode.

Hot Key
 User definable

The **Hot Key** field is used to define a key which when entered will cause the APM BIOS to ask an APM (Advanced Power Management) aware Operating Systems to go into immediate power managed mode. There will be some delay, typically about a minute before the system actually goes into power managed mode, however the speaker will issue 2 descending tones.

If there is a User Password in effect then upon going into power managed mode the Num Lock, Caps Lock, and Scroll Lock LEDs on the keyboard will flash on and off in sequence, indicating to the user that the system is in Secure Mode. In this case the correct password will have to be entered before the user regains control of the system. This password will not be echoed to the screen, whether the screen is active or inactive at the time the password is entered (see **Set User Password** field in Security Menu). The following table describes how the Power Down hot key interacts with the Security Hot Key:

	Power-Down Hot Key Entered	Security Hot Key Entered
Power-Down Hot Key Only Enabled	<ol style="list-style-type: none"> 1. System powers down \approx1 minute (can include screen blanking if enabled) 2. Powers up when any key/mouse activity is detected 	N.A.
Security Hot Key Only Enabled	N.A.	<ol style="list-style-type: none"> 1. System Secure Immediately 2. LEDs sequence 3. Input accepted when password typed
Both Hot Keys Enabled	<ol style="list-style-type: none"> 1. System Secure Immediately 2. System powers down \approx1 minute (can include screen blanking if enabled) 3. LEDs sequence 4. Input accepted when password typed 5. Powers up when any key/mouse activity is detected 	<ol style="list-style-type: none"> 1. System Secure Immediately 2. System powers down \approx1 minute (can include screen blanking if enabled) 3. LEDs sequence 4. Input accepted when password typed 5. Powers up when any key/mouse activity is detected

PLUG AND PLAY CONFIGURATION SUB-MENU

Configuration Mode
Use Setup Utility -- default
Use ICU

The **Configuration Mode** field is used to choose the method in which information about legacy ISA cards (ISA cards which do not have Plug and Play capabilities) is conveyed to the BIOS to allow the BIOS to set up PCI cards and ISA Plug and Play cards without conflicting with the legacy ISA cards.

If *Use ICU* is chosen, then the BIOS will depend upon information provided by run-time Plug and Play software (Configuration Manager and ISA Configuration Utility) to ensure that there are no conflicts with legacy ISA cards. Only choose this method if your system is configured with these utilities and they are used. When *Use ICU* is chosen no other fields are displayed in this Sub-Menu.

If *Use Setup Utility* is chosen, then the BIOS will depend upon information provided by the user in the fields below to prevent conflicts between Plug and Play cards and legacy ISA cards. If the *Use Setup Utility* is chosen then the user should not install and use run-time Plug and Play software (Configuration Manager and ICU).

ISA Shared Memory Size
Disabled -- default
16 KB
32 KB
48 KB
64 KB

The **ISA Shared Memory Size** field is used to set a block of system memory which will not be shadowed (shadowing is a technique which copies a block of memory from an add in card's ROM to the same address in system memory to allow faster access to the code and achieve higher performance). By default all upper memory is shadowed unless a block is un-shadowed using this and the **ISA Shared Memory Base Address** fields.

This field should be set to *Disabled* unless an ISA card is used which communicates with the CPU through a block of shared memory located in the upper memory area. If set to a value other than *Disabled* the **ISA Shared Memory Base Address** field will appear below. Note that if a value of *64 KB* is chosen, then the **ISA Shared Memory Base Address** field can only be set to *D0000h* or below.

ISA Shared Memory Base Address
C0000h
C4000h
C8000h
CC000h
D0000h
D4000h
D8000h
DC000h

The **ISA Shared Memory Base Address** field works in conjunction with the **ISA Shared Memory Size**. See above.

IRQ 3*
IRQ 4*
IRQ 5
IRQ 7*
IRQ 9
IRQ 10
IRQ 11
IRQ 15*

Available
Used By ISA Card

* These options will not be visible if consumed by on-board resources (IRQ3 Serial Port 1, IRQ4 Serial Port 2, IRQ7 Parallel Port, IRQ 15, both IDE interfaces used).

The **IRQ 3 - IRQ 15** fields are used to indicate whether individual interrupts are used by ISA legacy cards. If not used, then they should be set to *Available*. If used they should be set to *Used By ISA Card*. **Note: All but one can be set to *Used By ISA Card*. One must remain available for PCI cards which use interrupts to function.**

SECURITY MENU

There are two types of passwords available, **User Password** and **Administrative Password**. The User password can be used to control access to the Setup Utility, the keyboard upon initial boot, and the keyboard when used in conjunction with the Security Hot Key. The **Administrative Password** is used to control access to the Setup Utility. The following table describes the interaction between these passwords:

Password In Effect	Enter Setup with User Password	Enter Setup with Admin. Password	Boot
User Password Only	Can change all fields	N.A.	User Password Required
Administrative Password Only	N.A.	Can change all fields	No Password Required
Both	Can change limited number of fields	Can change all fields	User or Administrative Password Required

If the **Administrative Password** is in effect and Setup is entered with the **User Password** only the following fields may be changed: **System Date**, **System Time**, **User Password**, and **Security Hot Key**.

User Password is
Disabled -- default
Enabled
 Administrative Password is
Disabled -- default
Enabled

The **User Password is** and **Administrative Password is** fields indicate whether the User and Administrative passwords have been set. If neither the **User Password is** or the **Administrative Password is** fields are set to *Enabled* neither the **Unattended Start** or **Security Hot Key (CTRL-ALT-)** fields will be displayed.

Set User Password

When the **Set User Password** field is chosen the user is presented with one of two sub-menus. If there is currently no User Password in effect the following menu appears:

Enter New Password _____
Confirm New Password _____
Press Enter or TAB to Accept
Press ESC to Abort

If there is already a User Password in effect, the following menu appears. To disable the password, use a carriage return as the new password.

Enter Current Password _____
Enter New Password _____
Confirm New Password _____
Press Enter or TAB to Accept
Press ESC to Abort

Set Administrative Password

When the **Set Administrative Password** field is chosen the user is presented with one of two sub-menus. If there is currently no Administrative Password in effect the following menu appears:

Enter New Password _____
Confirm New Password _____
Press Enter or TAB to Accept
Press ESC to Abort

If there is already an Administrative Password in effect, the following menu appears. To disable the password, use a carriage return as the new password.

Enter Current Password _____
Enter New Password _____
Confirm New Password _____
Press Enter or TAB to Accept
Press ESC to Abort

Unattended Start
Disabled -- default
Enabled

The **Unattended Start** field controls the point at which the User Password is required. If set to *Disabled* the User Password is required before the system boots, either from disk or the network. The user will be prompted for the password with the text string "Enter Password (1):"

If set to *Enabled* the system will go through automatic boot activity (for instance running CONFIG.SYS and AUTOEXEC.BAT when booting DOS from disk), however the keyboard will be locked and the User Password must be entered to unlock it. The BIOS does not provide any prompt string so it is suggested that the last thing that the automatic login sequence does is prompt the user for the password.

The **Unattended Start** field can only be set if a User Password is in effect.

Security Hot Key (CTRL-ALT-)
Alpha-Numeric Key

The **Security Hot Key (CTRL-ALT-)** field can be used to define a key which when entered in conjunction with the CTRL and ALT keys puts the system into secure mode (locks the keyboard). When this Hot Key combination is entered the Num Lock, Caps Lock, and Scroll Lock LEDs on the keyboard will flash on and off in sequence, indicating to the user that the system is in secure mode (as opposed to being hung).

EXIT MENU

Exit Saving Changes

The Exit Saving Changes field is used to exit the Setup Utility saving the current state of all parameters. When the Enter key is entered the following sub-menu is displayed:

Exit Saving Changes?
Press Enter to Continue
Press ESC to Abort

If the Enter key is selected then the Setup Utility will be exited with all parameters set to their current values. If the ESC key is selected, then the user is returned to the Exit menu without effecting any change.

Exit Discarding Changes

The **Exit Discarding Changes** field is used to exit the Setup Utility discarding any changes made to Setup parameters. When the Enter key is entered the following sub-menu is displayed:

Exit Discarding Changes?
Press Enter to Continue
Press ESC to Abort

If the Enter key is selected then the Setup Utility will be exited with changes to Setup parameters lost. If the ESC key is selected, then the user is returned to the Exit menu without effecting any change.

Load Setup Defaults

The **Load Setup Defaults** field is used to load default values into all Setup parameters, except for the passwords. When the Enter key is entered the following sub-menu is displayed:

Load Setup Defaults?
Press Enter to Continue
Press ESC to Abort

If the Enter key is selected then defaults are loaded into all Setup parameters, except for the passwords. If the ESC key is selected, then the user is returned to the Exit menu without effecting any changes.

Discard Changes

The **Discard Changes** field is used undo any changes made to Setup parameters during this Setup session. When the Enter key is entered the following sub-menu is displayed:

Discard Changes?
Press Enter to Continue
Press ESC to Abort

If the Enter key is selected then any changes made to Setup parameters are discarded. If the ESC key is selected, then the user is returned to the Exit menu without effecting any changes.

Appendix H – AMIBIOS Error messages and Beep Codes

Errors can occur during POST (Power On Self Test) which is performed every time the system is powered on. Fatal errors, which prevent the system to continue the boot process, are communicated through a series of audible beeps. Other errors are displayed in the following format:

ERROR Message Line 1

ERROR Message Line 2

For most displayed error messages, there is only one message. If a second message appears, it is "RUN SETUP". If this message occurs, press <F1> to run AMIBIOS Setup.

BEEP CODES

<i>Beeps</i>	<i>Error Message</i>	<i>Description</i>
1	Refresh Failure	The memory refresh circuitry on the baseboard is faulty.
2	Parity Error	Parity error in the first 64 KB of memory.
3	Base 64 KB Memory Failure	Memory failure in the first 64 KB.
4	Timer Not Operational	Memory failure in the first 64 KB of memory, or Timer 1 on the baseboard is not functioning.
5	Processor Error	The CPU on the baseboard generated an error.
6	8042 - Gate A20 Failure	The keyboard controller (8042) may be bad. The BIOS cannot switch to protected mode.
7	Processor Exception Interrupt Error	The CPU generated an exception interrupt.
8	Display Memory Read/Write Error	The system video adapter is either missing or its memory is faulty. This is not a fatal error.
9	ROM Checksum Error	ROM checksum value does not match the value encoded in BIOS.
10	CMOS Shutdown Register Rd/Wrt Error	The shutdown register for CMOS RAM failed.
11	Cache Error / External Cache Bad	The external cache is faulty.

ERROR MESSAGES

<i>Error Message</i>	<i>Explanation</i>
8042 Gate - A20 Error	Gate A20 on the keyboard controller (8042) is not working. Replace the 8042.
Address Line Short!	Error in the address decoding circuitry on the baseboard.
Cache Memory Bad, Do Not Enable Cache!	Cache memory is defective. Replace it.
CH-2 Timer Error	Most AT systems include two timers. There is an error in timer 2.
CMOS Battery State Low	CMOS RAM is powered by a battery. The battery power is low. Replace the battery.
CMOS Checksum Failure	After CMOS RAM values are saved, a checksum value is generated for error checking. The previous value is different from the current value. Run AMIBIOS Setup.
CMOS System Options Not Set	The values stored in CMOS RAM are either corrupt or nonexistent. Run Setup.
CMOS Display Type Mismatch	The video type in CMOS RAM does not match the type detected by the BIOS. Run AMIBIOS Setup.
CMOS Memory Size Mismatch	The amount of memory on the baseboard is different than the amount in CMOS RAM. Run AMIBIOS Setup.

ERROR MESSAGES (CONT.)

CMOS Time and Date Not Set	Run Standard CMOS Setup to set the date and time in CMOS RAM.
Diskette Boot Failure	The boot disk in floppy drive A: is corrupt. It cannot be used to boot the system. Use another boot disk and follow the screen instructions.
Display Switch Not Proper	Some systems require a video switch on the baseboard be set to either color or monochrome. Turn the system off, set the switch, then power on.
DMA Error	Error in the DMA controller.
DMA #1 Error	Error in the first DMA channel.
DMA #2 Error	Error in the second DMA channel.
FDD Controller Failure	The BIOS cannot communicate with the floppy disk drive controller. Check all appropriate connections after the system is powered down.
HDD Controller Failure	The BIOS cannot communicate with the hard disk drive controller. Check all appropriate connections after the system is powered down.
INTR #1 Error	Interrupt channel 1 failed POST.
INTR #2 Error	Interrupt channel 2 failed POST.
Invalid Boot Diskette	The BIOS can read the disk in floppy drive A:, but cannot boot the system. Use another boot disk.
Keyboard Is Locked...Unlock It	The keyboard lock on the system is engaged. The system must be unlocked to continue.
Keyboard Error	There is a timing problem with the keyboard. Set the <i>Keyboard</i> option in Standard CMOS Setup to <i>Not Installed</i> to skip the keyboard POST routines.
KB/Interface Error	There is an error in the keyboard connector.
Off Board Parity Error	Parity error in memory installed in an expansion slot. The format is: OFF BOARD PARITY ERROR ADDR (HEX) = (XXXX) XXXX is the hex address where the error occurred.
On Board Parity Error	Parity error in baseboard memory. The format is: OFF BOARD PARITY ERROR ADDR (HEX) = (XXXX) XXXX is the hex address where the error occurred.
Parity Error ????	Parity error in system memory at an unknown address.

ISA NMI MESSAGES

<i>ISA NMI Message</i>	<i>Explanation</i>
Memory Parity Error at xxxxx	Memory failed. If the memory location can be determined, it is displayed as xxxxx. If not, the message is <i>Memory Parity Error ????</i> .
I/O Card Parity Error at xxxxx	An expansion card failed. If the address can be determined, it is displayed as xxxxx. If not, the message is <i>I/O Card Parity Error ????</i> .
DMA Bus Time-out	A device has driven the bus signal for more than 7.8 microseconds.

Appendix I – BIOS Recovery

The Classic/PCI board incorporates the AMIBIOS in a Flash memory component. Flash BIOS allows easy upgrades without the need to replace an EPROM. The upgrade utility fits on a floppy diskette and provides the capability to save, verify, and update the system BIOS. The upgrade utility can be run from a hard drive or a network drive, but no memory managers can be installed during upgrades.

The latest upgrade utility and BIOS code are available in the *BIOS* section of the iPAN bulletin board.

USING THE UPGRADE UTILITY

If the utility is obtained from the bulletin board, UNZIP the archive and copy the files to a bootable MS-DOS 3.3, 4.01, 5.0, or 6.0 diskette. Reboot the system with the upgrade diskette in the bootable floppy drive and follow the directions in the easy to use menu-driven program.

RECOVERY MODE

In the unlikely event that a FLASH upgrade is interrupted catastrophically, it is possible the BIOS may be left in an unusable state. Recovering from this condition requires the following steps (be sure a power supply and speaker have been attached to the board, and a floppy drive is connected as drive A:):

1. Change Flash Recovery jumper (RCVR FLASH) to the recovery mode position.
2. Install the bootable upgrade diskette into drive A:
3. Reboot the system.
4. Because of the small amount of code available in the non-erasable boot block area, no video is available to direct the procedure. The procedure can be monitored by listening to the speaker and looking at the floppy drive LED. When the system beeps and the floppy drive LED is lit, the system is copying the recovery code into the FLASH device. As soon as the drive LED goes off, the recovery is complete.
5. Turn the system off.
6. Change the Flash Recovery jumper back to the default position.
7. Leave the upgrade floppy in drive A: and turn the system on.
8. Continue with the original upgrade.

Appendix J – Environmental Standards

Parameter	Condition	Specification
Temperature	Non-Operating	-40°C to +70°C
	Operating	+0°C to +55°C
Humidity	Non-Operating	92% Relative Humidity max. @ 36°C
	Operating	80% Relative Humidity max. @ 36°C
Altitude	Non-Operating	50,000 feet (15,240 meters)
	Operating	10,000 feet (3048 meters)
ESD	1.0kV	No Errors
	2.5kV	No Errors
	5.0kV	5% Soft Errors, 0% Hard Errors, No physical damage
	7.5kV	10% Soft Errors, 0% Hard Errors, No physical damage
	10.0kV	25% Soft Errors, 5% Hard Errors, No physical damage
	12.5kV	50% Soft, 10% Hard, No physical damage
	15.0kV	100% Soft, 25% Hard, No physical damage
	25.0kV	100% Soft, 100% Hard, No physical damage
Shock	Non-Operating	30.0G, 11ms, 1/2 sine

Table J-1. Environmental Standards

Comentario [DS4]: Get MTBF figures.

Appendix K – Reliability Data

The Mean-Time-Between-Failures (MTBF) data is calculated from predicted data @ 55C.

Premiere/PCI Baby-AT baseboard

TBD (Testing in progress)

Appendix L – Customer Support

The Premiere/PCI II is backed by Intel's industry-leading support groups in the OEM Products and Services Division (OPSD), including IntelTechDirect, which includes these major services:

INTEL APPLICATIONS SUPPORT

- A direct link to highly qualified and well trained technical personnel.
- Toll-free access to Intel support engineers for problem resolution
- Responses within 24 hours Monday-Friday
- Expert assistance geared to the special needs of OEMs and VARs

INTEL APPLICATIONS SUPPORT BBS

- A full service bulletin board with product information, demo software and more.
- Available worldwide through direct-dial
 - Americas 916-356-3600
 - Europe 44-793-496340
- Modem speeds up to 14.4k baud with standard software
- FLASH BIOS upgrade files
- Modem set at no parity, 8 data bits, 1 stop bit.
- Master BBS file list and FaxBack catalog available at 800-897-2536.

WINDOWS HELP FILES

- Monthly Product updates available to qualified users on the bulletin board
- Official notification of engineering changes and technical data
- Easy information retrieval using Windows Help file format
- Intel platform system, board, and BIOS revision histories
- Hardware and software compatibility notes
- Documentation updates, spare parts and order information

FAXBACK

- Product descriptions and technical data sent to any fax machine from a touch-tone phone
- Information on End-of-Life products
- Available worldwide through direct dial
 - U.S. Toll Free 800-628-2283
 - Americas 916-356-3105
 - Europe 44-793-496646