

PCA-6741 STPC Consumer II

Half-Sized CPU Card

Startup Manual

Packing List

Before you begin installing your board, please make sure that the following materials have been shipped:

- 1 PCA-6741 Series Half-sized CPU card
- 1 startup manual (200K674110)
- 1 utility disk/CD driver (2066000412)
- 1 hard disk drive (IDE) interface cable (40-pin) (part no. 1701400601)
- 1 keyboard / PS2 mouse cable (part no. 1700060202)
- 1 COM port/Parallel port cable (part no. 1701260303)
- 1 floppy disk drive interface cable 700 mm (28") (part no. 1701340700)
- 1 Warranty Certificate

If any of these items are missing or damaged, contact your distributor or sales representative immediately.

Note 1: For detailed contents of the PCA-6741 Series please refer to the enclosed CD-ROM or disk (in PDF format).

Note 2: Acrobat Reader is required to view any PDF file. Acrobat Reader can be downloaded at: www.adobe.com/Prodindex/acrobat/readstep.html (Acrobat is a trademark of Adobe.)

For more information on this and other Advantech products, please visit our website at:

<http://www.advantech.com>
<http://www.advantech.com/epc>

For technical support and service, please visit our support website at:

<http://www.advantech.com/support>

This manual is for the PCA-6741 series Rev.A1

Part No. 200K674110
Printed in Taiwan

1st Edition
Dec. 2002

Specifications

Standard SBC Functions

- **CPU:** STMicroelectronics STPC Consumer II 133
- **BIOS:** AWARD 256 KB Flash BIOS
- **System memory:** Onboard 32 MB SDRAM and optional one SDRAM SODIMM socket supports up to 64 MB
- **Enhanced IDE interface:** Supports up to two IDE devices. PIO mode 3,4 with bus mastering up to 14 MB/sec.
- **FDD interface:** Supports up to two FDD devices
- **Serial ports:** One serial RS-232 port, one RS-232/422/485 port (PCA-6741F-0CA2 only)
- **Parallel port:** One parallel port, supports EPP/ECP mode
- **Infrared port:** One 115 K fast infrared (SIR) port, IrDA 1.1 compliant
- **Keyboard/mouse connector:** Mini-Din connector supports standard PC/AT keyboard and PS/2 mouse
- **Power management:** APM
- **Watchdog timer:** 1 ~ 62 sec. System reset or IRQ11

VGA Interface

- **Chipset:** Consumer II Embedded
- **Frame buffer:** Supports 1/2/4MB frame buffer with system memory
- **Display type:** Supports CRT
- **CRT display mode:** Non-interlaced CRT monitor resolutions up to 1280 x 1024 @ 8 bpp or 1024 x 768 @ 8 bpp

Ethernet Interface (PCA-6741F-0CA2 only)

- **Chipset:** RTL8139C
- **Ethernet interface:** PCI 10/100 Mbps Ethernet. IEEE 802.3 U protocol compatible
- **Connection:** On-board RJ-45 connector
- **I/O address switchless setting**
- **Built-in boot ROM**
- **Supports Wake-on-Lan**

Solid State Disk

- Supports DiskOnChip®
- Supports CompactFlash™ Type I/II (optional)

Mechanical and Environmental

- **Dimensions (L x W):** 185 mm x 122 mm
- **Power supply voltage:** +5 V (4.75 V ~ 5.25 V)
- **Power requirements:** 1.39A @ 5 V (32 MB SDRAM and DOS MODE)
- **Operating temperature:** 0 ~ 60° C (32 ~ 140° F)
- **Weight:** 0.27 kg (0.59 lbs.)

CN6: Multiple Connector

Pin	Function
1,3,5,7	External PCBEEP connector (5-7 Internal PCBEEP*)
2-4	Keyboard lock connector
6-8-10	Power LED connector
9-11	Reset connector
12-14-16-18-20	IR connector
13-15	HDD LED connector
17-19	ATX power button connector

CN6 Multiple connector location

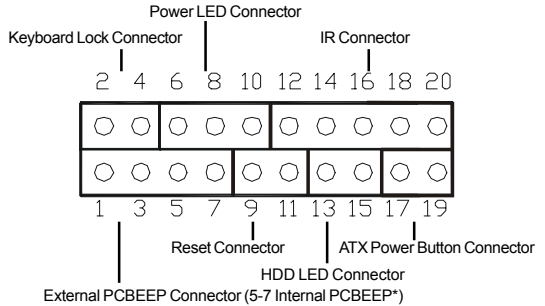

Jumpers and Connectors

Connectors on the board link it to external devices such as hard disk drives, a keyboard or expansion bus connectors. In addition, the board has a number of jumpers that allow you to configure your system to suit your application.

The tables below lists the function of each of the board's jumpers and connectors:

Table 2-1: Jumpers

Label	Function
J1	CMOS Charge & Discharge
J2	LAN Power select
JP2	RS-232/RS-422/RS-485 select
JP3	DOC® 2000 Address select
JP4	Watchdog timer

Table 2-2: Connectors

Label	Function
CN1	IDE connector
CN2	FDD connector
CN3	Printer port connector
CN5	Reserved
CN6	Multiple Connector
CN7	ATX Power Standby connector
CN9	CRT Connector
CN10	PC/104 connector
CN11	LAN connector
CN12	Reserved
CN13	COM2 connector (RS-422/RS-485)
CN14	COM2 connector (RS-232)
CN15	COM1 connector
CN16	Internal Keyboard connector
CN17	AT (Big 4P) Power connector
CN18	PS2 Keyboard/Mouse connector
CN19	ISA Gold-Finger connector
CN20	CompactFlash™ connector

J1: CMOS Charge & Discharge

Pin	Function
1-2	Discharge
2-3	Charge

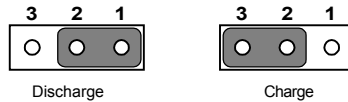

J2: LAN Power Select

Pin	Function
1-2	5 V Standby
2-3	VCC*

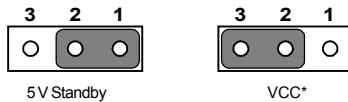

JP2: RS-232/422/485 Select

Pin	Function
1-2 (CN10 connector)	COM2/RS-232*
3-4 (CN11 connector)	COM2/RS-422
5-6 (CN11 connector)	COM2/RS-485

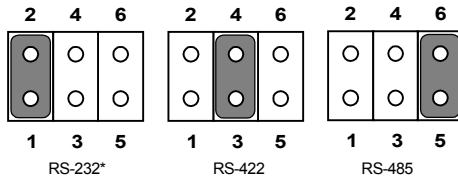

JP3: DOC address select

Pin	Address at
1-2	D4000h
3-4	DC000h
1-2, 3-4	CC000h
1-2, 5-6	D0000h
3-4, 5-6	D8000h

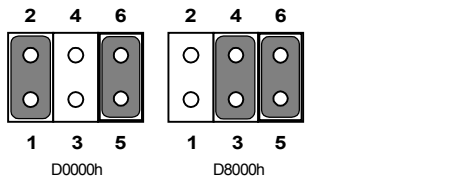
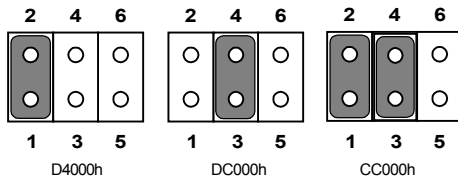

JP4: Watchdog timer

Pin	Function
1-2	Reset*
2-3	IRQ11

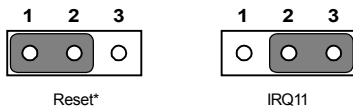

*Default Settings

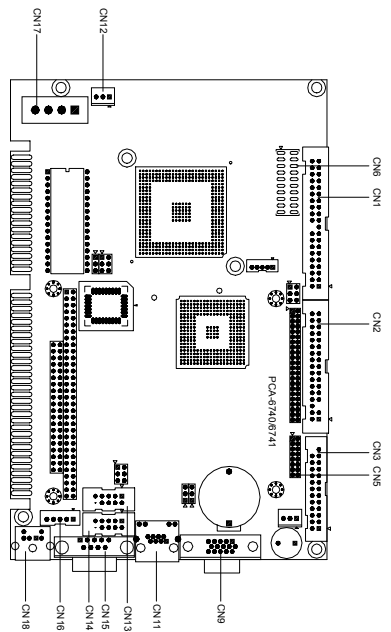

Locating connectors (component side)

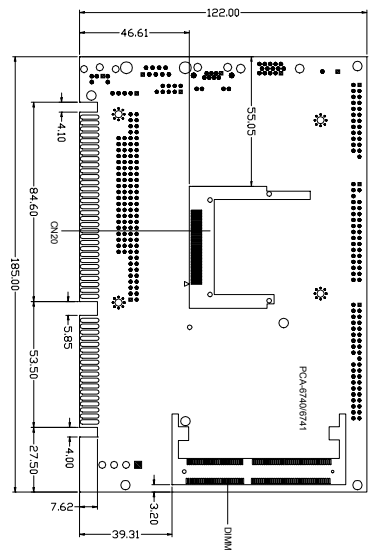

Locating connectors (solder side)

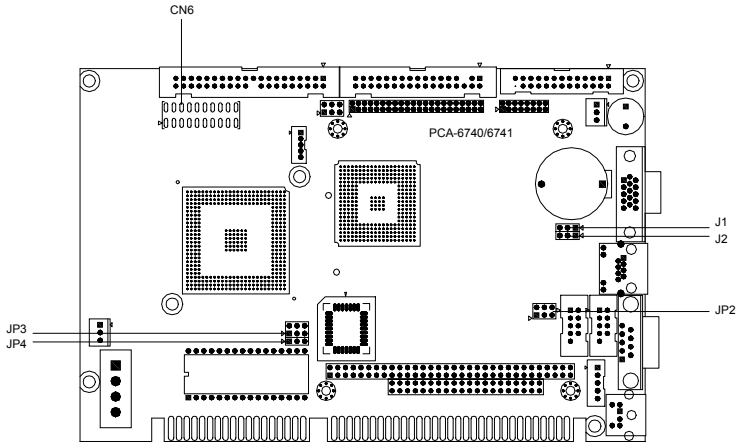

Locating Jumpers (component side)

Mechanical Drawing

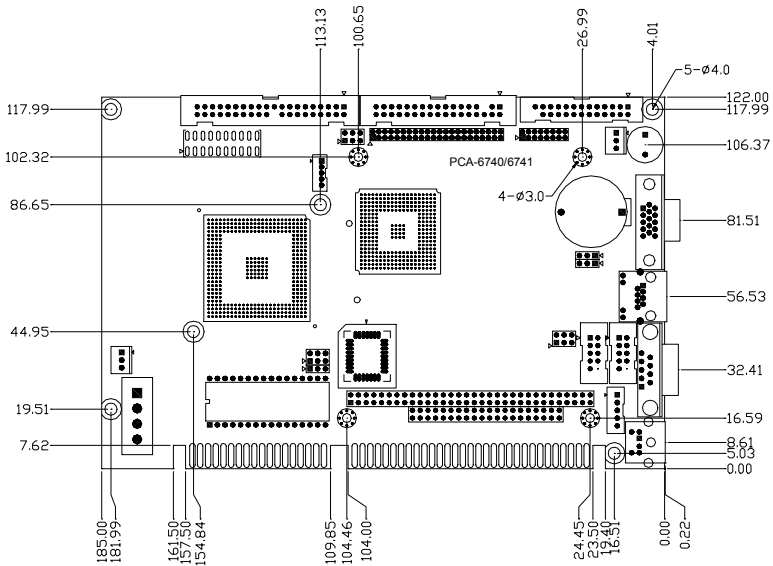

Board Dimensions (component side)