

PAM-0057I

High Performance
Pentium PCI Mainboard
User's Guide



Edition 3.02
© 1998 DTK Computer, Inc.

P/N: 155100-8573



High Performance Pentium PCI Mainboard

User's Manual

TRADEMARKS

Windows, MS-DOS, and MS Word are trademarks of Microsoft Corporation.

Novell, Netware are trademarks of Novell, Inc.

Lotus, 1-2-3, and Symphony are trademarks of Lotus Development Corporation.

PC, AT, PC-DOS, OS/2 and Presentation Manager are trademarks of IBM Corporation.

UNIX is the trademark of AT&T.

Intel 82430TX, Pentium is registered trademark of Intel Corp.

All other brand and product names are trademarks or registered trademarks of their respective companies.

The information presented in this publication has been carefully checked for reliability; however, no responsibility is assumed for inaccuracies, whereas, specification is subjected to change without notice.

RELIABILITY SPECIFICATIONS

Working Specifications

Actual Field MTBF (hours)	104,515 hours
Preventive Maintenance	Not Required

Environmental Limits

	Operating	Non-operating
Temperature	0 to 50 Degree Celsius	-10 to 65 Degree Celsius
Relative Humidity (without condensation)	8 to 85%	5 to 95%
Altitude	10,000ft	40,000ft

Power Specifications

Configuration: 133MHz Intel P54C CPU, 16MB 60ns EDO SIMM, 256KB Cache, 3.5 inch floppy drive, 840MB Hard Disk, running at DOS prompt.

DC Voltage	Tolerance	Consumption (mA)
+5V	+/- 5%	860
+5V Stand by	+/- 5%	0.5
+5V	+/- 5%	0
+12V	+/- 5%	200
-12V	+/- 5%	30

CONTENTS

CHAPTER 1	INTRODUCTION	1
1.1	GENERAL SPECIFICATION	1
1.2	MAINBOARD COMPONENTS	4
CHAPTER 2	MEMORY CONFIGURATION	5
2.1	SYSTEM MEMORY	5
2.2	CACHE MEMORY CONFIGURATION	7
CHAPTER 3	JUMPER SETTINGS AND CONNECTORS	9
3.1	CPU TYPE	9
3.1.1	INTEL PENTIUM CPU	9
3.1.2	INTEL PENTIUM w/ MMX™ TECH (P55C) CPU	10
3.1.3	AMD-K6 CPU	11
3.1.4	AMD-K5 CPU	12
3.1.5	CYRIX 6x86 CPU	13
3.1.6	CYRIX 6x86L CPU	14
3.1.7	CYRIX 6x86MX CPU	14
3.2	SETTING THE JUMPERS	15
3.3	CONNECTING THE MOTHERBOARD	18
3.3.1	JUMPER PRESENTATION	18
3.3.2	JUMPER CONVENTION OF THE MOTHERBOARD	18
3.3.3	CONNECTOR LOCATIONS	19
3.4	CONNECTORS	20
3.4.1	J2 - RESET SWITCH, SMI SWITCH, SPEAKER, TURBO LED, KEYLOCK AND HDD LED CONNECTOR	20
3.4.2	J10 - PRIMARY IDE CONNECTOR	23
3.4.3	J11 - SECONDARY IDE CONNECTOR	23
3.4.4	J12 - USB0, USB1, PS/2 MOUSE EXTENSION, IrDA AND FAST IR CONNECTOR	24
3.4.5	J13 - SERIAL PORT 2	25
3.4.6	J14 - SERIAL PORT 1	25
3.4.7	J15 - PARALLEL PORT	25
3.4.8	J16 - FLOPPY DRIVE CONTROLLER	25
3.4.9	J19 - PS/2 STYLE MOUSE CONNECTOR (OPTIONAL)	25

3.4.10	J20 - KEYBOARD CONNECTOR	26
3.4.11	J21 - PS/2 STYLE KEYBOARD CONNECTOR (OPTIONAL)	26
3.4.12	J22 - POWER SUPPLY CONNECTOR	27
3.5	GRAPHICAL DESCRIPTIONS OF JUMPER SETTINGS	28
3.5.1	CPU VOLTAGE SELECTION	29
3.5.2	CPU SPEED	32
CHAPTER 4	AWARD BIOS SETUP GUIDE	37
4.1	AWARD BIOS SETUP	37
4.2	STANDARD CMOS SETUP	39
4.3	BIOS FEATURES SETUP	41
4.4	CHIPSET FEATURES SETUP	44
4.5	POWER MANAGEMENT SETUP MENU	46
4.6	PnP/PCI CONFIGURATION	48
4.7	INTEGRATED PERIPHERALS SETUP MENU	50
4.8	LOAD SETUP DEFAULTS MENU	53
4.9	SUPERVISOR PASSWORD	53
4.10	USER PASSWORD	54
4.11	IDE HDD AUTO DETECTION	54
4.12	SCSI HARD DISK INSTALLATION	54
4.13	SAVE & EXIT SETUP MENU	55
4.14	EXIT WITHOUT SAVING MENU	55

CHAPTER 1 INTRODUCTION

The motherboard is a 4-layer, 2/3 baby AT size high-performance mainboard. It includes Intel 82430TX system chipset, Winbond W83877F/W83877TF Super I/O controller.

1.1 GENERAL SPECIFICATION

Processor

- Intel Pentium P54C, P55C series.
- Cyrix 6x86, Cyrix 6x86L; AMD-K5 and AMD-K6 series 64-bit microprocessors.
- The mainboard can run with following speeds:
90, 100, 110, 120, 133, 150, 166, 200 and 233 MHz

Chipset

- Intel 82439TX (Intel 82430TX System Controller)
- Intel 82371AB (PCI ISA IDE Xcelerator)
- Winbond W83877F (Super I/O Controller)

Cache Size

- Synchronised Pipelined Burst Mode SRAM to achieve the high Pentium system performance.
- Cache size is 0/256/512KB.

Main Memory

- Support Mixed Memory Technologies: EDO (Extend Data Output), Standard Page Mode (SPM), Fast Page Mode (FPM), and Synchronous DRAM (SDRAM) SIMM can work together.
- Memory configurations from 4MB to 256MB are possible using combination of 512K*32 to 8M*32 SIMM module (32Bits no-parity 72-pin SIMM Module) and 2M*32 to 8M*32 SDRAM DIMM Module.
- DIMM socket for SDRAM (3.3V unbuffered).

Multi I/O

- On board Multi-I/O supports two serial, one parallel ports and floppy drive controller.
- Serial ports are 16550 Fast UART compatible.
- Parallel port has EPP and ECP capabilities.
- PS/2 mouse and keyboard supported.
- IrDA supported.
- Dual standard USB (Universal Serial Bus) ports supported.

PCI IDE

- On board supports PCI Master IDE Controller, two connectors support up to four IDE devices such as HDD, CD ROM drive and Tape Back-up drives, etc.
- PCI Master IDE controller supports PIO Mode 3 and 4 devices, I/O data transfer rate can be up to 17Mb/s. DMA mode transfer rate can be up to 22Mb/s.
- Ultra DMA mode supported. Transfer rate can be up to 33Mb/s.

System BIOS

- Award BIOS (128KB Flash EPROM).

Slots

- Four PCI slots
- Four ISA slots

Board

- 4 Layer

Form Factor

- 2/3 Baby AT Size (220 x 260mm)

1.2 MAINBOARD COMPONENTS

This section gives a brief description of key components on the mainboard. Please refer to Fig. 1 for components location.

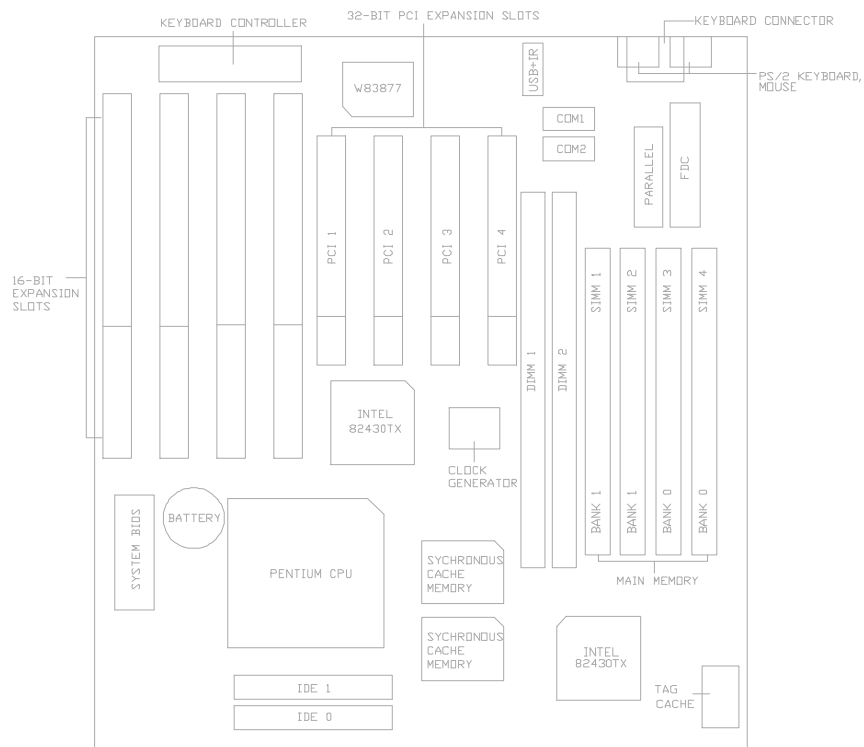

Fig. 1 Key Components of the Mainboard

CHAPTER 2 MEMORY CONFIGURATION

2.1 SYSTEM MEMORY

The Mainboard lets user upgrade system memory via SIMM sockets and DIMM sockets on the mainboard.

Four SIMM sockets (SIMM1, SIMM2, SIMM3, SIMM4) are provided for SPM, FPM and EDO RAM SIMM and two DIMM sockets (DIMM1, DIMM2) are available for the SDRAM or 3.3V EDO DIMM.

Note: *The type of SIMM1/SIMM2 must be same.
The type of SIMM3/SIMM4 must be same.
SIMM3/SIMM4 and DIMM1 cannot co-exist.
SIMM1/SIMM2 and DIMM2 cannot co-exist.*

Table 1 provides some typical memory configurations supported by the mainboard.

Onboard memory is located in two banks:

Bank 0: SIMM3 & SIMM4
OR
DIMM1

Bank 1: SIMM1 & SIMM2
OR
DIMM2

The total memory size is 8-256MB and various configuration of DRAM types in the following table are for reference:

Bank 0 (SIMM 3,4/DIMM1)	Bank 1 (SIMM 1,2/DIMM2)
Single	None
None	Single
Single	Single
Single	Double
Double	Single
Double	None
None	Double
Double	Double

Table 1: Memory Configuration

Single means Single side SIMM Module or Single side DIMM Module. The size of Single side SIMM can be 4MB, 16MB, 64MB and the size of Single side DIMM can be 8MB, 32MB, 128MB.

Double means Double side SIMM Module or Double side DIMM Module. The size of Double side SIMM can be 8MB, 32MB and the size of Double side DIMM can be 16MB, 64MB.

****Note:** *based on above chart, the different types of SIMM can be in different bank, but within same bank, the two SIMM modules must be of same type and size. Moreover, it is not recommended to installed the 5V SIMM and 3.3V DIMM at the same time.*

2.2 CACHE MEMORY CONFIGURATION

The mainboard has a built-in cache controller. It requires external SRAM as tag and data memory.

Cache Tag RAM Location: U9

Synchronous Pipeline Burst SRAM Location: U5, U6

Cache Size	Tag RAM (U9)	Data RAM (U5, U6)
256K	8Kx8/16Kx8	32Kx32
512K	16Kx8	64Kx32

Table 2: Secondary Cache Configuration

**Note: Tag RAM are all 5V device, Pipeline Burst data RAM are 3.3V device e.g. Winbond W259022AF.*

This page is blank

CHAPTER 3

JUMPER SETTINGS AND CONNECTORS

3.1 CPU TYPE

3.1.1 INTEL PENTIUM CPU

The pentium processors have different operation voltage. In order to using the CPU Voltage correctly, the following is the marking for identify the CPU type.



**Fig. 2a CPU Description
(Bottom Side)**

Description :

X = Voltage Specification (S or V)

S = Standard Voltage (3.4V)

V = VRE 3.4 - 3.6V (3.5V)

Y = Timing Specification (S or M)

S = Standard EDS timings

M = Min Valid Delay Spec.

Z = Dual Processing Support (S or U)

S = Support DP/MP/UP

U = Not tested to support DP

3.1.2 INTEL PENTIUM w/ MMX™ TECH (P55C) CPU

The Intel Pentium w/ MMX™ Tech (P55C) CPU is offered with dual voltage supply - 2.8V for core and 3.3V for I/O interface. The following is the marking for identify the CPU type. (The following diagram is provided as an example only. It does not necessarily indicate a valid product marking.)

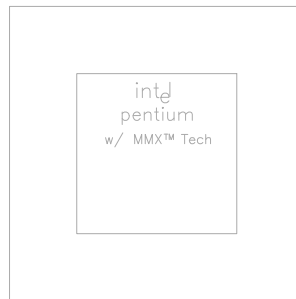
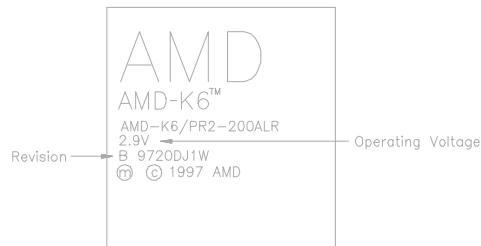

**Fig. 2b CPU Description
(Top Side)**

	I/O Voltage	Core Voltage
Intel Pentium w/ MMX™ Tech (P55C)	3.3V	2.8V

3.1.3 AMD-K6 CPU

The AMD-K6 CPU family require dual voltage power for operation. The AMD-K6/166 and AMD-K6/200 require a voltage of 2.9V for the core and 3.3V for the I/O. The AMD-K6/233 require a voltage of 3.2V for the core and 3.3V for the I/O. (The following diagram is provided as an example only. It does not necessarily indicate a valid product marking.)

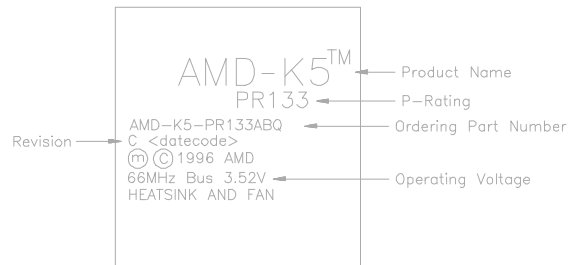

**Fig. 2c CPU Description
(Top Side)**

Operating Voltage	I/O Voltage	Core Voltage
2.2V	3.3V	2.2V
2.9V	3.3V	2.9V
3.2V	3.3V	3.2V

3.1.4 AMD-K5 CPU

The AMD-K5 family CPU is operated on different operation voltage depending on the CPU Type. The operating voltage can be known through the marking on the surface of the CPU. (The following diagram is provided as an example only. It does not necessarily indicate a valid product marking.)



**Fig. 2d CPU Description
(Top Side)**

3.1.5 CYRIX 6x86 CPU

The Cyrix 6x86 has different nominal voltage depends on different lot. Please refer to the CPU marking.

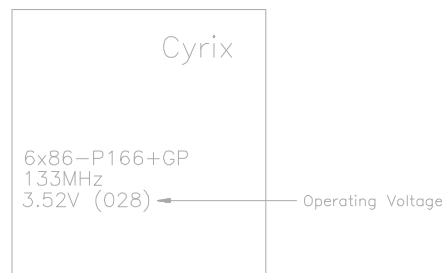

**Fig. 2e CPU Description
(Top Side)**

Marketing	Recommended Nominal Voltage
3.3V or 3.52V	3.52V
028	3.52V
016	3.3V
Blank	3.52V

3.1.6 CYRIX 6x86L CPU

The Cyrix 6x86L has different I/O and core voltage. Please refer to the CPU marking.



**Fig. 2f CPU Description
(Top Side)**

3.1.7 CYRIX 6x86MX CPU

The Cyrix 6x86MX has different I/O and Core Voltage. Please refer to the CPU marking.



**Fig. 2g CPU Description
(Top Side)**

	I/O Voltage	Core Voltage
Cyrix 6x86MX CPU	3.3V	2.9V
Cyrix 6x86L CPU	3.3V	2.8V

3.2 SETTING THE JUMPERS

The table below summaries the functions and settings of each jumper of the motherboard.

Function		Jumper Settings
CPU Voltage Selection	3.3V Single Voltage CPU For P54C, P54CT	JP1: short JP5: short JP7: A-B open 1-2 short 3-4 short 5-6 short
	3.5V Single Voltage CPU For P54C-VRE, AMD-K5, Cyrix 6x86	JP1: short JP5: short JP7: A-B short 1-2 short 3-4 short 5-6 short
	3.3V (I/O)/2.2V (core) Dual Voltage CPU For AMD-K6/233 or 266	JP1: open JP5: open JP7: A-B open 1-2 short 3-4 open 5-6 open
	3.3V (I/O)/2.8V (core) Dual Voltage CPU For P55C, Cyrix 6x86L	JP1: open JP5: open JP7: A-B open 1-2 open 3-4 open 5-6 short
	3.3V (I/O)/2.9V (core) Dual Voltage CPU For AMD-K6/166, 200, Cyrix 6x86MX-PR166/200	JP1: open JP5: open JP7: A-B short 1-2 open 3-4 open 5-6 short
To be continued...		

Table 3A: Jumper Setting

Function		Jumper Settings
CPU Voltage Selection	3.3V (I/O)/3.2V (core) Dual Voltage CPU For AMD-K6/233	JP1: open JP5: open JP7: A-B short 1-2 open 3-4 short 5-6 short
CPU Speed Selection	For 90MHz Intel Pentium, AMD-K5-PR90 and AMD-K5-PR120 CPU	JP9: 1-2 short JP10: 1-2 short JP12: 1-2 short 3-4 open JP13: 1-2 short
	For 100MHz and 233MHz Intel Pentium, AMD-K6/233, AMD-K5-PR100 and AMD-K5-PR150 CPU	JP9: 1-2 short JP10: 1-2 short JP12: 1-2 open 3-4 open JP13: 1-2 short
	For 110MHz Cyrix 6x86-P133+ CPU	JP9: 2-3 short JP10: 1-2 short JP12: 1-2 short 3-4 short JP13: 1-2 short
	For 120MHz Intel Pentium, Cyrix 6x86-P150+ CPU	JP9: 2-3 short JP10: 1-2 short JP12: 1-2 short 3-4 open JP13: 1-2 short
	For 133MHz Intel Pentium, AMD-K5-PR133 (REV C) and Cyrix 6x86-P166+ CPU	JP9: 2-3 short JP10: 1-2 short JP12: 1-2 open 3-4 open JP13: 1-2 short
	For 150MHz Intel Pentium, Cyrix 6x86MX-PR166 CPU	JP9: 2-3 short JP10: 2-3 short JP12: 1-2 short 3-4 open JP13: 1-2 short
To be continued...		

Table 3B: Jumper Setting

	Function	Jumper Settings
CPU Speed Selection	For 150MHz Cyrix 6x86-P200+ CPU (for future support only)	JP9: 2-3 short JP10: 1-2 short JP12: 1-2 open 3-4 short JP13: 1-2 short
	For 166MHz Intel Pentium, AMD-K6/166 and AMD-K5-PR166, Cyrix 6x86MX-PR200 CPU	JP9: 2-3 short JP10: 2-3 short JP12: 1-2 open 3-4 open JP13: 1-2 short
	For 200MHz Intel Pentium and AMD-K6/200 CPU	JP9: 1-2 short JP10: 2-3 short JP12: 1-2 open 3-4 open JP13: 1-2 short
	For 266MHz AMD-K6/266 CPU (for future support only)	JP9: 2-3 short JP10: 1-2 short JP12: 1-2 open 3-4 open JP13: 2-3 short
System ROM Selection	5V Flash EPROM	JP4: 1-2 short
	12V Flash EPROM	JP4: 2-3 short

Table 3C: Jumper Setting

3.3 CONNECTING THE MOTHERBOARD

Once the mainboard have been fastened into the system case, the next step is to connect the internal cables. The internal cables are wire leads with plastic female connectors that attach to the connectors. The mainboard connectors have varying numbers of pins and are the points of contact between the mainboard and other parts of the computer.

A description of each connector and its connector pins follows. See Fig. 3 for the location of the connectors on the mainboard.

Note: Before making connectors on the board, make sure that power to the system is turned off.

3.3.1 JUMPER PRESENTATION

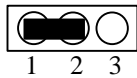

Pins 1 and 2 are shorted with a jumper cap.

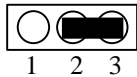

Pins 2 and 3 are shorted with a jumper cap.



The jumper is shorted when the jumper cap is placed over the two pins of the jumper.



The jumper is open when the jumper cap is removed from jumper.

3.3.2 JUMPER CONVENTION OF THE MOTHERBOARD

Different colour of jumper caps (mini-jumpers) are used on the board to represent different usage of the jumpers:

Red : CPU Clock setting

Black: Other

3.3.3 CONNECTOR LOCATIONS

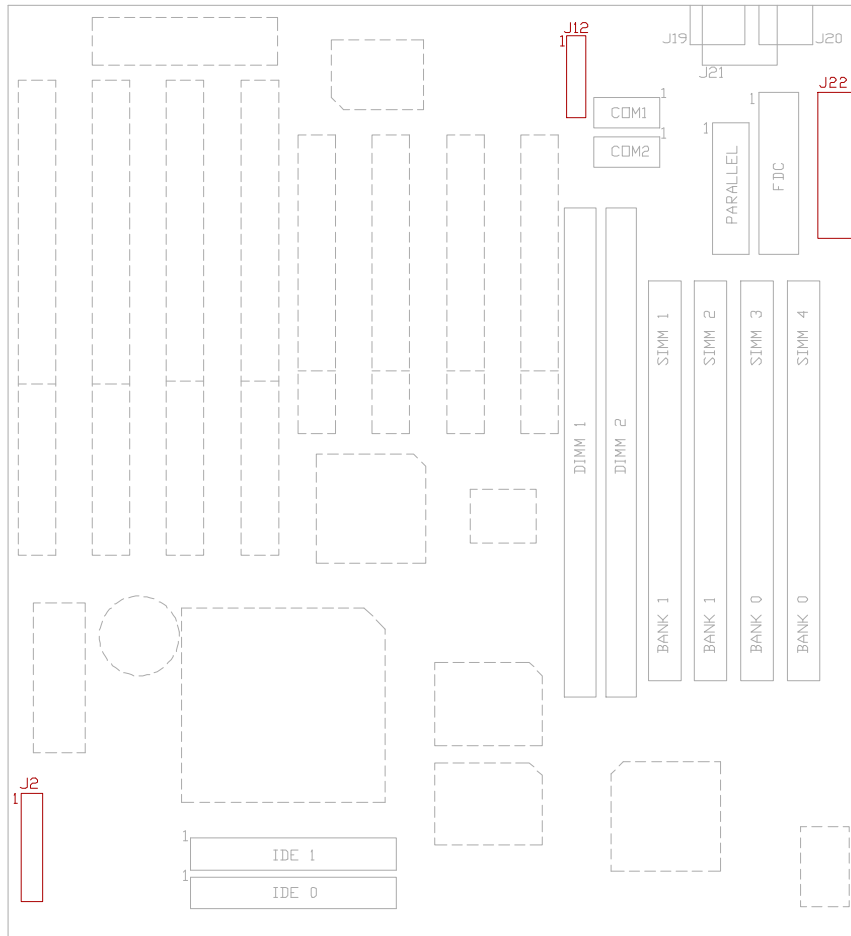

Fig. 3 Connector Location

3.4 CONNECTORS

3.4.1 J2 - RESET SWITCH, SMI SWITCH, SPEAKER, TURBO LED, KEYLOCK AND HDD LED CONNECTOR

J2 is a 2x10 pin header for Hard Disk LED, Keyboard Lock, Turbo LED, Suspense Switch, Reset Switch and Speaker Connector.

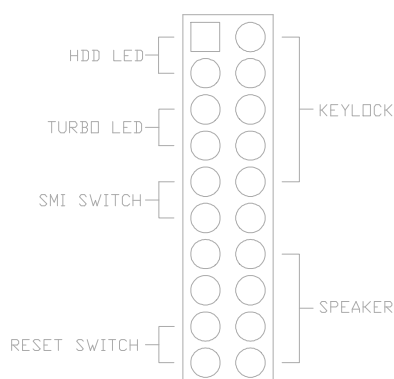

Fig. 4

- **RESET SWITCH CONNECTOR**

Attach the Reset switch cable to this connector. The Reset switch restarts the system. Please refer to Fig. 4.

	Reset
	Normal (default)

Table 4: Reset Switch Connector

- **SMI SWITCH**

Trigger this switch will put the system into suspend immediately.
Please refer to Fig. 4.

- **Speaker Connector**

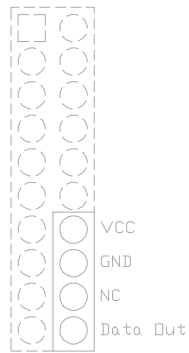

Fig. 5 Speaker Connector

- **TURBO LED CONNECTOR**

Turbo LED on front of the system case. If the system board select is in Turbo mode, the indicator lights during high-speed operation. This motherboard always operate at high-speed.

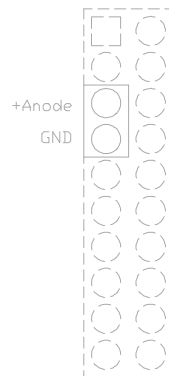

Fig. 6 Turbo LED

- **KEYLOCK CONNECTOR**

Close this jumper will disable the keyboard.

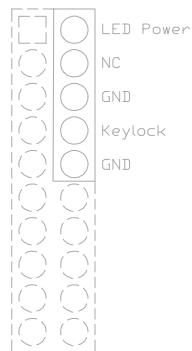

Fig. 7 Keylock Connector

- **HDD LED CONNECTOR**

Connected this jumper to the HDD LED on front of the system case. If the HDD is in operation, the indicator lights during operation.

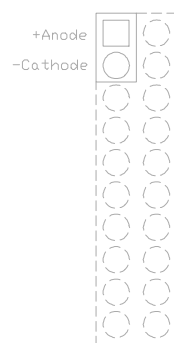

Fig. 8 HDD LED

3.4.2 J10 - PRIMARY IDE CONNECTOR

It locates below the CPU socket with pin 1 on the left.

3.4.3 J11 - SECONDARY IDE CONNECTOR

J11 locates above the J10, the primary IDE connector with pin 1 on the left.

3.4.4 J12 - USB0, USB1, PS/2 MOUSE EXTENSION, IrDA AND FAST IR CONNECTOR

J12 is a 2x10 pin header for USB0, USB1, PS/2 mouse extension, IrDA and Fast IR connector, and it is also designed as the connector for the optional USB extension card.

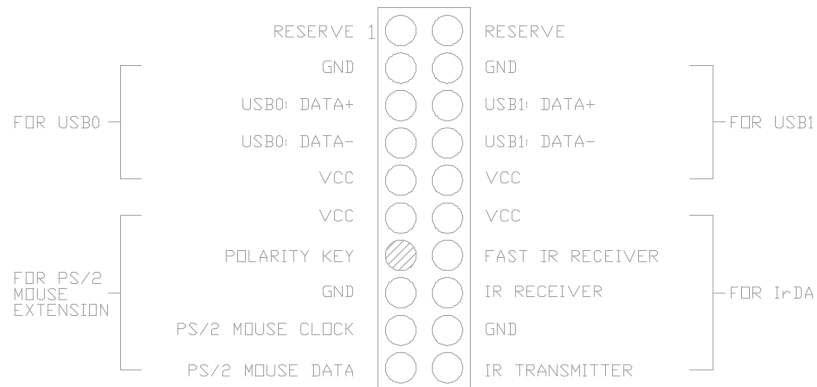

Fig. 9a

The attached PS/2 mouse extension cable is installed as follows:

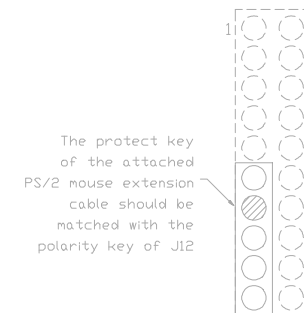

Fig. 9b

3.4.5 J13 - SERIAL PORT 2

J13 is left to J14. Pin 1 is on the right.

3.4.6 J14 - SERIAL PORT 1

Both COM1 and 2 are 16550 fast UART compatible. J14 is located right of J15 Parallel Connector. Pin 1 is on the right.

3.4.7 J15 - PARALLEL PORT

J15 is up to DRAM SIMM Module connector. Pin 1 is on the up left hand side.

3.4.8 J16 - FLOPPY DRIVE CONTROLLER

J16 locates right to Parallel Connector. This Floppy drive controller also supports 2.88M FDD format.

3.4.9 J19 - PS/2 STYLE MOUSE CONNECTOR (OPTIONAL)

A PS/2 Standard six-pin female DIM connector for mouse is located at left of the J20.

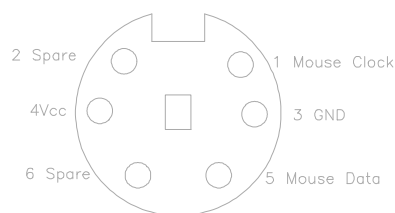

Fig. 10 J19 - PS/2 Mouse Connector

3.4.10 J20 - KEYBOARD CONNECTOR

A standard five-pin female DIM keyboard connector is located at the rear of the keyboard. Plug the jack on the keyboard cable into this connector.

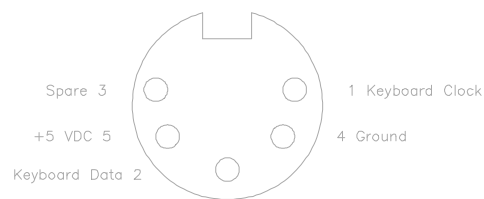

Fig. 11 J20 Keyboard Connector

3.4.11 J21 - PS/2 STYLE KEYBOARD CONNECTOR (OPTIONAL)

A PS/2 Standard six-pin female DIM connector for keyboard is located at right to J20.

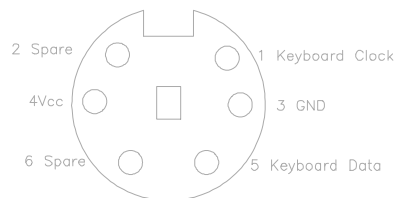

Fig. 12 J21 - PS/2 Mouse Connector

3.4.12 J22 - POWER SUPPLY CONNECTOR

The power supply connector has two six-pin male header connectors. Plug the dual connectors from the power directly onto the board connector.

Pin	Description
1	Power Good (Orange)
2	+5 VDC (Red)
3	+12 VDC (Yellow)
4	-12 VDC (Blue)
5	Ground (Black)
6	Ground (Black)
7	Ground (Black)
8	Ground (Black)
9	-5 VDC (White)
10	+5 VDC (Red)
11	+5 VDC (Red)
12	+5 VDC (Red)

Table 5: J22 - Power Supply Connector

3.5 GRAPHICAL DESCRIPTIONS OF JUMPER SETTINGS

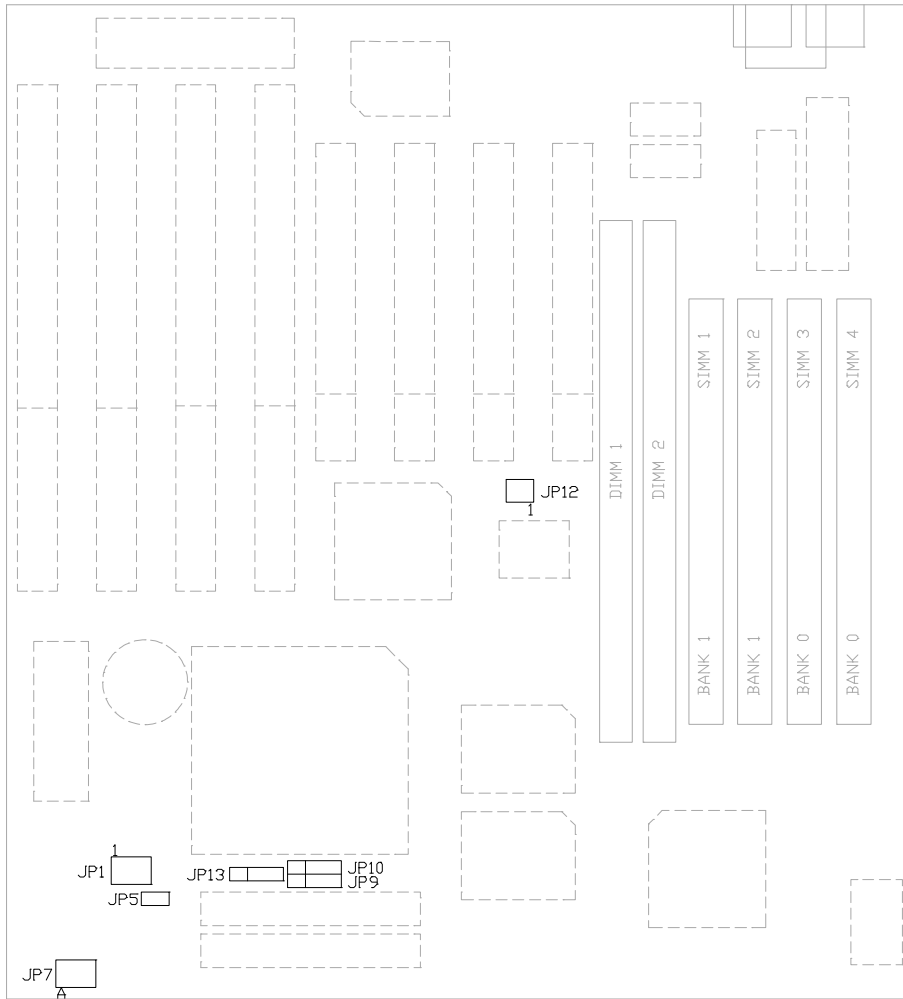

Fig. 13 Jumper Location

3.5.1 CPU VOLTAGE SELECTION

1. 3.3V Single Voltage CPU: P54C, P54CT

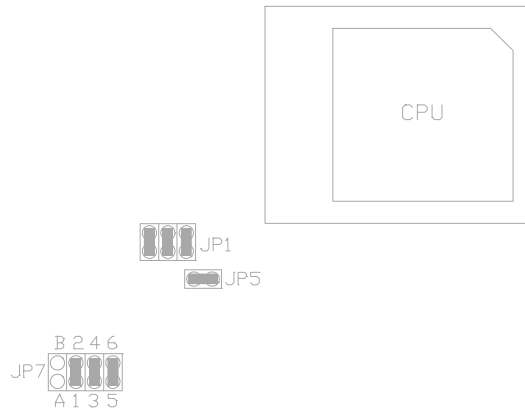

Fig. 14a CPU Type - 3.3V

2. 3.5V Single Voltage CPU: P54C-VRE, AMD-K5, Cyrix 6x86

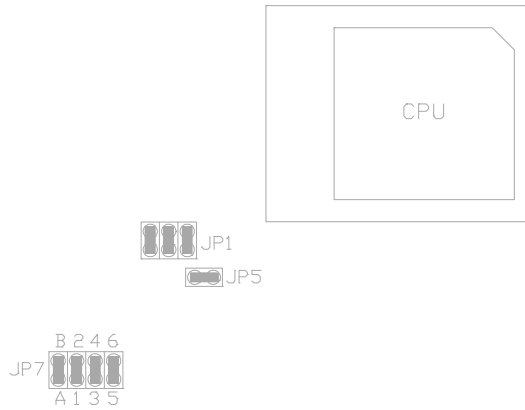

Fig. 14b CPU Type - 3.5V

3. 3.3V (I/O)/2.2V (core) Dual Voltage CPU: AMD-K6/233 or 266

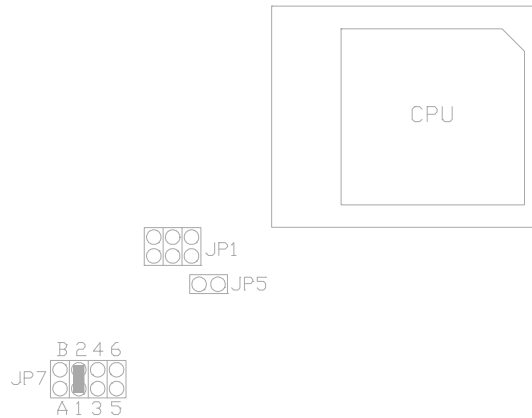

Fig. 14c CPU Type – 3.3V/2.2V

4. 3.3V (I/O)/2.8V (core) Dual Voltage CPU: P55C, Cyrix 6x86L

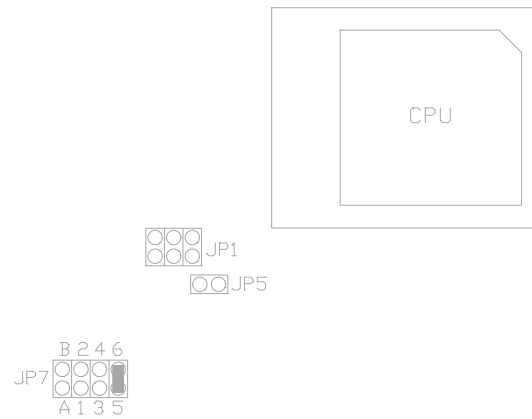

Fig. 14d CPU Type - 3.3V/2.8V

5. 3.3V (I/O)/2.9V (core) Dual Voltage CPU: AMD-K6/166, 200, Cyrix 6x86MX-PR166/200

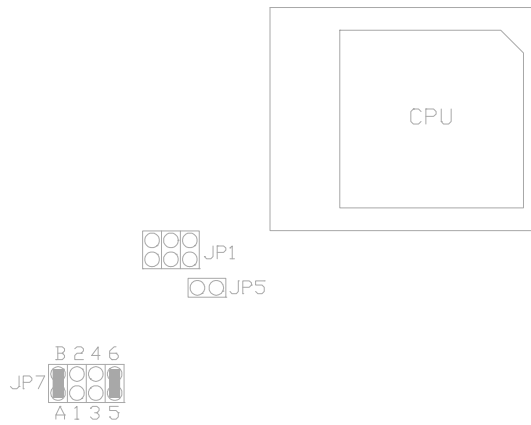

Fig. 14e CPU Type - 3.3V/2.9V

6. 3.3V (I/O)/3.2V (core) Dual Voltage CPU: AMD-K6/233

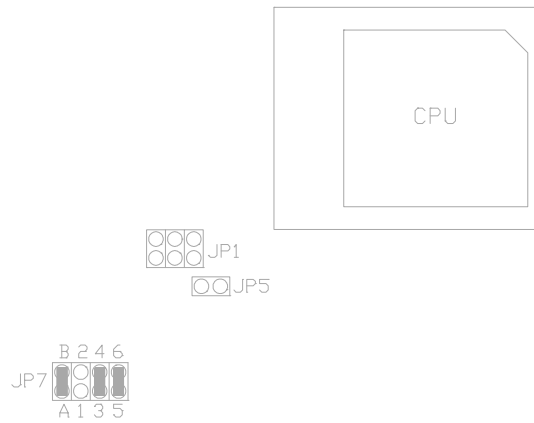

Fig. 14f CPU Type - 3.3V/3.2V

3.5.2 CPU SPEED

1. For 90MHz Intel Pentium, AMD-K5-PR90 and AMD-K5-PR120 CPU

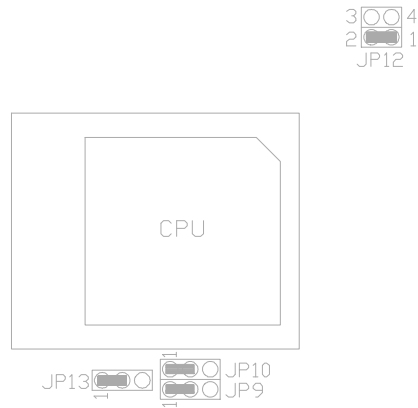

Fig. 15a CPU Speed

2. For 100MHz and 233MHz Intel Pentium, AMD-K6/233, AMD-K5-PR100 and AMD-K5-PR150 CPU

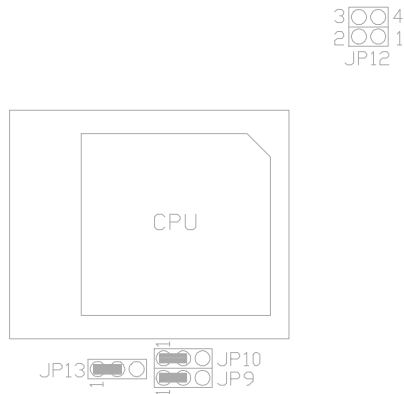

Fig. 15b CPU Speed

- 3. For 110MHz Cyrix 6x86-P133+ CPU

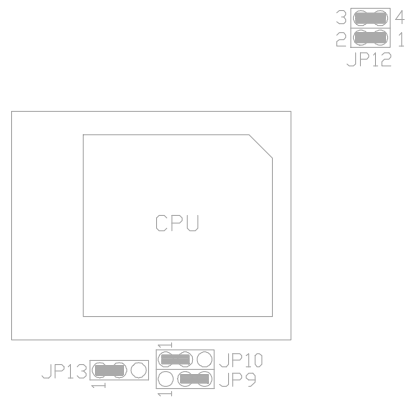

Fig. 15c CPU Speed

- 4. For 120MHz Intel Pentium and Cyrix 6x86-P150+ CPU

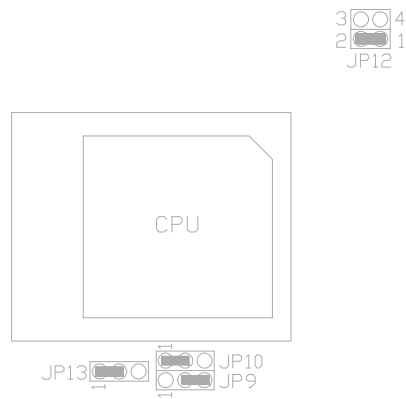

Fig. 15d CPU Speed

5. For 133MHz Intel Pentium, AMD-K5-PR133 (REV C) and Cyrix 6x86-P166+ CPU

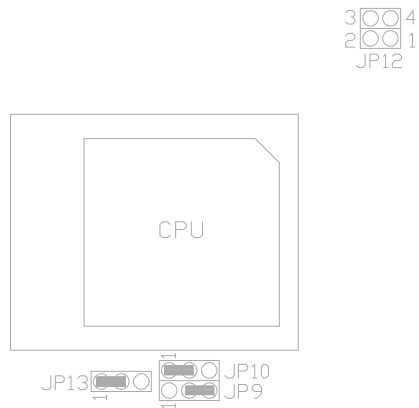

Fig. 15e CPU Speed

6. For 150MHz Intel Pentium, Cyrix 6x86MX-PR166 CPU

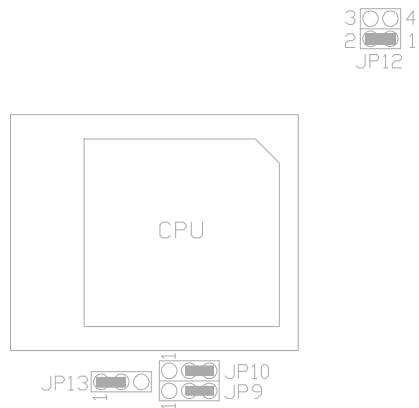

Fig. 15f CPU Speed

7. For 150MHz Cyrix 6x86-P200+ CPU (for future support only)

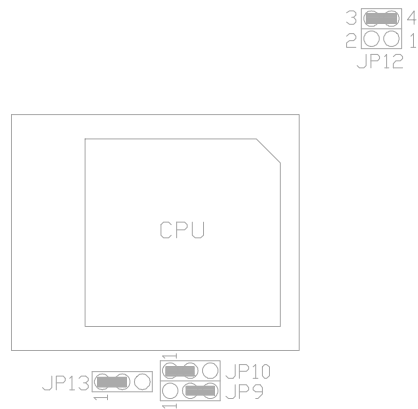

Fig. 15g CPU Speed

8. For 166MHz Intel Pentium, AMD-K6/166 and AMD-K5-PR166, Cyrix 6x86MX-PR200 CPU

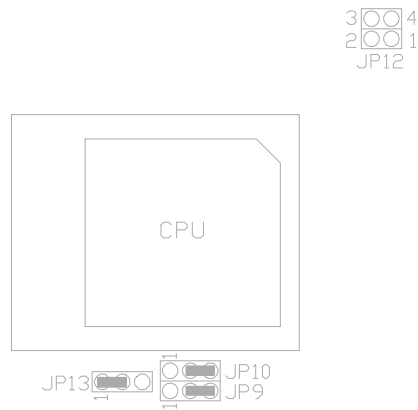

Fig. 15h CPU Speed

9. For 200MHz Intel Pentium and AMD-K6/200 CPU

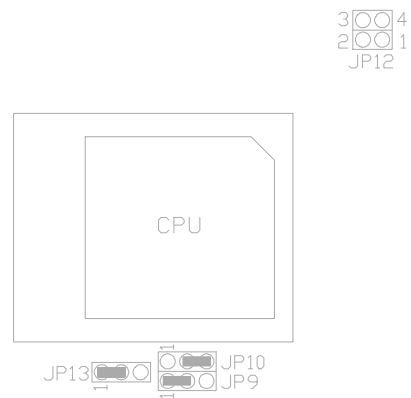

Fig. 15i CPU Speed

10. For 266MHz AMD-K6/266 CPU (for future support only)

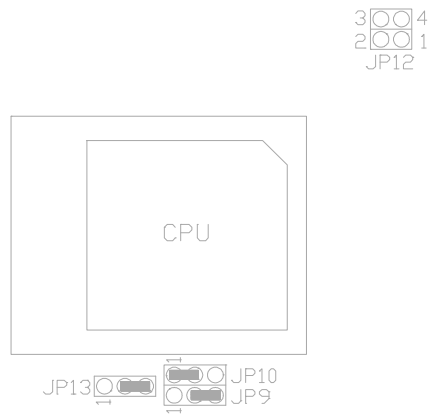

Fig. 15j CPU Speed

CHAPTER 4

AWARD BIOS SETUP GUIDE

This following manual is specially provided for the BIOS supported system. After the configuration of the mainboard, and have assembled the components, user can turn on the completed system. At this point, run the software setup to ensure that the system information is correct.

The software setup of the system board is achieved through Basic Input-Output System (BIOS) programming. Use the BIOS setup program to tell the operating system what type of devices (such as disk drives) are connected to the system board.

The system setup is also called CMOS setup. Normally, users need to run system setup if either the hardware configuration is not identical with information contained in the CMOS RAM, or the CMOS RAM has lost power.

4.1 AWARD BIOS SETUP

The setup program provided with mainboard is the Award BIOS from Award Software, Inc. Enter the AWARD Setup program's Main Menu as follows:

1. Turn on or reboot the system. After a series of diagnostic check, the following message appear:

“Press DEL to enter SETUP”

2. Press the key to enter the AWARD BIOS setup program and the following screen appears:

ROM PCI/ISA BIOS (2A59ID19)
CMOS SETUP UTILITY
AWARD SOFTWARE, INC.

STANDARD CMOS SETUP	INTEGRATED PERIPHERALS
BIOS FEATURES SETUP	SUPERVISOR PASSWORD
CHIPSET FEATURES SETUP	USER PASSWORD
POWER MANAGEMENT SETUP	IDE HDD AUTO DETECTION
PNP/PCI CONFIGURATION	HDD LOW LEVEL FORMAT
LOAD BIOS DEFAULTS	SAVE & EXIT SETUP
LOAD SETUP DEFAULTS	EXIT WITHOUT SAVING
Esc : Quit F10 : Save & Exit Setup	↑ ↓ → ← : Select Item (Shift)F2 : Change Color
Time, Data, Hard Disk Type...	

Fig. 16

3. Choose an option and press <Enter>. Modify the system parameters to reflect the options installed in the system. (see the following sections for more information).
4. Press <ESC> at anytime to return to the Main Menu.

- In the Main Menu, choose "SAVE AND EXIT SETUP" to save change and reboot the system. Choosing "EXIT WITHOUT SAVING" to ignore all changes and exits the program.

4.2 STANDARD CMOS SETUP

ROM PCI/ISA BIOS (2A59ID19)
 STANDARD CMOS SETUP
 AWARD SOFTWARE, INC.

Date (mm:dd:yy) : Mon, Feb 03 1997								
Time (hh:mm:ss) : 15 : 23 : 15								
HARD DISKS	TYPE	SIZE	CYLS	HEAD	PRECOMP	LANDZ	SECTOR	MODE
Primary Master	: Auto	0	0	0	0	0	0	AUTO
Primary Slave	: None	0	0	0	0	0	0	-----
Secondary Master	: None	0	0	0	0	0	0	-----
Secondary Slave	: None	0	0	0	0	0	0	-----
Drive A : 1.44M , 3.5in.					Base Memory: 640K			
Drive B : None					Extended Memory: 7168K			
Video : EGA/VGA					Other Memory: 384K			
Halt On : All Errors					Total Memory: 8192K			
Esc : Quit			↑ ↓ → ← : Select Item			PU/PD/+/- : Modify		
F1 : Help			(Shift)F2 : Change Color					

Fig. 17 Standard CMOS Setup Menu

Date(mm/dd/yy) Type the current date.

Time(hh:mm:ss) Type the current time.

Hard Disks	Choose from the standard hard disk types 1 to 45. Type 47 is user definable. Type Auto is for auto detect the hard disk type.
Drive A&B	Choose 360K, 5.25 in. 1.2M, 5.25 in. 720K, 3.5 in. 1.44M, 3.5 in. 2.88MB 3.5 in. or None
Video	Choose EGA/VGA, CGA 40, CGA 80, or MONO,
Halt On	Choose All Errors No Errors, All, But Keyboard, All, But Diskette, or All, But Disk/Key

4.3 BIOS FEATURES SETUP

ROM PCI/ISA BIOS (2A59ID19)
 BIOS FEATURES SETUP
 AWARD SOFTWARE, INC.

Virus Warning	: Disabled	Video BIOS Shadow	: Enabled
CPU Internal Cache	: Enabled	C8000-CBFFF Shadow	: Disabled
External Cache	: Enabled	CC000-CFFFF Shadow	: Disabled
Quick Power On Self Test	: Disabled	D0000-D3FFF Shadow	: Disabled
Boot Sequence	: A,C	D4000-D7FFF Shadow	: Disabled
Swap Floppy Drive	: Disabled	D8000-DBFFF Shadow	: Disabled
Boot Up Floppy Seek	: Enabled	DC000-DFFFF Shadow	: Disabled
Boot Up Numlock Status	: On		
Boot Up System Speed	: High		
Gate A20 Option	: Fast		
Typematic Rate Setting	: Disabled		
Typematic Rate (Chars/Sec)	: 6		
Typematic Delay (Msec)	: 250		
Security Option	: Setup		
PCI/VGA Palette Snoop	: Disabled		
OS Select For DRAM > 64MB	: Non-OS2		
		ESC: Quit ↑ ↓ → ←: Select Item F1: Help PU/PD/+/-: Modify F5: Old Values (Shift)F2: Color F7: Load Setup Defaults	

Fig. 18 BIOS Setup Defaults

A short description of the screen items follows:

Virus Warning: Enable Virus from invading the Boot area in either Hard Disk or Floppy Drive.

CPU Internal Cache: Choose Enabled or Disabled. This option lets user choose whether to use CPU internal cache memory. The default is Enabled.

External Cache: Choose Enabled or Disabled. This option lets user choose whether to use secondary cache memory. The default is Enabled.

Quick Power On Self Test: Choose Enabled or Disabled. This option let the POST sequence runs longer for through tests.

Boot Sequence: With the default setting the BIOS first attempts to boot from drive A: and then, if unsuccessful, from hard disk C:. User can reverse this sequence with "C: A:", but then drive A: cannot boot directly.

Swap Floppy Drive: Choose Enabled or Disabled. This option lets end users to change the Drive A: or B: to others.

Boot Up Floppy Seek: Choose Enabled or Disabled. "Disabled" provides a fast boot and reduces the possibility of damage to the heads.

Boot Up NumLock Status: Choose On or Off. On puts numeric keypad in Num Lock mode at boot-up. Off puts numeric keypad in arrow key mode at boot-up.

Boot Up System Speed: Choose High or Low. Set the CPU timing at Boot Up, the default is high.

Gate A20 Option: Choose Fast or Slow. The system switch back an forth from real mode to virtue mode, fast means the system will switch through logic, slow through keyboard. The default is Fast.

Typematic Rate Setting: Choose Enabled or Disabled. Enabled will determines the typematic rate defined by following two options.

Typematic Rate: The number selected 6,8,10... indicates how fast the number of characters can response in one second.

Typematic Delay (Msec): The number selected indicates the time period between two identical keys appear.

Security Option: Choose Setup or System. If system is selected, the password should be set.

PCI/VGA Palette Snoop: Select Disabled or Enabled. If Enabled the MPEG Card can synchronised with PCI/VGA.

OS Select For DRAM > 64MB: This item allows you to access the memory that over 64MB is OS/2. The choice: Non-OS2, OS2.

Video BIOS Shadow: ROM Shadow copies Video BIOS code from slower ROM to faster RAM. Video BIOS can then execute from RAM.

C8000-CFFFF Shadow: If enabled and BIOS is present in this segment, then the BIOS is shadowed.

D0000-DFFFF Shadow: If enabled and BIOS is present in this segment, then the BIOS is shadowed.

4.4 CHIPSET FEATURES SETUP

The Advanced Chipset Setup option is used to change the values of the chipset registers. These registers control most of the system options in the computer.

Note: Change these Settings only if user is familiar with the Chipset.

ROM PCI/ISA BIOS (2A59ID19)
 CHIPSET FEATURES SETUP
 AWARD SOFTWARE, INC.

Auto Configuration	: Enabled	
DRAM Timing	: 60 ns	
System BIOS Cacheable	: Disabled	
Video BIOS Cacheable	: Disabled	
8 Bit I/O Recovery Time	: NA	
16 Bit I/O Recovery Time	: NA	
Memory Hole At 15M-16M	: Disabled	
PCI Passive Release	: Disabled	
PCI Delayed Transaction	: Disabled	
		ESC: Quit ↑ ↓ → ←: Select Item F1: Help PU/PD/+/-: Modify F5: Old Values (Shift)F2: Color F7: Load Setup Defaults

Fig. 19 Chipset Feature Setup Menu

A short description of the screen items follows:

Auto Configuration: Pre-defined values for DRAM, cache, timing according to CPU type & system clock. Choose Enabled or Disabled.

DRAM Timing: Choose 60ns or 70ns according to the DRAM SIMM Module on the motherboard.

System BIOS Cacheable: Choose Enabled or Disabled. "Enabled" allows system BIOS be cacheable.

Video BIOS Cacheable: Choose Enabled or Disabled. "Enabled" allows Video BIOS to be cacheable.

8 Bit I/O Recovery Time: This item allows you to determine the recovery time allowed for 8 bit I/O. Choices are from NA, 1 to 8 CPU clocks. 1 clock is the default.

16 Bit I/O Recovery Time: This item allows you to determine the recovery time allowed for 16 bit I/O. Choices are from NA, 1 to 4 CPU clocks. 1 clock is the default.

Memory Hole At 15M-16M: In order to improve performance, certain space in memory can be reserved for ISA cards. This memory must be mapped into the memory space below 16MB. Disabled is the default.

4.5 POWER MANAGEMENT SETUP MENU

The Power Management Setup option is used to change the values of the chipset registers for system power management functions.

ROM PCI/ISA BIOS (2A59ID19)	
POWER MANAGEMENT SETUP	
AWARD SOFTWARE, INC.	
Power Management	: User Define
PM Control by APM	: No
Video Off Method	: Blank Screen
Video Off After	: N/A
Doze Mode	: Disabled
Standby Mode	: Disabled
Suspend Mode	: Disabled
HDD Power Down	: Disabled
Throttle Duty Cycle	: 12.5%
ZZ Active ins Suspend	: Disabled
VGA Active Monitor	: Disabled
** Break Event From Suspend **	
IRQ 8 Clock Event	: Disabled
** Reload Global Timer Events **	
IRQ (3-7, 9-15), NMI	: Disabled
Primary IDE 0	: Disabled
Primary IDE 1	: Disabled
Secondary IDE 1	: Disabled
Secondary IDE 2	: Disabled
Floppy Disk	: Disabled
Serial Port	: Disabled
Parallel Port	: Disabled
ESC: Quit ↑ ↓ → ←: Select Item	
F1: Help PU/PD/+/-: Modify	
F5: Old Values (Shift)F2: Color	
F7: Load Setup Defaults	

Fig. 20 Power Management Setup Menu

Note: Change these Settings only if user is familiar with the Chipset and system power management functions.

A short description of the screen items follows:

Power Management: Choose Disable, User Define, Max Saving or Min Saving. Disabled will disable all the power saving functions. User define means the power management time period of each I/O device can be programmed. Max and Min saving of each I/O device are list below.

	Max Saving	Min Saving
Doze Mode	1 Min	1 Hour
Standby Mode	1 Min	1 Hour
Suspend Mode	1 Min	1 Hour
HDD Power Down	1 Min	15 Min

Table 6

PM Control by APM: Choose Yes or No. Yes means the Power Management Function can be control by the MS APM software.

Video Off Method: Choose V/H SYNC+Blank, DPMS or Blank Screen. This is monitor Power Saving Method. V/H SYNC+Blank means turn off Vertical, Horizontal scanning and blank the screen. Blank Screen will blank the display screen. DPMS (Display Power Management System) can allow the System BIOS control the Display Card to turn off the Display.

Doze, Standby and Suspend Mode: Different level of Power Management stage.

HDD Power Down: To select the time period will turn the HDD off. Access the HDD again will take a few seconds for HDD to spin back to normal speed for data.

IRQx (Wake-up Event): When it is enabled, the system will monitor each ON event which also is "ON" on the right side device, once one of those device (IRQx) is triggered the system will go back from Doze, Standby Mode to normal state.

4.6 PnP/PCI CONFIGURATION

The PCI Configuration Setup option is used to configure the PCI add-on Cards on PCI Slots. Without proper setup the PCI Add-on Cards might not function properly.

ROM PCI/ISA BIOS (2A59ID19)
PNP/PCI CONFIGURATION
AWARD SOFTWARE, INC.

PNP OS Installed	: Yes	PCI IDE IRQ Map To	: PCI-AUTO
Resources Controlled By	: Manual	Primary IDE INT#	: A
Reset Configuration Data	: Disabled	Secondary IDE INT#	: B
IRQ-3 assigned to	: Legacy ISA	Used MEM Base Addr.	: C800
IRQ-4 assigned to	: Legacy ISA	Used MEM Length	: 8K
IRQ-5 assigned to	: PCI/ISA PnP		
IRQ-7 assigned to	: PCI/ISA PnP		
IRQ-9 assigned to	: PCI/ISA PnP		
IRQ-10 assigned to	: PCI/ISA PnP		
IRQ-11 assigned to	: PCI/ISA PnP		
IRQ-12 assigned to	: PCI/ISA PnP		
IRQ-14 assigned to	: PCI/ISA PnP		
IRQ-15 assigned to	: PCI/ISA PnP		
DMA-0 assigned to	: PCI/ISA PnP		
DMA-1 assigned to	: PCI/ISA PnP		
DMA-3 assigned to	: PCI/ISA PnP		
DMA-5 assigned to	: PCI/ISA PnP		
DMA-6 assigned to	: PCI/ISA PnP		
DMA-7 assigned to	: PCI/ISA PnP		
		ESC: Quit	↑ ↓ → ←: Select Item
		F1: Help	PU/PD/+/-: Modify
		F5: Old Values	(Shift)F2: Color
		F7: Load Setup Defaults	

Fig. 21 PnP/PCI Configuration Setup Menu

A short description of the screen items follows:

PNP OS Installed: Choose “Yes” to configure the BIOS that the Operating System installed support the Plug and Play standard.

Resources Controlled By: The Award Plug and Play BIOS has the capacity to automatically configure all of the boot and Plug and Play compatible devices. However, this capability means absolutely nothing unless you are using a Plug and Play operating system such as Windows 95.

Reset Configuration Data: If enable this option, the BIOS will clear and reset the ESCD after hardware reset.

IRQ3/4/5/7/9/10/11/12/14/15, DMA0/1/3/5/6/7 assigned to: This item allows you to determine the IRQ/DMA assigned to the ISA bus and is not available to any PCI slot. Choices are Legacy ISA and PCI/ISA PnP.

PCI IRQ Active By: Choose Level or Edge. The default settings is Level.

PCI IDE IRQ Map To: Choose PCI-AUTO, PCI-SLOT1, PCI-SLOT2, PCI-SLOT3, ISA. The default setting is PCI-AUTO.

Used MEM Base Addr/Used MEM Length: These items will be shown only when “Resources Controlled By” option is set to “Manual”. They are used to reserve the memory space for the memory installed on the ISA card in the specified memory segment (such as some network card). The available options for “Used Mem Base Addr” are “N/A”, “C800”, “CC00”, “D000”, “D400”, “D800” and “DC00”, which is used to select the base memory address of the ISA card used. With the “Used Mem Base Addr” is selected, the size of the memory installed on ISA card is chosen by “Used Mem Length”: “8K”, “16K”, “32K” or “64K”.

4.7 INTEGRATED PERIPHERALS SETUP MENU

The setup option is need to change the values of the integrated IDE and the I/O chipset register for I/O functions.

ROM PCI/ISA BIOS (2A59ID19)
INTEGRATED PERIPHERALS
AWARD SOFTWARE, INC.

IDE HDD Block Mode	: Disabled	ECP Mode Use DMA	: 1
IDE Primary Master PIO	: Auto	Parallel Port EPP Type	: EPP1.9
IDE Primary Slave PIO	: Auto		
IDE Secondary Master PIO	: Auto		
IDE Secondary Slave PIO	: Auto		
IDE Primary Master UDMA	: Disabled		
IDE Primary Slave UDMA	: Disabled		
IDE Secondary Master UDMA	: Disabled		
IDE Secondary Slave UDMA	: Disabled		
On-Chip Primary PCI IDE	: Disabled		
On-Chip Secondary PCI IDE	: Disabled		
Onboard FDD Controller	: Enabled		
Onboard Serial Port 1	: 3F8/IRQ4		
Onboard Serial Port 2	: 3F8/IRQ4		
UART 2 Mode	: HPSIR		
IR Function Duplex	: Full	ESC: Quit	↑↓ → ←: Select Item
RxD, TxD Active	: Hi, Hi	F1: Help	PU/PD/+/-: Modify
Onboard Parallel Port	: 3BC/IRQ7	F5: Old Values	(Shift)F2: Color
Onboard Parallel Mode	: ECP/EPP	F7: Load Setup Defaults	

Fig. 22 Integrated Peripherals Menu

A short description of the screen items follows:

IDE HDD Block Mode: This allows your hard controller to use the fast block mode to transfer data to and from your hard disk drive (HDD). Enabled is the default.

IDE PIO: PIO means Programmed Input/Output. Rather than have the BIOS issue a series of commands to effect a transfer to or from the disk drive, PIO allows the BIOS to tell the controller what it wants and then let the controller and the CPU perform the complete task by themselves. This simpler and more efficient (and faster).

Your system supports five modes, numbered from 0 (default) to 4, which primarily differ in timing. When Auto is selected, the BIOS will select the best available mode.

IDE UDMA: UDMA means Ultra DMA Mode. When a Ultra DMA Device is connected to the IDE connectors, set these options enabled.

On-Chip Primary PCI IDE: This setup item allows you either to enable or disable the primary controller. You might choose to disable the controller if you were to add a higher performance or specialized controller.

On-Chip Secondary PCI IDE: This setup item you either to enable or disable the secondary controller. You might choose to disable the controller if you were to add a higher performance or specialized controller. Enabled is the default.

Onboard FDC Controller: Choose Enabled or Disabled. "Enabled" allows onboard Floppy Drive Controller to be functioned, otherwise the users should use other sources.

Onboard Serial Port 1: Choose None or from COM1, COM3, COM4 with different I/O Address. While choosing proper I/O Address, be sure not to cause Address conflict with other I/O devices.

Onboard Serial Port 2: Choose None or from COM1, COM2, COM3, COM4 with different I/O Address. While choosing proper I/O Address, be sure not to cause Address conflict with other I/O devices.

UART 2 Mode: Choose Standard, ASKIR and HPSIR for IrDA serial interface.

IR Function Duplex: This item will be shown only when **UART 2 Mode** is selected to ASKIR or HPSIR. The available options are “Full” and “Half”. It is used to choose the IR function working in full duplex mode or half duplex mode correspondingly.

RxD, TxD Active: This item will be shown only when **UART 2 Mode** is selected to ASKIR or HPSIR. The available options are “Hi, Hi”, “Hi, Lo”, “Lo, Hi” and “Lo, Lo”. It is used to configure the logic level of Receive and Transmit signal in IrDA interface.

Onboard Parallel Port: Choose None or with four different I/O Address and corresponding IRQx. While choosing proper I/O Address, be sure not to cause Address conflict with other I/O devices.

Onboard Parallel Mode: Choose SPP, EPP/SPP, ECP, ECP/EPP Mode. Make proper selection with the attached printer port device.

ECP Mode Use DMA: When you choose the ECP mode, you can select DMA 1/ DMA 3 for it.

Parallel Port EPP Type: Choose EPP1.7 or EPP1.9.

4.8 LOAD SETUP DEFAULTS MENU

This Main Menu item uses the default setup values. Use this option as a diagnostic aid if the system behaves erratically. Choose this item and the following message appears:

"Load SETUP Defaults (Y/N)? N"

To use the Power-On defaults, change the prompt to "Y" and press <Enter>.

4.9 SUPERVISOR PASSWORD

Two level of password is supported. Depending on the setting of the "Security Option" in the "BIOS FEATURES SETUP", the system BIOS will ask for password every time booting up the System or entering BIOS Setup. With the supervisor password, both the system booting and BIOS setup changing is allowed.

This main menu item lets the user to set up the Supervisor Password.

Change the password as follows:

1. Choose "PASSWORD SETTING" in the Main Menu and press <Enter>. The following message appears:

"ENTER PASSWORD:"

2. Enter the Password and press <Enter>. The following message appears:

"CONFIRM PASSWORD:"

Important: Keep a safe record of the new password. If forget or lose the password, the only way to access the system is to disconnect the CMOS batteries and then re-enter the password.

4.10 USER PASSWORD

With the user password, only booting up the system is accepted, but changing the BIOS setup is not allowed.

4.11 IDE HDD AUTO DETECTION

When users can not find the Hard Disk information, it is very helpful to use this option.

1. Choose this item and press <Enter>.
2. After couple seconds, the screen will appear the Hard Disk information and following message:

"SELECT PRIMARY MASTER OPTION(N=SKIP): N"

3. Enter Y or N to confirm the acceptance then enter.
4. The process will repeat for Primary Slave, Secondary Master and Secondary Slave Hard Disks.

4.12 SCSI HARD DISK INSTALLATION

In Standard CMOS Setup Utility, select hard disk type to "Not Installed". In Advanced CMOS Setup Utility, Disable "Adapter ROM Shadow DC00". On the SCSI Controller card, set the jumpers which configure the SCSI card BIOS segment address located at DC00 or DE00. Format the SCSI disk by the Formatter provided in the SCSI BIOS.

4.13 SAVE & EXIT SETUP MENU

When you select this function, the following message will appear at the centre of the screen to assist you to Save data to CMOS and Exit the Setup.

Save to CMOS and Exit (Y/N)?

4.14 EXIT WITHOUT SAVING MENU

When you select this function, the following message will appear at the centre of the screen to assist you to Abandon all Data and Exit Setup.

Quit Without Saving (Y/N)?

This page is blank

This page is blank

This page is blank