



# ZOTAC<sup>®</sup> Motherboard



User's Manual



**NFORCE 610i-ITX**



**NFORCE 630i-ITX**

INTEL SOCKET 775 - PCI EXPRESS

MOTHERBOARD



## Electronic Emission Notices

### **Federal Communications Commission (FCC) Statement**

This equipment has been tested and found to comply with the limits for a Class B digital device, pursuant to Part 15 of FCC Rules. These limits are designed to provide reasonable protection against harmful interference in a residential installation. This equipment generates, uses and can radiate radio frequency energy and, if not installed and used in accordance with instructions contained in this manual, may cause harmful interference to radio and television communications. However, there is no guarantee that interference will not occur in a particular installation.

If this equipment does cause harmful interference to radio or television reception, which can be determined by turning the equipment off and on, the user is encouraged to try to correct the interference by one or more of the following measures:

- REORIENT OR RELOCATE THE RECEIVING ANTENNA
- INCREASE THE SEPARATION BETWEEN THE EQUIPMENT AND THE RECEIVER
- CONNECT THE EQUIPMENT INTO AN OUTLET ON A CIRCUIT DIFFERENT FROM THAT OF THE RECEIVER
- CONSULT THE DEALER OR AN EXPERIENCED AUDIO/TELEVISION TECHNICIAN

### **NOTE:**

Connecting this device to peripheral devices that do not comply with Class B requirements, or using an unshielded peripheral data cable, could also result in harmful interference to radio or television reception.

The user is cautioned that any changes or modifications not expressly approved by the party responsible for compliance could void the user's authority to operate this equipment.

To ensure that the use of this product does not contribute to interference, it is necessary to use shielded I/O cables.

### **Copyright**

This manual is copyrighted with all rights reserved. No portion of this manual may be copied or reproduced by any means.

While every precaution has been taken in the preparation of this manual, no responsibility for errors or omissions is assumed. Neither is any liability assumed for damages resulting from the use of the information contained herein.

### **Trademarks**

All brand names, logos and registered trademarks mentioned are property of their respective owners.

## Table of Contents

<b>Motherboard Specifications</b>	4
<b>Motherboard Layout</b>	5
<b>Hardware Installation</b>	7
Safety Instructions	7
<b>Preparing the Motherboard</b>	8
Installing the CPU	8
Installing the CPU Fan	9
Installing Memory DIMMs	9
Installing the Motherboard	10
Installing the I/O Shield	10
<b>Connecting Cables and Setting Switches</b>	11
20-pin ATX Power (PW1)	12
4-pin ATX 12V Power (PW2)	12
SPDIFOut Header(optional)	13
SPK Connector	13
Front Panel Header	14
USB Headers	15
Serial Port Connector-COM	15
Audio	16
Connecting Serial ATA Cables(optional)	17
Fan Connections	17
Expansion Slots	18
PCI Express x1 Slots(optional)	18
Jumper Settings	19
<b>Configuring the BIOS</b>	20
Enter BIOS Setup	20
<b>Main Menu</b>	21
<b>Advanced Menu</b>	22
<b>Boot Menu</b>	24
<b>Chipset Menu</b>	25
<b>PC Health</b>	26
<b>Exit Menu</b>	26
<b>Installing Drivers and Software</b>	28
<b>Drivers Installation</b>	28
<b>REALTEK HD AUDIO DRIVER SETUP</b>	31
Getting Started	31
Sound Effect	31

---

Environment Simulation	31
Equalizer Selection	31
Frequently Used Equalizer Setting	32
Karaoke Mode	32
Mixer	32
Playback control	33
Recording control	33
Audio I/O	34
Speaker Configuration	35
Connector Settings	35
S/PDIF	36
Speaker Calibration	36
Microphone	37
Noise Suppression	37
Beam Forming	37
Acoustic Echo Cancellation	37
Audio Demo	38
Information	38
<b>SATA RAID User Manual</b>	<b>39</b>
Setting up the BIOS	39
Entering the RAID BIOS Setup	40
Installing the RAID Drives	41

---



## **Motherboard Specifications**

### **Chipset**

NVIDIA MCP73 Series

### **Size**

Mini-ITX form factor of 170mm x 170mm

### **Microprocessor support**

Intel LGA 775 Celeron®, Pentium® 4, Pentium® D, Core™ 2 Series

### **Operating systems:**

Supports Windows XP 32 bit/64 bit and Windows Vista 32 bit/64 bit

### **System Memory support**

Supports DDRII 533/667(DDRII 800 for NForce 630i series). Supports up to 4 GB DDRII memory.

### **USB 2.0 Ports**

- ❖ Supports hot plug and play
- ❖ Eight USB 2.0 ports (six rear panel ports, two from onboard USB headers) (For NForce 610i series)
- ❖ Ten USB 2.0 ports (six rear panel ports, four from onboard USB headers) (For NForce 630i series)
- ❖ Supports wake-up from S3
- ❖ Supports USB 2.0 protocol up to 480 Mbps transmission rate

### **Onboard Serial ATA II**

- ❖ Independent DMA operation on four ports
- ❖ Data transfer rates of 3 Gb/s

### **Onboard LAN**

- ❖ LAN interface built-in onboard
- ❖ Supports 10/100 Mbps Ethernet
- ❖ Supports 1000 Mbps Ethernet (For NForce 630i series)

### **Onboard Audio (Optional)**

- ❖ Azalia High-Definition audio
- ❖ Supports 6-channel
- ❖ Supports Jack-Sensing function

### **Green Function**

- ❖ Supports ACPI (Advanced Configuration and Power Interface)
- ❖ RTC timer to power-on the system
- ❖ AC power failure recovery
- ❖ Supports suspend to RAM (STR)

### **Onboard Graphics support**

- ❖ Integrated 300 MHz DAC for external desktop display

### **Expansion Slots**

- ❖ One PCI Express x1 slot (Optional)

# Motherboard Layout

Figure 1 shows the motherboard and Figure 2 shows the back panel connectors.

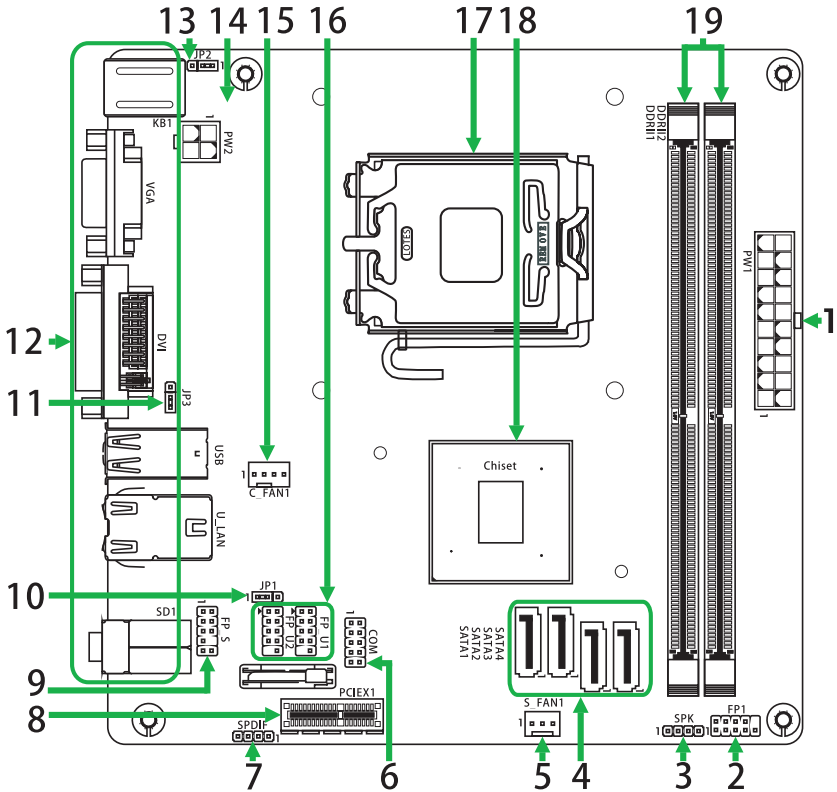
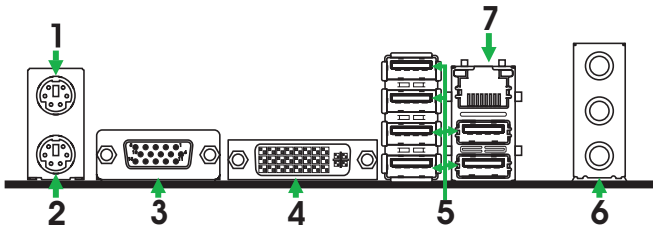

Figure 1. Board Layout

- |     |                                |     |                                      |
|-----|--------------------------------|-----|--------------------------------------|
| 1.  | 20-pin ATX Power Connector     | 11. | USB Power Select Jumper              |
| 2.  | Front Panel Header             | 12. | Backpanel connectors                 |
| 3.  | SPK Header                     | 13. | PS/2 port 5V standby selection Power |
| 4.  | Serial-ATA (SATA) Connectors   | 14. | 4-pin ATX_12V power connector        |
| 5.  | SYS Fan connector              | 15. | CPU Fan connector                    |
| 6.  | COM Header                     | 16. | USB Header                           |
| 7.  | SPDIF-OUT Header (Optional)    | 17. | CPU socket                           |
| 8.  | PCI Express x1 slot (Optional) | 18. | Chipset                              |
| 9.  | Front Panel Audio Header       | 19. | DDRII DIMM Sockets                   |
| 10. | Clear CMOS Jumper              |     |                                      |

Figure 2: Backpanel connectors



- 1. PS/2 Mouse Port
- 2. PS/2 Keyboard Port
- 3. VGA Connector
- 4. DVI Connector (optional for NForce630i-ITX)
- 5. USB Connectors

6. Port	2-Channel	4-Channel	6-Channel
Blue	Line-In	Rear Speaker Out	Rear Speaker Out
Green	Line-Out	Front Speaker Out	Front Speaker Out
Pink	Mic In	Mic In	Center/Subwoofer

7. LAN Connector

Lan Port with LEDs to indicate status.

- Yellow/Light Up/Blink = 10 Mbps/Link/Activity
- Yellow and Green/Light Up/Blink = 100 Mbps/link/Activity

## Hardware Installation

This section will guide you through the installation of the motherboard. The topics covered in this section are:

- Preparing the motherboard
  - ❖ Installing the CPU
  - ❖ Installing the CPU fan
  - ❖ Installing the memory

- Installing the motherboard

- Connecting cables and setting switches

### Safety Instructions

To reduce the risk of fire, electric shock, and injury, always follow basic safety precautions.

Remember to remove power from your computer by disconnecting the AC main source before removing or installing any equipment from/to the computer chassis.

## Preparing the Motherboard

The motherboard shipped in the box does not contain a CPU and memory. You need to purchase these to complete this installation.

### Installing the CPU

Be very careful when handling the CPU. Make sure not to bend or break any pins on the back. Hold the processor only by the edges and do not touch the bottom of the processor.

Use the following procedure to install the CPU onto the motherboard.

1. Unhook the socket lever by pushing down and away from the socket.
2. Lift the load plate. There is a protective socket cover on the load plate to protect the socket when there is no CPU installed.
3. Remove the protective socket cover from the load plate.
4. Remove the processor from its protective cover, making sure you hold it only by the edges. It is a good idea to save the cover so that whenever you remove the CPU, you have a safe place to store it.
5. Align the notches in the processor with the notches on the socket.
6. Lower the processor straight down into the socket with out tilting or sliding it into the socket.

**Note:** *Make sure the CPU is fully seated and level in the socket.*

7. Close the load plate over the CPU and press down while you close and engage the socket lever.

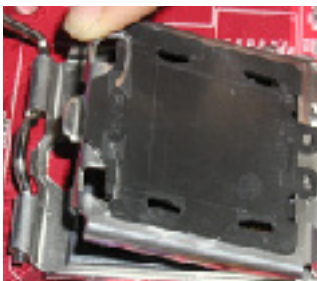

## Installing the CPU Fan

There are many different fan types that can be used with this motherboard. Follow the instruction that came with your fan assembly. Be sure that the fan orientation is correct for your chassis type and your fan assembly.

## Installing Memory DIMMs

Your new motherboard has two 1.8V 240-pin slots for DDR2 memory. These slots support 256 Mb, 512 Mb, 1Gb and 2Gb DDR2 technologies. There must be at least one memory bank populated to ensure normal operation. Use the following the recommendations for installing memory. (See Figure 1 on page 5 for the location of the memory slots.)

- One DIMM:** Install into slot 1 or 2. You can install the DIMM into any slot, however, slot 1 is preferred.
- Two DIMMs:** Install into both slots 1 and slot 2.

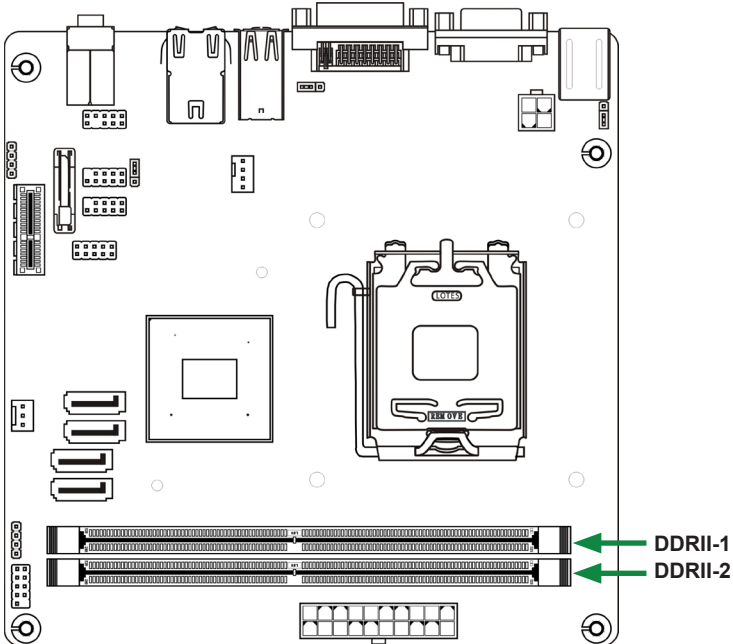

Use the following procedure to install memory DIMMs into the slots on the motherboard. Note that there is only one gap near the center of the DIMM slot. This slot matches the slot on the memory DIMM to ensure the component is installed properly.

1. Unlock a DIMM slot by pressing the module clips outward.
2. Align the memory module to the DIMM slot, and insert the module vertically into the DIMM slot. The plastic clips at both sides of the DIMM slot automatically lock the DIMM into the connector.

## **Installing the Motherboard**

The sequence of installing the motherboard into the chassis depends on the chassis you are using and if you are replacing an existing motherboard or working with an empty chassis. Determine if it would be easier to make all the connections prior to this step or to secure the motherboard and then make all the connections. It is normally easier to secure the motherboard first.

Use the following procedure to install the I/O shield and secure the motherboard into the chassis.

**Note:** *Be sure that the CPU fan assembly has enough clearance for the chassis covers to lock into place and for the expansion cards. Also make sure the CPU Fan assembly is aligned with the vents on the covers.*

## **Installing the I/O Shield**

The motherboard kit comes with an I/O shield that is used to block radio frequency transmissions, protects internal components from dust and foreign objects, and promotes correct airflow within the chassis.

Before installing the motherboard, install the I/O shield from the **inside** of the chassis. Press the I/O shield into place and make sure it fits securely. If the I/O shield does not fit into the chassis, you would need to obtain the proper size from the chassis supplier.

## Connecting Cables and Setting Switches

This section takes you through all the connections and switch settings necessary on the motherboard. This will include:

- Power Connections
  - ❖ 20-pin ATX power (**PW1**)
  - ❖ 4-pin ATX 12V power (**PW2**)
  
- Internal Headers
  - ❖ SPDIF Out Header (Optional)
  - ❖ SPK Connector
  - ❖ Front panel Header
  - ❖ USB Headers
  - ❖ Serial Port Connector-COM
  - ❖ Audio
  
- Serial ATA II
  
- Chassis Fans
  
- Expansion slots
  
- Jumper settings

***See Figure 1 to locate the connectors and jumpers referenced in the following procedure.***



## 20-pin ATX Power (PW1)

**PW1** is the main power supply connector located along the edge of the board next to the DIMM slots. Make sure that the power supply cable and pins are properly aligned with the connector on the motherboard. Firmly plug the power supply cable into the connector and make sure it is secure.

**Table 1. PW1 Pin Assignments**

### Connector

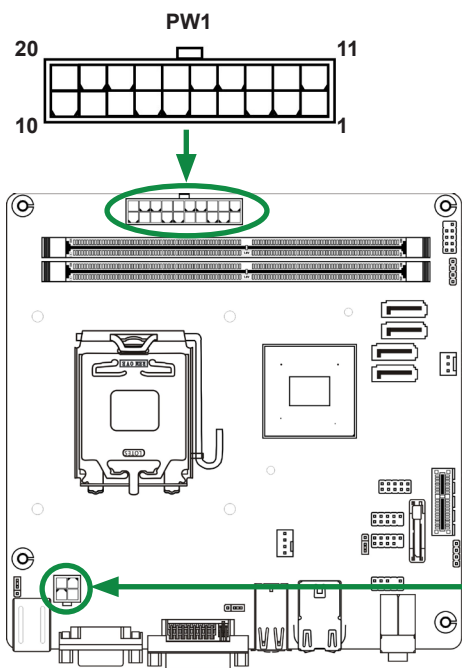

Pin	Signal	Pin	Signal
1	+3.3V	11	+3.3V
2	+3.3V	12	-12V
3	GND	13	GND
4	+5V	14	PS_ON
5	GND	15	GND
6	+5V	16	GND
7	GND	17	GND
8	PWROK	18	-5V
9	+5V_AUX	19	+5V
10	+12V	20	+5V

## 4-pin ATX 12V Power (PW2)

**PW2**, the 4-pin ATX 12V power connection, is used to provide power to the CPU. Align the pins to the connector and press firmly until seated.

**PW2 - Pin Definition**

PIN	Assignment
1	GND
2	GND
3	+12V
4	+12V

## SPDIF Out Header (Optional)

This header provides a SPDIF (Sony/Philips Digital Interface) output to digital multimedia device through coaxial connector.

### CN7 - Pin Definition

PIN	Assignment
1	SPDIF-out
2	+3.3V
3	NC
4	GND

## SPK Connector

### SPK - Pin Definition

PIN	Assignment
1	VCC
2	NC
3	NC
4	SPK-

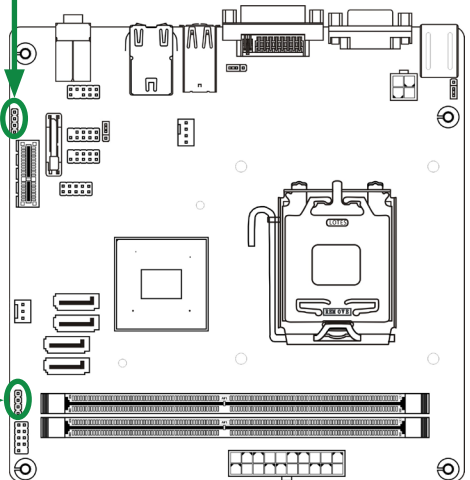

## Front Panel Header

The front panel header on this motherboard is one connector used to connect the following four cables:

### PWRLED

Attach the front panel power LED cable to these two pins of the connector. The Power LED indicates the system's status.

## Front Panel Header Pin Definition

	FP1		
HDD_LED+	1	2	PW_LED+
HDD_LED-	3	4	PW_LED-
GND	5	6	PWR_SW
RESET	7	8	GND
NC	9	10	KEY

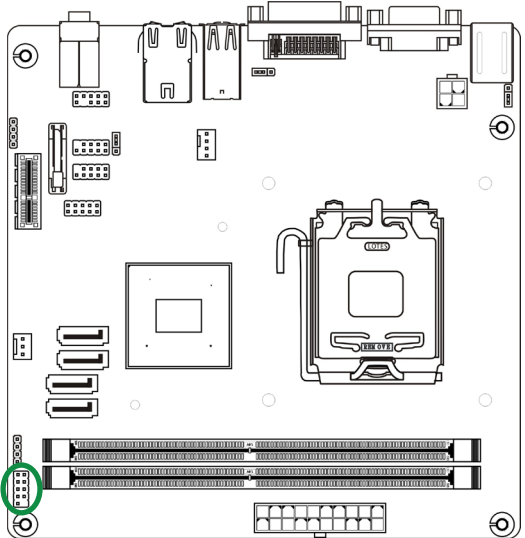

**Note:** Some chassis do not have all four cables. Be sure to match the name on the connectors to the corresponding pins.

### PWR SW

Attach the power button cable from the case to these two pins. Pressing the power button on the front panel turns the system on and off rather than using the power supply button.

### HDD LED

Attach the hard disk drive indicator **LED** cable to these two pins. The HDD indicator **LED** indicates the activity status of the hard disks.

### RST SW

Attach the Reset switch cable from the front panel of the case to these two pins. The system restarts when the **RESET** switch is pressed.

## USB Headers

This motherboard contains six USB 2.0 ports that are exposed on the rear panel of the chassis (Figure 2). The motherboard also contains one 10-pin internal header (for NFORCE 610i series) or two 10-pin internal headers (for NFORCE 630i series) onboard.

**Note.** Secure the bracket to either the front or rear panel of your chassis (not all chassis are equipped with the front panel option).

### USB - Pin Definition

PIN	Assignment
1	VCC
2	VCC
3	USBP0-
4	USBP1-
5	USBP0+
6	USBP1+
7	GND
8	GND
9	KEY
10	OC#

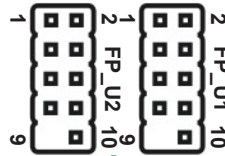

## Serial Port Connector - COM

### COM - Pin Definition

PIN	Assignment
1	DCD
2	RXD
3	TXD
4	DTR
5	GND
6	DSR
7	RTS
8	CTS
9	RI
10	NC

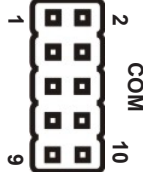
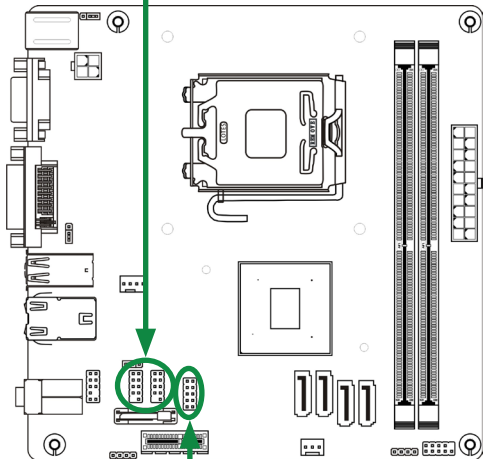

## Audio

The audio connector supports HD audio standard and provides two kinds of audio output choices: the Front Audio, the Rear Audio. The front Audio supports re-tasking function.

### FP-S Pin Definition

PIN	Assignment
1	MIC2(L)
2	GND
3	MIC(R)
4	-ACZ-DET
5	Front Audio(R)
6	Reserved
7	FAVDIO - JD
8	Key (No pin)
9	Front Audio(L)
10	Reserved

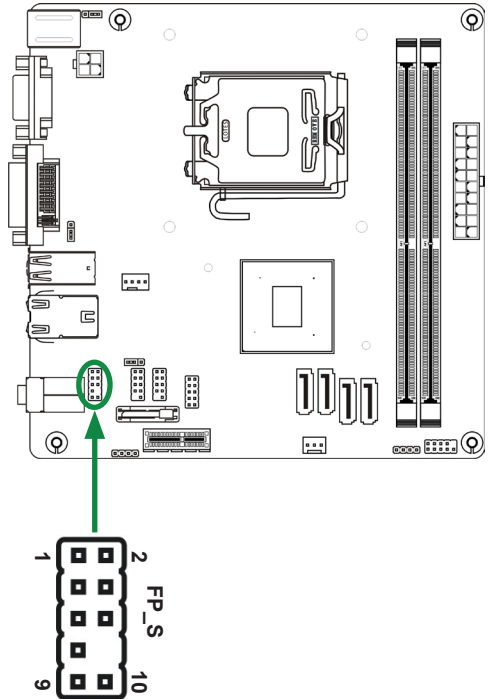

### Note:

In order to utilize the front audio header, your chassis must have front audio connector. Also please make sure the pin assignment on the cable is the same as the pin assignment on the mainboard header. To find out if the chassis you are buying supports a front audio connector, please contract your dealer.

## Connecting Serial ATA Cables

The Serial ATA II connector is used to connect the Serial ATA II device to the motherboard. These connectors support the thin Serial ATA II cables for primary storage devices. The current Serial ATA II interface allows up to 3 Gb/s data transfer rate. There are four serial ATA connectors on the motherboard that support AHCI and RAID configurations.

### SATA1~SATA4 Pin Definition

PIN	SIGNAL
1	GND
2	TXP
3	TXN
4	GND
5	RXN
6	RXP
7	GND

### Fan Connections

There are two fan connections on the motherboard. The fan speed can be detected and viewed in the PC Health Status section of the CMOS Setup.

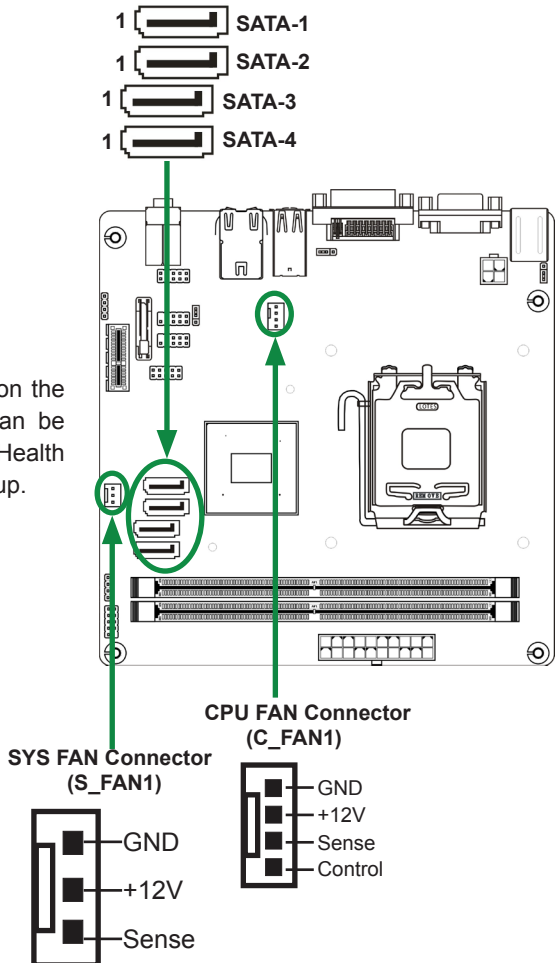

## Expansion Slots

The NVIDIA MCP73 motherboard contains one PCI Express x1 slot.

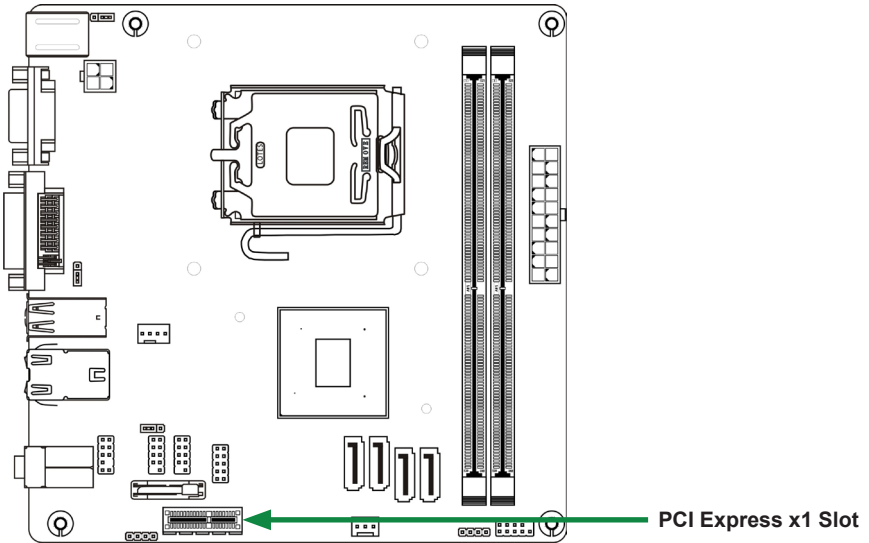





### **PCI Express x1 Slots\_PCIE2 (Optional)**

There is one PCI Express x1 slot that is designed to accommodate less bandwidth-intensive cards, such as a modem or LAN card. The PCI Express x1 slot provides 250 MB/sec bandwidth.





## Jumper Settings

This chapter explains how to configure the motherboard's hardware. Before using your computer, make sure all jumpers and DRAM modules are set correctly. Refer to this chapter whenever in doubt.





### JP1-CMOS Clear Jumper

JP1	Selection
1   1-2*	Normal*
1   2-3	CMOS Clear

### JP2-PS/2 Port 5V Standby Power Selection

JP2	Selection
1   1-2*	5V standby power input*
1   2-3	5V power input

### JP3-USB Power select

JP3	Selection
1   1-2*	5VSB*
1   2-3	5V

 Close  Open \* = Default setting.

If you want to clear the system configuration, use the JP1(Clear CMOS Jumper) to clear data

#### Notice:

1. Be sure to save the CMOS setting when exit the CMOS.
2. If the CPU is frequency multiplier locked, no CPU speed change will be seen even if the frequency multiplier setting in CMOS setup is changed.



## Configuring the BIOS

This section discusses how to change the system settings through the BIOS Setup menus. Detailed descriptions of the BIOS parameters are also provided.

### Enter BIOS Setup

The BIOS is the communication bridge between hardware and software. Correctly setting the BIOS parameters is critical to maintain optimal system performance.

Use the following procedure to verify/change BIOS settings.

1. Power on the computer.,
2. Press the **Del** key when the following message briefly displays at the bottom of the screen during the Power On Self Test (POST).

Pressing **Del** takes you to the BIOS Setup Utility.

**Note:** *It is strongly recommended that you do not change the default BIOS settings. Changing some settings could damage your computer.*

## Main Menu

This menu gives you an overview of the general system specifications. The BIOS automatically detects the items in this menu.

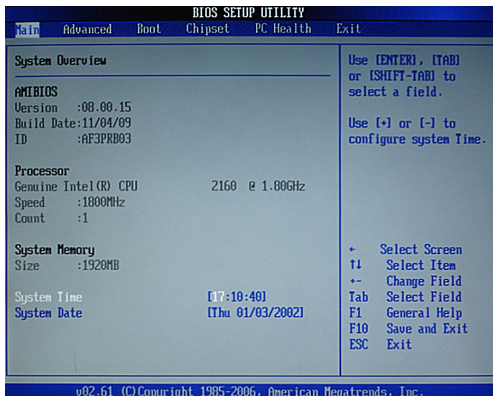

**Note:** Note that the data in gray is non-changeable, and the others are for selection.

- AMI BIOS**  
Displays the auto-detected BIOS information
- Processor**  
Display the auto-detected CPU specification
- System Memory**  
Displays the auto-detected system memory
- System time**  
Allows you to set the system time

## Advanced Menu

The Advanced menu items allow you to change the setting for the CPU and other system devices. Press <enter> to display the configuration options:

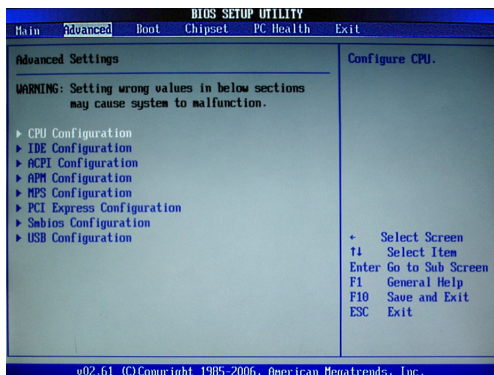

## CPU Configuration

The items in this menu show the CPU-related information that the BIOS automatically detects. Press <enter> to display the configuration options:

### Configure advanced CPU settings

Displays the auto-detected CPU information

### Max CPUID Value Limit

Allows you to determine whether to limit CPUID maximum value. Set this item to [Disable] Windows XP operating system; set this item to [Enable] for legacy operating system such as Windows NT4.0..

### Execute-Disable Bit Capability

This function enhances protection of your computer, reducing exposure to viruses and malicious buffer overflow attacks when working with its supporting software and system.

### Core Multi-Processing

Use this option to enable or disable Core Multi-Processing.

### PECI

Use this option to enable or disable PECI (Platform Environment Control Interface).

### Intel(R) SpeedStep(tm) tech

Use this option to enable or disable Intel® SpeedStep™ Technology.

## IDE Configuration

The items in this menu allow you to set or change the configurations for the IDE devices installed in the system. Press <enter> to display the configuration options:

### On-chip P-ATA Controller

This item allow you to enabled or disabled the PATA controller.

### On-chip S-ATA Controller

This item allow you to enabled or disabled the SATA controller.

### SATA Mode select

This item allow you to set the SATA to IDE/AHCI/RAID mode.

### Hard Disk Write Protect

This will be effective only if device is accessed through BIOS.

**IDE Detect Time Out**

The items allow you to select the time out value for detecting ATA/ATAPI devices.

 **ATA (PI) 80pin cable detection**

The items allow you to select the mechanism for detecting 80pin ATA(PI) cable.

**ACPI Configuration**

The items in this menu allow you to setting General ACPI configuration, Advanced ACPI Configuration and Chipset ACPI Configuration.

**APM Configuration**

These items allow you to configure Advanced Power Management.

**MPS Configuration**

The items in this menu allow you to configure MPS.

**PCI Express Configuration**

The items in this menu allow you to enable or disable PCI Express L0S and L1 link power states.

**Smbios Configuration**

SMBIOS SMI wrapper support for PnP Function 50h-54h.

**USB Configuration**

The items in this menu allow you to change the USB-related features. Press <enter> To display the configuration options:

 **Legacy USB Support**

Allows you to enable or disable support for USB devices on legacy operating systems.

 **USB 2.0 Controller Mode**

Allows you to configure the USB 2.0 controller in HiSpeed or Full Speed .

 **BIOS EHCI Hand-Off**

Allows you to enable support for operating systems without an EHCI hand-off feature.

## Boot Menu

The Boot menu items allow you to change the system boot options. Press <enter> to display the configuration options:

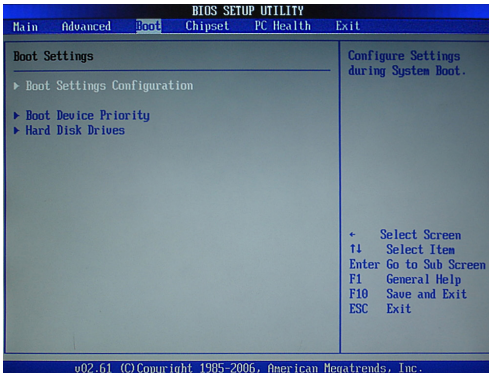

### Boot settings configuration

The items allow you to configure Boot settings. Press <enter> To display the configuration options:

#### Quick Boot

Enabling this item allows the BIOS to skip some power on self tests while booting to decrease the time needed to boot the system. When set to [Disabled], BIOS performs all the POST items.

#### Quiet Boot

When set to [Disabled], displays normal POST message. When set to [Enabled], displays OEM Logo instead of POST messages.

#### AddOn ROM Display Mode

Sets the display mode for option ROM.

#### Bootup Num-Lock

Allows you to select the power-on state for the NumLock.

#### PS/2 Mouse Support

Allows you to enable or disable support for PS/2 mouse.

#### Wait for 'F1' If Error

When set to [Enabled], the system waits for the F1 key to be pressed when error occurs.

#### Hit 'DEL' Message Display

When set to [Enabled], the system displays the message "press DEL to run setup" during POST.

#### Interrupt 19 Capture

When set to [Enabled], this function allows the option ROMs to trap interrupt 19.

### Boot Device Priority

The items allow you to specify the boot device priority sequence.

### Hard Disk Drives

This option allows you to specify the boot device from hard disk drives.

## Chipset Menu

The chipset menu items allow you to change the advanced chipset settings. Press <enter> to display the sub-menu:

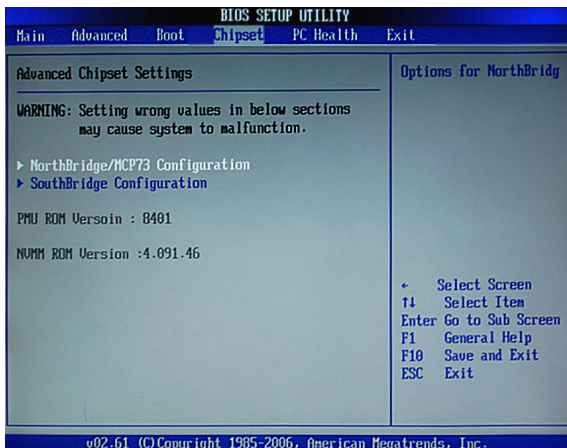

### NorthBridge/MCP73 Configuration

The items allow you to configure north bridge features, including Memory, Graphic, Video, and so on.

### SouthBridge Configuration

The items allow you to configure south bridge features, including USB, HDA, PCIE Port, Onboard Lan/1394, CPU GTL REF, and so on.

## PC Health Menu

The PC Health menu items allow you to monitor the parameters for critical voltages, temperatures and fan speeds. Press <enter> to display the sub-menu:

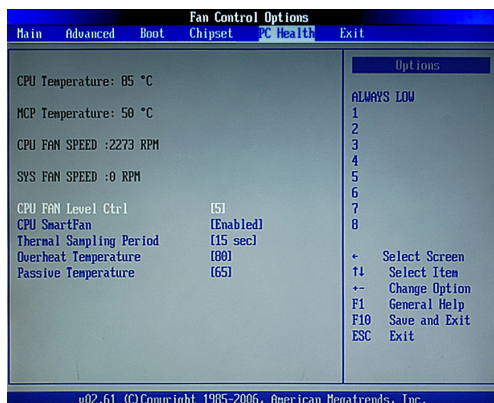

## CPU SmartFan

This item allows you to enable and disable the control of the CPU fan speed by changing the CPU temperature.

## Exit Menu

The exit menu items allow you to load the option or failsafe default values for the BIOS items, and save or discard your changes to the BIOS items. Press <enter> to display the sub-menu:

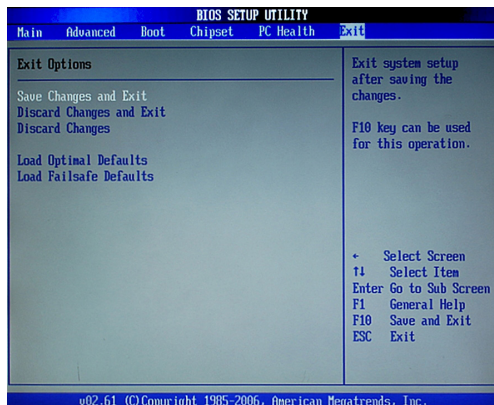

## Save Change and Exit

Once you are finished making your selections, choose this option from the Exit menu to ensure the values you selected are saved to the CMOS RAM. An onboard backup battery sustains the CMOS RAM so it stays on even when the PC is turned off. When you select this option, a confirmation window appears. Select OK to save change and exit.

## Discard Changes and Exit

Select this option only if you do not want to save the changes that you made to the setup program. If you made changes to fields other than system date, system time, and password, the BIOS asks for a confirmation before exiting.

## Discard Changes

This option allows you to discard the selections you made and restore the previously saved values. After selecting this option, a confirmation appears. Select Ok to discard any change and load the previously saved values.

## Load Optimal Defaults

This option allows you to load the default values for each of the parameters on the setup menus. When you select this option, a confirmation window appears. Select Ok to load default values. Select Exit and Save Change or make other changes before saving the values to the non-volatile RAM.

## Load Failsafe Defaults

This option has been set by the manufacturer and represents settings which provide the minimum requirements for your sys to operate.

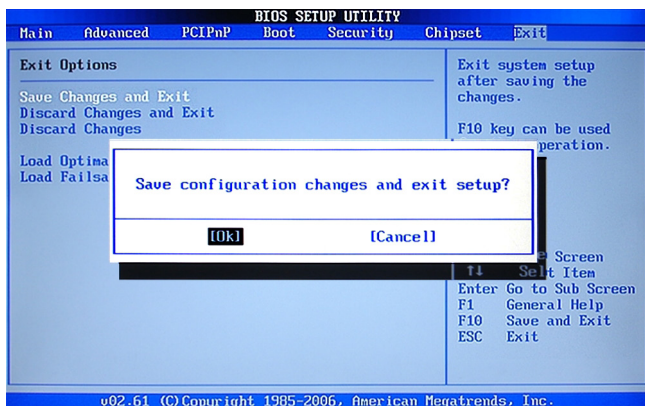



# Installing Drivers and Software

**Note:** *It is important to remember that before installing the driver CD that is shipped in the kit, you need to load your operating system. The motherboard supports Windows XP 32bit and 64bit and is Vista-capable.*

The kit comes with a CD that contains utility drivers and additional software.

## Drivers Installation

1. Insert the driver CD after loading your operating system. Waiting for one minute you can see below interface.

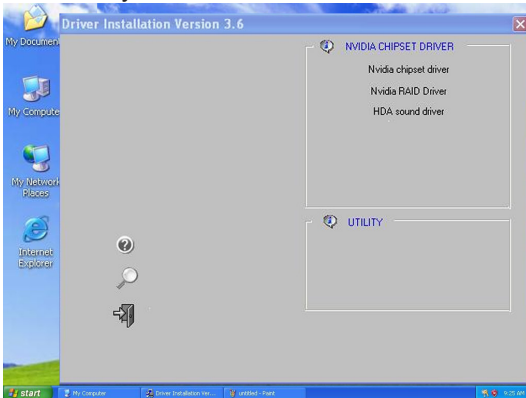

2. Follow the below steps to install driver.

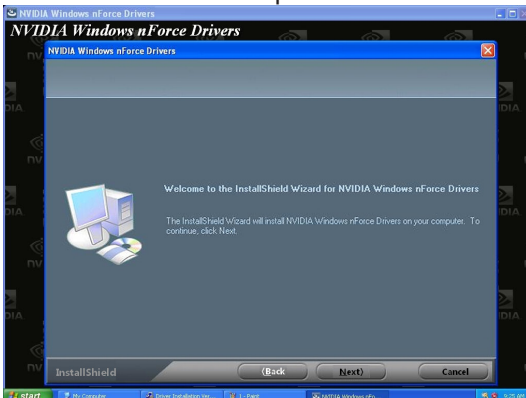

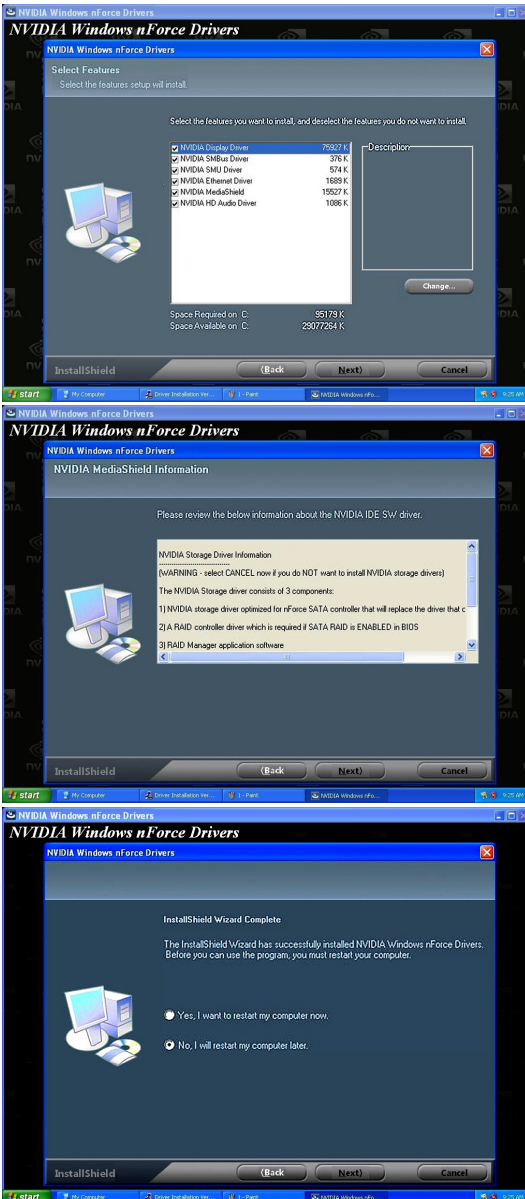

### 3. Follow the below for HDA sound driver installing.



### 4. At last, you can open below page that provides information about the hardware devices on this motherboard, and check whether finish your installation.

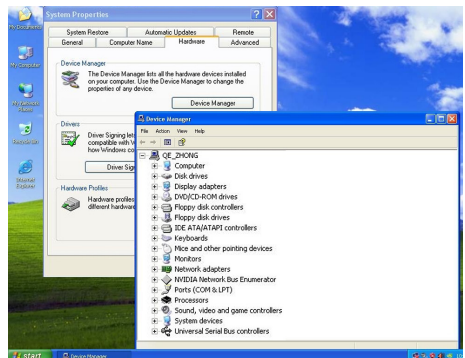

## Realtek HD Audio Driver Setup

### Getting Started

After Realtek HD Audio Driver being installed (insert the driver CD and follow the on-screen instructions), “Realtek HD Audio Manager” icon will show in System tray as below. Double click the icon and the control panel will appear:



### Sound Effect

After clicking on the “Sound Effect” tab, 3 sections “Environment”, “Equalizer” and “Karaoke” are available for selection.



### Environment Simulation

You will be able to enjoy different sound experience by pulling down the arrow, totally 23 kinds of sound effect will be shown for selection. Realtek HD Audio Sound Manager also provides five popular settings “Stone Corridor”, “Bathroom”, “Sewer pipe”, “Arena” and “Audio Corridor” for quick enjoyment.

### Equalizer Selection

The Equalizer section allows you to create your own preferred settings by utilizing this tool. In standard 10 bands of equalizer, ranging from 100Hz to 16KHz are available:

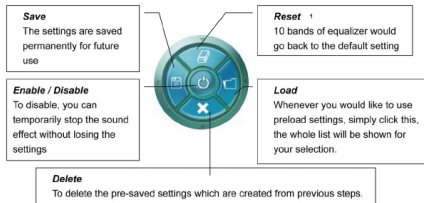

## Frequently Used Equalizer Setting

Realtek recognizes the needs that you might have. By leveraging our long experience at audio field, Realtek HD Audio Sound Manager provides you certain optimized equalizer settings that are frequently used for your quick enjoyment.

### How to Use

Other than the buttons “Pop” “Live” “Club” & “Rock” shown on the page, to pull down the arrow in “Others”, you will find more optimized settings available to you.

### Karaoke Mode

Karaoke mode brings Karaoke fun back home by simply using the music you usually play, Karaoke mode can help you eliminate the vocal of the song or adjust the key to accommodate your range.

### Vocal Cancellation

Single click on “Voice Cancellation”, the vocals of the songs will be erased, while the background music is still playing which lets you take over the vocal part.

### Key Adjustment

Using “Up / Down Arrow” to find a key which better fits your vocal range.

### Mixer

Realtek HD Audio Sound Manager integrates Microsoft’s “Volume Control” functions into the Mixer page. This gives you the advantage to you to create your favorite sound effect in one single tool.



## Playback control

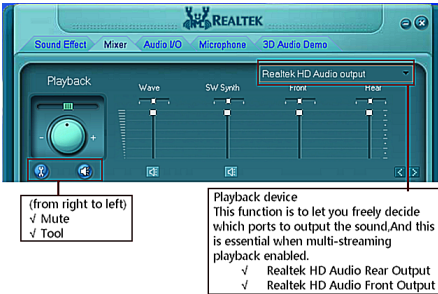

### Mute

You may choose to mute single or multiple volume controls or to completely mute sound output.

### Tool

#### ✓ Show the following volume control

This is to let you freely decide which volume control items to be displayed, total 13 items to be chosen.

#### ✓ Advanced controls

#### ✓ Enable playback multi-streaming

With this function, you will be able to have an audio chat with your friends via headphone (stream 1 from front panel) while still have music (stream 2 from back panel) playing. At any given period, you can have maximum 2 streams operating simultaneously.

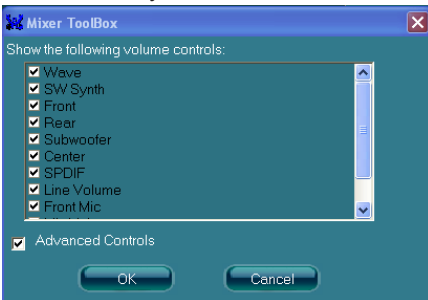

## Recording control

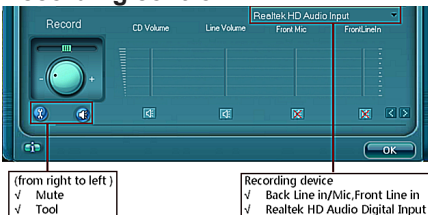

## Mute

You may choose to mute single or multiple volume controls or to completely mute sound input.

## Tool

- ✓ **Show the following volume controls**  
This is to let you freely decide which volume control items to be displayed.
- ✓ **Advanced controls.**  
Advanced control is a “Microphone Boost” icon.  
Once this item is checked, you will find “advanced” icon beside “Front Pink In” & “Mic Volume”. With this, the input signal into “Front Pink In” & “Mic Volume” will be strengthened.
- ✓ **Enable recording multi-streaming**  
At any given period, you can have maximum 2 streams operating simultaneously.

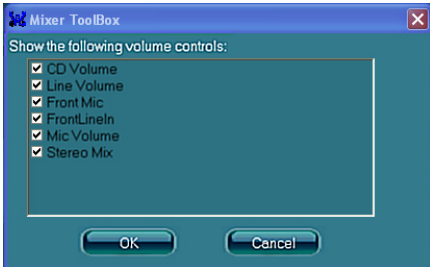

## Audio I/O

Realtek HD Audio Manager frees you from default speaker settings. Different from before, for each jack, they are not limited to perform certain functions. Instead, now each jack is able to be chosen to perform either output (i.e. playback) function or input (i.e. Recording) function, we call this “Retasking”.

Audio I/O aims to help you setting jacks as you wish. Moreover, other than blue to blue, pink to pink, the way that you used to do, Audio I/O would guide you to other ring jacks that can also serve as microphone/speaker/headphone.



## Speaker Configuration

**Step 1:** Plug in the device in any available jack.

**Step 2:** Dialogue “connected device” will pop up for your selection. Please select the device you are trying to plug in.

- \* If the device is being plugged into the correct jack, you will be able to find the icon beside the jack changed to the one that is same as your device.
- \* If not correct, Realtek HD Audio Manager will guide you to plug the device into the correct jack.

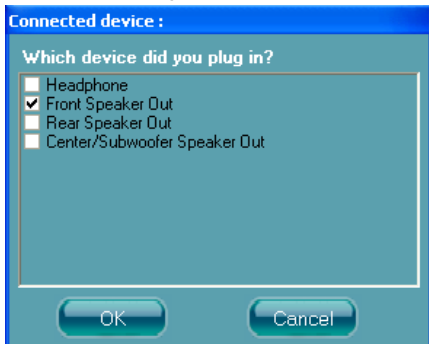

## Connector Settings

Click  to access connector settings

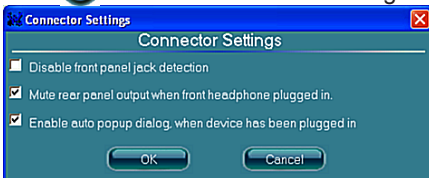

- √ **Mute rear panel when front headphone plugged in**  
Once this option is checked, when front headphone is plugged, the music that is playing from the back panel, will be stopped.
- √ **Disable front panel jack detection (option)**  
Did not find any function on front panel jacks?  
Please check if front jacks on your system are so-called AC'97 jacks. If so, please check this item to disable front panel jack detection.
- √ **Enable auto popup dialogue, when device has been plugged in.**  
Once this item checked, the dialog “Connected device” would automatically pop up when device plugged in.



## S/PDIF

Short for **Sony/Philips Digital Interface**, a standard audio file transfer format. S/PDIF allows the transfer of digital audio signals from one device to another without having to be converted first to an analog format. Maintaining the viability of a digital signal prevents the quality of the signal from degrading when it is converted to analog.

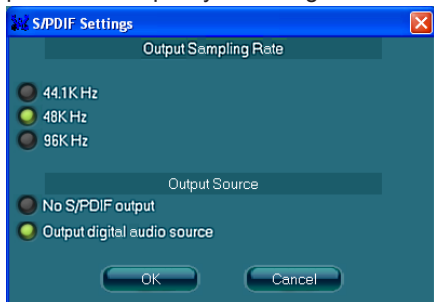

### ✓ Output Sampling Rate

- 44.1KHz: This is recommended while playing CD
- 48KHz: This is recommended while playing DVD or Dolby.
- 96KHz: This is recommended while playing DVD-Audio.

### ✓ Output Source

- Output digital audio source: The digital audio format (such as .wav, .mp3, .midi etc) will come out through S/PDIF-Out.

## Speaker Calibration

After you have successfully plugged in speakers and assigned to the right jacks, you are only one more step to go to enjoy the intended sound. We provide "Speaker Calibration" to help you check if the speakers are located in the correct position.



## Microphone

This page is designed to provide you better microphone / recording quality.

Below picture indicates both “Noise Suppression” & “Acoustic Echo Cancellation” are both enabled.



### Noise Suppression

If you feel that the background noise, especially the sound generated from the fan inside PC, is too loud? Try “Noise Suppression”, which allows you to cut off and suppress disturbing noise.

### Beam Forming

Also known as “directional recording”, this option lets you do the following: Once beam forming is enabled; only the sound from certain direction will be recorded. You will get the best quality if you chose 90° position, which we recommend you to use, this effectively means that you speak right into the microphone.

**Note:** A Stereo Microphone is required when using Beam Forming function.

### Acoustic Echo Cancellation

This function prevents playback sound from being recorded by microphone together with your sound. For example, you might have chance to use VOIP function through Internet with your friends. The voice of your friend will come out from speakers (playback). However, the voice of your friend might also be recorded into your microphone then go back to your friend through Internet. In that case, your friend will hear his/her own voice again. With AEC (Acoustic Echo Cancellation) enabled at your side, your friend can enjoy the benefit with less echo.

## Audio Demo

The section “3D Audio Demo” grants you another possibility to enjoy your sound. The Audio Demo allows you to listen to sound in an extraordinary way.



## Information

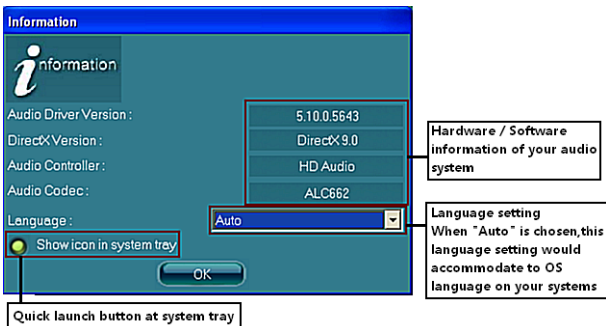

This section provides information about your current system audio device.

# SATA RAID User Manual

## Setting up the BIOS

1. Setting your computer, then press Delete to enter the Bios setup.  
Delete to enter the Bios setup.
2. Use the arrow keys to select Advanced menu. When enter the Advanced, use the arrow keys to select the Item "IDE Configuration".
3. Press Enter to display the IDE Configuration, then use the arrow keys to Select the item SATA mode select and set it RAID Mode.

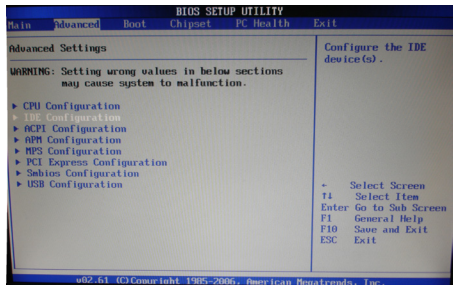

4. Use the arrow keys to Select the item nVidia RAID Setup.
5. Press enter to display the RAID Setup.

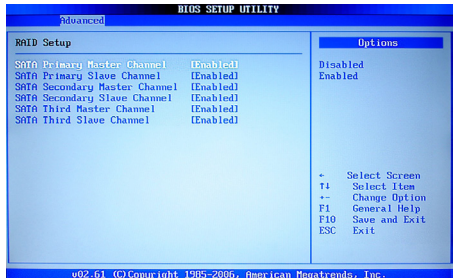
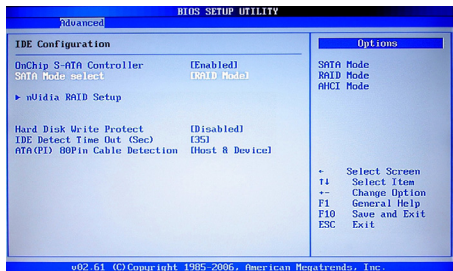

6. From the Raid Setup window, enable RAID, then enable the disks that you want to use as RAID disks.
7. Press F10 to save the configuration and exit. The PC reboots.
8. Enter the RAID BIOS Setup by pressing F10 when prompted, and proceed to set up the NVRAID BIOS as described in the next Section.

## Entering the RAID BIOS Setup

1. After rebooting your computer, wait until you see the RAID software prompt you to press F10.
2. The NVIDIA RAID Utility—Define a New Array window appears

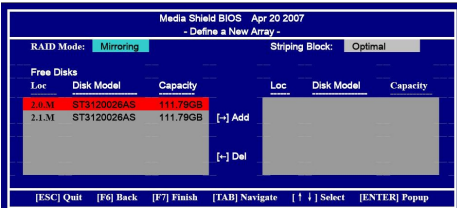

3. In the RAID Mode field, use the UP or Down ARROW key to select a RAID Mode. The supported RAID modes include Mirroring (RAID 1), Striping (RAID 0) and Stripe Mirroring (RAID 0+1), Spanning(JBOD) and RAID 5. The following is an example of RAID 0 array creation.
4. If RAID 0(Striping) is selected, you can manually set the striping block size. in the Stripping Block field, use the UP or DOWN ARROW key to set the Stripping Block size. The KB is standard unit of Stripping Block size. We recommend you leaving it to the default setting—Optimal(64k). The size range is from 4k to 128k.
5. Select the hard drivers which you wish to be included in the disk array. The Free Disks section displays the information about the currently installed SATA hard drives. Press the TAB key to move to the Free Disks section. Select the target hard drives using the UP or DOWN ARROW key and use the RIGHT ARROW key to add the hard drives to the Array Disks section.

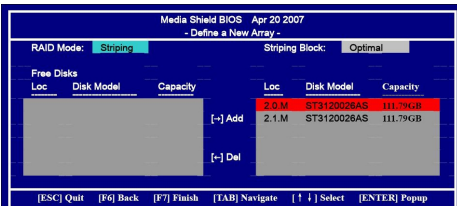

6. Press F7 after selecting the target hard disks. A message which says “Clear disk data?” will appear. If you are sure to clear the data in the selected hard drives, press Y. (If the hard drives contain previously created RAID array, you need to press Y to clear the data from the hard drives.)

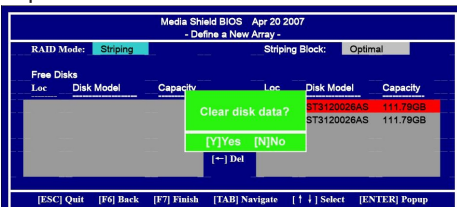

7. After that, then Array List screen displaying the RAID array you created will appear. If you want to set the disk array as boot device, use the UP or DOWN ARROW key to select the array and press B. The Boot section will show Yes.

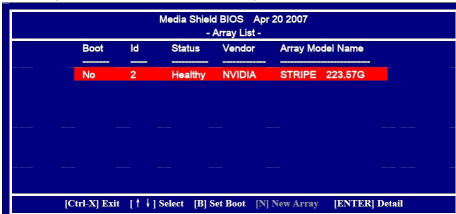

8. To read more information about the RAID array, press ENTER to enter the Array Detail screen, where you should see detailed information about RAID mode, disk block size, disk model name, and disk capacity, etc.

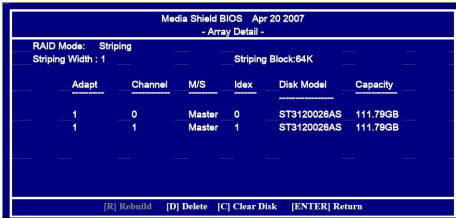

9. To delete the array, press D in the Array Detail screen. When the “Delete this array?” message appears, press Y to confirm or N to cancel. Press ENTER to return to the Array List screen. To exit the Nvidia RAID utility, press ESC in the main menu or Ctrl+X in the Array List screen. Now, you can proceed to install the SATA controller driver and operating system.

## Installing the RAID Drivers

1. After you complete the RAID BIOS setup, boot from the windowsXP CD. The Windows Setup program starts.



## 2. Press F6 and wait a few moments for the Windows Setup screen to appear.

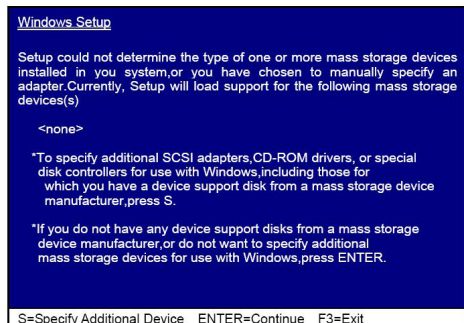

## 3. Specify the NVIDIA drivers.

### (1) Insert the floppy that has the RAID driver, press S, then press Enter.

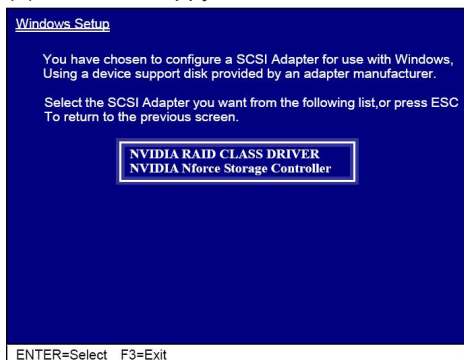

### (2) Select “NVIDIA RAID CLASS DRIVER” and then press Enter.

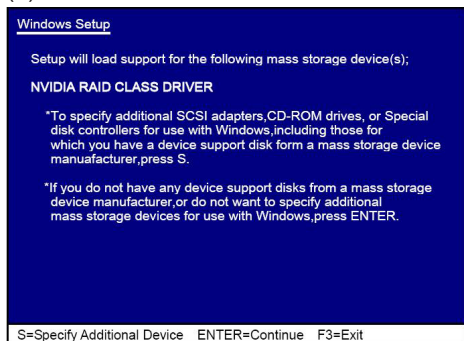

- (3) Press S again at the Specify Devices screen, then press Enter.
- (4) Select "NVIDIA Nforce Storage Controller" and then press Enter.

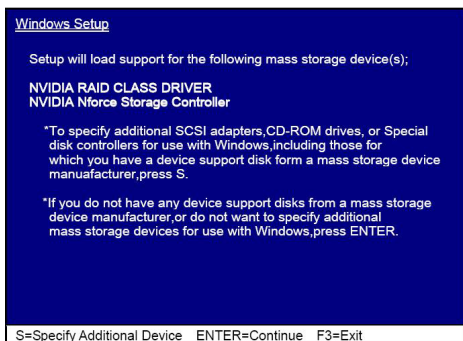

4. Press Enter to continue with Windows XP Installation.

Be sure to leave the floppy disk inserted in the floppy drive until the blue screen portion of Windows XP installation is completed, then take out the floppy.

5. Follow the instructions on how to install Windows XP.

During the GUI portion of the install you might be prompted to click Yes to install the RAID driver. Click Yes as many times as needed in order to finish the installation. This will not be an issue with a signed driver.

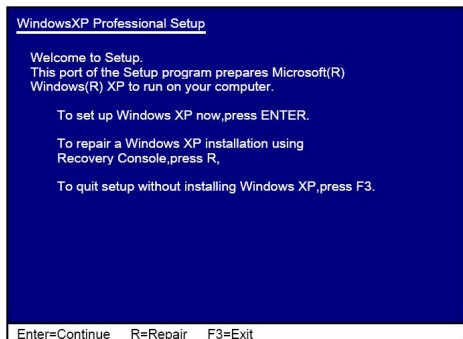





[www.zotac.com](http://www.zotac.com)



**RoHS**  
Compliant

