

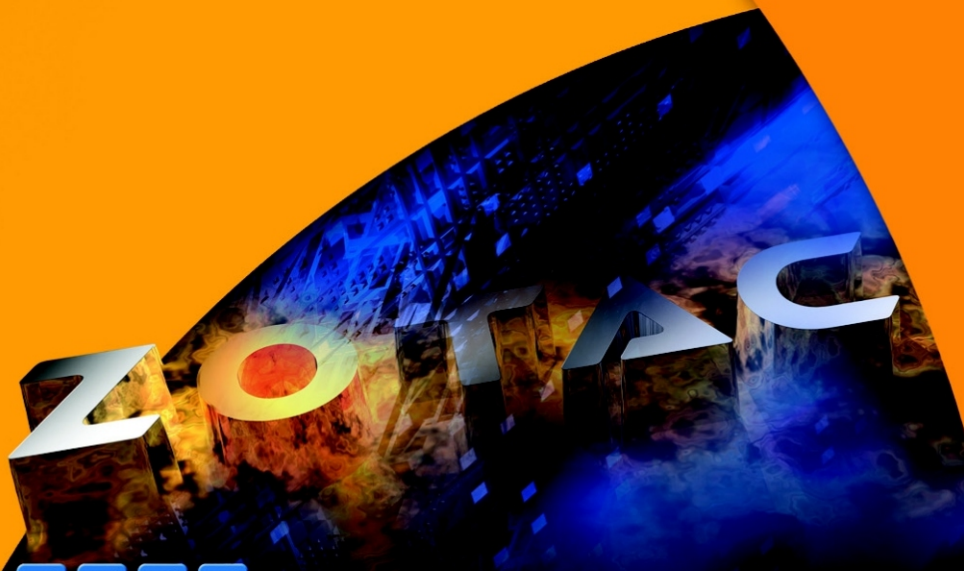

ZOTAC[®] Motherboard



User's Manual



NFORCE 610i-ITX



NFORCE 630i-ITX

INTEL SOCKET 775 - PCI EXPRESS

MOTHERBOARD



Electronic Emission Notices

Federal Communications Commission (FCC) Statement

This equipment has been tested and found to comply with the limits for a Class B digital device, pursuant to Part 15 of FCC Rules. These limits are designed to provide reasonable protection against harmful interference in a residential installation. This equipment generates, uses and can radiate radio frequency energy and, if not installed and used in accordance with instructions contained in this manual, may cause harmful interference to radio and television communications. However, there is no guarantee that interference will not occur in a particular installation.

If this equipment does cause harmful interference to radio or television reception, which can be determined by turning the equipment off and on, the user is encouraged to try to correct the interference by one or more of the following measures:

- REORIENT OR RELOCATE THE RECEIVING ANTENNA
- INCREASE THE SEPARATION BETWEEN THE EQUIPMENT AND THE RECEIVER
- CONNECT THE EQUIPMENT INTO AN OUTLET ON A CIRCUIT DIFFERENT FROM THAT OF THE RECEIVER
- CONSULT THE DEALER OR AN EXPERIENCED AUDIO/TELEVISION TECHNICIAN

NOTE:

Connecting this device to peripheral devices that do not comply with Class B requirements, or using an unshielded peripheral data cable, could also result in harmful interference to radio or television reception.

The user is cautioned that any changes or modifications not expressly approved by the party responsible for compliance could void the user's authority to operate this equipment.

To ensure that the use of this product does not contribute to interference, it is necessary to use shielded I/O cables.

Copyright

This manual is copyrighted with all rights reserved. No portion of this manual may be copied or reproduced by any means.

While every precaution has been taken in the preparation of this manual, no responsibility for errors or omissions is assumed. Neither is any liability assumed for damages resulting from the use of the information contained herein.

Trademarks

All brand names, logos and registered trademarks mentioned are property of their respective owners.

Table of Contents

Motherboard Specifications	4
Motherboard Layout	5
Hardware Installation	7
Safety Instructions	7
Preparing the Motherboard	7
Installing the CPU	7
Installing the CPU Fan	8
Installing Memory DIMMs	8
Installing the Motherboard	8
Installing the I/O Shield	9
Connecting Cables and Setting Switches	9
24-pin ATX Power Connector-PW1	10
4-pin ATX_12V power connector-PW2	10
Serial Port Header-COM	11
SPDIFOut Header(optional)	11
Speaker Header-SPK	11
Hard Disk Connector-IDE	11
Front Panel Header-FP1	12
USB Headers	12
Front Pannel Audio Header-FP_S1	13
Serial-ATA (SATA) Connectors(Optional)	13
Fan Connectors	14
Expansion Slots	14
PCI Express x1 Slots(optional)	14
Jumper Settings	14
Configuring the BIOS	15
Enter BIOS Setup	15
Main Menu	16
Standard CMOS Features Menu	17
Date and Time	17
IDE Channel	17
Drive A	17
Video	17
Halt On	18
Memory	18
Advanced BIOS Features	19
CPU Features	19
Hard Disk Boot Priority	20

Advanced Chipset Features	21
Integrated Peripherals Menu	22
Power Management Setup Menu	23
PnP/PCI Configuration	24
PC health status	25
Frequency/Voltage Control	25
Load Fail-safe Defaults	26
Load Optimized Defaults	26
Set Supervisor/User Password	26
Save & Exit Setup	27
Exit Without Saving	28
Flash Update Procedure	28
Installing Drivers and Software	29
Drivers Installing	29
REALTEK HD AUDIO DRIVER SETUP	32
Getting Started	32
Sound Effect	32
Environment Simulation	32
Equalizer Selection	32
Frequently Used Equalizer Setting	33
Karaoke Mode	33
Mixer	33
Playback control	34
Recording control	34
Audio I/O	35
Speaker Configuration	36
Connector Settings	36
S/PDIF	37
Speaker Calibration	37
Microphone	38
Noise Suppression	38
Beam Forming	38
Acoustic Echo Cancellation	38
Audio Demo	39
Information	39
SATA RAID User Manual	40
Setting up the BIOS	40
Entering the RAID BIOS Setup	41
Installing the RAID Drives	42

Motherboard Specifications

Chipset

NVIDIA MCP73 Series

Size

Mini-ITX form factor of 170mm x 170mm

Microprocessor support

Intel LGA 775 Celeron® , Pentium® 4, Pentium® D, Core™ 2 Series

Operating systems:

Supports Windows XP 32bit/64bit and Windows Vista 32bit/64bit

System Memory support

Supports DDRII533/667(DDRII800 for NForce630i series). Supports up to 4GBs DDRII memorys.

USB 2.0 Ports*

- ❖ Supports hot plug and play
- ❖ Ten USB 2.0 ports (six rear panel ports, four from onboard USB headers)
- ❖ Supports wake-up from S1
- ❖ Supports USB 2.0 protocol up to 480 Mbps transmission rate

Onboard Serial ATA II

- ❖ Independent DMA operation on two ports (optional).
- ❖ Data transfer rates of 3Gb/s.

Onboard LAN

- ❖ LAN interface built-in onboard
- ❖ Supports 10/100Mbps Ethernet

Onboard Audio(optional)

- ❖ Azalia High-Definition audio
- ❖ Supports 6-channel
- ❖ Supports Jack-Sensing function

Green Function

- ❖ Supports ACPI (Advanced Configuration and Power Interface)
- ❖ RTC timer to power-on the system
- ❖ AC power failure recovery

Onboard Graphics support

- ❖ Integrated 300MHz DAC for external desktop display.

Expansion Slots

- ❖ One PCI Express x1 slot(optional)

Motherboard Layout

Figure 1 shows the motherboard and Figure 2 shows the back panel connectors.

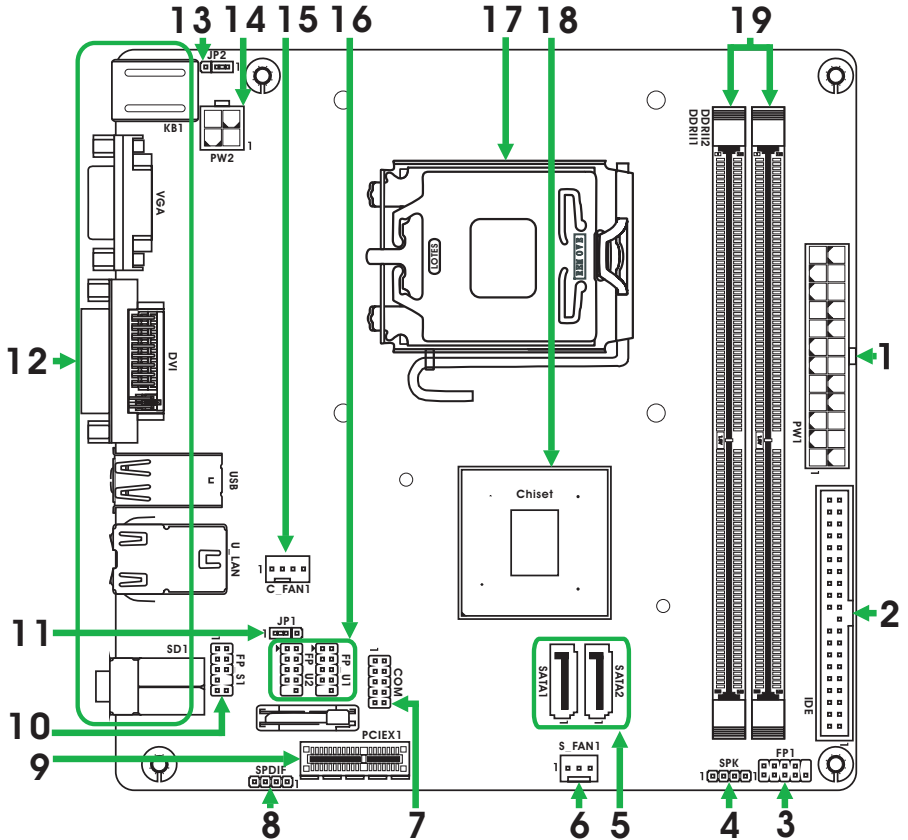
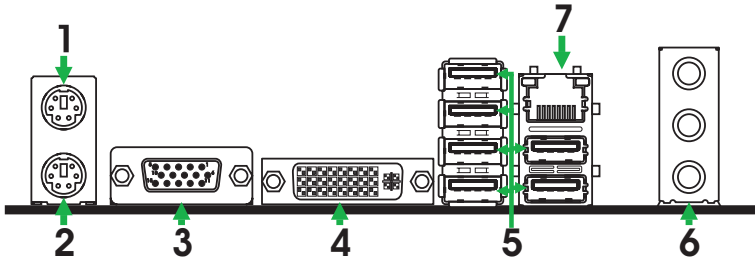

Figure 1. Board Layout

- | | |
|---|---|
| 1. 24-pin ATX Power Connector-PW1 | 11. Clear CMOS Jumper |
| 2. Hard Disk Connector-IDE | 12. Backpanel connectors |
| 3. Front Panel Header-FP1 | 13. P/S port 5V standby selection Power |
| 4. Speaker Header-SPK | 14. 4-pin ATX_12V power connector-PW2 |
| 5. Serial-ATA (SATA) Connectors(optional) | 15. CPU Fan connector |
| 6. SYS Fan connector | 16. USB Headers |
| 7. Serial Port Header-COM | 17. CPU socket |
| 8. SPDIF-OUT Header(optional) | 18. Chipset |
| 9. PCI Express x1 slot(optional) | 19. DDRII DIMM Sockets |
| 10. Front Panel Audio Header-FP_S1 | |

Figure 2: Backpanel connectors



1. PS/2 Mouse Port
2. PS/2 Keyboard Port
3. VGA Connector
4. DVI Connector(optional for NForce630i-ITX)
5. USB Connectors

6. Port	2-Channel	4-Channel	6-Channel
Blue	Line-In	Rear Speaker Out	Rear Speaker Out
Green	Line-Out	Front Speaker Out	Front Speaker Out
Pink	Mic In	Mic In	Center/Subwoofer

7. LAN Connector
 Lan Port with LEDs to indicate status.
 - Yellow/Light Up/Blink = 10 Mbps/Link/Activity
 - Yellow and Green/Light Up/Blink = 100 Mbps/link/Activity

Hardware Installation

This section will guide you through the installation of the motherboard. The topics covered in this section are:

- Preparing the motherboard
 - ❖ Installing the CPU
 - ❖ Installing the CPU fan
 - ❖ Installing the memory
- Installing the motherboard
- Connecting cables and setting switches

Safety Instructions

To reduce the risk of fire, electric shock, and injury, always follow basic safety precautions. Remember to remove power from your computer by disconnecting the AC main source before removing or installing any equipment from/to the computer chassis.

Preparing the Motherboard

The motherboard shipped in the box does not contain a CPU and memory. You need to purchase these to complete this installation.

Installing the CPU

Be very careful when handling the CPU. Make sure not to bend or break any pins on the back. Hold the processor only by the edges and do not touch the bottom of the processor.

Use the following procedure to install the CPU onto the motherboard.

1. Unhook the socket lever by pushing down and away from the socket.
2. Lift the load plate. There is a protective socket cover on the load plate to protect the socket when there is no CPU installed.
3. Remove the protective socket cover from the load plate.
4. Remove the processor from its protective cover, making sure you hold it only by the edges. It is a good idea to save the cover so that whenever you remove the CPU, you have a safe place to store it.
5. Align the notches in the processor with the notches on the socket.
6. Lower the processor straight down into the socket with out tilting or sliding it into the socket.
7. Close the load plate over the CPU and press down while you close and engage the socket lever.

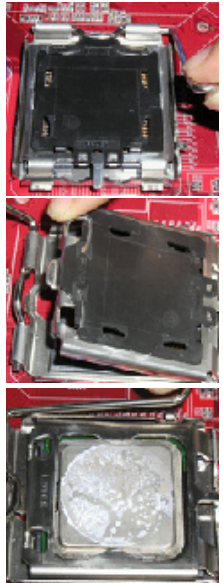

Note: Make sure the CPU is fully seated and level in the socket.

Installing the CPU Fan

There are many different fan types that can be used with this motherboard. Follow the instruction that came with your fan assembly. Be sure that the fan orientation is correct for your chassis type and your fan assembly.

Installing Memory DIMMs

Your new motherboard has two 1.8V 240-pin slots for DDR2 memory. These slots support 256 Mb, 512 Mb, 1Gb and 2Gb DDR2 technologies. There must be at least one memory bank populated to ensure normal operation. Use the following the recommendations for installing memory.

- One DIMM:** Install into slot 1 or 2. You can install the DIMM into any slot, however, slot 1 is preferred.
- Two DIMMs:** Install into slots 1 and 2. The idea is to not have the DIMMs in adjacent slots.

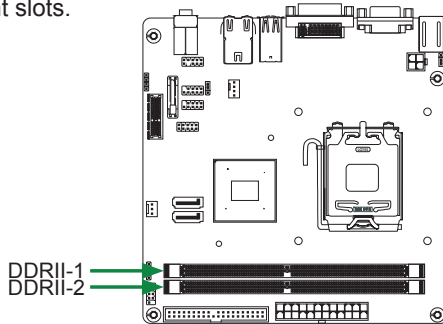

Use the following procedure to install memory DIMMs into the slots on the motherboard. Note that there is only one gap near the center of the DIMM slot. This slot matches the slot on the memory DIMM to ensure the component is installed properly.

1. Unlock a DIMM slot by pressing the module clips outward.
2. Align the memory module to the DIMM slot, and insert the module vertically into the DIMM slot. The plastic clips at both sides of the DIMM slot automatically lock the DIMM into the connector.

Installing the Motherboard

The sequence of installing the motherboard into the chassis depends on the chassis you are using and if you are replacing an existing motherboard or working with an empty chassis. Determine if it would be easier to make all the connections prior to this step or to secure the motherboard and then make all the connections. It is normally easier to secure the motherboard first.

Use the following procedure to install the I/O shield and secure the motherboard into the chassis.

Note: Be sure that the CPU fan assembly has enough clearance for the chassis covers to lock into place and for the expansion cards. Also make sure the CPU Fan assembly is aligned with the vents on the covers.

Installing the I/O Shield

The motherboard kit comes with an I/O shield that is used to block radio frequency transmissions, protects internal components from dust and foreign objects, and promotes correct airflow within the chassis.

Before installing the motherboard, install the I/O shield from the **inside** of the chassis. Press the I/O shield into place and make sure it fits securely. If the I/O shield does not fit into the chassis, you would need to obtain the proper size from the chassis supplier.

Connecting Cables and Setting Switches

This section takes you through all the connections and switch settings necessary on the motherboard. This will include:

- Power Connections
 - ❖ 24-pin ATX Power **Connector-PW1**
 - ❖ 4-pin ATX_12V power **connector-PW2**
- Internal Headers
 - ❖ Serial Port Header-COM
 - ❖ SPDIF Out Header(Optional)
 - ❖ Speaker Header-SPK
 - ❖ Hard Disk Connector-IDE
 - ❖ Front Panel Header-FP1
 - ❖ USB Headers
 - ❖ Front Pannel Audio Header-FP_S1
- Serial ATA II
- Chassis Fans
- Expansion slots
- Jumper settings

24-pin ATX Power Connector-PW1

PW1 is the main power supply connector located along the edge of the board next to the DIMM slots. Make sure that the power supply cable and pins are properly aligned with the connector on the motherboard. Firmly plug the power supply cable into the connector and make sure it is secure.

PW1-Pin Assignments

Pin	Signal	Pin	Signal
1	+3.3V	13	+3.3V
2	+3.3V	14	-12V
3	GND	15	GND
4	+5V	16	PS_ON
5	GND	17	GND
6	+5V	18	GND
7	GND	19	GND
8	PWROK	20	-5V
9	+5V_AUX	21	+5V
10	+12V	22	+5V
11	+12V	23	+5V
12	+3.3V	24	GND

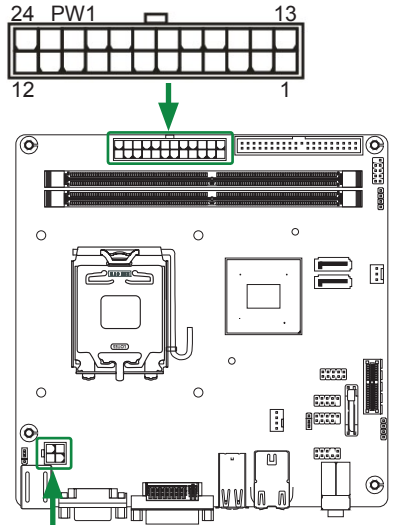

4-pin ATX_12V power connector-PW2

PW2, the 4-pin ATX 12V power connection, is used to provide power to the CPU. Align the pins to the connector and press firmly until seated.

PW2-Pin Definition

Pin	Signal
1	GND
2	GND
3	+12V
4	+12V

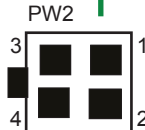

Serial Port Header-COM

COM-Pin Definition

Pin	Signal	Pin	Signal
1	DCD	6	DSR
2	RXD	7	RTS
3	TXD	8	CTS
4	DTR	9	RI
5	GND	10	NC



SPDIF Out Header(optional)

This header provides a SPDIF (Sony/Philips Digital Interface) output to digital multimedia device through coaxial connector.

SPDIF-Pin Definition

Pin	Signal
1	SPDIF-out
2	+3.3V
3	NC
4	GND



Speaker Header-SPK

SPK-Pin Definition

Pin	Signal
1	VCC
2	NC
3	NC
4	SPK-



Hard Disk Connector-IDE

The motherboard has a 32-bit Enhanced PCI IDE and Ultra DMA 66/100/133 controller that provides PIO mode 0~4, Bus Master, and Ultra DMA 66/100/133 function. You can connect up to two hard disk drives, CD-ROM, 120MB Floppy (reserved for future BIOS) and other devices.

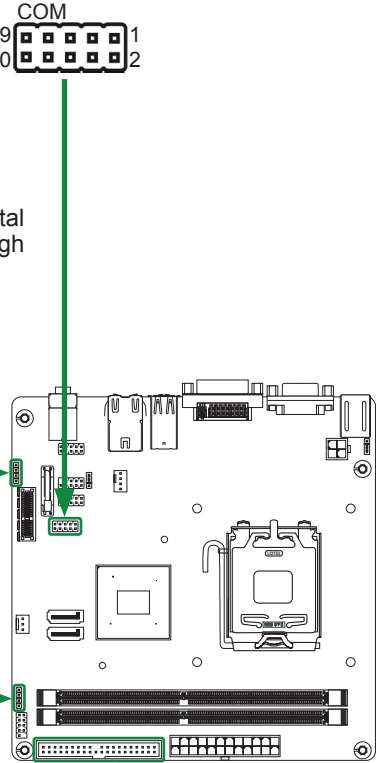

Front Panel Header-FP1

The front panel header on this motherboard is one connector used to connect the following four cables:

PWRLED

Attach the front panel power LED cable to these two pins of the connector. The Power LED indicates the system's status.

PWR SW

Attach the power button cable from the case to these two pins. Pressing the power button on the front panel turns the system on and off rather than using the power supply button.

HDD LED

Attach the hard disk drive indicator LED cable to these two pins. The HDD indicator LED indicates the activity status of the hard disks.

RST SW

Attach the Reset switch cable from the front panel of the case to these two pins. The system restarts when the **RESET** switch is pressed.

FP1-Pin Definition

Pin	Signal	Pin	Signal
1	HDD_LED+	6	PWR_SW
2	PW_LED+	7	RESET
3	HDD_LED-	8	GND
4	PW_LED-	9	NC
5	GND	10	KEY

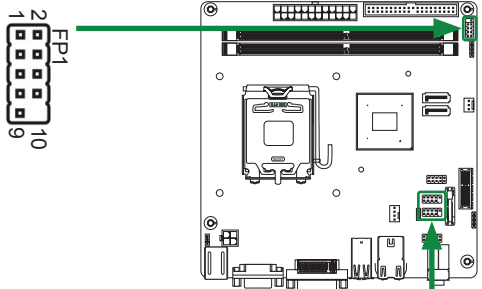

Note:

Some chassis do not have all four cables. Be sure to match the name on the connectors to the corresponding pins.

USB Headers

This motherboard contains six USB 2.0 ports that are exposed on the rear panel of the chassis (Figure 2). The motherboard also contains two 10-pin internal header connectors onboard.

- Secure the bracket to either the front or rear panel of your chassis (not all chassis are equipped with the front panel option).

USB-Pin Definition

PIN	Assignment	PIN	Assignment
1	VCC	6	USBP1+
2	VCC	7	GND
3	USBP0-	8	GND
4	USBP1-	9	KEY
5	USBP0+	10	OC#

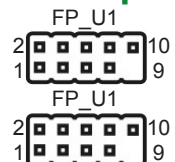

Front Panel Audio Header-FP_S1

The audio connector supports HD audio standard and provides two kinds of audio output choices: the Front Audio, the Rear Audio. The front Audio supports re-tasking function.

FP_S1-Pin Definition

PIN	Assignment	PIN	Assignment
1	MIC2(L)	6	Reserved
2	GND	7	FAVDIO-JD
3	MIC(R)	8	Key(No pin)
4	-ACZ-DET	9	Front Audio(L)
5	Front Audio(R)	10	Reserved

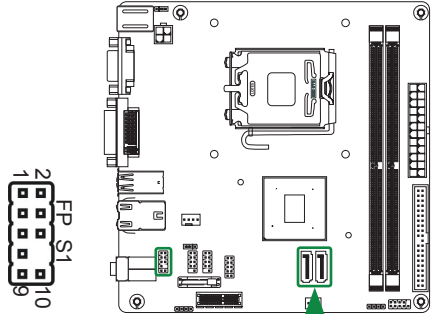

Note:

In order to utilize the front audio header, your chassis must have front audio connector. Also please make sure the pin assignment on the cable is the same as the pin assignment on the mainboard header. To find out if the chassis you are buying supports a front audio connector, please contract your dealer.

Serial-ATA (SATA) Connectors(Optional)

The Serial ATA II connector is used to connect the Serial ATA II device to the motherboard. These connectors support the thin Serial ATA II cables for primary storage devices. The current Serial ATA II interface allows up to 3Gb/s data transfer rate.

There are two serial ATA connectors on the motherboard that support AHCI and RAID configurations.

SATA-Pin Definition

Pin	Signal
1	GND
2	TXP
3	TXN
4	GND
5	RXN
6	RXP
7	GND

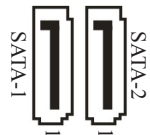

Fan Connectors

There are two Fan Connectors on the motherboard. The fan speed can be detected and viewed in the PC Health Status section of the CMOS Setup.

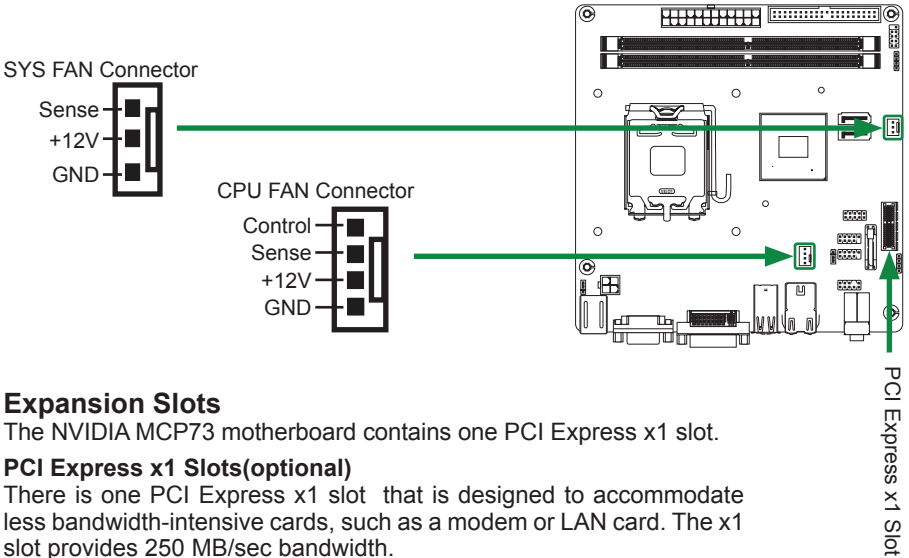

Expansion Slots

The NVIDIA MCP73 motherboard contains one PCI Express x1 slot.

PCI Express x1 Slots(optional)

There is one PCI Express x1 slot that is designed to accommodate less bandwidth-intensive cards, such as a modem or LAN card. The x1 slot provides 250 MB/sec bandwidth.

Jumper Settings

This chapter explains how to configure the motherboard's hardware. Before using your computer, make sure all jumpers and DRAM modules are set correctly. Refer to this chapter whenever in doubt.

CMOS Clear Jumper-JP1

JP1	Selection
1 <input checked="" type="checkbox"/> 1-2*	Normal*
1 <input type="checkbox"/> 2-3	CMOS Clear

P/S Port 5V Standby Power Jumper-JP2(Optional)

JP2	Selection
1 <input checked="" type="checkbox"/> 1-2*	5V standby power input*
1 <input type="checkbox"/> 2-3	5V power input

Close Open * = Default setting.

If you want to clear the system configuration, use the JP1 (Clear CMOS Jumper) to clear data

Notice:

1. Be sure to save the CMOS setting when exit the CMOS.
2. If the CPU is frequency multiplier locked, no CPU speed change will be seen even if the frequency multiplier setting in CMOS setup is changed.

Configuring the BIOS

This section discusses how to change the system settings through the BIOS Setup menus. Detailed descriptions of the BIOS parameters are also provided.

This section includes the following information:

- Enter BIOS Setup
- Main Menu
- Standard CMOS Features
- Advanced BIOS Features
- Advanced Chipset Features
- Integrated Peripherals
- Power Management Setup
- PnP/PCI Configurations
- Pc health status
- Frequency/Voltage Control

Enter BIOS Setup

The BIOS is the communication bridge between hardware and software. Correctly setting the BIOS parameters is critical to maintain optimal system performance.

Use the following procedure to verify/change BIOS settings.

1. Power on the computer.,
2. Press the **Del** key when the following message briefly displays at the bottom of the screen during the Power On Self Test (POST).

Press F1 to continue, DEL to enter Setup.

Pressing **Del** takes you to the Phoenix-Award BIOS CMOS Setup Utility.

Note: It is strongly recommended that you do not change the default BIOS settings. Changing some settings could damage your computer.

Main Menu

The main menu allows you to select from the list of setup functions and two exit choices. Use the **Page Up** and **Page Down** keys to scroll through the options or press **Enter** to display the associated submenu. Use the **↑ ↓** arrow keys to position the selector in the option you choose. To go back to the previous menu, press **Esc**.

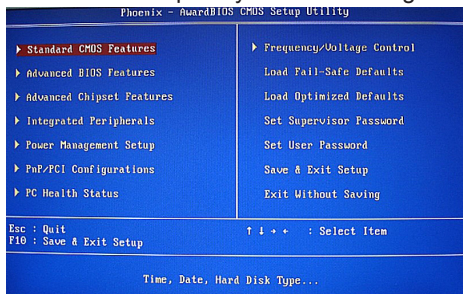

Note:

that on the BIOS screens all data in white is for information only, data in yellow is changeable, data in blue is non-changeable, and data in a red box is highlighted for selection.

- Standard CMOS Features**
Use this menu to set up the basic system configuration.
- Advanced BIOS Features**
Use this menu to set up the advanced system features and boot sequence.
- Advanced Chipset Features**
Use this menu to optimize system performance.
- Integrated Peripherals**
Use this menu to set up onboard peripherals such as IDE, RAID, USB and LAN control.
- Power Management Setup**
Use this menu to configure power management, power on, and sleep features.
- PnP/PCI Configurations**
Use this menu to modify the system's Plug-and-Play and PCI configurations.
- Pc health status**
Use this menu to monitor the real-time system status of your PC.

The following items on the CMOS Setup Utility main menu are commands rather than submenus:

- Load Optimized Defaults**
Load default system settings.
- Set Supervisor and User Password**
Use this command to set, change, and disable the password used to access the system and the BIOS menu.
- Save & Exit Setup**
Use this command to save settings to CMOS and exit setup.
- Exit Without Saving**
Use this command to abandon all setting changes and exit setup.

Standard CMOS Features Menu

The Standard CMOS Features menu is used to configure the standard CMOS information, such as the date, time, HDD model, and so on. Use the **Page Up** and **Page Down** keys to scroll through the options or press **Enter** to display the sub-menu. Use the **↑ ↓** arrow keys to position the selector in the option you choose. To go back to the previous menu, press **Esc**.

The information shown in **Item Help** corresponds to the option highlighted.

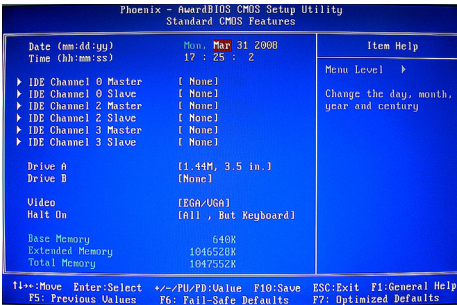

Note:

that all data in white is for information only, data in yellow is changeable, data in blue is non-changeable, and data in a red box is highlighted for selection.

Date and Time

Using the arrow keys, position the cursor over the month, day, and year. Use the Page Up and Page Down keys to scroll through dates and times. Note that the weekday (Sun through Sat) cannot be changed. This field changes to correspond to the date you enter. Note that the hour value is shown in a 24-hour clock format. Time is represented as **hour : minute : second**.

IDE Channel

Use these functions to detect and configure the individual IDE channels. Select a channel and press Enter to display the IDE sub-menu.

Press **Enter** to auto-detect IDE channels in the system. Once the channel is detected, the values for Capacity, Cylinder, Head, Precomp, Landing Zone, and Sector are automatically filled in.

None

There is no HDD installed or set.

Auto

The system can auto-detect the hard disk when booting up.

Manual

When you set the channel to **[Manual]** and change **Access Mode** to **[CHS]**, you can then enter the number of cylinders, heads, Precomp, landing zone, and sector.

Drive A

The **Drive A** option allows you to select the kind of FDD to install.

Video

Use this option to choose the mode of Video, as EGA/VGA, CGA 40, CGA 80, MONO.

Halt On

Halt On determines whether or not the computer stops if an error is detected during power on. Use the **Page Up** and **Page Down** keys to scroll through the options or press **Enter** to display the **Halt On** sub-menu. Use the **↑ ↓** arrow keys to position the selector in the option you choose. Press **Enter** to accept the changes and return to the Standard CMOS Features menu.

All Errors

Whenever the BIOS detects a nonfatal error, the system stops and prompts you.

No Errors

System boot does not stop for any detected errors.

All, But Keyboard

System boot does not stop for keyboard errors, but does stop for all other errors.

All, But Diskette

The system boot does not stop for a diskette error but will stop for all other errors.

All, But Disk/Key

The system boot does not stop for a diskette or keyboard error but will stop for all other errors.

Memory

These settings are *display-only values* that are determined by the BIOS POST (Power-On Self Test).

Base Memory

BIOS POST determines the amount of base (or conventional) memory installed in the system.

Extended Memory

BIOS determines how much extended memory is present during the POST.

Total Memory

This value represents the total memory of the system.

Advanced BIOS Features

Access the Advanced BIOS Features menu from the CMOS Utility Setup screen. Use the **Page Up** and **Page Down** keys to scroll through the options or press **Enter** to display the sub-menu. Use the **↑ ↓** arrow keys to position the selector in the option you choose. To go back to the previous menu, press **Esc**.

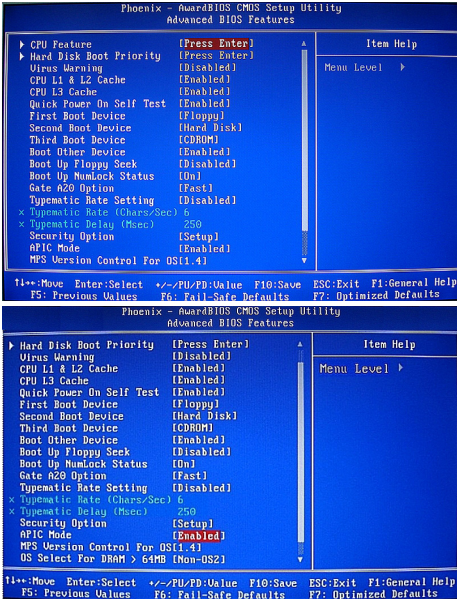

Note:

The options that have associated sub-menus are designated by a ▶, which precedes the option. Press Enter to display the sub-menus.

Note:

that all data in white is for information only, data in yellow is changeable, data in blue is non-changeable, and data in a red box is highlighted for selection.

CPU Feature

Press Enter to display CPU Feature menu, then the following items will be displayed:

PPM Mode

Use this option to choose the mode of PPM.

Limit CPUID MaxVal

Use this option to enable or disable the function of Limiting CPUID MaxVal

C1E Function

Select CPU C1E function.

Execute Disable Bit

When disabled forces the XD feature flag to always return 0, defaults choose Enable.

Virtualization Technology

Use this option to enable or disable Virtualization Technology.

Core Multi-Processing

Use this option to enable or disable Core Multi-Processing.

Hard Disk Boot Priority

Press Enter to display Hard Disk Boot Priority menu, then some of the peripheral equipment plugged will be displayed.

Bootable Add-in Cards

Use this option to bootable add-in cards.

Virus Warning

Allow you to choose the Virus Warning feature for IDE Hard Disk boot sector protection.

CPU L1&L2 Cache/CPU L3 Cache

Use these options to disable or enable L1/L2/L3 cache.

Quick Power On Self Test

Enabling this option allows the system to skip certain test while booting, which reduces the time needed to boot the system.

First/Second/Third Boot Device

Use this option to set the priority sequence of the devices booted at power on. Use the **Page Up** and **Page Down** keys to scroll through the options or press **Enter** to display the sub-menu. Use the **↑ ↓** arrow keys to position the selector in the option you choose.

Boot Other Device

With the option set to **Enable**, the system boots from some other device if the first/second/third boot devices fail.

Boot Up Floppy Seek

Enabled tests floppy drives to determine whether they have 40 or 80 tracks.

Boot Up NumLock Status

This option allows you to select the power-on state of **NumLock**. Select **On** to activate the keyboard **NumLock** when the system is started. Select **Off** to disable the **NumLock** key.

Gate A20 Option

Use this option to choose Gate A20 menu.

Typematic Rate Setting

Use this option to set keystrokes repeat. if Enabled, display options as follows:

❖ Typematic Rate

❖ Typematic delay

Security Option

The Security Options allows you to require a password every time the system boots or only when you enter setup. Select **Setup** to require a password to gain access to the CMOS Setup screen. Select **System** to require a password to access the CMOS Setup screen and when the system boots.

APIC Mode

Use this function to enable or disable the Advanced Programmable Interrupt Controller (APIC). If you disable this option, you also disable the MPS Version Control for OS option.

MPS Version Control For OS

Use this function to select the Multi-Processor Specification (MPS) version that BIOS passes to the operating system. Use the **Page Up** and **Page Down** keys to scroll through the options.

Full Screen LOGO Show

This option allows you to enable or disable the display of the full-screen logo when the system boots. Use the **Page Up** and **Page Down** keys to toggle between **Enable** and **Disable**.

 Small LoGo (EPA) Show

This option allows you to enable or disable the display of the Small LoGo when the system boots.

Advanced Chipset Features

Select Advanced Chipset Features from the CMOS Setup Utility menu and press Enter to display the functions of the Advanced Chipset Functions menu.

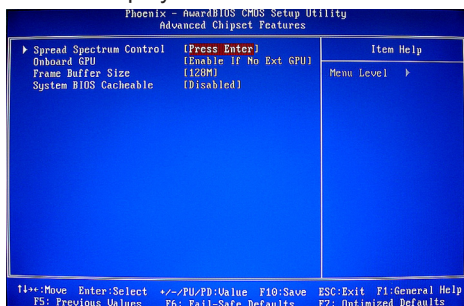
 Spread Spectrum Control

Use this option to set Spread Spectrum

 Onboard GPU

Use this option to set Onboard GPU

 Frame Buffer Size

Use this option to change Buffer Size

 System BIOS Cacheable

Use this option to enable or disable the System BIOS Cacheable

Integrated Peripherals Menu

Select **Integrated Peripherals** from the CMOS Setup Utility menu and press **Enter** to display the Integrated Peripherals menu.

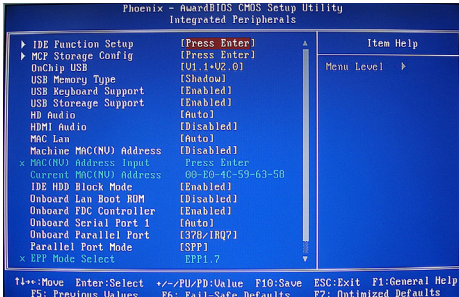

- IDE Function Setup**
Use this option to set IDE function
- MCP Storage Config**
Use this option to set MCP Storage
- OnChip USB**
Use this option to set OnChip USB
- USB Memory Type**
Use this option to change USB Memory Type
- USB Keyboard Support**
Use this option to enable or disable USB Keyboard
- USB Storage Support**
Use this option to enable or disable USB Storage
- HD/HDMI Audio**
Use this option to set HD/HDMI Audio
- MAC Lan**
Use this option to set MAC Lan
- Machine MAC(NV) Address**
When set this option to "Enable", you can set a new address for current MAC(NV)
- IDE HDD Block Mode**
Use this option to enable or disable IDE HDD Block Mode
- Onboard Lan Boot Rom**
Use this option to enable or disable Onboard Lan Boot Rom
- Onboard FDC Controller**
Use this option to enable Onboard FDC Controller
- Onboard Serial Port1**
Use this option to change serial port setting
- Onboard Parallel port**
Use this option to change parallel port setting
- Parallel Port Mode**
Use this option to change Parallel Port Mode

Power Management Setup Menu

Select **Power Management Setup** from the CMOS Setup Utility menu and press Enter to display the Power Management Setup menu.

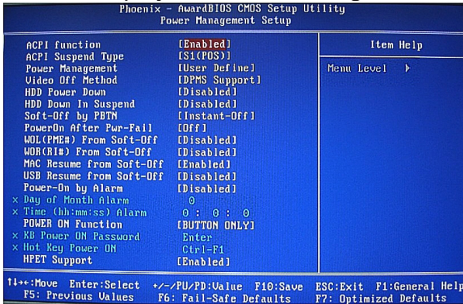

ACPI Function

This function on the Power Management Setup menu allows you to enable or disable the ACPI function.

Power Management

Use this option to set the mode for Power Management

Video Off Method

Use this option to set a Method for Video off.

HDD Power Down

Use this option to enable or disable a mode of HDD Power down.

Soft-Off by PBTN

This function on the Power Management Setup menu allows you to set Soft-Off by PBTN to **[Instant-Off]** or **[Delay 4 Sec]**.

PowerOn after PWR-fail

Use this option to change its setting

Power-On by Alarm

Determines whether to power on the system at a desired time. If enable set the date and time as following:

- ❖ **Date(of Month) Alarm:** Turn on the system at a specific time on each day or on a specific day in a month.
- ❖ **Time(hh:mm:ss) Alarm:** Set the time at which the system will be Powered on automatically.

PowerOn Function

Use this option to Power On Mode(by button only,keyboard 98,mouse left/right,hot key, password or any key.)

HPET Support

Use this option to enable or disable HPET Support; if enable, HPET Mode display. We can select.

PnP/PCI Configurations

Select **PnP/PCI Configuration** from the CMOS Setup Utility menu and press **Enter** to display the PnP/PCI Configuration menu.

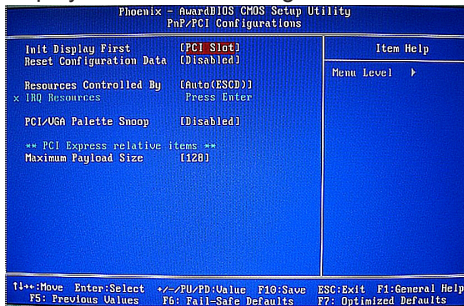

Init Display First

This function on the PnP/PCI Configuration menu allows you to define if the initial display is in the PCI slot, onboard or PCI Express slot. Options are **[PCI Slot]**, **[Onboard]** and **[PCIEx]**.

Reset Configuration Data

This function on the PnP/PCI Configuration menu allows you to enable or disable the resetting of Extended System Configuration Data (ESCD) when you exit Setup. Set this to **[Enabled]** if you have installed a new add-on and the system reconfiguration has caused a serious conflict that prevents the OS from booting. The default setting is **[Disabled]**.

Resources Controlled By

This function on the PnP/PCI Configuration menu allows you to define if the BIOS can automatically configure all the boot and plug-and-play compatible devices or if you can manually select IRQ, DMA, and memory base address fields. Select **[Auto(ESCD)]** if you want the BIOS to automatically populate these fields. If you select **[Manual]** so you can assign the resources, **IRQ Resources** is enabled for input.

IRQ Resources

To enable this field for input, set **Resources Controlled By** to **[Manual]**. With this field enabled, press **Enter** to see options.

Use Legacy ISA for devices compliant with the original PC AT Bus specification. Use PCI/ISA PnP for devices compliant with the plug-and-play standard, whether designed for PCI or ISA Bus architecture.

PCI/VGA Palette Snoop

This function on the PnP/PCI Configuration menu allows you to enable or disable the Palette Snoop function.

Maximum Payload Size

This function on the PnP/PCI Configuration menu allows you to set the maximum TLP payload size (in bytes) for the PCI Express devices. Use the **Page Up** and **Page Down** keys to scroll through sizes or enter the number using the keyboard numbers or use the + and – keys to go up and down the list of sizes.

PC health Status

Select **PC health Status** from the CMOS Setup Utility menu and press **Enter** to display the System Monitor menu.

Phoenix - AwardBIOS CMOS Setup Utility		Item Help
PC Health Status		
Smart Fan Tiger Temperature	[Disabled]	
x CPU Fan Tolerance Units	5	
Current CPU Temperature	34°C / 93°F	Menu Level ▶
Current System Temp	22°C / 71°F	
SVS Fan Speed	0 RPM	
CPU Fan Speed	3276 RPM	
MCP Fan Speed	0 RPM	
CPU Core	1.32V	
VBDR Voltage	1.88V	
+1.2V Voltage	1.23V	
+5V Voltage	4.98V	
+12V Voltage	12.14V	
VCC	5.12V	
BAT Voltage	3.15V	
5VSB Voltage	5.15V	
F1: Move Enter: Select +/- /PU/PD: Value F10: Save ESC: Exit F1: General Help F5: Previous Values F6: Fail-Safe Defaults F7: Optimized Defaults		

All of the values shown in are dynamic and change as the speed and voltages of the various components change with system usage.

Smart Fan Tiger Temperature

Use this option to change its setting.

Frequency/Voltage Control

Select Frequency/Voltage Control from the CMOS Setup Utility menu and press Enter to display the system Monitor menu.

Phoenix - AwardBIOS CMOS Setup Utility		Item Help
Frequency/Voltage Control		
▶ System Clocks	[Press Enter]	
▶ FSB & Memory Config	[Press Enter]	Menu Level ▶
NB Voltage Control	[1.380V]	
CPU Clock Ratio	[9 X]	
F1: Move Enter: Select +/- /PU/PD: Value F10: Save ESC: Exit F1: General Help F5: Previous Values F6: Fail-Safe Defaults F7: Optimized Defaults		

System Clock

Press "Enter" to display System Clock status

FSB&Memory config

Use this option to change FSB&Memory setting

NB Voltage control

Use this option to set NB Voltage

Load Fail-Safe Defaults

Press <Enter> on this item and then press the <Y> key to load the Fail-Safe BIOS default settings. You can try to Load Fail-Safe Default when the system is unstable.

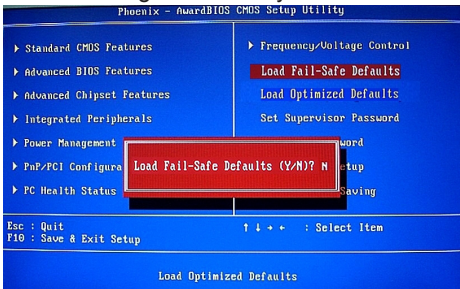

Load Optimized Defaults

Press <Enter> on this item and then press the <Y> key to load the optimal BIOS default settings. The BIOS optimized defaults settings helps the system to operate in optimum state. Always load the Optimized defaults after updating the BIOS or after clearing the CMOS values.

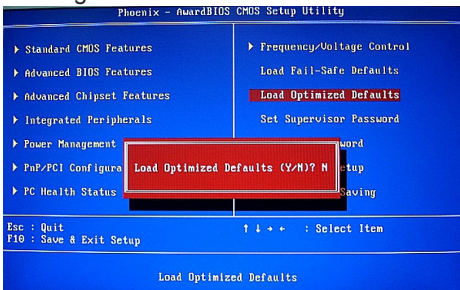

Set Supervisor/User Password

Press <Enter> on the item “Set Supervisor Password” or “Set User Password” and type the password with up to 8 characters and then press <Enter>. You will be requested to confirm the password. Type the password again and press <Enter>.

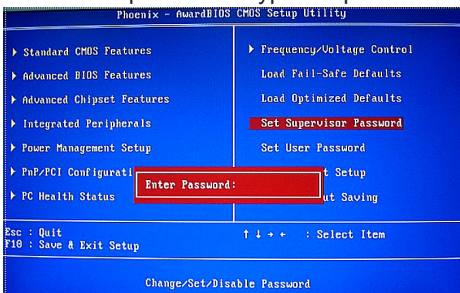

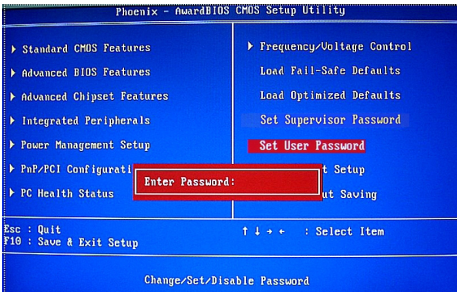

The BIOS Setup program allows you to specify two separate passwords:

❖ **Supervisor Password**

When a system password is set and the **Password Check** item in **Advanced BIOS Features** is set to **Setup**, you must enter the supervisor password for entering BIOS Setup and making BIOS changes.

When the **Password Check** item is set to **System**, you must enter the supervisor password (or user password) at system startup and when entering BIOS Setup.

❖ **User Password**

When the **Password Check** item is set to **System**, you must enter the supervisor password (or user password) at system startup to continue system boot. In BIOS Setup, you must enter the supervisor password if you wish to make changes to BIOS settings. The user password only allows you to view the BIOS settings but not to make changes.

To clear the password, press <Enter> on the password item and when requested for the password, press <Enter> again. The message "PASSWORD DISABLED" will appear, indicating the password has been cancelled.

Save & Exit Setup

Press <Enter> on this item and press the <Y> key. This saves the changes to the CMOS and exits the BIOS Setup program. Press <N> or <Esc> to return to the BIOS Setup Main Menu.

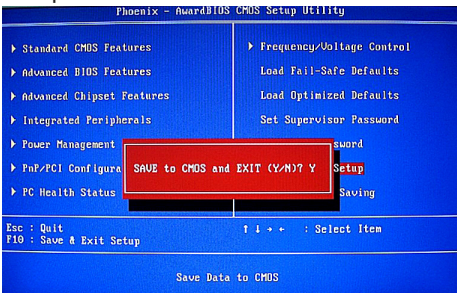

Exit Without Saving

Press <Enter> on this item and press the <Y> key. This exits the BIOS Setup without saving the changes made in BIOS Setup to the CMOS. Press <N> or <Esc> to return to the BIOS Setup Main Menu.

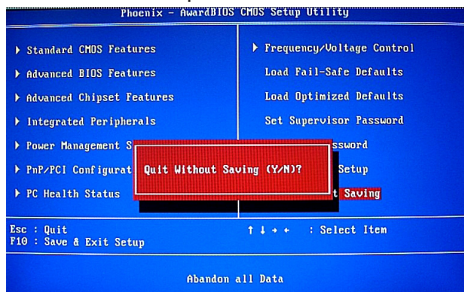

FLASH Update Procedure

The program AWDFLASH.EXE is included on the driver CD (D:\Utility\AWDFLASH.EXE). Please follow the recommended procedure to update the flash BIOS, as listed below.

1. Create a DOS-bootable floppy diskette. Copy the new BIOS file (just obtained or downloaded) and the utility program AWDFLASH.EXE to the diskette.
2. Allow the PC system to boot from the DOS diskette.
3. At the DOS prompt, type AWDFLASH<ENTER>
4. Enter the file name of the new BIOS.
5. The question: "Do you want to save BIOS (Y/N)?" is displayed.
Press "N" if there is no need to save the existing BIOS.
Press "Y" if a backup copy of the existing BIOS is needed.
(A file name has to be assigned to the existing BIOS binary file.)
6. The message : "Press "Y" to program or "N" to exit" is displayed. Type "Y"<ENTER>
7. Wait until the flash-update is completed.
8. Restart the PC.

Warning :- Do not turn off or RESET the computer during the flash process.
 - If you are not sure how to upgrade the BIOS, please take your computer to an Authorized Service Center and have a trained technician do the work for you.

Installing Drivers and Software

Note: *It is important to remember that before installing the driver CD that is shipped in the kit, you need to load your operating system. The motherboard supports Windows XP 32bit and 64bit and is Vista-capable.*

The kit comes with a CD that contains utility drivers and additional software.

Drivers Installation

1. Insert the driver CD after loading your operating system. Waiting for one minute you can see below interface.

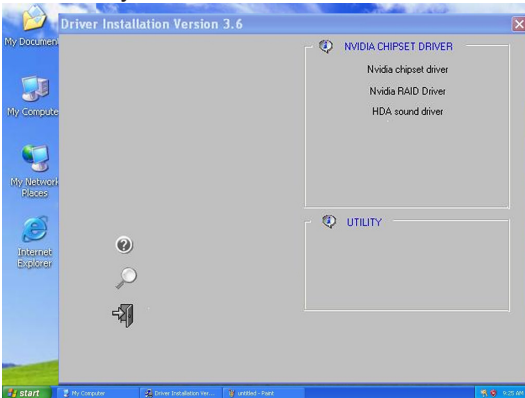

2. Follow the below steps to install driver.

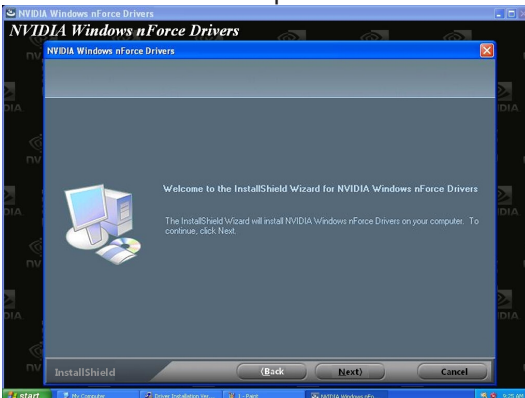

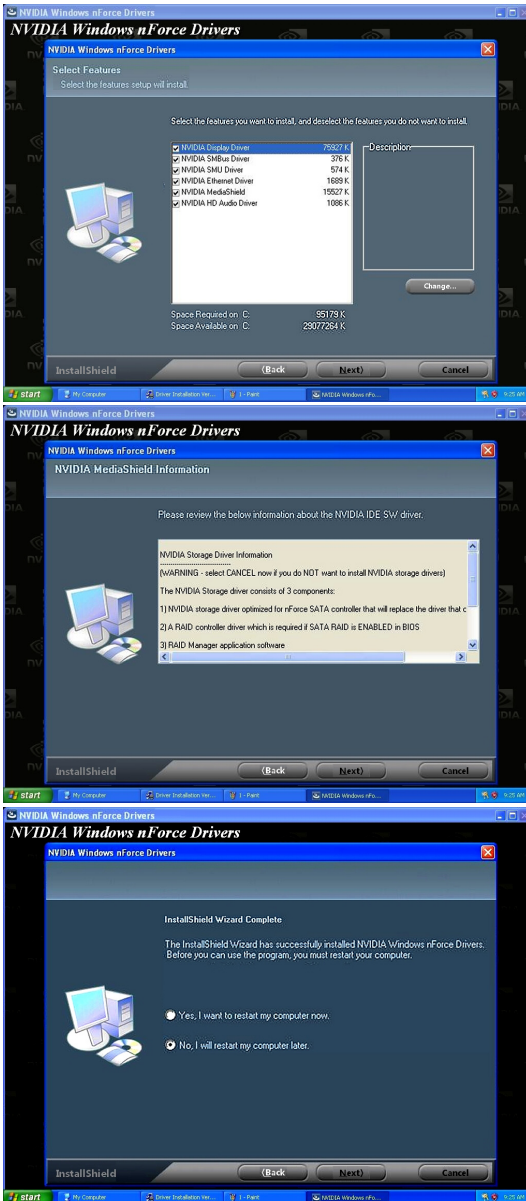

3. Follow the below for HDA sound driver installing.



4. At last, you can open below page that provides information about the hardware devices on this motherboard, and check whether finish your installation.

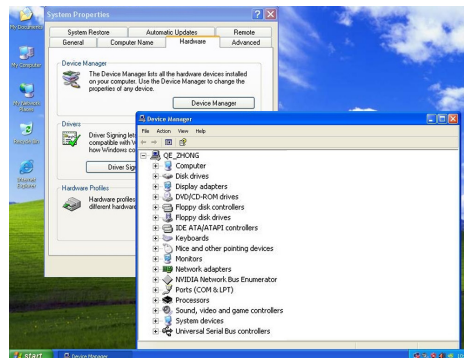

Realtek HD Audio Driver Setup

Getting Started

After Realtek HD Audio Driver being installed (insert the driver CD and follow the on-screen instructions), “Realtek HD Audio Manager” icon will show in System tray as below. Double click the icon and the control panel will appear:



Sound Effect

After clicking on the “Sound Effect” tab, 3 sections “Environment”, “Equalizer” and “Karaoke” are available for selection.



Environment Simulation

You will be able to enjoy different sound experience by pulling down the arrow, totally 23 kinds of sound effect will be shown for selection. Realtek HD Audio Sound Manager also provides five popular settings “Stone Corridor”, “Bathroom”, “Sewer pipe”, “Arena” and “Audio Corridor” for quick enjoyment.

Equalizer Selection

The Equalizer section allows you to create your own preferred settings by utilizing this tool. In standard 10 bands of equalizer, ranging from 100Hz to 16KHz are available:

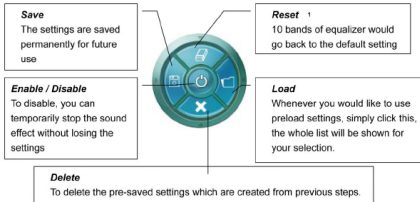

Frequently Used Equalizer Setting

Realtek recognizes the needs that you might have. By leveraging our long experience at audio field, Realtek HD Audio Sound Manager provides you certain optimized equalizer settings that are frequently used for your quick enjoyment.

How to Use

Other than the buttons “Pop” “Live” “Club” & “Rock” shown on the page, to pull down the arrow in “Others”, you will find more optimized settings available to you.

Karaoke Mode

Karaoke mode brings Karaoke fun back home by simply using the music you usually play, Karaoke mode can help you eliminate the vocal of the song or adjust the key to accommodate your range.

Vocal Cancellation

Single click on “Voice Cancellation”, the vocals of the songs will be erased, while the background music is still playing which lets you take over the vocal part.

Key Adjustment

Using “Up / Down Arrow” to find a key which better fits your vocal range.

Mixer

Realtek HD Audio Sound Manager integrates Microsoft’s “Volume Control” functions into the Mixer page. This gives you the advantage to you to create your favorite sound effect in one single tool.



Playback control

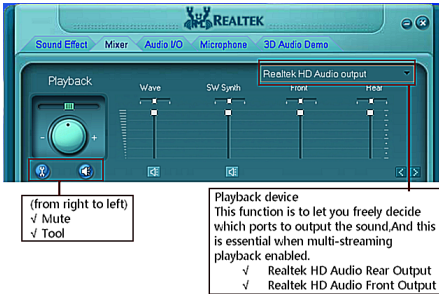

Mute

You may choose to mute single or multiple volume controls or to completely mute sound output.

Tool

✓ Show the following volume control

This is to let you freely decide which volume control items to be displayed, total 13 items to be chosen.

✓ Advanced controls

✓ Enable playback multi-streaming

With this function, you will be able to have an audio chat with your friends via headphone (stream 1 from front panel) while still have music (stream 2 from back panel) playing. At any given period, you can have maximum 2 streams operating simultaneously.

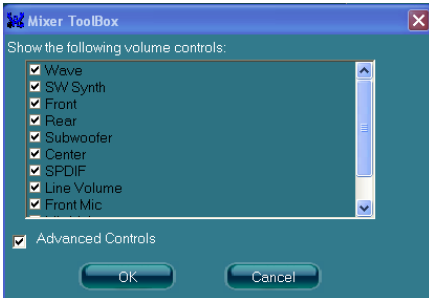

Recording control

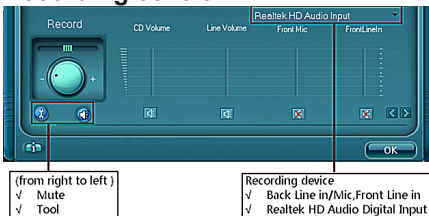

Mute

You may choose to mute single or multiple volume controls or to completely mute sound input.

Tool

- ✓ **Show the following volume controls**
This is to let you freely decide which volume control items to be displayed.
- ✓ **Advanced controls.**
Advanced control is a “Microphone Boost” icon.
Once this item is checked, you will find “advanced” icon beside “Front Pink In” & “Mic Volume”. With this, the input signal into “Front Pink In” & “Mic Volume” will be strengthen.
- ✓ **Enable recording multi-streaming**
At any given period, you can have maximum 2 streams operating simultaneously.

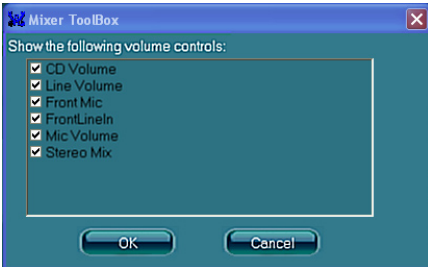

Audio I/O

Realtek HD Audio Manager frees you from default speaker settings. Different from before, for each jack, they are not limited to perform certain functions. Instead, now each jack is able to be chosen to perform either output (i.e. playback) function or input (i.e. Recording) function, we call this “Retasking”.

Audio I/O aims to help you setting jacks as you wish. Moreover, other than blue to blue, pink to pink, the way that you used to do, Audio I/O would guide you to other right jacks that can also serve as microphone/speaker/headphone.



Speaker Configuration

Step 1: Plug in the device in any available jack.

Step 2: Dialogue “connected device” will pop up for your selection. Please select the device you are trying to plug in.

- * If the device is being plugged into the correct jack, you will be able to find the icon beside the jack changed to the one that is same as your device.
- * If not correct, Realtek HD Audio Manager will guide you to plug the device into the correct jack.

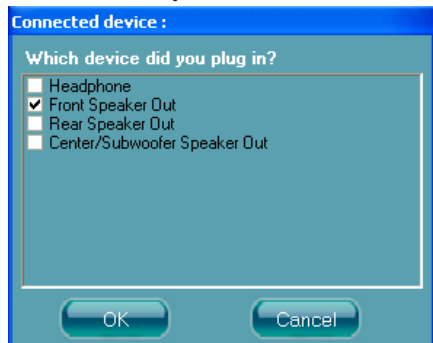

Connector Settings

Click  to access connector settings

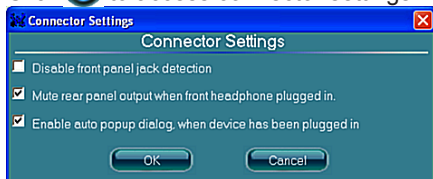

- √ **Mute rear panel when front headphone plugged in**
Once this option is checked, when front headphone is plugged, the music that is playing from the back panel, will be stopped.
- √ **Disable front panel jack detection (option)**
Did not find any function on front panel jacks?
Please check if front jacks on your system are so-called AC'97 jacks. If so, please check this item to disable front panel jack detection.
- √ **Enable auto popup dialogue, when device has been plugged in.**
Once this item checked, the dialog “Connected device” would automatically pop up when device plugged in.

S/PDIF

Short for **Sony/Philips Digital Interface**, a standard audio file transfer format. S/PDIF allows the transfer of digital audio signals from one device to another without having to be converted first to an analog format. Maintaining the viability of a digital signal prevents the quality of the signal from degrading when it is converted to analog.

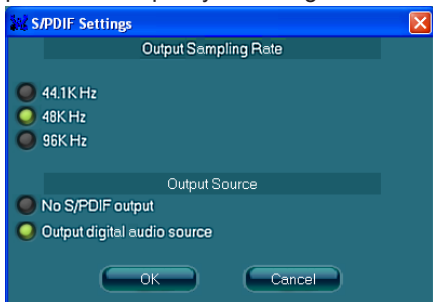

✓ Output Sampling Rate

- 44.1KHz: This is recommended while playing CD
- 48KHz: This is recommended while playing DVD or Dolby.
- 96KHz: This is recommended while playing DVD-Audio.

✓ Output Source

- Output digital audio source: The digital audio format (such as .wav, .mp3, .midi etc) will come out through S/PDIF-Out.

Speaker Calibration

After you have successfully plugged in speakers and assigned to the right jacks, you are only one more step to go to enjoy the intended sound. We provide "Speaker Calibration" to help you check if the speakers are located in the correct position.



Microphone

This page is designed to provide you better microphone / recording quality.

Below picture indicates both “Noise Suppression” & “Acoustic Echo Cancellation” are both enabled.



Noise Suppression

If you feel that the background noise, especially the sound generated from the fan inside PC, is too loud? Try “Noise Suppression”, which allows you to cut off and suppress disturbing noise.

Beam Forming

Also known as “directional recording”, this option lets you do the following: Once beam forming is enabled; only the sound from certain direction will be recorded. You will get the best quality if you chose 90° position, which we recommend you to use, this effectively means that you speak right into the microphone.

Note: A Stereo Microphone is required when using Beam Forming function.

Acoustic Echo Cancellation

This function prevents playback sound from being recorded by microphone together with your sound. For example, you might have chance to use VOIP function through Internet with your friends. The voice of your friend will come out from speakers (playback). However, the voice of your friend might also be recorded into your microphone then go back to your friend through Internet. In that case, your friend will hear his/her own voice again. With AEC (Acoustic Echo Cancellation) enabled at your side, your friend can enjoy the benefit with less echo.

Audio Demo

The section “3D Audio Demo” grants you another possibility to enjoy your sound. The Audio Demo allows you to listen to sound in an extraordinary way.



Information

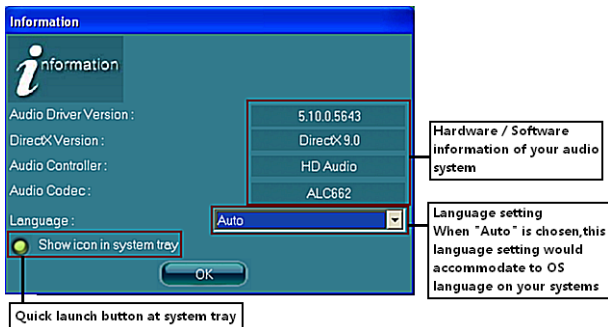

This section provides information about your current system audio device.

SATA RAID User Manual

Setting up the BIOS

1. Setting your computer, then press Delete to enter the Bios setup. The BIOS CMOS Setup Utility window appears.

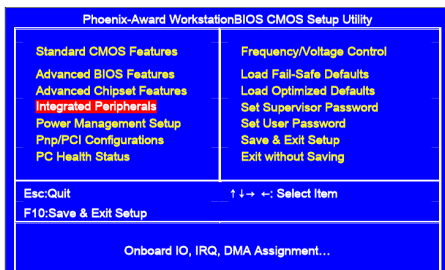

2. Use the arrow keys to select Integrated Peripherals, then press Enter. The Integrated Peripherals window appears.

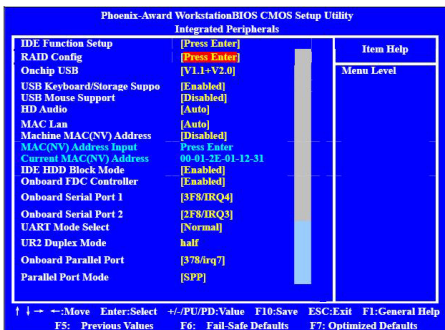

3. Use the arrow keys to select the RAID Config, then press Enter. The RAID Config window appears.

4. From the RAID Config window, enable RAID, then enable the disks that you want to use as RAID disks.

5. Press F10 to save the configuration and exit. The PC reboots.

6. Enter the RAID BIOS Setup by pressing F10 when prompted, and proceed to set up the NVRAID BIOS as described in the next Section.

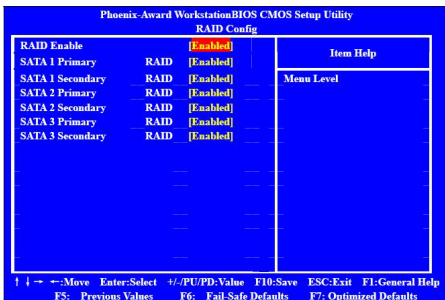

Entering the RAID BIOS Setup

1. After rebooting your computer, wait until you see the RAID software prompt
you to press F10.
2. The NVIDIA RAID Utility –Define a New Array window appears

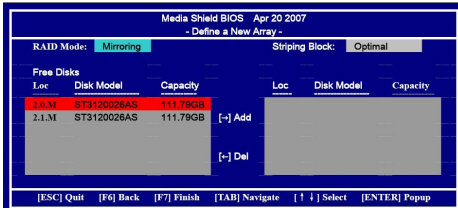

3. In the RAID Mode field, use the UP or Down ARROW key to select a RAID Mode. The supported RAID modes include Mirroring (RAID 1), Striping (RAID 0) and Stripe Mirroring (RAID 0+1), Spanning(JBOD) and RAID 5. The following is an example of RAID 0 array creation.
4. If RAID 0(Striping) is selected, you can manually set the striping block size. in the Stripping Block field, use the UP or DOWN ARROW key to set the Stripping Block size. The KB is standard unit of Stripping Block size. We recommend you leaving it to the default setting-Optimal(64k). The size range is from 4k to 128k.
5. Select the hard drivers which you wish to be included in the disk array. The Free Disks section displays the information about the currently installed SATA hard drives. Press the TAB key to move to the Free Disks section. Select the target hard drives using the UP or DOWN ARROW key and use the RIGHT ARROW key to add the hard drives to the Array Disks section.

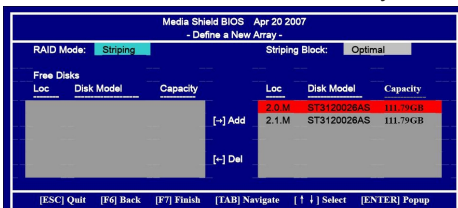

6. Press F7 after selecting the target hard disks. A message which says "Clear disk data?" will appear. If you are sure to clear the data in the selected hard drives, press Y. (If the hard drives contain previously created RAID array, you need to press Y to clear the data from the hard drives.)

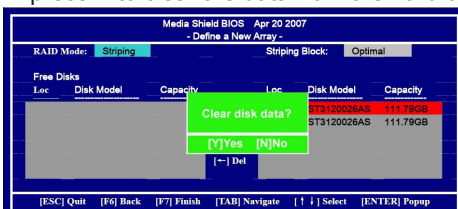

7. After that, then Array List screen displaying the RAID array you created will appear. If you want to set the disk array as boot device, use the UP or DOWN ARROW key to select the array and press B. The Boot section will show Yes.

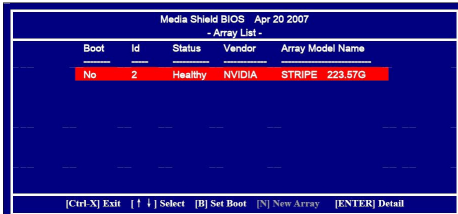

8. To read more information about the RAID array, press ENTER to enter the Array Detail screen, where you should see detailed information about RAID mode, disk block size, disk model name, and disk capacity, etc.

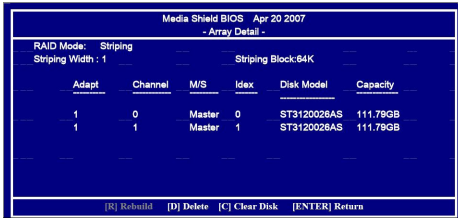

9. To delete the array, press D in the Array Detail screen. When the “Delete this array?” message appears, press Y to confirm or N to cancel. Press ENTER to return to the Array List screen. To exit the Nvidia RAID utility, press ESC in the main menu or Ctrl+X in the Array List screen. Now, you can proceed to install the SATA controller driver and operating system.

Installing the RAID Drivers

1. After you complete the RAID BIOS setup, boot from the windowsXP CD. The Windows Setup program starts.



2. Press F6 and wait a few moments for the Windows Setup screen to appear.

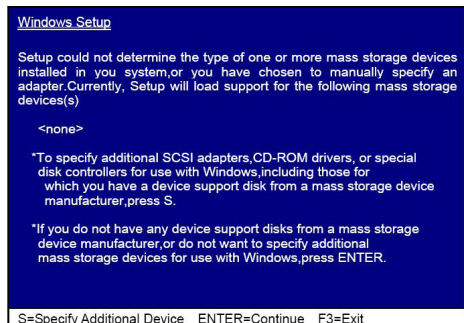

3. Specify the NVIDIA drivers.

(1) Insert the floppy that has the RAID driver, press S, then press Enter.

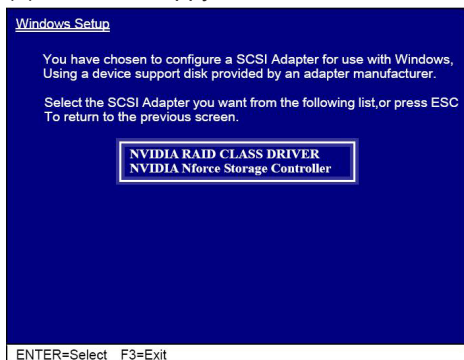

(2) Select “NVIDIA RAID CLASS DRIVER” and then press Enter.

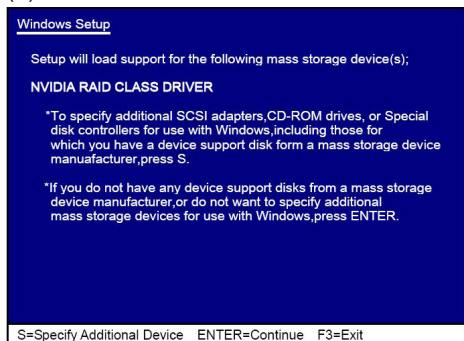

- (3) Press S again at the Specify Devices screen, then press Enter.
- (4) Select "NVIDIA Nforce Storage Controller" and then press Enter.



4. Press Enter to continue with Windows XP Installation.
Be sure to leave the floppy disk inserted in the floppy drive until the blue screen portion of Windows XP installation is completed, then take out the floppy.
5. Follow the instructions on how to install Windows XP.
During the GUI portion of the install you might be prompted to click Yes to install the RAID driver. Click Yes as many times as needed in order to finish the installation. This will not be an issue with a signed driver.

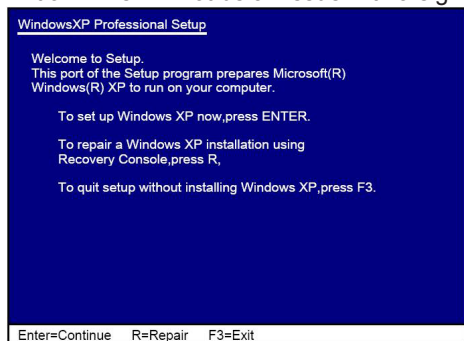

www.zotac.com

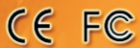

RoHS
Compliant

