



Electronic Emission Notices

Federal Communications Commission (FCC) Statement

This equipment has been tested and found to comply with the limits for a Class B digital device, pursuant to Part 15 of FCC Rules. These limits are designed to provide reasonable protection against harmful interference in a residential installation. This equipment generates, uses and can radiate radio frequency energy and, if not installed and used in accordance with instructions contained in this manual, may cause harmful interference to radio and television communications. However, there is no guarantee that interference will not occur in a particular installation.

If this equipment does cause harmful interference to radio or television reception, which can be determined by turning the equipment off and on, the user is encouraged to try to correct the interference by one or more of the following measures:

- REORIENT OR RELOCATE THE RECEIVING ANTENNA
- INCREASE THE SEPARATION BETWEEN THE EQUIPMENT AND THE RECEIVER
- CONNECT THE EQUIPMENT INTO AN OUTLET ON A CIRCUIT DIFFERENT FROM THAT OF THE RECEIVER
- CONSULT THE DEALER OR AN EXPERIENCED AUDIO/TELEVISION TECHNICIAN

NOTE: Connecting this device to peripheral devices that do not comply with Class B requirements, or using an unshielded peripheral data cable, could also result in harmful interference to radio or television reception.

The user is cautioned that any changes or modifications not expressly approved by the party responsible for compliance could void the user's authority to operate this equipment.

To ensure that the use of this product does not contribute to interference, it is necessary to use shielded I/O cables.

Copyright

This manual is copyrighted with all rights reserved. No portion of this manual may be copied or reproduced by any means.

While every precaution has been taken in the preparation of this manual, no responsibility for errors or omissions is assumed. Neither is any liability assumed for damages resulting from the use of the information contained herein.

Trademarks

All brand names, logos and registered trademarks mentioned are property of their respective owners.

TABLE OF CONTENTS

HARDWARE CONFIGURATION	4
Key Features	4
MOTHERBOARD LAYOUT	7
REAR PANEL	8
AUDIO CONFIGURATION	10
SPEAKER CONFIGURATION	10
Method 1: 4/6 Surround audio output of back panel only	10
Method 2: Using S-Bracket connectors	12
CONNECTORS	14
Floppy Disk Drive Connector: CN3	14
Hard Disk Connectors: CN1 & CN2	14
S-Bracket (SPDIF)/LEN/LFE/Surround Output Connector:	
J19 (optional).....	15
TV Out Connector: J3	16
Chassis Alarm Lead: JP12	17
Fan Power Connectors: CPUFAN1/SYSFAN1.....	18
Power LED: D55/D56.....	18
CD-IN Connector: J18	19
AUX-IN Connector: J20	19
Front Panel Audio Header: FP_S1	20
USB Connectors: FP_U1/FP_U2	21
Front Panel Header: FP1	22
Serial ATA Hard Disk Connectors: SATA1/SATA2	23
JUMPER SETTING	25
JP9 - CMOS Clear	25
JP2 - On Board AC97 Sound Select	25
JP13 - On Board LAN Select	25

SLOTS	26
CPU INSTALLATION	27
INSTALL DDRII DIMMs	31
BIOS SETUP	32
About the Setup Utility	32
The Standard Configuration	32
Entering the Setup Utility	32
Main Menu	33
Standard CMOS Features	34
Advanced BIOS Features	35
Advanced Chipset Features	35
Integrated Peripherals	35
Power Management Setup	35
PNP/PCI Configurations	35
PC Health Status	35
Set Supervisor/User Password	36
Save & Exit Setup	36
Exit Without Saving	36
Flash Update Procedure	37
SATA RAID USER MANUAL	38
Creating RAID Sets	38
Deleting RAID Sets	39
Resolving Conflict	39
DRIVER AND RAID SOFTWARE INSTALLATION	40
Microsoft Windows Driver Installation	40
Install Windows2000/XP	40

HARDWARE CONFIGURATION

Key Features :

Chipset

- ATI® RC410 + SB450 Chipset.

Processor

- Supports Intel® Celeron® , Pentium® 4, Pentium® D processors in the LGA775 -pin package (**with 0.8V~1.6V voltage**).
- Supports 64-bit PSB (Processor System Bus) frequency of 533MHz /800MHz/1066MHz (133MHz/200MHz/266MHz bus clock).
- Supports Hyper-Threading Technology.

VRM 10.0 (Voltage Regulator Modules) on Board

- Flexible motherboard design with on board VRD 10.0, easy to upgrade with future Intel® Celeron, Pentium® 4, Pentium® D processors.
- 0.8375V to 1.600V in 12.5mV steps.

System Memory

- Single-channel (64 bits wide) DDRII operation supported.
- Supports 128Mb, 256Mb, 512Mb technologies implemented as X8, X16 devices.
- Supports DDRII400/DDRII533/DDRII667.
- Support for Non-ECC memory only.
- Maximum memory size: 2GB.

System BIOS

- PnP, APM, ATAPI and Windows® 2000/XP.
- Full support of ACPI & DMI.
- Auto detects and supports LBA harddisks with capacities over 160GB.
- Easy to upgrade BIOS by end-user.

Plug and Play

- Supports Plug and Play specification 1.1.
- Plug and play for Windows® 2000, as well as Windows® XP.
- Fully steerable PCI interrupts.

On-board VGA

- Integrated ATI PCI-E X300 graphic core.
- Supports CRT or TV out display.
- Integrated DAC and CRT controllers.
- Full screen/full speed video playback.
- Up to 2048 x 1536, non-interlaced screen resolution for CRT.

On-board I/O

- Two on board PCI fast IDE ports supporting up to 4 ATA, ATA2 , Ultra ATA33/66/100/133 IDE HDDs, CD-ROMs, ZIP drives and LS-120 drives as boot drive.
- One ECP/EPP parallel port.
- One 16550 Compatible UART serial port.
- One floppy port which supports two FDD of 1.44MB, 2.88MB capacity.
- Eight USB ports (four ports via two headers).
- PS/2 keyboard support.
- PS/2 mouse support.
- One front panel sound connector.
- Infrared (IrDA) support via a header.

Expanded USB Support

- Includes 2 OHCI host controllers, increasing the number of external ports to eight.
- Includes 1 EHCI USB2.0 Host Controller that supports all eight ports (Bandwidth is shared between the eight ports).
- This motherboard support USB 2.0 only on Windows® 2000 (with SP4 or above) and Windows® XP (with SP1 or above) operating systems.

On-board Realtek RTL8100C/RTL8110S PCI LAN (optional)

- Provides 32-bit performance, PCI bus master capability.
- Full compliance with IEEE 802.3u 100 Base-T specifications and IEEE 802.3X Full Duplex Flow Control.
- Supports 10 Mb/s, 100 Mb/s and 1000 Mb/s (only for RTL8110S) operation.
- Supports Wake-On-LAN function and remote wake-up.
- Supports ACPI, PCI Power management and PCI VPD.

TV Out

- Integrated TV encoder.
- 10-bit DAC with 4-tap filter.
- PAL/NTSC TV Out with Composite and S-Video outputs (via a header).
- ATI's exclusive "Composite Dot Crawl" freeze option for PAL and NTSC to improve the picture quality.
- TV-Out power management support.

PCI Express Graphics interface

- One 16-lane (X16 port) PCI Express Graphics port, Fully compliant with the PCI Express Base Specification revision 1.0a.
 - A base PCI Express frequency of 2.5GB/s only.
 - PCI Express support and Enhanced Addressing Mechanism.
-

Power Management

- Supports SMM, APM and ACPI.
- Break switch for instant suspend/resume on system operations.
- Energy star "Green PC" compliant.
- Hardware monitoring circuit provides voltage, fan speed, etc. monitoring (optional).
- External Modem Ring-in Wake-up support.
- Supports suspend-to-RAM (STR) (optional).

Note: Make sure that the current of your 5VSB power supply is more than 1.5A.

Please use a 300 watt power supply or greater.

On-board AC97 Sound

- Integrated AC97 controller with standard AC97 Codec.
- Direct Sound and Sound Blaster compatible.
- Full-Duplex 16-bit record and play back.
- PnP and APM 1.2 support.
- Windows® 2000/XP ready.
- Line-in, Line-out, Mic-in.
- Supports ALC655 AC97 codes for six sound channel output (optional).

On board Serial ATA host Controller (optional)

- Independent DMA operation on two ports.
- Data transfer rates of 150Mb/s.
- RAID feature support .

Expansion Slots

- 1 PCI Express X16 slot.
- 2 PCI slots, - ver. 2.2 compliant.



Static electricity can harm delicate components of the motherboard. To prevent damage caused by static electricity, discharge the static electricity from your body before you touch any of the computers electronic components.

REAR PANEL

The back panel provides the following connectors:

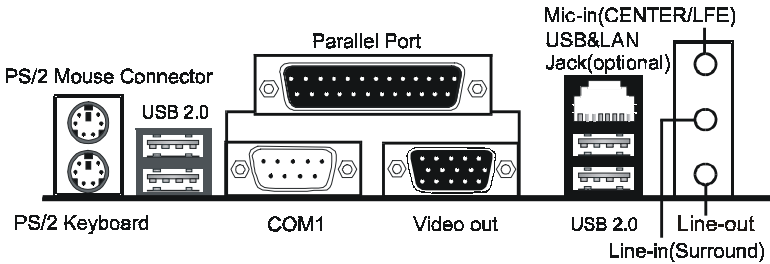

Mouse Connector

The motherboard provides a standard PS/2[®] mouse mini DIN connector for attaching a PS/2[®] mouse. You can plug a PS/2[®] mouse directly into this connector.

Keyboard Connector

The motherboard provides a standard PS/2[®] keyboard mini DIN connector for attaching a PS/2[®] keyboard. You can plug a PS/2[®] keyboard directly into this connector.

USB 2.0 Connector

The motherboard provides an OHCI (Open Host Controller Interface) Universal Serial Bus root for attaching USB devices such as keyboard, mouse or other USB-compatible devices. You can plug the USB device directly into the connector.

USB 2.0 Connector

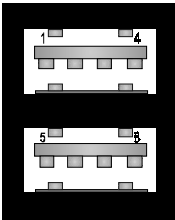

USB 2.0 Connector Description

PIN	SIGNAL	DESCRIPTION
1	VCC	+5V/5VSB (optional)
2	-Data 0	Negative Data Channel 0
3	+Data0	Positive Data Channel 0
4	GND	Ground
5	VCC	+5V/5VSB (optional)
6	-Data 1	Negative Data Channel 1
7	+Data 1	Positive Data Channel 1
8	GND	Ground

Serial Port Connectors: COM1

The Port is 16550A high speed communication port that send/receive 16 bytes FIFOs. You can attach a serial mouse or other serial devices directly to the connectors.

Video Out Connector

The motherboard provides a Video out port to connect a 15-pin analog video monitor.

LAN Jack

The motherboard provides one standard RJ-45 jack for connecting to a Local Area Network (LAN). You can connect a network cable to the LAN jack.

Parallel Port Connector: LPT1

The motherboard provides a 25-pin female centronic connector. A parallel port is a standard printer port that supports Enhanced Parallel Port (EPP) and Extended Capabilities Parallel Port (ECP) mode.

Audio Port Connector

Line_Out is a connector for Speakers or Headphones. **Line_In** is used for external CD player, tape players, or other audio devices. **Mic_In** is the microphone connector.

The ALC655 embeds an internal analog switch (by driver software) to select LINE input or Surround output, and to select MIC input or CENTER/LFE output.

AUDIO CONFIGURATION

After installing the audio driver, you can select 2/4/6 channel surround audio output in the software utility and then connect surround speakers to appropriate audio ports.

There are two ways to obtain 2/4/6 channel surround audio output:

1. Using the 4/6 surround audio output of the back panel only. All surround speaker connect to this audio connector.
2. Using the S-Bracket (optional cable). You have installed the S-Bracket into the computer. Connect two front speakers to back panel's "Line Out" port, and the rest of speakers to S-Bracket. For connection details, please refer to page 15.

SPEAKER CONFIGURATION

Method 1: 4/6 Surround audio output of back panel only.

After installing the audio drivers, you can attach the speakers for 2-/4-/6-channel audio output. Always connect the speakers to the LINE OUT connectors. Different connector configurations for 2-/4-/6-channel operations are listed below:

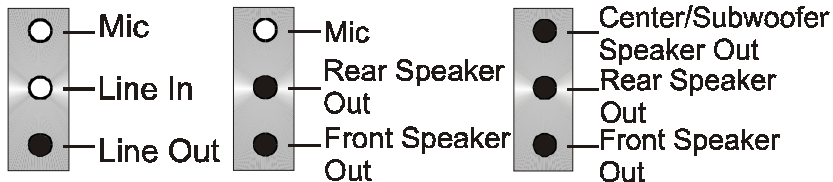

2-Channel

In 2-channel configuration, Line Out, Line In and MIC functions all exist.

4-Channel

When set to 4-channel configuration, Line In is replaced by Rear Speaker Out. The Line in function does not exist.

6-Channel

When set to 6-channel configuration, Line In is replaced by Rear Speaker Out. Mic is replaced by Center/Subwoofer Speaker Out. Line in and Mic functions do not exist.

In the software utility, double click “AC97 Audio configuration” icon  from the window tray on the right bottom.

The “AC97 Audio Configuration” box will appear. Click on the **Speaker Configuration** tab to select the audio mode.

A. When you choose 4-channel mode for 4 speaker output, the selected item is shown (Figure1).

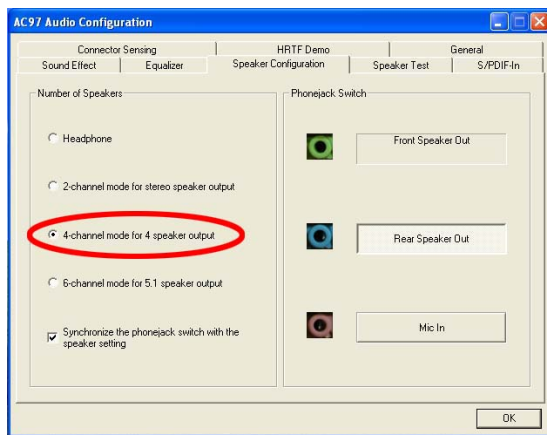

(Figure1)

B. When you choose 6-channel mode for 5.1 speaker output, the selected item is shown (Figure2)

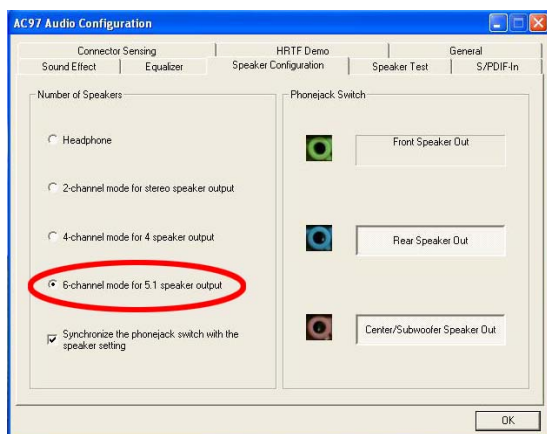

(Figure2)

Method 2: Using S-BRACKET connectors:

The S-Bracket (shown on page 15) is an optional accessory. It gives access to analog and digital audio output by integrating both SPDIF and analog LINE OUT connectors. To use the S-Bracket, you should select the correct settings in the software utility. For information about the setting, refer to selecting 4- or 6- Channel Settings later in the section.

Connector configurations for 4- and 6- channel using S-Bracket are described below:

4-Channel Analog Audio Output

Back Panel

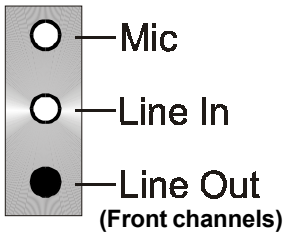

S-Bracket

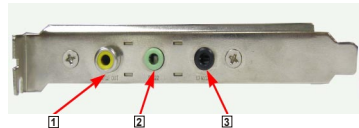

- [1] SPDIF jack (coaxial)
- [2] Rear Speaker Out
- [3] No function

Description:

Connect two speakers to the back panel's Line Out connector and two speakers to one Line Out connector on the S-Bracket, or connect all four speakers to one connector on the S-Bracket. If you want to use the **Line In** function, please click the **Rear Speaker Out** button (shown below).



6-Channel Analog Audio Output

Back Panel

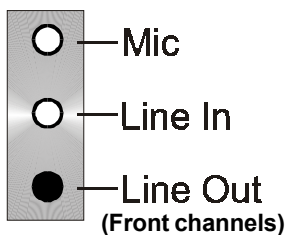

S-Bracket

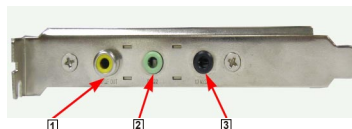

- 1 SPDIF jack (coaxial)
- 2 Rear Speaker Out
- 3 Center and Subwoofer Out

Description:

Connect two speakers to back panel's Line Out connector and four speakers to the Line Out connector of the S-Bracket, or attach all six speakers to the connector on the S-Bracket. If you want to use the **Line In** and **MIC** functions at the same time, please click the **Rear Speaker Out** and **Center/Subwoofer Speaker Out** buttons (shown below).

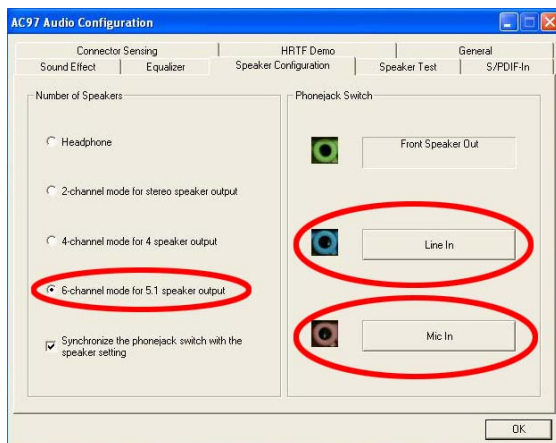

CONNECTORS

The motherboard provides connectors to connect to the FDD, IDE HDD, and USB Ports and to the CPU/System FAN etc.

Floppy Disk Drive Connector: CN3

The motherboard provides a standard floppy disk drive connector that supports 1.44M, 2.88M floppy disk types.

Hard Disk Connectors: CN1&CN2

The motherboard has a 32-bit Enhanced PCI IDE and Ultra DMA 33/66/100/133 controller that provides PIO mode 0~4, Bus Master, and Ultra DMA 33/66/100/133 function. You can connect up to four hard disk drives, CD-ROMs, 120MB

Floppy (reserved for future BIOS) and other devices.

CN1 (Primary IDE Connector)

The first hard drive should always be connected to CN1. CN1 can connect a Master and a Slave drive. You must configure the second hard drive to Slave mode by setting the jumper accordingly.

CN2 (Secondary IDE Connector)

CN2 can also connect a Master and a Slave drive.

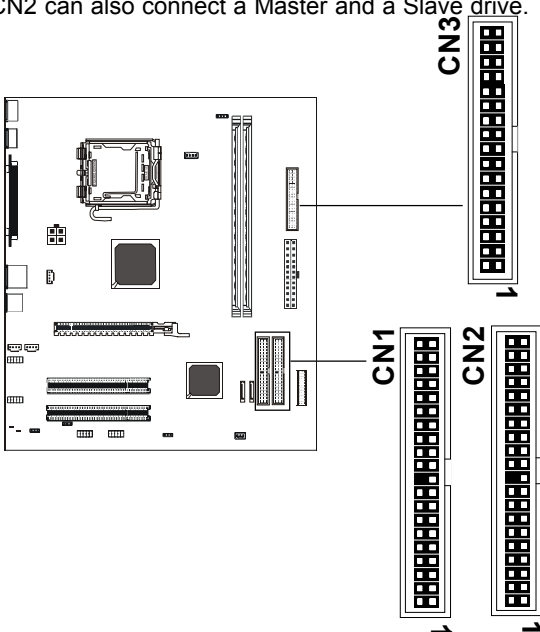

S-Bracket (SPDIF)/CEN/LFE/Surround Output Connector: J19 (optional)

The connector allows you to connect a S-Bracket for a Digital Interface (SPDIF). The S-Bracket offers 1 SPDIF jacks for digital audio transmission and 2 analog Line-Out jacks for other 4-channel audio output. So you can use Line in, Mic in and 6 channel audio output features at the same time.

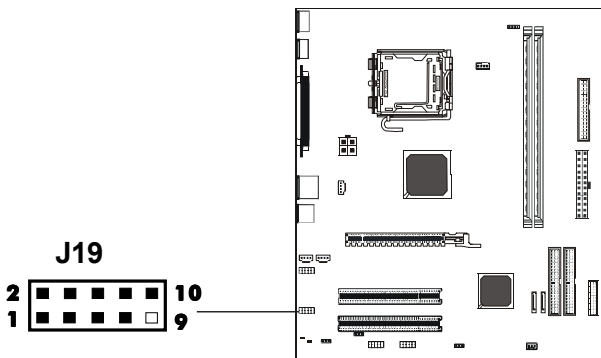

PIN	SIGNAL	DESCRIPTION
1	SOUT-L	Audio left surrounding output
2	SOUT-R	Audio right surrounding output
3	GND	Ground
4	GND	Ground
5	CET-OUT	Audio center output
6	LFE-OUT	Audio bass output
7	GND	Ground
8	SPDIF	S/PDIF input
9	KEY	NC
10	SPDFO	S/PDIF output

S-Bracket Cable (optional)

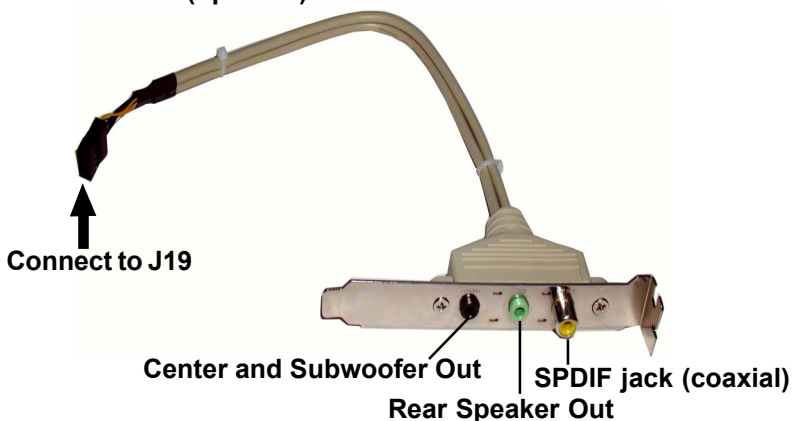

TV Out Connector

The motherboard provides TV Out connector.

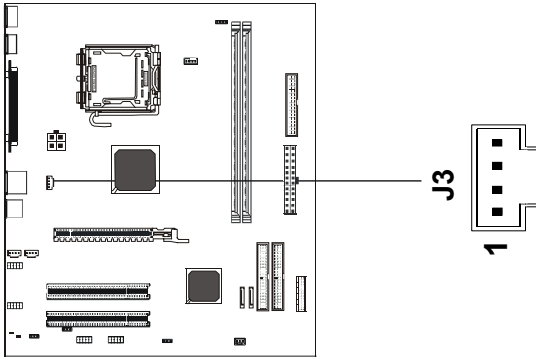

J3 : TV Out

PIN	Assignment
1	C
2	GND
3	COMP/B
4	Y

TV Out cable



Chassis Alarm Lead: JP12 (optional)

This lead is for a chassis designed with an intrusion detection feature. This requires an external detection mechanism such as a chassis intrusion sensor or microswitch. When you remove any chassis component, the sensor triggers and sends a high-level signal to this lead to record a chassis intrusion event.

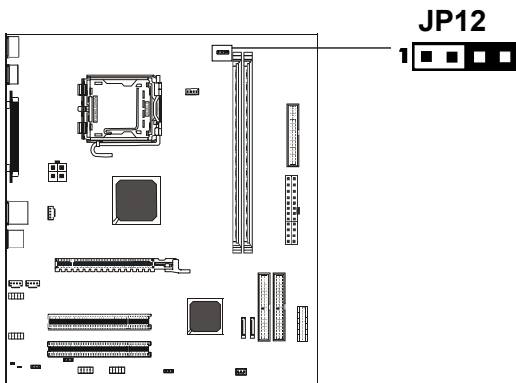

JP12 Pin Definition

PIN	Assignment
1	+5VSB
2	KEY
3	Chassis Signal
4	GND

Note:

If you want to use “Chassis Alarm” Connector, you must remove 3-4 jumper.

Fan Power Connectors: CPUFAN1/SYSFAN1

The CPUFAN1 (processor fan) and SYSFAN1 (system fan) support system cooling fans using +12V via a four/three-pin head connector. When connecting the wire to the connectors, always take note that the red wire is the positive and should be connected to the +12V, the black wire is Ground and should be connected to GND. If the motherboard has a System Hardware Monitor chipset on-board, you must use a specially designed fan with speed sensor to take advantage of the CPU fan control.

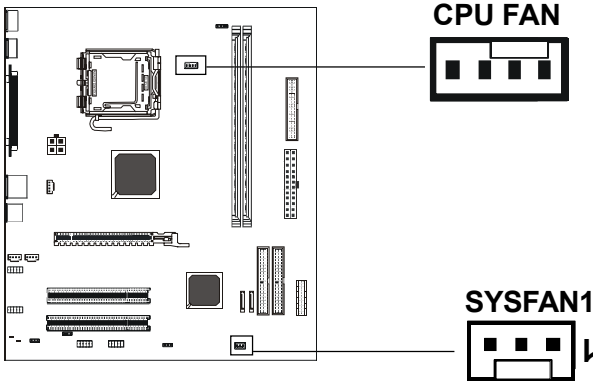

Power LED: D55/D56 (optional)

The green LED lights when the system is in the power-on state.

The red LED lights whenever AC power is attached, irrespective of whether the system is powered-on, powered-off or in standby mode.

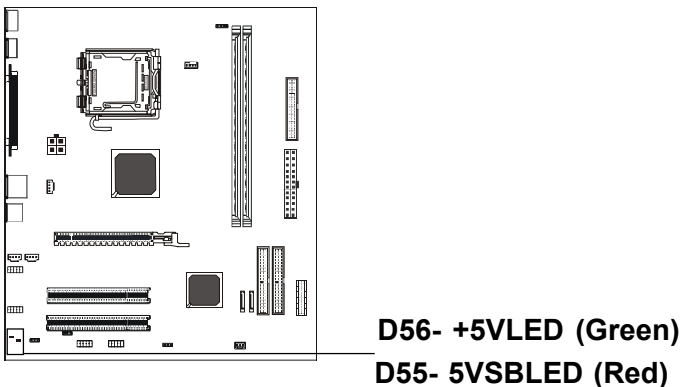

CD-IN Connector: J18

The connector is for CD-ROM Drive.

AUX-IN Connector: J20

The connector is for Audio Device.

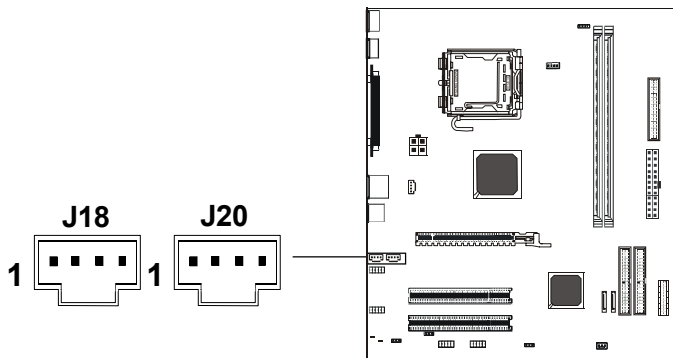
**CDS1 : J18**

PIN	Assignment
1	CD-L
2	GND
3	GND
4	CD-R

AUX1 : J20

PIN	Assignment
1	AUX-L
2	GND
3	GND
4	AUX-R

Front Panel Audio Header: FP-S1

This motherboard supports front panel microphone and speaker out ports. If your computer case has these ports, connect them to FP-S1.

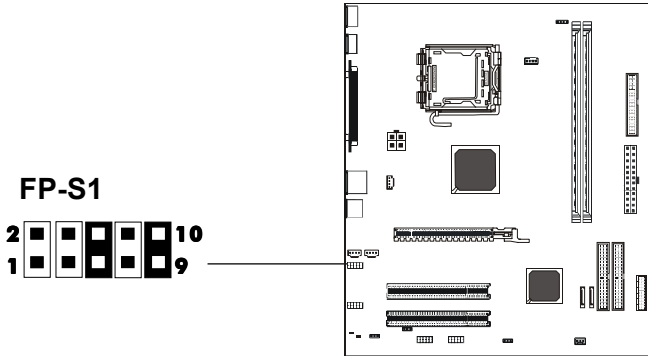

FP-S1

PIN	Assignment
1	MIC
2	GND
3	REF
4	POWER
5	Front Audio(R)
6	Rear Audio(R)
7	Reserved
8	Key(No pin)
9	Front Audio(L)
10	Rear Audio(L)

Note:

If you want to use the "Front Audio" connector, you must remove 5-6, 9-10 pin jumpers. In order to utilize the front audio header, your chassis must have front audio connector. Also please make sure the pin assignment on the cable is the same as the pin assignment on the MB header. To find out if the chassis you are buying supports a front audio connector, please contract your dealer.

USB Connector: FP-U1/FP-U2

This motherboard has USB ports. Some computer cases have a special module that mounts USB ports at the front of the case. If you have this kind of case, use the auxiliary USB connector FP_U1/FP_U2 to connect the front mounted ports to the motherboard.

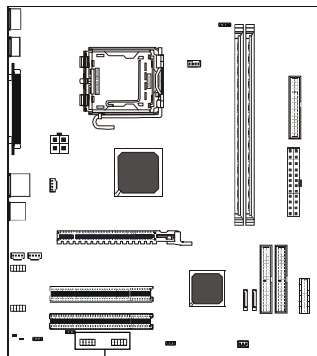

USB Connector

PIN	Assignment
1	VCC
2	VCC
3	USBP0-
4	USBP1-
5	USBP0+
6	USBP1+
7	GND
8	GND
9	KEY
10	OC#

Front Panel Header: FP1

The motherboard provides one front panel connector for the front panel switches and LEDs.

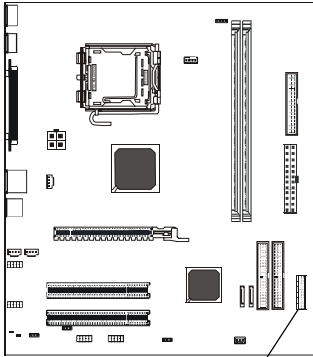

FP1

	24	■ ■	23	VCC
GND	22	■ ■	21	GND
KEYLOCK	20	□ ■	19	NC
KEY	18	□ ■	17	SPEAKER
KEY	16	■ ■	15	IRTX
IRRX	14	■ ■	13	VCC
GND	12	□ ■	11	NC
KEY	10	□ ■	9	NC
KEY	8	■ ■	7	RESET
GND	6	■ ■	5	GND
PWR_SW	4	■ ■	3	HDD_LED-
PW_LED-	2	■ ■	1	HDD_LED+
PW_LED+				

Serial ATA Hard Disk Connectors: SATA1/SATA2 (optional)

The motherboard has two SATA connectors. The motherboard provides optional dual high-speed Serial ATA interface ports SATA1&SATA2. Each supports 1st generation serial ATA data rates of 150 MB/s. All connector types are fully compliant with Serial ATA 1.0 specifications. Each Serial ATA connector can connect to 1 hard disk device. Please refer to Serial ATA Raid manual for detail software installation procedure.

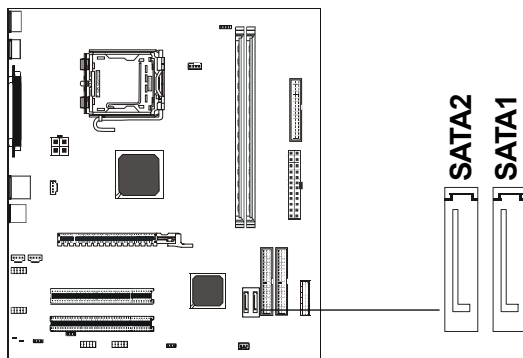

PIN	SIGNAL
1	GND
2	TXP
3	TXN
4	GND
5	RXN
6	RXP
7	GND

Serial ATA Cable



Connect one end of the SATA cable to the motherboard, and connect the other end to the SATA Hard Disk.



Please do not fold the serial ATA cable at a 90-degree angle as this will cause a loss of data during the transmission.

Serial ATA Hard Disk Devices Power Cable (optional)

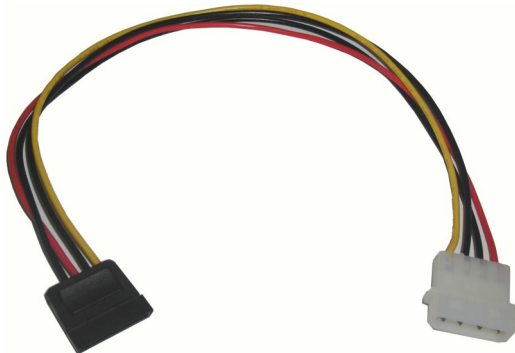

JUMPER SETTING

This chapter explains how to configure the motherboard's hardware. Before using your computer, make sure all jumpers and DRAM modules are set correctly. Refer to this chapter whenever in doubt.

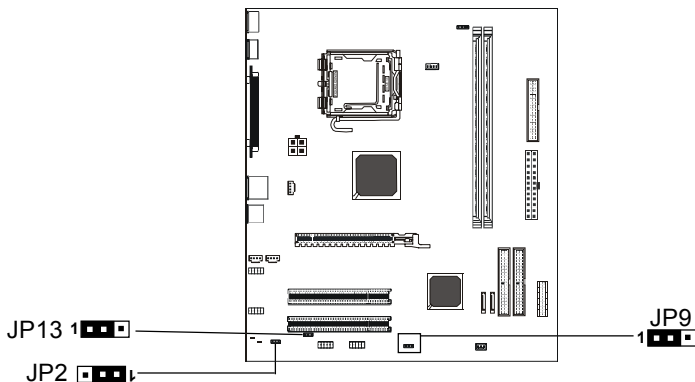

Clear CMOS Jumper: JP9

If you want to clear the system configuration, use the JP9 (Clear CMOS Jumper) to clear data.

JP9	Selection
1-2-3	Normal*
1-2-3	CMOS Clear

JP2-On Board AC97 Sound Select

JP2	Function
1-2-3	AC97 Sound Enable*
1-2-3	AC97 Sound Disable

JP13-On Board LAN Select (optional)

JP13	Function
1-2-3	LAN Enable*
1-2-3	LAN Disable

Close
 Open
 * = Default setting.

SLOTS

The motherboard provides one PCI-E X16 slot and two 32-bit PCI slots.

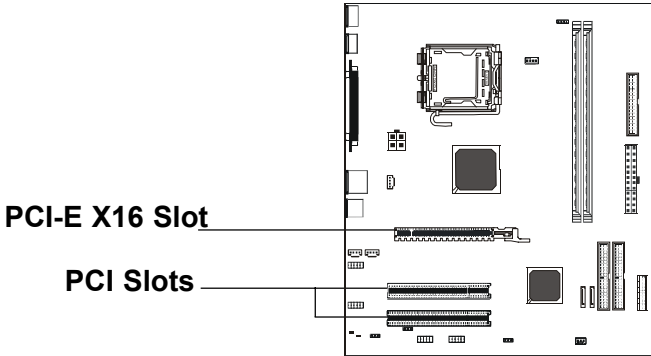

PCI (Peripheral Component Interconnect) Slots

The PCI slots allow you to insert expansion cards to meet your needs. When adding or removing expansion cards, make sure that you unplug the power supply first. Read the documentation for the expansion card and make any necessary hardware or software settings for the expansion card, such as jumpers, switches or BIOS configuration.

CPU INSTALLATION

Please follow the steps below to install the CPU.

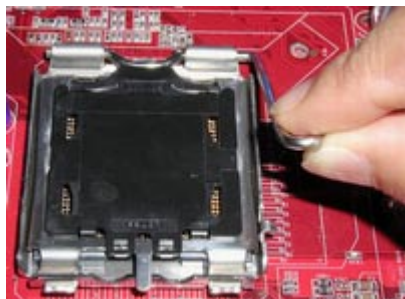

1. Use index finger and thumb to move metal lever so it is separated from the bottom steel shell grip hook.

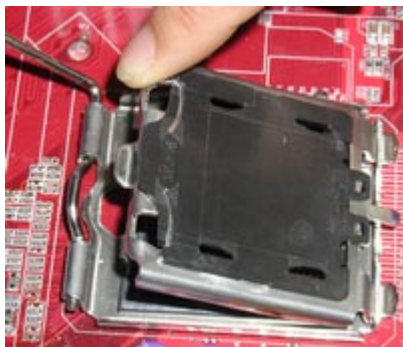

2. Use index finger to lift the top steel shell.



3. Use index finger and thumb to place the CPU onto the plastic body (look for the gold arrow on the CPU. The gold arrow should point away from the lever pivot).



4. Use index finger and thumb to press down metal lever, the cap will be pushed up by the CPU; this may also be done by removing the cap beforehand.



5. Press the metal lever so it is secured in the bottom steel shell grip hook.

6. It's recommended that the CPU heatsink be approved by Intel for use with the Prescott CPU. Choose the orientation of the thermal solution for optimal wire routing to the fan header on the motherboard. Position the thermal solution over the processor. Ensure the fan wiring is positioned to prevent wire pinching between the heatsink and the processor, or between the heatsink clip and the socket.



7. Align the fastener tips with the motherboard hole pattern, insert the fastener tips into the holes, guiding the wires to avoid pinching. The fasteners will slide through the motherboard holes with no insertion force.



8. Engage the fasteners caps. Apply thumb pressure to the top of each of the 4 fastener caps, there is no specific order of engagement, you will hear a "click" upon full engagement.



9. Gently rotate the cap clockwise 1/4 turn.



10. At last, attach the fan wire connector to the 4 pin fan header connector on the motherboard labeled CPU FAN.

Install DDRII DIMMs

Please follow the steps below to install DDRII DIMMs.

1. Locate the DDRII DIMM sockets.
2. Holding the DDRII DIMM by the edges, remove it from its antistatic package.
3. Make sure the clips at either end of the socket are pushed away from the socket.

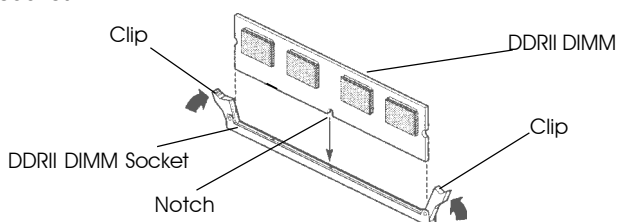

4. Position the DDRII DIMM above the socket. Align the middle notch in the bottom edge of the DDRII DIMM with the key in the socket.
5. Insert the bottom edge of the DDRII DIMM into the socket.
6. When the DDRII DIMM is seated, push down on the top edge of the DDR II DIMM until the retaining clips at the ends of the socket snap into place.

Note: Please turn the system off before installing or removing any device, otherwise system damage can occur.

BIOS SETUP

About the Setup Utility

The motherboard uses the latest Award BIOS with support for Windows Plug and Play. The CMOS chip on the motherboard contains the ROM setup instructions for configuring the motherboard BIOS.

The BIOS (Basic Input and Output System) Setup Utility displays the system's configuration status and provides you with options to set system parameters. The parameters are stored in battery-backed-up CMOS RAM that saves this information when the power is turned off. When the system is turned back on, the system is configured with the values you stored in CMOS.

The BIOS Setup Utility enables you to configure:

- Hard drives, diskette drives and peripherals**
- Video display type and display options**
- Password protection to prevent unauthorized use**
- Power Management features**

The settings made in the Setup Utility affect how the computer performs. Before using the Setup Utility, ensure that you understand the Setup Utility options.

This chapter provides explanations for Setup Utility options.

The Standard Configuration

A standard configuration has already been set in the Setup Utility. However, we recommend that you read this chapter in case you need to make any changes in the future.

This Setup Utility should be used:

- when changing the system configuration
- when a configuration error is detected and you are prompted to make changes to the Setup Utility
- when trying to resolve IRQ conflicts
- when making changes to the Power Management configuration
- when changing the password or making other changes to the Security Setup

Entering the Setup Utility

When you power on the system, BIOS enters the Power-On Self Test (POST) routines. POST is a series of built-in diagnostics performed by the BIOS. After the POST routines are completed, the following message appears:

Main Menu

Once you enter the Award BIOS CMOS Setup Utility, the Main Menu will appear on the screen. The Main Menu allows you to select from various setup functions and two exit choices. Use the arrow keys to select among the items and press <Enter> to accept and enter the sub-menu.

Phoenix - Award Workstation BIOS CMOS Setup Utility

<ul style="list-style-type: none"> ▶ Standard CMOS Features ▶ Advanced BIOS Features ▶ Advanced Chipset Features ▶ Integrated Peripherals ▶ Power Management Setup ▶ PnP/PCI Configurations ▶ PC Health Status 	<ul style="list-style-type: none"> ▶ Frequency/Voltage Control ▶ Load Fail-Safe Defaults ▶ Load Optimized Defaults ▶ Set Supervisor Password ▶ Set User Password ▶ Save & Exit Setup ▶ Exit Without Saving
<p>Esc : Quit ↑↓→← : Select Item F10 : Save & Exit Setup</p>	
<p>Time, Date, Hard Disk Type</p>	

(Note : The sample BIOS Setup Menu included here only shows a typical case, and may not be exactly the same as the one on your unit.)

Note that a brief description of each highlighted item will appear at the bottom of the screen.

Standard CMOS Features This setup page includes all the items of Award™ special standard features.

Advanced BIOS Features This setup page includes all the items of Award™ special enhanced features.

Advanced Chipset Features This setup page includes all the items of chipset special features.

Integrated Peripherals This section page includes all the items of IDE hard drive and Programmed Input / Output features.

Power Management Setup This entry only appears if your system supports Power Management "Green PC" standards.

PNP/PCI Configurations This entry appears if your system supports PNP/PCI.

PC Health Status Display CPU and Case Fan Speed etc.

Frequency/Voltage Control CPU speed setting are settings of CPU speed. You should refer to your CPU marking.

Load Fail-Safe Defaults The BIOS defaults that have been set by the manufacturer and represent settings which provide the minimum requirements for your system to operate.

Load Optimized Defaults These chipset defaults are settings which provide for maximum system performance. While Award has designed the custom BIOS to maximize performance, the manufacturer has the right to change these defaults to meet their needs.

Set Supervisor/ User Password Changes, sets, or disables password. It allows you to limit access to the system and the Setup Program.

Save & Exit Setup Saves value changes to CMOS and exits setup.

Exit Without Saving Abandons all CMOS value changes and exits setup.

Standard CMOS Features

The items in Standard CMOS Setup Menu are divided into 10 categories. Each category includes one or more setup items. Use the arrow keys to highlight the item and then use the <PgUp> or <PgDn> key to select the desired value in each item.

Phoenix - Award Workstation BIOS CMOS Setup Utility
Standard CMOS Features

Date (mm :d d :yy)	Sat. Jan 01 2005	Item Help
Time (h h :mm:ss)	11 : 1 : 35	
▶ IDE Primary Master	[Press Enter 4303 MB]	Menu Level ▶
▶ IDE Primary Slave	[None]	Change the day, month, year and century
▶ IDE Secondary Master	[None]	
▶ IDE Secondary Slave	[None]	
Drive A	[1.44M, 3.5 in.]	
Drive B	[None]	
Video	[EGA/VGA]	
Halt on	[All, but keyboard]	
Base Memory	640K	
Extended Memory	30720K	
Total Memory	31744K	

↑↓→← Move Enter: Select +/-/PU/PD : Value F10 : Save ESC : Exit F1 :General Help
F5 : Previous Values F6 : Fail-Safe Defaults F7 : Optimized Defaults

(Note : The sample BIOS Setup Menu included here only shows a typical case, and may not be exactly the same as the one on your unit.)

Date	The date format is <day-of-the-week>. <month> <day> <year>.
Time	The time format is <hour> <Minute> <second> displayed in 24-hour military-time clock. For example, 1 p. m. is displayed as 13:00:00.
Primary Master/Primary Slave/Secondary Master/Secondary	These categories identify the types of the two channels that have been installed in the computer. If the controller of the HDD interface is SCSI, the selection shall be "None".
Drive A Type / Drive B Type	This category identifies the drive types which have been installed in the computer.
Video	The default setting is EGA/VGA.
Halt on	You can select which type of error will cause the system to halt.

Advanced BIOS Features

This section allows you to configure your system for basic operation. You have the opportunity to select the system's default speed, boot-up sequence, keyboard operation, shadowing and security.

Advanced Chipset Features

The Chipset Features Setup option is used to change the values of the chipset registers. These registers control most of the system options in the computer.

This section allows you to configure the system based on the specific features of the installed chipset. This chipset manages bus speeds and access to system memory resources, such as DRAM and the external cache. It must be stated that these items should not be altered. The default settings have been chosen because they provide the best operating conditions for your system.

Integrated Peripherals

The Integrated Peripherals Setup allows the user to configure the onboard IDE controller, floppy disk controller, the printer port and the serial ports.

Power Management Setup

The Power Management Setup Menu allows you to configure your system to save the most energy while operating in a manner consistent with your own style of computer use.

PNP/PCI Configurations

This section describes how to configure the PCI bus system. This section covers some very technical items and it is recommended that only experienced users should make any changes to the default settings.

PC Health Status

The PC Health Status displays CPU and Case Fan Speed.

Set Supervisor/User Password

When this function is selected, the following message appears at the center of the screen to assist you in creating a password.

ENTER PASSWORD

Type the password, up to eight characters, and press <Enter>. The password typed now will clear any previously entered password from CMOS memory. You will be asked to confirm the password. Type the password again and press <Enter>. You may also press <Esc> to abort the selection. To disable password, just press <Enter> when you are prompted to enter password. A message will confirm the password being disabled. Once the password is disabled, the system will boot and you can enter BIOS Setup freely.

PASSWORD DISABLED

If you have selected "**System**" in "Security Option" of "BIOS Features Setup" menu, you will be prompted for the password every time the system reboots or any time you try to enter BIOS Setup. If you have selected "**Setup**" at "Security Option" from "BIOS Features Setup" menu, you will be prompted for the password only when you enter BIOS Setup.

Supervisor Password has higher priority than User Password. You can use Supervisor Password when booting the system or entering BIOS Setup to modify all settings. Also you can use User Password when booting the system or entering BIOS Setup but can not modify any setting if Supervisor Password is enabled.

Save & Exit Setup

Navigate to this option and press <Enter> to save the changes that you have made in the Setup Utility and exit the Setup Utility. When the Save and Exit dialog box appears, press <Y> to save and exit, or press <N> to return to the main menu.

Exit Without Saving

Navigate to this option and press <Enter> to discard any changes that you have made in the Setup Utility and exit the Setup Utility. When the Exit Without Saving dialog box appears, press <Y> to discard changes and exit, or press <N> to return to the main menu.

Note: If you have made settings that you do not want to save, use the "Exit Without Saving" item and press <Y> to discard any changes you have

FLASH Update Procedure

The program AWDFLASH.EXE is included on the driver CD (D:\Utility\AWDFLASH.EXE). Please follow the recommended procedure to update the flash BIOS, as listed below.

1. Create a DOS-bootable floppy diskette. Copy the new BIOS file (just obtained or downloaded) and the utility program AWDFLASH.EXE to the diskette.
2. Allow the PC system to boot from the DOS diskette.
3. At the DOS prompt, type

AWDFLASH<ENTER>

4. Enter the file name of the new BIOS.
5. The question: "Do you want to save BIOS (Y/N)?" is displayed.

***Press "N" if there is no need to save the existing BIOS.
Press "Y" if a backup copy of the existing BIOS is needed.
(A file name has to be assigned to the existing BIOS binary file.)***

6. The message : "Press "Y" to program or "N" to exit" is displayed. Type

"Y"<ENTER>

7. Wait until the flash-update is completed.
8. Restart the PC.

<p>Warning : - Do not turn off or RESET the computer during the flash process. - If you are not sure how to upgrade the BIOS, please take your computer to an Authorized Service Center and have a trained technician do the work for you.</p>

SATA RAID USER MANUAL

Creating and deleting RAID sets is a function found in the BIOS. During bootup, the following message will appear, pausing for a few moments to allow the user to choose what to do:

Press Ctrl+S or F4 to enter RAID utility

An easy-to-use screen will appear with the following choices in the top left:

Create RAID Set
Delete RAID Set
Rebuild RAID Set
Resolve Conflicts

Below this will be listed the drives currently installed on the system.

The top right half of the screen displays directions and comments for the user. The bottom right half lists the command keys:

Arrows up and down are Select Keys
ESC takes the user to the previous menu
Enter selects the user's choice
Ctrl-E exits the utility

Creating RAID Sets

Because SATA Raid supports two drives, creating RAID Sets is a simple procedure.

1. Select "Create RAID Set."
2. Choose either a "Striped" or "Mirrored" RAID Set.
3. Select if you want the utility to Auto Configure the RAID Set or if you want to manually configure the RAID Set. For Striped Sets, you can change the chunk size. For Mirrored Sets, you assign which is the Source and Target drives, as well as if you want Disk Copy.

What is Disk Copy? If the disk assigned as the source disk has already been partitioned and has data stored on it, and then a second disk is added for redundancy, the data on the source drive can be copied to the destination drive, so that the disks are identical, and all subsequent data will be written to both drives as a Mirrored set. If, however, the source disk does not have data already stored on it, there is no need for Disk Copy.

4. The utility will ask "Are You Sure?" before completing the configuration.

Deleting RAID Sets

1. To remove one or more RAID sets, select "Delete RAID Set."
2. Select desired set and press Y when asked "Are You Sure?"

Resolving Conflict

When a RAID set is created, the metadata written to the disk includes drive connection information (Primary Channel, Secondary Channel). If, after a disk failure, the replacement disk was previously part of a RAID set (or used in another system), it may have conflicting metadata, specifically in reference to the drive connection information. If so, this will prohibit the RAID set from being either created or rebuilt. In order for the RAID set to function properly, this old metadata must be first overwritten with the new metadata. To resolve this, select "Resolve Conflict" and the correct metadata, including the correct drive connection information, will be written to the replacement disk.

DRIVER AND RAID SOFTWARE INSTALLATION

Microsoft Windows Driver Installation

1. After Windows has finished booting up, the system will automatically find the newly installed adapter and prompt the **Found New Hardware Wizard** window. Click **Cancel** to skip it.



2. Insert the bundled driver CD into your CD-ROM drive and select “**ATI Chipset\ATI_Raid Driver**” installation bar on the dialogue window to begin the driver and software installation (Please follow the instructions to finish the installation).

Install Windows2000/XP

- a. Insert the bundled driver CD DISC into CD-ROM(G:). Copy all files from the directory (G:\ATI chipset\ATI_Raid) to a floppy disk.
- b. Install the OS from CD-ROM.
- c. Press “**F6**” at the prompt “Press **F6** if you need to install a third party SCSI or RAID driver...”.
- d. Insert the floppy disk.
- e. Choose the OS device driver to be loaded.
- f. Install the OS.
- g. Install the driver after OS is installed.

Note to User:

The bundled driver CD contains all the drivers that the motherboard needs. Each driver will install automatically once it is selected. Please select the drivers that you want to install by clicking on the driver’s button.