



## Electronic Emission Notices

### Federal Communications Commission (FCC) Statement

This equipment has been tested and found to comply with the limits for a Class B digital device, pursuant to Part 15 of FCC Rules. These limits are designed to provide reasonable protection against harmful interference in a residential installation. This equipment generates, uses and can radiate radio frequency energy and, if not installed and used in accordance with instructions contained in this manual, may cause harmful interference to radio and television communications. However, there is no guarantee that interference will not occur in a particular installation.

If this equipment does cause harmful interference to radio or television reception, which can be determined by turning the equipment off and on, the user is encouraged to try to correct the interference by one or more of the following measures:

- REORIENT OR RELOCATE THE RECEIVING ANTENNA
- INCREASE THE SEPARATION BETWEEN THE EQUIPMENT AND THE RECEIVER
- CONNECT THE EQUIPMENT INTO AN OUTLET ON A CIRCUIT DIFFERENT FROM THAT OF THE RECEIVER
- CONSULT THE DEALER OR AN EXPERIENCED AUDIO/TELEVISION TECHNICIAN

**NOTE:** Connecting this device to peripheral devices that do not comply with Class B requirements, or using an unshielded peripheral data cable, could also result in harmful interference to radio or television reception.

The user is cautioned that any changes or modifications not expressly approved by the party responsible for compliance could void the user's authority to operate this equipment.

To ensure that the use of this product does not contribute to interference, it is necessary to use shielded I/O cables.

### Copyright

This manual is copyrighted with all rights reserved. No portion of this manual may be copied or reproduced by any means.

While every precaution has been taken in the preparation of this manual, no responsibility for errors or omissions is assumed. Neither is any liability assumed for damages resulting from the use of the information contained herein.

### Trademarks

All brand names, logos and registered trademarks mentioned are property of their respective owners.

---

## TABLE OF CONTENTS

<b>HARDWARE CONFIGURATION .....</b>	<b>4</b>
Key Features .....	4
<b>MOTHERBOARD LAYOUT .....</b>	<b>7</b>
<b>REAR PANEL .....</b>	<b>8</b>
<b>AUDIO CONFIGURATION .....</b>	<b>10</b>
<b>SPEAKER CONFIGURATION .....</b>	<b>10</b>
Method 1: 2/4/6 channel audio output on back panel only .....	10
Method 2: Using S-Bracket connectors .....	12
<b>CONNECTORS .....</b>	<b>14</b>
Floppy Disk Drive Connector: CN3 .....	14
Hard Disk Connectors: CN1&CN2 .....	14
Back Panel Bracket-Six Channel Audio Output Connector: J19 .....	15
TV Out Connector: J5 .....	16
IEEE1394 Connector: J23 .....	17
Chassis Alarm Lead: JP12 .....	18
Fan Power Connectors: CPUFAN1/SYSFAN1.....	19
Power LED: D55/D56.....	19
CD-IN Connector: J18 .....	20
AUX-IN Connector: J20 .....	20
Front Panel Audio Header: FP_S1 .....	21
USB Connectors: FP_U1/FP_U2 .....	22
Front Panel Headers: FP1 .....	23
Serial ATA Hard Disk Connectors: SATA1/SATA2/SATA3/SATA4 .....	24
<b>JUMPER SETTING .....</b>	<b>26</b>
JP9-CMOS Clear .....	26
JP2-On Board AC97 Sound Select .....	26
JP13-On Board LAN Select .....	26
JP3-On Board IEEE1394 Select .....	26

<b>SLOTS .....</b>	<b>27</b>
<b>CPU INSTALLATION .....</b>	<b>28</b>
<b>INSTALL DDR DIMMS .....</b>	<b>31</b>
<b>BIOS SETUP .....</b>	<b>32</b>
About the Setup Utility .....	32
The Standard Configuration .....	32
Entering the Setup Utility .....	32
Main Menu .....	33
Standard CMOS Features .....	34
Advanced BIOS Features .....	35
Advanced Chipset Features .....	35
Integrated Peripherals .....	35
Power Management Setup .....	35
PNP/PCI Configurations .....	35
PC Health Status .....	35
Set Supervisor/User Password .....	36
Save & Exit Setup .....	36
Exit Without Saving .....	36
Flash Update Procedure .....	37
<b>SATA RAID USER MANUAL .....</b>	<b>38</b>
Creating RAID Sets .....	38
Deleting RAID Sets .....	38
Resolving Conflict .....	38
<b>DRIVER AND RAID SOFTWARE INSTALLATION .....</b>	<b>39</b>
Microsoft Windows Driver Installation .....	39
Install Windows 2000/XP .....	39
<b>APPENDIX .....</b>	<b>40</b>

---

## HARDWARE CONFIGURATION

### KEY FEATURES :

#### Chipset

- ATI® RS482/RX482/RS480/RX480+SB450/SB400 Chipset.

#### Processor

- Support for AMD™ K8 Processor in a Socket 754 package.
- Support Hypertransport interface bus.

#### VRM (Voltage Regulator Modules) on Board

- Flexible motherboard design with on board VRM, easy to upgrade with future AMD™ K8 processors.
- 0.800V to 1.55V in 25mV steps.

#### System Memory

- A total of two 184pin DDR SDRAM sockets.
- DIMM sizes from 64 Mbytes to 2Gbyte.
- Supports 266/333/400 DDR SDRAM memory types.

#### System BIOS

- PnP, APM, ATAPI and Windows® 2000/XP.
- Full support of ACPI & DMI.
- Auto detects and supports LBA harddisk with capacities over 160GB.
- Easy to upgrade BIOS by end-user.

#### Plug and Play

- Supports Plug and Play specification 1.1.
- Plug and play for Windows® 2000, as well as Windows® XP.
- Fully steerable PCI interrupts.

#### TV Out (Only for RS482/RS480)

- Integrated TV encoder.
- 10-bit DAC with 4-tap filter.
- PAL/NTSC TV Out with Composite and S-Video outputs (via a header).
- ATI's exclusive "Composite Dot Crawl" freeze option for PAL and NTSC to improve the picture quality.
- TV-Out power management support.

**On-board I/O**

- Two on board PCI fast IDE ports supporting up to 4 ATA, ATA2 , Ultra ATA33/66/100/133 IDE HDDs, CD-ROMs, ZIP drives and LS-120 drives as boot drive.
- One ECP/EPP parallel port.
- One 16550 Compatible UART serial port (via a header).
- One floppy port which supports two FDD of 1.44MB, 2.88MB capacity.
- Eight USB ports (four ports via two headers).
- PS/2 keyboard support.
- PS/2 mouse support.
- One front panel sound connector.
- Infrared (IrDA) support via a header.

**Expanded USB Support**

- Includes 2 OHCI host controllers, increasing the number of external ports to eight.
- Includes 1 EHCI USB2.0 Host Controller that supports all eight ports (Bandwidth is shared between the eight ports).
- This motherboard supports USB 2.0 feature only on Windows® 2000 (with SP4 or above) and Windows® XP (with SP1 or above) operating systems.

**On-board VGA (Only for RS482/RS480)**

- Integrated ATI PCIE X300 graphic core.
- Supports CRT or TV Out display.
- Integrated DAC and CRT controllers.
- Full screen/full speed video playback.
- Up to 2048x1536, non-interlaced screen resolution for CRT.
- Supports on board GDDR memory, and up to 128MB of shared memory (optional).

**On-board Realtek RTL8100C/RTL8110S PCI LAN (optional)**

- Provides 32-bit performance, PCI bus master capability.
- Full compliance with IEEE 802.3u 100 Base-T specifications and IEEE 802.3X Full Duplex Flow Control.
- Supports 10 Mb/s, 100 Mb/s and 1000 Mb/s (only for RTL8110S) operation.
- Supports Wake-On-LAN function and remote wake-up.
- Supports ACPI, PCI Power management and PCI VPD.

**PCI Express Graphics interface**

- One 16-lane (X16 port) PCI Express graphics port, fully compliant with the PCI Express Base Specification revision 1.0a.
  - A base PCI Express frequency of 2.5GB/s only.
  - PCI Express support and Enhanced Addressing Mechanism.
-

**PCI ExpressX1 Port**

- Full PCI Express 1.0a compliant.
- Two virtual channel support for full isochronous data transfers.
- Support for full 2.5GB/s bandwidth in each direction per X1 lane.

**Power Management**

- Supports SMM, APM and ACPI.
- Break switch for instant suspend/resume on system operations.
- Energy star "Green PC" compliant.
- Hardware monitoring circuit provides voltage, fan speed, etc. monitoring (optional).
- External Modem Ring-in Wake-up support.
- Supports suspend-to-RAM (STR) (optional).

**Note: Make sure that the current of your 5VSB power supply is more than 1.5A.**

**Please use a 300 watt power supply or greater.**

**On-board AC97 Sound (optional)**

- Integrated AC97 controller with standard AC97 Codec.
- Direct Sound and Sound Blaster compatible.
- Full-Duplex 16-bit record and play back.
- PnP and APM 1.2 support.
- Windows® 2000/XP ready.
- Line-in, Line-out, Mic-in.
- Supports ALC655 AC97 codes for six sound channel output (optional).

**On-board IEEE1394 (optional)**

- Compliant with 1394 OHCI specifications v1.0 and v1.1.
- Integrated 400Mbit 2 port PHY.

**On board Serial ATA host Controller (optional)**

- Independent DMA operation on four ports.
- Data transfer rates of 150Mb/s.
- RAID feature support .

**Expansion Slots**

- 1 PCI Express X16 slot.
- 1 PCI Express X1 slot.
- 5 PCI slots, - ver. 2.2 compliant.



Static electricity can harm delicate components of the motherboard. To prevent damage caused by static electricity, discharge the static electricity from your body before you touch any of the computers electronic components.

## MOTHERBOARD LAYOUT

The following diagram shows the relative positions of the jumpers, connectors, major components and memory banks on the motherboard.

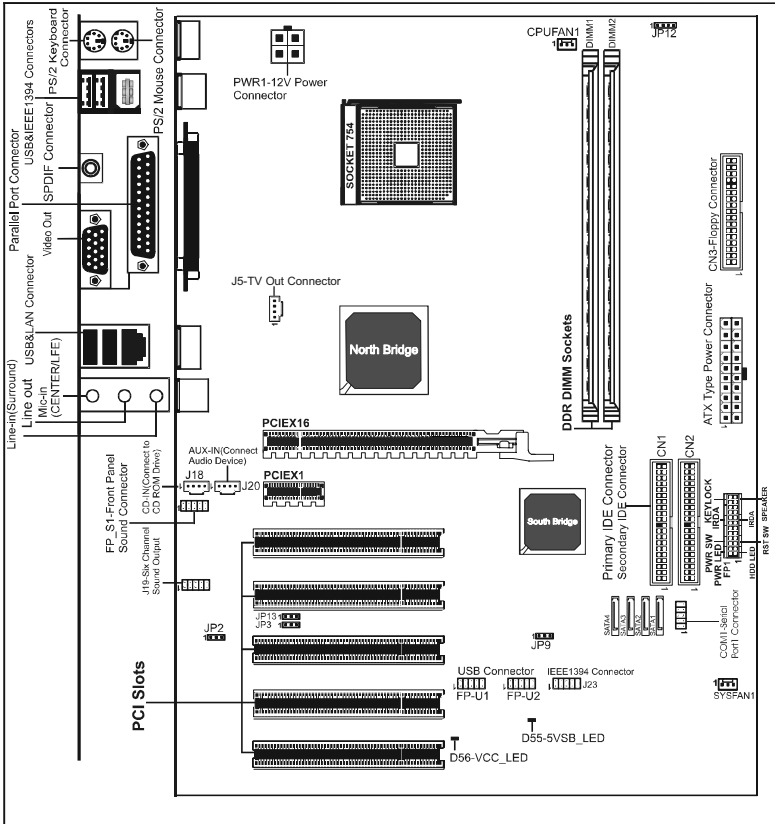

### NOTE

- 1) Be sure to check the cable orientation in order to match the coloured strip to the pin 1 end of the connector.
- 2) When you start up the system, please wait for 5 seconds after you power on AC.
- 3) Adding a metal spaced plate to the back of the Socket 754 is not recommended as this will short motherboard components and damage the system.

## REAR PANEL

The back panel provides the following connectors:

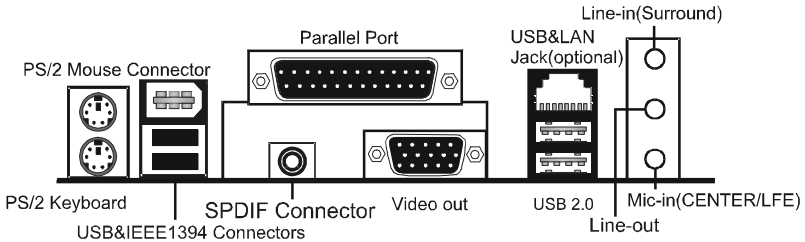

### PS/2 Mouse Connector

The motherboard provides a standard PS/2<sup>®</sup> mouse mini DIN connector for attaching a PS/2<sup>®</sup> mouse. You can plug a PS/2<sup>®</sup> mouse directly into this connector.

### PS/2 Keyboard Connector

The motherboard provides a standard PS/2<sup>®</sup> keyboard mini DIN connector for attaching a PS/2<sup>®</sup> keyboard. You can plug a PS/2<sup>®</sup> keyboard directly into this connector.

### USB 2.0 Connector

The motherboard provides an OHCI (Open Host Controller Interface) Universal Serial Bus root for attaching USB devices such as keyboard, mouse or other USB-compatible devices. You can plug the USB device directly into the connector.

#### USB 2.0 Connector

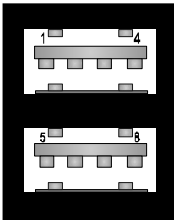

#### USB 2.0 Connector Description

PIN	SIGNAL	DESCRIPTION
1	VCC	+5V/5VSB (optional)
2	-Data 0	Negative Data Channel 0
3	+Data0	Positive Data Channel 0
4	GND	Ground
5	VCC	+5V/5VSB (optional)
6	-Data 1	Negative Data Channel 1
7	+Data 1	Positive Data Channel 1
8	GND	Ground



**VIA VT6307 IEEE 1394 Connector (Optional)**

The mainboard provides an IEEE 1394 Connector and allows you to connect an IEEE 1394 device directly to the connector.

**Video Out Connector (Optional)**

The mainboard provides a Video out port to connect a 15-pin analog video monitor.

**SPDIF Connector (Optional)**

The mainboard provides a S-Bracket (SPDIF) connector that allows you to connect a S-Bracket (coaxial) for a Digital Interface (SPDIF).

**LAN Jack (Optional)**

The mainboard provides one standard RJ-45 jack for connecting to a Local Area Network (LAN). You can connect a network cable to the LAN jack.

**Parallel Port Connector: LPT1**

The mainboard provides a 25-pin female centronic connector. A parallel port is a standard printer port that supports Enhanced Parallel Port (EPP) and Extended Capabilities Parallel Port (ECP) mode.

**Audio Port Connector**

**Line\_Out** is a connector for speakers or headphones. **Line\_In** is used for external CD players, tape players, or other audio devices. **Mic\_In** is the microphone connector.

The ALC655 embeds an internal analog switch (by driver software) to select LINE input or Surround output, and to select MIC input or CENTER/LFE output.

---

## AUDIO CONFIGURATION

After installing the audio driver, you can select 2/4/6 channel surround audio output in the software utility and then connect surround speakers to appropriate audio ports.

There are two ways to obtain 2/4/6 channel surround audio output:

1. 2/4/6 channel audio output on back panel only. All surround speakers connect to this audio connector.
2. Using the S-Bracket (optional cable). You have install the S-Bracket into the computer. Connect two front speakers to back panel's "Line Out" port, and the rest of speakers to S-Bracket. For connection details, please refer to page 15.

## SPEAKER CONFIGURATION

### Method 1: 2/4/6 Channel audio output on back panel only.

After installing the audio drivers, you can attach the speakers for 2-/4-/6- channel audio output. Please connect the speakers to the LINE OUT connectors. Different connector configurations for 2-/4-/6-channel options are listed below:

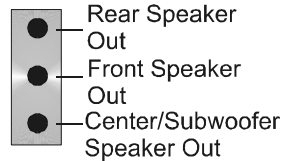
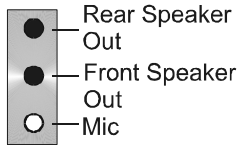
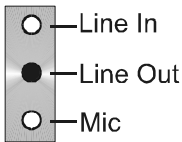

### 2-Channel

In 2-channel configuration, Line Out, Line In and MIC functions all exist.

### 4-Channel

When set to 4-channel configuration, Line In is replaced by Rear Speaker Out. The Line in function does not exist.

### 6-Channel

When set to 6-channel configuration, Line In is replaced by Rear Speaker Out. Mic is replaced by Center/Subwoofer Speaker Out. Line in and Mic functions do not exist.

In the software utility, double click the “AC97 Audio configuration” icon  from the window tray on the right bottom.

The “AC97 Audio Configuration” box will appear. Click on the **Speaker Configuration** tab to select the audio mode.

A. When you choose 4-channel mode for 4 speaker output, the selected item is shown (Figure1).

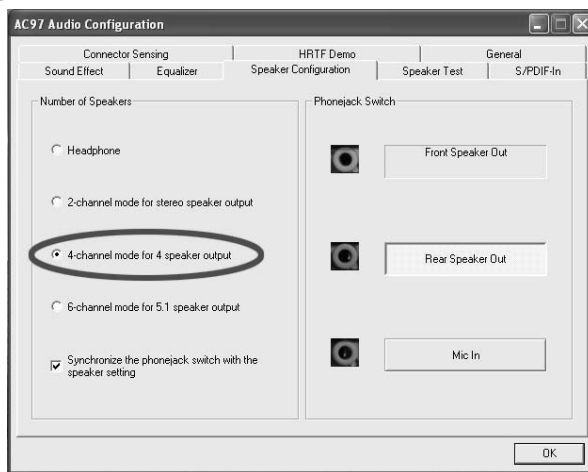

(Figure1)

B. When you choose 6-channel mode for 5.1 speaker output, the selected item is shown (Figure2).

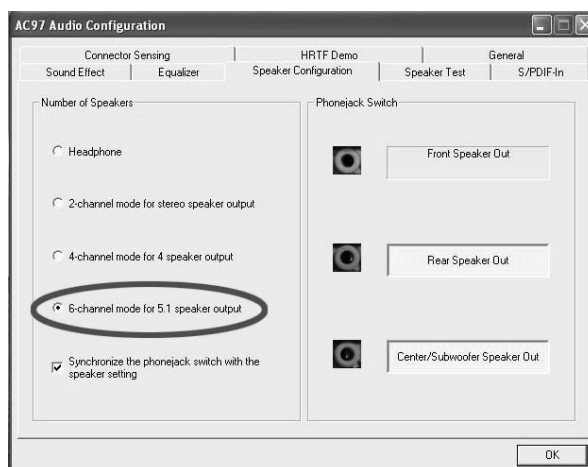

(Figure2)

## Method 2: Using S-Bracket connectors

The S-Bracket (shown on page 15) is an optional accessory. To use the S-Bracket, you should select the correct setting in the software utility. For information about the setting, refer to selecting 4- or 6- Channel Settings later in this section. Connector configurations for 4- and 6- channel using S-Bracket are described below:

### 4-Channel Analog Audio Output

#### Back Panel

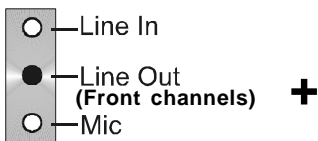

#### S-Bracket

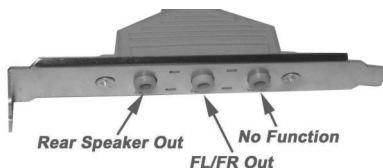

#### Description:

Connect two speakers to the back panel's Line Out connector and two speakers to one Line Out connector on the S-Bracket, or connect all four speakers to one connector on S-Bracket. If you want to use the **Line In** function, please click the **Rear Speaker Out** button (shown below).



## 6-Channel Analog Audio Output

### Back Panel

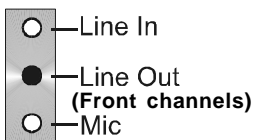

+

### S-Bracket

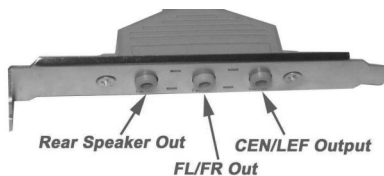

### Description:

Connect two speakers to the back panel's **Line Out** connector and four speakers to the **Line Out** connector of the **S-Bracket**, or attach all six speakers to the connector on the **S-Bracket**. If you want to use the **Line In** and **MIC** functions at the same time, please click the **Rear Speaker Out** and **Center/Subwoofer Speaker Out** buttons (shown below).

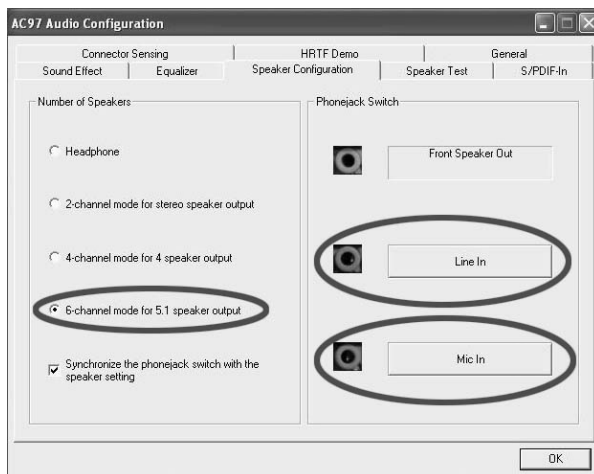

## Connectors

The mainboard provides connectors to connect to the FDD, IDE HDD, USB Ports and to the CPU/System FAN etc.

### Floppy Disk Drive Connector: CN3

The mainboard provides a standard floppy disk drive connector that supports 1.44M, 2.88M floppy disk types.

### Hard Disk Connectors: CN1&CN2

The mainboard has a 32-bit Enhanced PCI IDE and Ultra DMA 33/66/100/133 controller that provides PIO mode 0~4, Bus Master, and Ultra DMA 33/66/100/133 function. You can connect up to four hard disk drives, CD-ROMs, 120MB Floppy (reserved for future BIOS) and other devices.

#### CN1 (Primary IDE Connector)

The first hard drive should always be connected to CN1. CN1 can connect a Master and a Slave drive. You must configure the second hard drive to Slave mode by setting the jumper accordingly.

#### CN2 (Secondary IDE Connector)

CN2 can also connect a Master and a Slave drive.

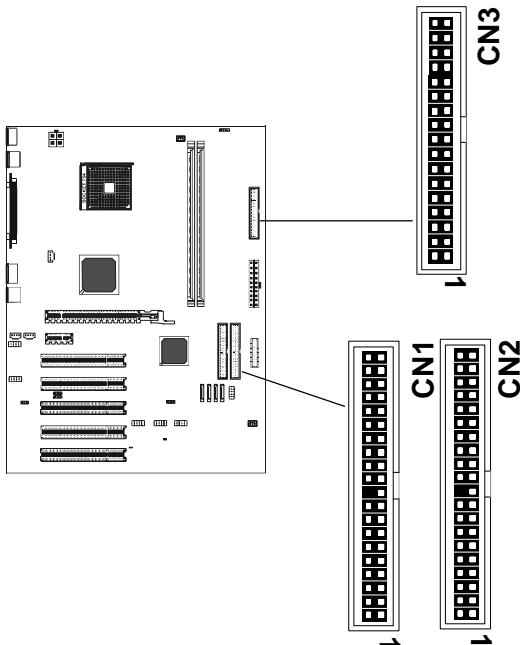

## Back Panel Bracket-Six Channel Audio Output Connector: J19 (Optional)

The motherboard provides a six channel output connector (FL/FR, RL/RR, CEN/LEF) that allows you to use all the 6 channel audio output features at the same time.

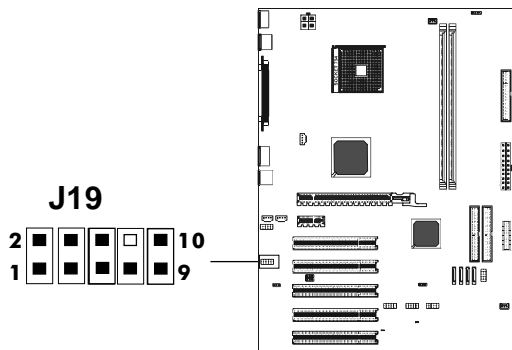

PIN	SIGNAL	DESCRIPTION
1	SOUT-L	Audio left surrounding output
2	SOUT-R	Audio right surrounding output
3	GND	Ground
4	GND	Ground
5	CET-OUT	Audio center output
6	LFE-OUT	Audio bass output
7	GND	Ground
8	NC	Key
9	SPK L	Front left output
10	SPK R	Front right output

### Back Panel Cable (optional)

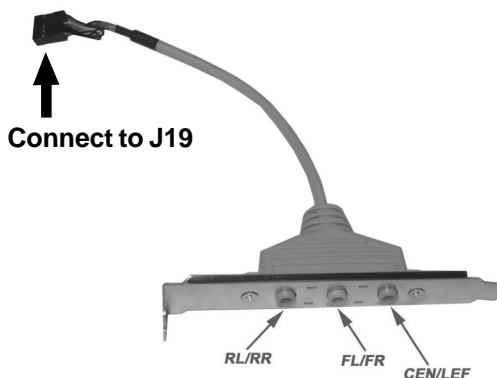

## TV Out Connector

The mainboard provides TV Out connector.

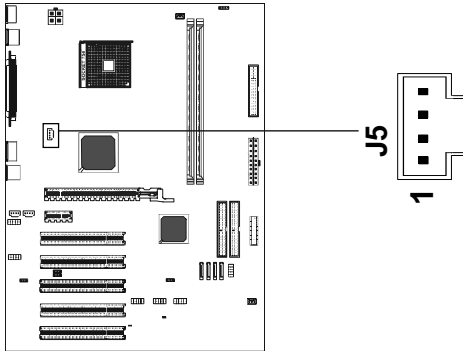

### J5: TV Out

PIN	Assignment
1	C
2	GND
3	COMP/B
4	Y

## TV Out cable





## IEEE 1394 Connectors: J23 (optional)

The mainboard provides two 1394 pin headers that allow you to connect IEEE 1394 ports.

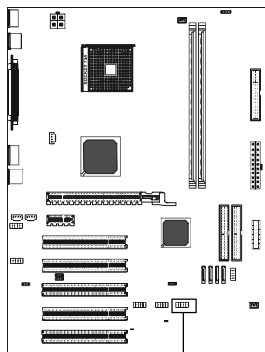

**J23**



PIN	SIGNAL
1	TPA+
2	TPA-
3	Ground
4	Ground
5	TPB+
6	TPB-
7	Cable power
8	Cable power
9	Key (no pin)
10	Ground

## IEEE 1394 Cable (optional)

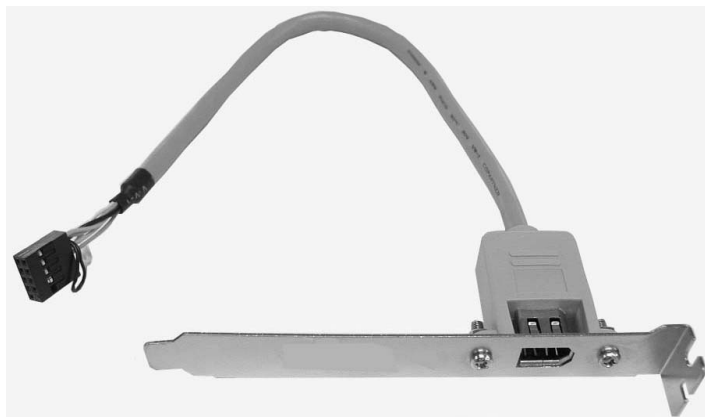

## Chassis Alarm Lead: JP12 (optional)

This lead is for a chassis designed with an intrusion detection feature. This requires an external detection mechanism such as a chassis intrusion sensor or microswitch. When you remove any chassis component, the sensor triggers and sends a high-level signal to this lead to record a chassis intrusion event.

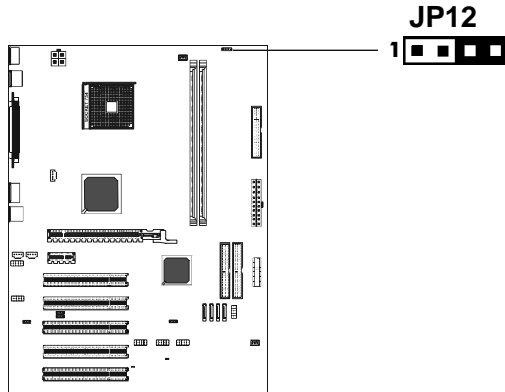

### JP12 Pin Definition

PIN	Assignment
1	+5VSB
2	KEY
3	Chassis Signal
4	GND

**Note:**

If you want to use “Chassis Alarm” Connector, you must remove 3-4 pin jumper.

## Fan Power Connectors: CPUFAN1/SYSFAN1

The CPUFAN1 (processor fan), SYSFAN1 (system fan) supports a system cooling fan using +12V via a three-pin head connector. When connecting the wire to the connectors, always take note that the red wire is the positive and should be connected to the +12V, the black wire is Ground and should be connected to GND. If the mainboard has a System Hardware Monitor chipset on-board, you must use a specially designed fan with speed sensor to take advantage of the CPU fan control.

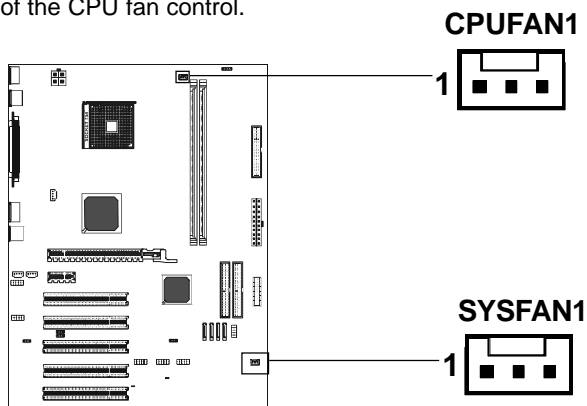

## Power LED: D55/D56 (optional)

The green LED lights when the system is in the power-on state.

The red LED lights whenever AC mains power is attached, irrespective of whether the system is power-on or power-off or standby mode.

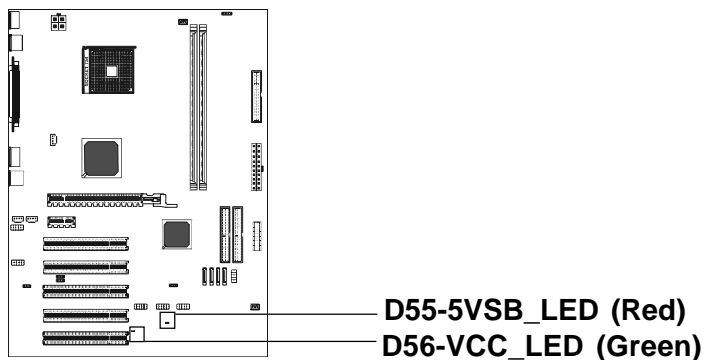

**CD-IN Connector: J18**

The connector is for CD-ROM Drive.

**AUX-IN Connector: J20**

The connector is for Audio Device.

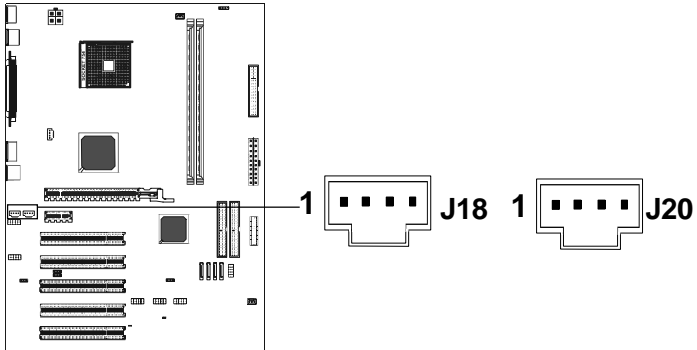
**CDS1: J18**

PIN	Assignment
1	CD-L
2	GND
3	GND
4	CD-R

**AUX1: J20**

PIN	Assignment
1	AUX-L
2	GND
3	GND
4	AUX-R

## Front Panel Audio Header: FP-S1

This mainboard supports front panel microphone and speaker out ports. If your computer case has these ports, connect them to FP-S1.

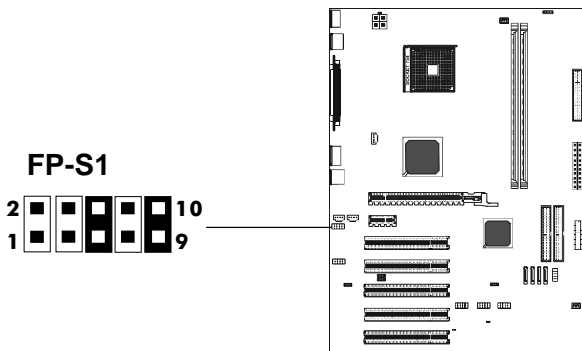

### FP-S1

PIN	Assignment
1	MIC
2	GND
3	REF
4	POWER
5	Front Audio(R)
6	Rear Audio(R)
7	Reserved
8	Key (No pin)
9	Front Audio (L)
10	Rear Audio (L)

#### Note:

*If you want to use the "Front Audio" connector, you must remove the 5-6, 9-10 pin jumpers. In order to utilize the front audio header, your chassis must have front audio connector. Also please make sure the pin assignment on the cable is the same as the pin assignment on the MB header. To find out if the chassis you are buying supports a front audio connector, please contract your dealer.*

## USB Connector: FP-U1/FP-U2

This mainboard has USB ports. Some computer cases have a special module that mounts USB ports at the front of the case. If you have this kind of case, use the auxiliary USB connector FP\_U1/FP\_U2 to connect the front mounted ports to the mainboard.

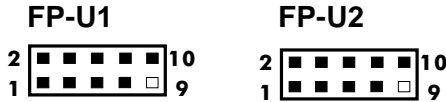
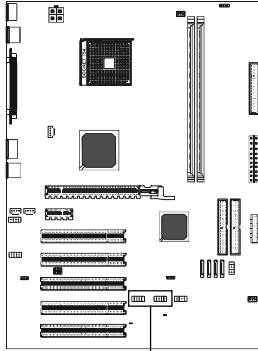

### USB Connector

PIN	Assignment
1	VCC
2	VCC
3	USBP0-
4	USBP1-
5	USBP0+
6	USBP1+
7	GND
8	GND
9	KEY
10	OC#

## Front Panel Header: FP1

The mainboard provides one front panel connector for the front panel switches and LEDs.

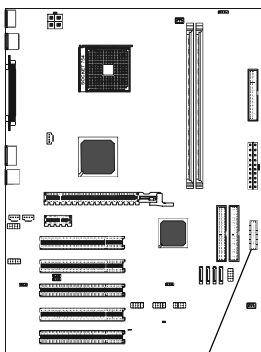

### FP1

24	■ ■	23	VCC
GND	■ ■	21	GND
KEYLOCK	■ ■	19	NC
KEY	□ ■	17	SPEAKER
KEY	□ ■	15	IRTX
IRRX	■ ■	13	VCC
GND	■ ■	11	NC
KEY	□ ■	9	NC
KEY	□ ■	7	RESET
GND	■ ■	5	GND
PWR_SW	■ ■	3	HDD_LED-
PW_LED-	■ ■	1	HDD_LED+
PW_LED+	■ ■		

**Serial ATA Hard Disk Connectors:  
SATA1/SATA2/SATA3/SATA4 (optional)**

The mainboard has four SATA connectors. The mainboard provides optional dual high-speed Serial ATA interface ports, SATA1, 2, 3, 4. Each supports 1<sup>st</sup> generation serial ATA data rates of 150 MB/s. Both connector types are fully compliant with Serial ATA 1.0 specifications. Each Serial ATA connector can connect to 1 hard disk device. Please refer to Serial ATA Raid manual for detail software installation procedure.

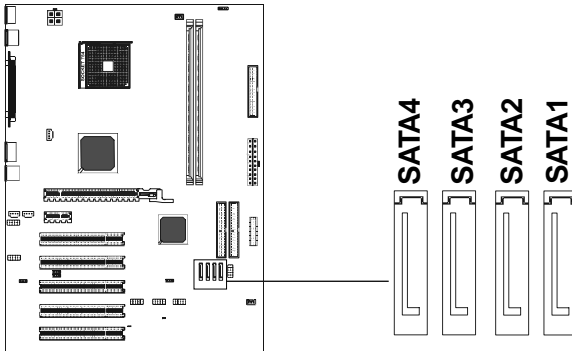

PIN	SIGNAL
1	GND
2	TXP
3	TXN
4	GND
5	RXN
6	RXP
7	GND



---

## Serial ATA Cable



Connect one end of the SATA cable to the mainboard, and connect the other end to the SATA Hard Disk.



Please do not fold the serial ATA cable at a 90 degree angle as this will cause a loss of data during the transmission.

## Serial ATA Hard Disk Devices Power Cable (optional)

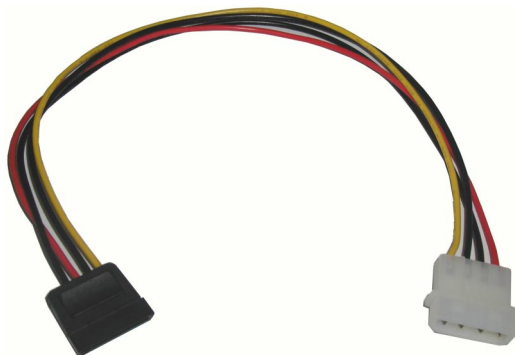

## JUMPER SETTING

This chapter explains how to configure the motherboard's hardware. Before using your computer, make sure all jumpers and DRAM modules are set correctly. Refer to this chapter whenever in doubt.

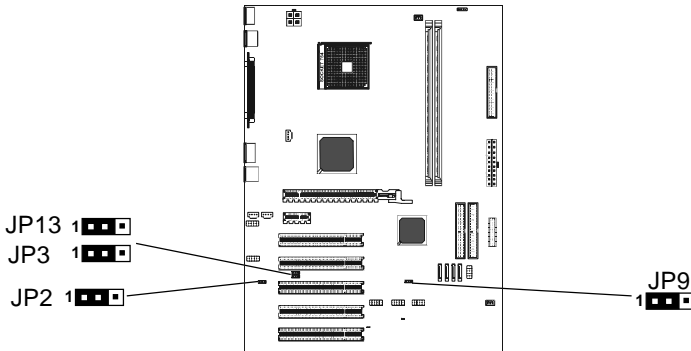

### Clear CMOS Jumper: JP9

If you want to clear the system configuration, use the JP9 (Clear CMOS Jumper) to clear data.

JP9	Selection
1  1-2*	Normal*
1  2-3	CMOS Clear

### JP2-On Board AC97 Sound Select

JP2	Function
1  1-2*	AC97 Sound Enable*
1  2-3	AC97 Sound Disable

### JP13-On Board LAN Select (optional)

JP13	Function
1  1-2*	LAN Enable*
1  2-3	LAN Disable

### JP3-On board IEEE1394 Select (optional)

JP3	Selection
1  1-2*	IEEE1394 Enable*
1  2-3	IEEE1394 Disable



Close



Open

\* = Default setting.

---

## SLOTS

The motherboard provides one PCIe X16 slot, one PCIe X1 slot and five 32-bit PCI slots.

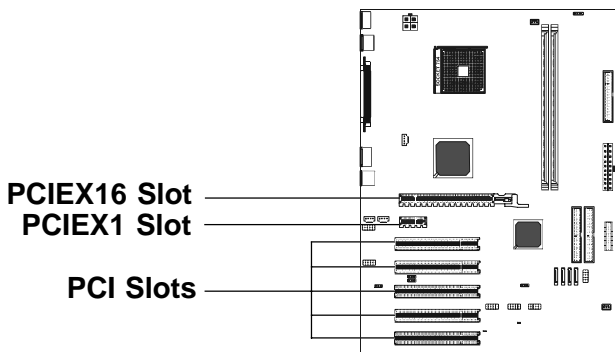

### PCI (Peripheral Component Interconnect) Slots

The PCI slots allow you to insert expansion cards to meet your needs. When adding or removing expansion cards, make sure that you unplug the power supply first. Read the documentation for the expansion card and make any necessary hardware or software settings for the expansion card, such as jumpers, switches or BIOS configuration.

---

## CPU INSTALLATION

Please refer to the steps below to install the CPU.

1. Please turn off the power and unplug the power cord before installing the CPU. Pull the lever up and away from the socket until it is at a 90 degree angle to the mainboard.

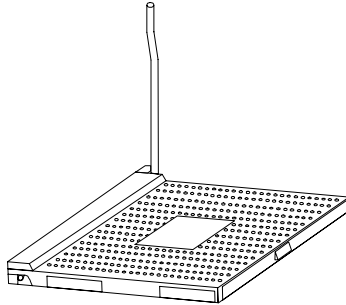

2. Look for the gold arrow on the CPU. The gold arrow should point away from the lever pivot. The CPU can only sit properly in the socket in the correct orientation.

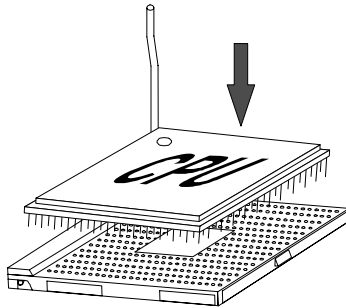

3. If the CPU is correctly seated, the pins should be completely embedded in the socket and can not be seen. (Please note that any deviation from the correct installation procedures may cause permanent damage to your mainboard.)

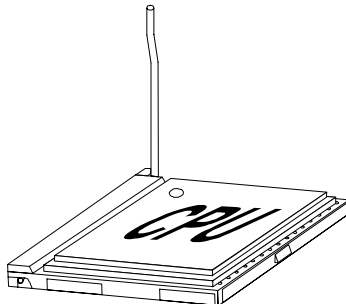

4. Press the CPU down firmly into the socket and close the lever. As the CPU is likely to move while the lever is being closed, always close the lever with your fingers pressing tightly on top of the CPU to make sure the CPU is properly and completely seated in the socket.

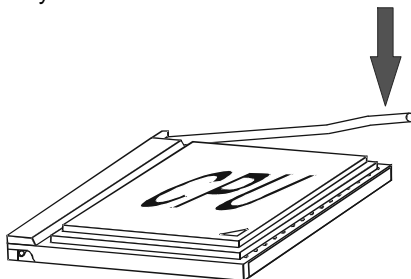

5. When you are installing the CPU, make sure the CPU has a heat sink and a cooling fan attached on the top to prevent overheating. If you do not have the heat sink and cooling fan, contact your dealer to purchase and install them before turning on the computer. Please follow the steps below to install the CPU cooling unit.

Step1. Position the cooling unit onto the motherboard retention mechanism. Hook the clip only end of the cooling unit over the protruding notch on the retention mechanism. On the other side of the cooling unit, press down on the other clip and hook it on to the protruding notch on the retention mechanism.



Step2. Locate the Fixed lever, Safety Hook and the Fixed Bolt. Lift up the fixed lever.



Step3. Fasten down the lever.

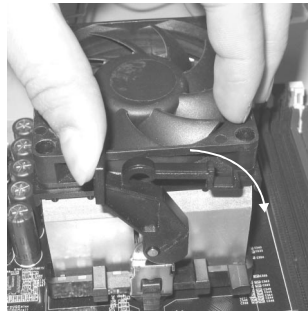

Step4. Make sure the safety hook completely clasps the fixed bolt of the retention mechanism.



---

## Install DDR DIMMs

Please follow the steps below to install the DDR DIMMs.

1. Locate the DDR DIMM sockets.
2. Holding the DDR DIMM by the edges, remove it from its antistatic package.
3. Make sure the clips at either end of the socket are pushed away from the socket.

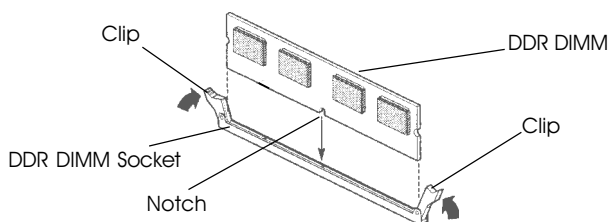

4. Position the DDR DIMM above the socket. Align the notch in the bottom edge of the DDR DIMM with the key in the socket.
5. Insert the bottom edge of the DDR DIMM into the socket.
6. When the DDR DIMM is seated, push down on the top edge of the DDR DIMM until the retaining clips at the ends of the socket snap into place.

**Note: Please turn the system off before installing or removing any device, otherwise system damage can occur.**

---

## BIOS SETUP

### About the Setup Utility

The computer uses the latest Award BIOS with support for Windows Plug and Play. The CMOS chip on the motherboard contains the ROM setup instructions for configuring the motherboard BIOS.

The BIOS (Basic Input and Output System) Setup Utility displays the system's configuration status and provides you with options to set system parameters. The parameters are stored in battery-backed-up CMOS RAM that saves this information when the power is turned off. When the system is turned back on, the system is configured with the values you stored in CMOS.

The BIOS Setup Utility enables you to configure:

- Hard drives, diskette drives and peripherals**
- Video display type and display options**
- Password protection from unauthorized use**
- Power Management features**

The settings made in the Setup Utility affect how the computer performs. Before using the Setup Utility, ensure that you understand the Setup Utility options.

This chapter provides explanations for Setup Utility options.

### The Standard Configuration

A standard configuration has already been set in the Setup Utility. However, we recommend that you read this chapter in case you need to make any changes in the future.

This Setup Utility should be used:

- when changing the system configuration
- when a configuration error is detected and you are prompted to make changes to the Setup Utility
- when trying to resolve IRQ conflicts
- when making changes to the Power Management configuration
- when changing the password or making other changes to the Security Setup

### Entering the Setup Utility

When you power on the system, BIOS enters the Power-On Self Test (POST) routines. POST is a series of built-in diagnostics performed by the BIOS. After the POST routines are completed, the following message appears:



## Main Menu

Once you enter the Award BIOS CMOS Setup Utility, the Main Menu will appear on the screen. The Main Menu allows you to select from various setup functions and two exit choices. Use the arrow keys to select among the items and press <Enter> to accept and enter the sub-menu.

### Phoenix - Award WorkstationBIOS CMOS Setup Utility

<ul style="list-style-type: none"> <li>▶ <b>Standard CMOS Features</b></li> <li>▶ Advanced BIOS Features</li> <li>▶ Advanced Chipset Features</li> <li>▶ Integrated Peripherals</li> <li>▶ Power Management Setup</li> <li>▶ PnP/PCI Configurations</li> <li>▶ PC Health Status</li> </ul>	<ul style="list-style-type: none"> <li>Load Fail-Safe Defaults</li> <li>Load Optimized Defaults</li> <li>Set Supervisor Password</li> <li>Set User Password</li> <li>Save &amp; Exit Setup</li> <li>Exit Without Saving</li> </ul>
Esc : Quit	↑↓→← : Select Item
F10 : Save & Exit Setup	
Time, Date, Hard Disk Type ... ..	

**(Note : The sample BIOS Setup Menu included here only shows a typical case, and may not be exactly the same as the one on your unit.)**

Note that a brief description of each highlighted item will appear at the bottom of the screen.

**Standard CMOS Features** This setup page includes all the items of Award™ special standard features.

**Advanced BIOS Features** This setup page includes all the items of Award™ special enhanced features.

**Advanced Chipset Features** This setup page includes all the items of chipset special

**Integrated Peripherals** This section page includes all the items of IDE hard drive and Programmed Input / Output features.

**Power Management Setup** This entry only appears if your system supports Power Management "Green PC" standards.

**PNP/PCI Configurations** This entry appears if your system supports PNP/PCI.

**PC Health Status** Display CPU and Case Fan Speed etc.

**Load Fail-Safe Defaults** The BIOS defaults that have been set by the manufacturer and represent. Settings which provide the minimum requirements for your system to operate.

**Load Optimized Defaults** These chipset defaults are settings which provide for maximum system performance. While Award has designed the custom BIOS to maximize performance, the manufacturer has the right to change these defaults to meet their needs.

**Set Supervisor/ User Password** Changes, sets, or disables password. It allows you to limit access to the system and the Setup Program.

**Save & Exit Setup** Saves value changes to CMOS and exits setup.

**Exit Without Saving** Abandons all CMOS value changes and exits setup.

**Standard CMOS Features**

The items in Standard CMOS Setup Menu are divided into 10 categories. Each category includes one or more setup items. Use the arrow keys to highlight the item and then use the <PgUp> or <PgDn> key to select the desired value in each item.

Phoenix - Award Workstation BIOS CMOS Setup Utility  
Standard CMOS Features

Date (mm :d d :yy)	Sat. Jan 01 2005	Item Help
Time (h h :mm:ss)	11 : 1 : 35	
▶ IDE Primary Master	[Press Enter 4303 MB]	Menu Level ▶
▶ IDE Primary Slave	[None]	Change the day, month, year and century
▶ IDE Secondary Master	[None]	
▶ IDE Secondary Slave	[None]	
Drive A	[1.44M, 3.5 in.]	
Drive B	[None]	
Video	[EGA/VGA]	
Halt on	[All, but keyboard]	
Base Memory	640K	
Extended Memory	30720K	
Total Memory	31744K	

↑↓→← Move Enter: Select +/-/PU/PD : Value F10 : Save ESC : Exit F1 :General Help  
F5 : Previous Values F6 : Fail-Safe Defaults F7 : Optimized Defaults

**(Note : The sample BIOS Setup Menu included here only shows a typical case, and may not be exactly the same as the one on your unit.)**

---

<b>Date</b>	The date format is <day-of-the-week>. <month> <day> <year>.
<b>Time</b>	The time format is <hour> <Minute> <second> displayed in 24-hour military-time clock. For example, 1 p. m. is displayed as 13:00:00.
<b>Primary Master/Primary Slave/Secondary Master/Secondary</b>	These categories identify the types of the two channels that have been installed in the computer. If the controller of the HDD interface is SCSI, the selection shall be "None".
<b>Drive A Type / Drive B Type</b>	This category identifies the drive types which have been installed in the computer.
<b>Video</b>	The default setting is EGA/VGA.
<b>Halt on</b>	You can select which type of error will cause the system to halt.

### **Advanced BIOS Features**

This section allows you to configure your system for basic operation. You have the opportunity to select the system's default speed, boot up sequence, keyboard operation, shadowing and security.

### **Advanced Chipset Features**

The Chipset Features Setup option is used to change the values of the chipset registers. These registers control most of the system options in the computer.

This section allows you to configure the system based on the specific features of the installed chipset. This chipset manages bus speeds and access to system memory resources, such as DRAM and the external cache. It must be stated that these items should not be altered. The default settings have been chosen because they provide the best operating conditions for your system.

### **Integrated Peripherals**

The Integrated Peripherals Setup allows the user to configure the onboard IDE controller, floppy disk controller, the printer port and the serial ports.

### **Power Management Setup**

The Power Management Setup Menu allows you to configure your system to save the most energy while operating in a manner consistent with your own style of computer use.

### **PNP/PCI Configurations**

This section describes how to configure the PCI bus system. This section covers some very technical items and it is recommended that only experienced users should make any changes to the default settings.

### **PC Health Status**

The PC Health Status displays CPU and Case Fan Speed.

---

### Set Supervisor/User Password

When this function is selected, the following message appears at the center of the screen to assist you in creating a password.

#### ENTER PASSWORD

Type the password, up to eight characters, and press <Enter>. The password typed now will clear any previously entered password from CMOS memory. You will be asked to confirm the password. Type the password again and press <Enter>. You may also press <Esc> to abort the selection. To disable password, just press <Enter> when you are prompted to enter password. A message will confirm the password being disabled. Once the password is disabled, the system will boot and you can enter BIOS Setup freely.

#### PASSWORD DISABLED

If you have selected "**System**" in "Security Option" of "BIOS Features Setup" menu, you will be prompted for the password every time the system reboots or any time you try to enter BIOS Setup. If you have selected "**Setup**" at "Security Option" from "BIOS Features Setup" menu, you will be prompted for the password only when you enter BIOS Setup.

Supervisor Password has higher priority than User Password. You can use Supervisor Password when booting the system or entering BIOS Setup to modify all settings. Also you can use User Password when booting the system or entering BIOS Setup but can not modify any setting if Supervisor Password is enabled.

### Save & Exit Setup

Navigate to this option and press <Enter> to save the changes that you have made in the Setup Utility and exit the Setup Utility. When the Save and Exit dialog box appears, press <Y> to save and exit, or press <N> to return to the main menu.

### Exit Without Saving

Navigate to this option and press <Enter> to discard any changes that you have made in the Setup Utility and exit the Setup Utility. When the Exit Without Saving dialog box appears, press <Y> to discard changes and exit, or press <N> to return to the main menu.

**Note:** If you have made settings that you do not want to save, use the "Exit Without Saving" item and press <Y> to discard any changes you have

---

## FLASH Update Procedure

The program AWDFLASH.EXE is included on the driver CD (D:\Utility\AWDFLASH.EXE). Please follow the recommended procedure to update the flash BIOS, as listed below.

1. Create a DOS-bootable floppy diskette. Copy the new BIOS file (just obtained or downloaded) and the utility program AWDFLASH.EXE to the diskette.
2. Allow the PC system to boot from the DOS diskette.
3. At the DOS prompt, type

**AWDFLASH<ENTER>**

4. Enter the file name of the new BIOS.
5. The question: "Do you want to save BIOS (Y/N)?" is displayed.

***Press "N" if there is no need to save the existing BIOS.  
Press "Y" if a backup copy of the existing BIOS is needed.  
(A file name has to be assigned to the existing BIOS binary file.)***

6. The message : "Press "Y" to program or "N" to exit" is displayed. Type

**"Y"<ENTER>**

7. Wait until the flash-update is completed.
8. Restart the PC.

<p><b>Warning :</b> - Do not turn off or RESET the computer during the flash process. - If you are not sure how to upgrade the BIOS, please take your computer to an Authorized Service Center and have a trained technician do the work for you.</p>
---

## SATA RAID User Manual

Creating and deleting RAID sets is a function found in the BIOS. During boot up, the following message will appear, pausing for a few moments to allow the user to choose what to do:

Press Ctrl+S or F4 to enter RAID utility

An easy-to-use screen will appear with the following choices:

Create RAID Set   Delete RAID Set   Rebuild RAID Set   Resolve Conflicts

Below this will be listed the drives currently installed on the system.

The top right half of the screen displays directions and comments for the user. The bottom right half lists the command keys:

Arrows up and down are Select Keys

ESC takes the user to the previous menu

Enter selects the user's choice

Ctrl-E exits the utility

### Creating RAID Sets

Because SATA Raid supports two drives, creating RAID Sets is a simple procedure.

1. Select "Create RAID Set".
2. Choose either a "Striped" or "Mirrored" RAID Set.
3. Select if you want the utility to Auto Configure the RAID Set or if you want to manually configure the RAID Set. For Striped Sets, you can change the chunk size. For Mirrored Sets, you assign which is the Source and Target drives, as well as if you want Disk Copy.

**What is Disk Copy?** If the disk assigned as the source disk has already been partitioned and has data stored on it, and then a second disk is added for redundancy, the data on the source drive can be copied to the destination drive, so that the disks are identical, and all subsequent data will be written to both drives as a Mirrored set. If, however, the source disk does not have data already stored on it, there is no need for Disk Copy.

4. The utility will ask "Are You Sure?" Before completing the configuration.

### Deleting RAID Sets

1. To remove one or more RAID sets, select "Delete RAID Set."
2. Select desired set and press Y when asked "Are You Sure?"

### Resolving Conflict

When a RAID set is created, the metadata written to the disk includes drive connection information (Primary Channel, Secondary Channel). If, after a disk failure, the replacement disk was previously part of a RAID set (or used in another system), it may have conflicting metadata, specifically in reference to the drive connection information. If so, this will prohibit the RAID set from being either created or rebuilt. In order for the RAID set to function properly, this old metadata must be first overwritten with the new metadata.

To resolve this, select "Resolve Conflict" and the correct metadata, including the correct drive connection information, will be written to the replacement disk.

---

## DRIVER AND RAID SOFTWARE INSTALLATION

### Microsoft Windows Driver Installation

1. After Windows has finished booting up, the system will automatically find the newly installed adapter and prompt the **Found New Hardware Wizard** window. Click **Cancel** to skip it.



2. Insert the bundled driver CD into your CD-ROM drive and select “**ATI Chipset\ATI\_Raid Driver**” installation bar on the dialogue window to begin the driver and software installation. (Please follow the instructions to finish the installation.)

### Install Windows 2000/XP

- a. Insert the bundled driver CD DISC into CD-ROM (G:). Copy all files from the directory ( G:\**ATI chipset\ATI\_Raid** ) to a floppy disk.
  - b. Install the OS from CD-ROM.
  - c. Press “**F6**” at the prompt “Press **F6** if you need to install a third party SCSI or RAID driver...”.
  - d. Insert the floppy disk.
  - e. Choose the OS device driver to be loaded.
  - f. Install the OS.
  - g. Install the driver after OS is installed.
-

## **APPENDIX**

### **Note to User:**

The bundled driver CD contains all the drivers that the motherboard needs. Each driver will install automatically once it is selected. Please select the drivers that you want to install by clicking on the driver's button.