

# PA-2006



## MAINBOARD MANUAL

DOC No. : 15579

Rev. : A2

Date : 4, 1997

Part No. : 25-10580-05

## Table of Contents

### Chapter 1 Overview

|  |   |
|--|---|
| Main Features .....                              | 2 |
| This User Manual .....                           | 4 |
| Something Interesting.....                       | 5 |
| The BIOS Setup Utility .....                     | 5 |
| IRQ Functionality.....                           | 6 |
| DMA Channels of ISA Cards .....                  | 7 |
| Enhanced IDE.....                                | 7 |
| Serial Infrared (SIR) Connections.....           | 8 |
| Highly Convenient Integrated I/O Connectors..... | 9 |

### Chapter 2 Installation Procedures

|   |    |
|---|----|
| Mainboard Layout.....   | 12 |
| 1). Set System Jumpers .....                                    | 13 |
| Jumpers .....   | 13 |
| Clear Password: CPW.....  | 14 |
| Flash EPROM Type Selection: EP1, EP2.....                       | 14 |
| CPU to SRAM Data Transacting Mode Selection: SRAM3 ...          | 15 |
| 2). Install DRAM Modules.....                                   | 16 |
| DRAM and SDRAM.....   | 16 |
| RAM Module Configuration.....                                   | 17 |
| Install SIMMs.....  | 20 |
| Remove SIMMs .....  | 20 |
| Install DIMMs .....   | 21 |
| Remove DIMMs.....   | 21 |
| Cache Memory.....   | 22 |
| Install Cache SRAM Module.....                                  | 22 |
| Onboard Cache SRAM (256KB/512KB) .....                          | 23 |
| Onboard Cache SRAM and SDRAM Module Mixture<br>(512KB/1MB)..... | 24 |
| SRAM Module (256KB/512KB) .....                                 | 25 |
| 3). Install the CPUs.....                                       | 26 |
| System Clock Selection:<br>CLK1, CLK2, CLK3.....                | 27 |

|   |    |
|---|----|
| CPU to Bus Frequency Ratio Selection:   |    |
| FREQ1, FREQ2.....   | 27 |
| Intel Pentium CPUs .....  | 28 |
| Frequency.....  | 28 |
| Voltage.....  | 29 |
| AMD-K5/K6 CPUs.....   | 30 |
| Frequency.....  | 30 |
| Voltage.....  | 31 |
| Cyrix 6x86 CPUs.....  | 32 |
| Frequency.....  | 32 |
| Voltage.....  | 33 |
| IBM 6x86 CPUs .....   | 34 |
| Frequency.....  | 34 |
| Voltage.....  | 35 |
| Installation of Cyrix (or IBM) 6x86 CPU Fan.....                                    | 36 |
| 4). Install Expansion Cards .....   | 37 |
| 5). Connect Cables and Power Supply .....   | 39 |
| Keyboard Connector: AT_KB .....   | 39 |
| Serial Port Connectors: COM1 and COM2.....  | 39 |
| CPU Fan Connectors: FAN .....   | 40 |
| Floppy Diskette Drive Connector: FLOPPY .....                                       | 40 |
| Front Panel Block Connector: F_PNL .....  | 41 |
| Infrared Connector: IR .....  | 42 |
| Outlet Connector: OUTLET .....  | 42 |
| Power Connector: POWER .....  | 43 |
| IDE HDD Device Connectors:  |    |
| PRIMARY and SECONDARY .....   | 44 |
| Printer Block Connector: PRINTER.....   | 44 |
| Remote Power Connector: RPW_CON.....  | 45 |
| Universal Serial Bus Connector: USB1 and USB2<br>(Reserved For Future Upgrade)..... | 45 |

### **Chapter 3 Award BIOS Setup**

|                           |    |
|---------------------------|----|
| CMOS Setup Utility.....   | 47 |
| Standard CMOS Setup ..... | 48 |
| BIOS Features Setup.....  | 50 |

---

|                               |    |
|-------------------------------|----|
| Chipset Features Setup.....   | 53 |
| Power Management Setup.....   | 58 |
| PCI Configuration Setup.....  | 61 |
| PnP Configuration Setup.....  | 63 |
| Load BIOS Defaults.....       | 64 |
| Load Setup Defaults.....      | 64 |
| Supervisor/User Password..... | 64 |
| IDE HDD Auto Detection.....   | 65 |
| Save and Exit Setup.....      | 66 |
| Exit without Saving.....      | 66 |

**Appendix A Applicatin Note**

---

**This Page Intentionally Left Blank**

## Overview

The PA-2006 mainboard combines the advanced capabilities of the VIA 580VP chipset with a high-performance concurrent PCI local bus architecture to provide the ideal platform for unleashing the unsurpassed speed and power of the Intel Pentium processor.

This highly-flexible mainboard is designed to run a full range of Intel Pentium, Cyrix 6x86 (M1/M2), IBM 6x86 (M1/ M2), and AMD-K5/K6 processors, and can be easily upgraded using its 321-pin ZIF socket. The processor's advanced performance is complemented by a second level write back Pipeline Burst SRAM cache of up to 1MB (by one cache RAM module slot for 1MB PBSRAM cache module) and main memory of up to 384MB DRAM. The main memory is installed using the board's two 72-pin SIMM sockets and two 168-pin DIMM sockets that accept a choice of lightning-fast synchronous DRAM (SDRAM) and high-speed EDO DRAM.

The PA-2006 integrates a full set of I/O features onboard, including two 16550A UART compatible serial ports, one EPP/ECP capable parallel port, and one Floppy Disk Drive controller. It also comes with a built in Enhanced IDE controller that provides convenient, high-speed PCI Bus Master connections with up to four IDE devices, including Hard Disk and CD-ROM drives. Four 16-bit ISA slots and four 32-bit PCI slots provide ample room for further expansion. The mainboard also features support for the state-of-the-art Universal Serial Bus (USB) that provides ease-of-use and high-speed Plug & Play connections to future USB compliant peripheral devices. The IrDA compliant serial port and onboard SIR support further enhance system I/O connectivity.

This chapter gives you a brief overview of the PA-2006 mainboard. In addition to basic information on the board's main components and features, it also provides advice on how to upgrade and expand it. For updated BIOS, drivers, or product release information, please visit FIC's home page at: <http://www.fic.com.tw>.

## Main Features

The PA-2006 mainboard comes with the following high-performance features:

- **Easy Installation**  
Award BIOS with support for Plug and Play, auto detection of Hard Drive and IDE features, MS Windows 95, and Windows NT compatible.
- **Flexible Processor Support**  
Onboard 321-pin ZIF socket and switching voltage regulator support complete range of leading-edge processors:  
Intel Pentium® 75MHz – 200MHz (P55C with MMX™ technology; P54C/P54CS)  
AMD-K6™-PR166 – PR233  
AMD-K5™-PR75 – PR166  
Cyrix M2 Series processors  
Cyrix 6x86™-PR120+ – PR200+\*  
IBM M2 Series processors  
IBM 6x86™-PR120+ – PR200+\*0.

**NOTE** : \* Support for Cyrix 6x86-PR200+ and IBM 6x86-PR200+ is optional.

- **Leading Edge Chipset**  
VIA 580VP chipset, including a CPU interface controller, advanced cache controller, integrated DRAM controller, synchronous ISA bus controller, PCI local bus interface, integrated power management unit.
- **Ultra-fast Level II Cache**  
Supports onboard 256KB/512KB synchronous PBSRAM cache memory and one cache module slot for 1MB PBSRAM cache module.
- **Versatile Main Memory Support**  
Accepts up to 256MB RAM in one bank using 72-pin SIMMs of 4, 8, 16, 32, 64, 128MB or up to 128MB RAM in two banks using two 168-pin DIMMs of 8, 16, 32, 64MB with support for SDRAM and EDO memory.
- **ISA & PCI Expansion Slots**  
Four 16-bit ISA and four 32-bit PCI expansion slots provide all the room you need to install a full range of add-on cards.

- **USB Support**  
Onboard support for two Universal Serial Bus connectors via a plug-in connector.
  
- **Enhanced PCI Bus Master IDE Controller**  
Integrated Enhanced PCI local bus IDE controller with two connectors supports up to four IDE devices such as Hard Disk, CD-ROM or Tape Backup drives via two channels for high speed data throughput. This controller supports PIO Modes 3 and 4, and DMA Mode 2 for optimized system performance.
  
- **Super Multi I/O**  
Integrated Winbond 83877F chipset features two 16550A UART compatible serial ports, one EPP/ECP capable parallel port, one IR port, and one Floppy Disk Drive connector.



## This User Manual

This manual is designed to guide you and facilitate your use of the PA-2006 mainboard. It contains a description of the design and features of the mainboard, and also includes useful information for changing the configuration of the board and the system it is installed in. The manual is divided into three chapters:

- **Chapter 1 - Overview**  
gives an overview of the mainboard and describes its major components and features.
- **Chapter 2 - Installation Procedures**  
gives instructions on how to set up the mainboard, including jumper settings and CPU installation guides.
- **Chapter 3 - Award BIOS Setup**  
briefly explains the mainboard's BIOS system setup in general and tells you how to run it and change the system configuration settings.

|   |
|---|
| <p><b>NOTE :</b> The material in this manual is for information only and is subject to change without notice. We reserve the right to make changes in the product design without reservation and without notification to its users. We shall not be liable for technical or editorial omissions made herein; nor for incidental or consequential damages resulting from the furnishing, performance, or use of this material.</p> |
|---|

## Something Interesting

This section provides useful information that you will need to know should you decide to modify or upgrade the configuration of the mainboard and the system it is installed in. If you do not have the confidence to upgrade the mainboard yourself, we advise that you consult a qualified service technician for assistance.

## The BIOS Setup Utility

The BIOS (Basic Input Output System) is the basic firmware that instructs the computer how to operate. For the BIOS to work properly, there must be a record of the computer's hardware and configuration settings for it to refer to. This record is created using the Setup Utility, a program that is stored permanently in the BIOS ROM chip on the mainboard.

The system configuration record created by the Setup Utility is also stored on the mainboard, but not permanently. This section of the memory it is stored in is the NVRAM.

When you buy your computer, the system configuration record will already be set and may in some cases differ from the basic defaults. The first time you use your computer or when you need to re-configure your system, you should run the Setup Utility and write down the settings.

## IRQ Functionality

As you read through this manual, you will see the term IRQ on a number of occasions. It is important for you to know what this term means, particularly if you intend to upgrade your system.

IRQ stands for Interrupt Request, the process in which an input or output device tells the processor to temporarily interrupt its current task and immediately process something from the source of the interrupt. When it has completed this, the processor returns to the task it was already processing. Devices that need an IRQ line to operate sometimes need to have exclusive use of that line.

A large number of add-on cards, such as sound cards and LAN cards, require the use of an IRQ line to function. Some of IRQs may already be in use by components in the system such as the keyboard and mouse. Add-on cards that need to use an IRQ draw from the unused group of IRQs. When installing a card that uses an IRQ, it will have a default IRQ setting which you might have to change if that IRQ is already in use and cannot be shared.

Both ISA and PCI add-on cards may need to use IRQs. System IRQs are available to add-on cards installed on the ISA bus first; the remaining ones can be used by cards installed on the PCI bus. There are two categories of ISA add-on cards: so-called Legacy ISA cards, which need to be configured manually and then installed in any available ISA slot; and Plug and Play (PnP) ISA cards, which are configured automatically by the system. As a result, when you install Legacy ISA cards, you have to carefully configure the system to ensure that the installed cards do not conflict with each other by having the same IRQ. With PnP cards, on the other hand, IRQs are assigned automatically from the ones available in the system. In the case of PCI add-on cards, the BIOS automatically assigns an IRQ card to the PCI slot the card is installed in.

## **DMA Channels of ISA Cards**

Some Legacy and PnP ISA add-on cards may also need to use a Direct Memory Access (DMA) channel. DMA assignments for this mainboard are handled in the same way as the IRQ assignment process outlined above. For more information, please refer to Chapter 3 of this manual.

## **Enhanced IDE**

This mainboard features an integrated Enhanced IDE controller that provides convenient, high-speed connections with up to four IDE devices, such as Hard Disk, CD-ROM and Tape Backup Drives. Enhanced IDE is an upgrade of the original IDE specification and provides increased capabilities and performance in a number of areas, including support for Hard Disk Drives of over 1.2GB and faster data transfer rates utilizing the PIO Mode 4 timing scheme.

With the integrated IDE controller you can connect up to four IDE peripheral devices to your system. All devices are categorized in the same way that IDE Hard Disks were configured in the past, with one device set as the Master device and the other as the Slave device. We recommend that Hard Disk Drives use the Primary IDE connector and that CD-ROM drives utilize the Secondary IDE connector for improved system performance.

## Serial Infrared (SIR) Connections

This mainboard features support for highly-sophisticated SIR technology, which allows bi-directional and cordless data transactions with other IrDA compliant computers and peripheral devices using infrared as a medium. This transmission is carried out in either Full Duplex Mode or Half Duplex Mode. The former allows simultaneous data transmission and reception, while the latter disables the reception when transmission occurs.

The I/O chipset on this mainboard features a SIR interface that is fully compliant with the IrDA standard. An IrDA device can be installed via a 9-pin D-SUB connector in the rear panel of the computer which is linked by a cable to the onboard IrDA pinhead, as shown in the illustration below.

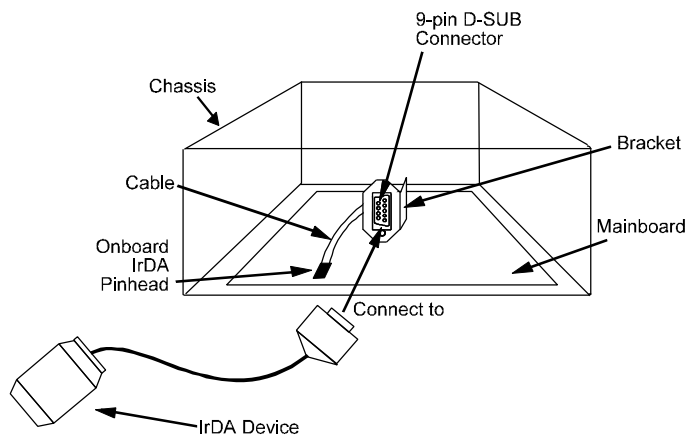

The serial port COM2 on this mainboard is designed to be a SIR compliant port. If you wish to install the SIR connection feature, you need to adjust the BIOS option for high-speed performance.

## Highly Convenient Integrated I/O Connectors

This mainboard features has an integrated rear I/O panel that incorporates a full set of I/O ports to allow simple and convenient connections to a complete selection of external peripheral devices.

In addition to two 16550A UART compatible serial ports and one EPP/ECP capable parallel port, the panel features two USB connectors that provide high speed connection to the next generation of USB devices. PS/2 keyboard and PS/2 mouse connectors provide additional I/O connectivity.

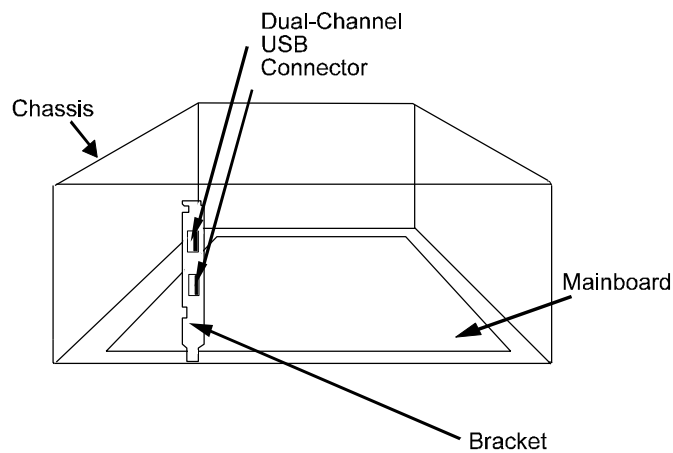

**NOTE :** USB Feature is reserved for future upgrade.

**This Page Intentionally Left Blank**

## Installation Procedures

The PA-2006 has several user-adjustable jumpers on the board that allow you to configure your system to suit your requirements. This chapter contains information on the various jumper settings on your mainboard.

To set up your computer, you should follow these installation steps:

- n Step 1 -  
Set system jumpers
- n Step 2 -  
Install RAM modules
- n Step 3 -  
Install the CPU
- n Step 4 -  
Install expansion cards
- n Step 5 -  
Connect cables and power supply
- n Step 6 -  
Set up BIOS feature (Please read Chapter Three.)



## Mainboard Layout

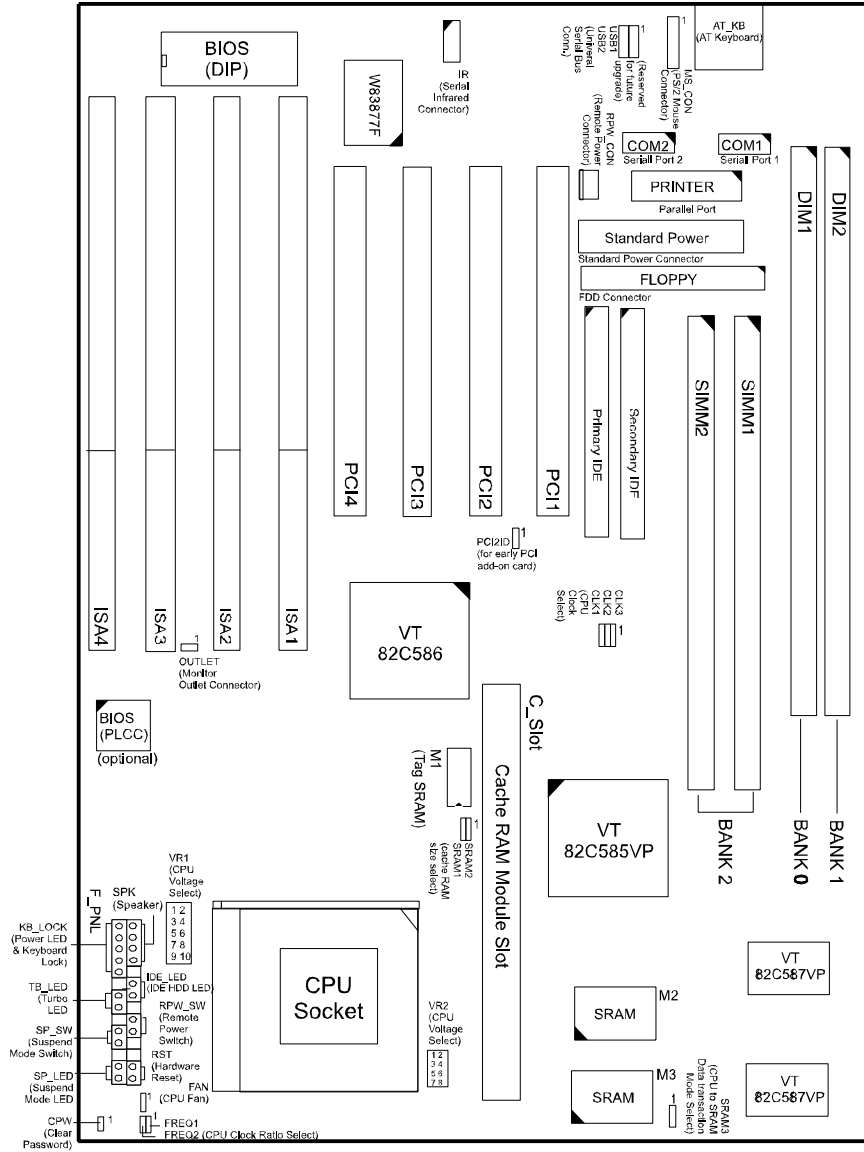

## 1). Set System Jumpers

### *Jumpers*

Jumpers are used to select the operation modes for your system. Some jumpers on the board have three metal pins with each pin representing a different function. To set a jumper, a black cap containing metal contacts is placed over the jumper pin/s according to the required configuration. A jumper is said to be shorted when the black cap has been placed on one or two of its pins. The types of jumpers used in this manual are shown below:

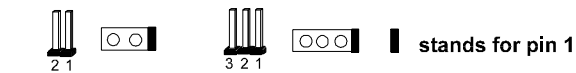
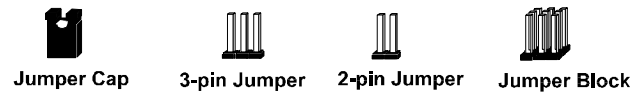

Jumpers are shown as above



Jumper cap is shown as above



Jumpers in a Block

**NOTE :** Users are not encouraged to change the jumper settings not listed in this manual. Changing the jumper settings improperly may adversely affect system performance.

***Clear Password: CPW***

This jumper allows you to set the password configuration to Enabled or Disabled. You may need to enable this jumper if you forget your password.

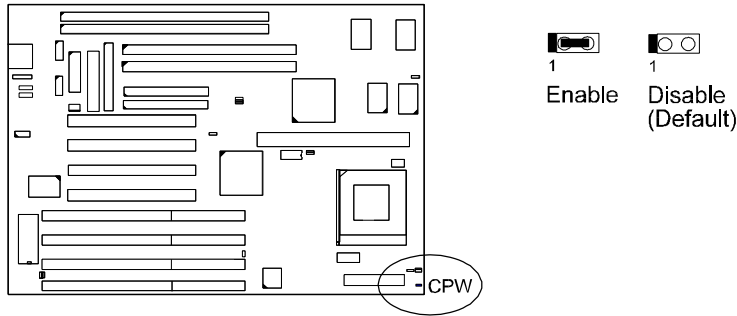

***PCI2 ID: PCI2ID***

This setting is provided to allow you to install more than one PCI add-on card released before the launch of the PCI Encoding Standard in 1993.

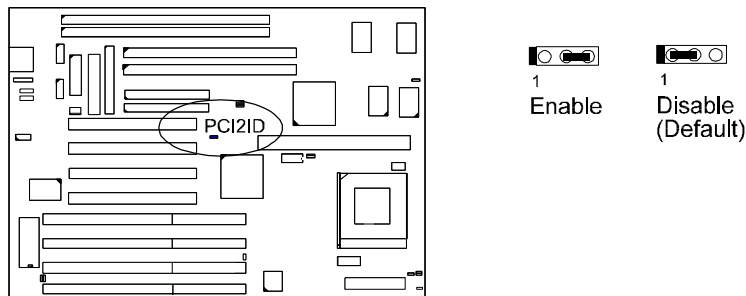

**NOTE :** Please be aware that this feature is only provided for reasons of convenience and it is only in rare cases that the user needs to alter the default setting. Please consult your dealer for further information.

***CPU to SRAM Data Transacting Mode Selection: SRAM3***

This jumper allows you to select the CPU to SRAM data read/write mode.

Also, you need to configure the Chipset feature, **Linear Bust Mode**, in Page 54. Please refer to it.

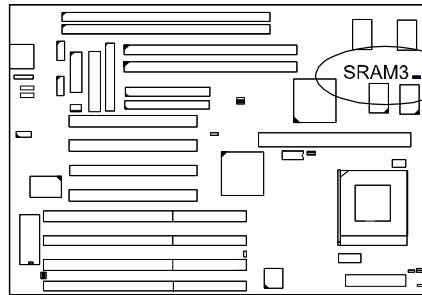

1  
Intel Burst  
(Default)  
For  
Intel Pentium CPUs,  
AMD-K5 CPUs,  
Cyrix CPUs,  
IBM CPUs



1  
Linear Burst  
  
For  
Cyrix CPUs,  
IBM CPUs  
***(Cache RAM Module  
must support  
linear burst mode)***

## 2). Install System Memory

### DRAM and SDRAM

The working space of the computer is the Random Access Memory (RAM). The system cannot act upon data unless it is loaded into RAM. When more memory is added, the working memory of the computer is larger, thereby increasing total performance.

The PA-2006's RAM is comprised of two industry standard 72-pin Single In-line Memory Modules (SIMMs) and two 168-pin Dual In-line Memory Modules (DIMMs). The SIMM sockets are able to support 8 to 256MB FPM (Fast Page Mode) and high-speed EDO (Extended Data Out) DRAM. Its DIMM sockets are able to support up to 128MB EDO DRAM and lightning-fast SDRAM (Synchronous DRAM).

SDRAM is an advanced new memory technology that boosts overall system performance with its ability to synchronize all operations with the processor clock signal. This makes the implementation of control interfaces easier, and speeds up column access time. SDRAM features an on-chip burst counter that can be utilized to increment column addresses for very fast burst accesses, which means that SDRAM allows new memory accesses to be initiated before the preceding access has been finished.

Before making DRAM upgrades you should verify the type and speed of the RAM currently installed from your dealer. Installing mixtures of RAM types other than those described in this manual, will have unpredictable results.

## RAM Modules Configuration

(Unit : MB)

| TOTAL MEMORY | SIMM2 BANK 2 | SIMM1 BANK 2 | DIM1 BANK 0 | DIM2 BANK 1 |
|--------------|--------------|--------------|-------------|-------------|
| 8            | 4            | 4            |             |             |
|              |              |              | 8           |             |
| 16           | 8            | 8            |             |             |
|              |              |              | 16          |             |
|              |              |              | 8           | 8           |
|              | 4            | 4            | 8           |             |
| 32           | 16           | 16           |             |             |
|              |              |              | 32          |             |
|              |              |              | 16          | 16          |
|              | 8            | 8            | 8           | 8           |
|              | 8            | 8            | 16          |             |
| 40           | 4            | 4            | 16          | 16          |
|              | 4            | 4            | 32          |             |
|              | 16           | 16           | 8           |             |
| 48           | 8            | 8            | 16          | 16          |
|              | 8            | 8            | 32          |             |
|              | 16           | 16           | 16          |             |
| 64           | 32           | 32           |             |             |
|              |              |              | 64*         |             |
|              |              |              | 32          | 32          |
|              | 16           | 16           | 16          | 16          |
|              | 16           | 16           | 32          |             |

(continued on next page)

(continued)

| TOTAL MEMORY | SIMM2 BANK 2 | SIMM1 BANK 2 | DIM1 BANK 0 | DIM2 BANK 1 |
|--------------|--------------|--------------|-------------|-------------|
| 72           | 4            | 4            | 32          | 32          |
|              | 4            | 4            | 64*         |             |
|              | 32           | 32           | 8           |             |
| 80           | 8            | 8            | 32          | 32          |
|              | 8            | 8            | 64*         |             |
|              | 32           | 32           | 8           | 8           |
|              | 32           | 32           | 16          |             |
| 96           | 16           | 16           | 32          | 32          |
|              | 16           | 16           | 64*         |             |
|              | 32           | 32           | 16          | 16          |
|              | 32           | 32           | 32          |             |
| 128          | 32           | 32           | 32          | 32          |
|              | 32           | 32           | 64*         |             |
|              | 64           | 64           |             |             |
| 136          | 4            | 4            | 64*         | 64*         |
|              | 64           | 64           | 8           |             |
| 144          | 8            | 8            | 64*         | 64*         |
|              | 64           | 64           | 8           | 8           |
|              | 64           | 64           | 16          |             |
| 160          | 16           | 16           | 64*         | 64*         |
|              | 64           | 64           | 16          | 16          |
|              | 64           | 64           | 32          |             |
| 192          | 64           | 64           | 32          | 32          |
|              | 64           | 64           | 64*         |             |
|              | 32           | 32           | 64*         | 64*         |

(continued on next page)

(continued)

| TOTAL MEMORY | SIMM2 BANK 2 | SIMM1 BANK 2 | DIM1 BANK 0 | DIM2 BANK 1 |
|--------------|--------------|--------------|-------------|-------------|
| 256          | 64           | 64           | 64*         | 64*         |
| 264          | 128*         | 128*         | 8           |             |
| 272          | 128*         | 128*         | 8           | 8           |
|              | 128*         | 128*         | 16          |             |
| 288          | 128*         | 128*         | 16          | 16          |
|              | 128*         | 128*         | 32          |             |
| 320          | 128*         | 128*         | 32          | 32          |
|              | 128*         | 128*         | 64*         |             |
| 384          | 128*         | 128*         | 64*         | 64*         |

|   |
|---|
| <p><b>NOTE :</b></p> <ol style="list-style-type: none"> <li>* A RAM module of this size was not available for testing when this manual was printed.</li> <li>DIM1 and DIM2 only support 3.3V (unbuffer) EDO and SDRAM modules.</li> </ol> |
|---|



## Install SIMMs

Complete the following procedures to install SIMMs:

**CAUTION** : Always turn the system power off before installing or removing any device; and see “Handling Precautions” at the start of this manual.

1. Locate the SIMM slots on the mainboard. (See figure below.)

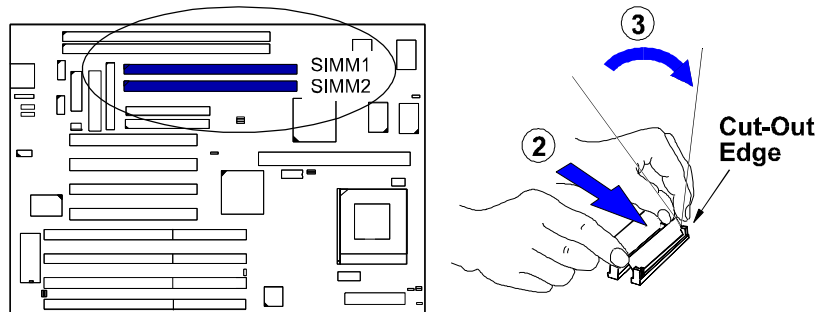

**NOTE** : SIMMs in each bank must be of the same type; and the BIOS automatically configures the memory size.

2. Carefully fit a SIMM at a 45 degree angle into each empty sockets to be populated. All the SIMMs must face the same direction.
3. Swing each SIMM into its upright, locked position.  
When locking a SIMM in place, push on each end of the SIMM - do not push in the middle, as shown above.

## Remove SIMMs

To remove the SIMMs, pull the retaining latch on both ends of the socket and reverse the procedure above.

## Install DIMMs

Complete the following procedures to install DIMMs:

1. Locate the DIMM slots on the mainboard. (See figure below.)

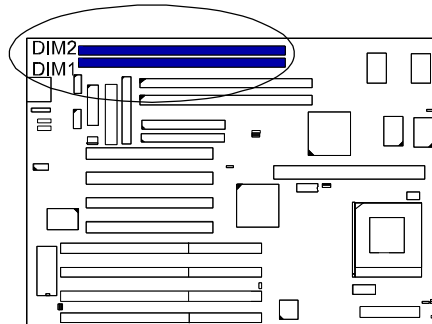

2. Carefully insert the DIMM straight down onto the DIMM slot with both hands until the clips on the ends of the slot close up to hold the DIMM in place.

## Remove DIMMs

Press the clips on the ends of the slot simultaneously. The DIMMs will spring out easily.

## Cache Memory

The PA-2006 comes with onboard 256KB/512KB synchronous 3V Pipeline Burst SRAM, and one optional 256KB/512KB cache SRAM module (FIC's PB512K-3.0 is recommended\*) that can be installed on the cache SRAM module slot.

**NOTE :**

1. \* The specification of the cache SRAM module requires Intel Coast Standard version 3.X, such as FIC's PB512K-3.0.
2. If this mainboard supports a Cyrix 6x86-P200+ or an IBM 6x86-P200+ processor, two 64K x 32 cache SRAMs are onboard, the cache SRAM module is not necessary and the jumper SRAM3 is wired by the factory. Please refer to page 27.

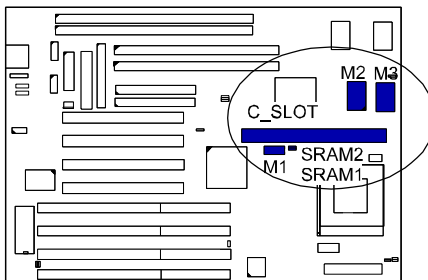

### Install Cache SRAM Module

1. Locate the C\_SLOT on the mainboard. (See figure above.)
2. Insert the cache SRAM module straight down onto the slot with both hands carefully.

## Onboard Cache SRAM (256KB/512KB)

**NOTE :** Use the correct chips for the amount of cache memory you want to add. Install both the correct Cache and Tag SRAM.

### 256KB

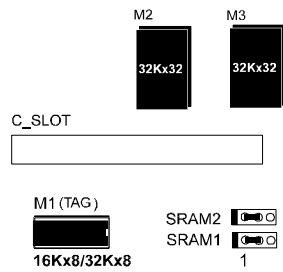

### 512KB

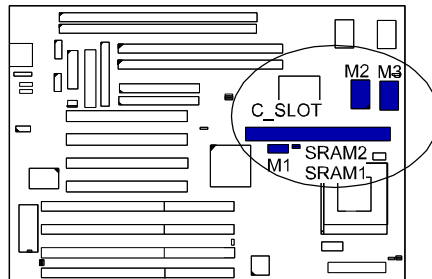
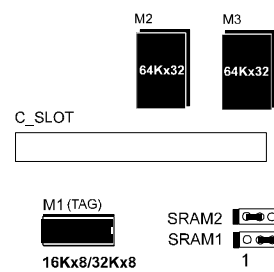

## Onboard Cache SRAM and SRAM Module Mixture (512KB/1MB)

**NOTE :** Use the correct chips for the amount of cache memory you want to add. Install both the correct Cache and Tag SRAM.

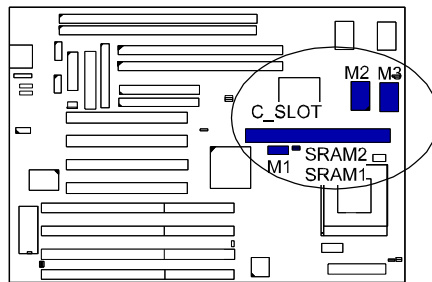
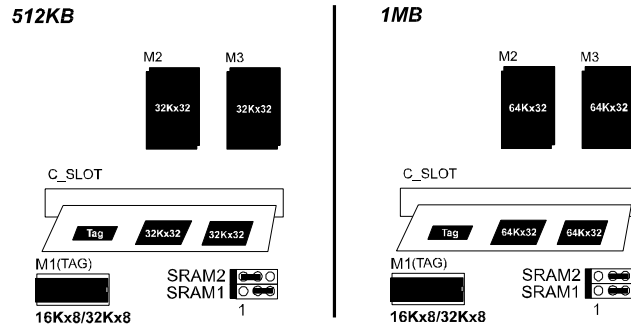

### SRAM Module (256KB/512KB)

**NOTE :** Use the correct chips for the amount of cache memory you want to add. Install both the correct Cache and Tag SRAM.

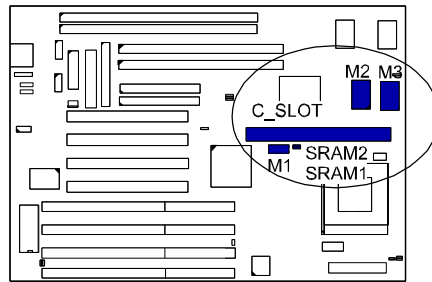
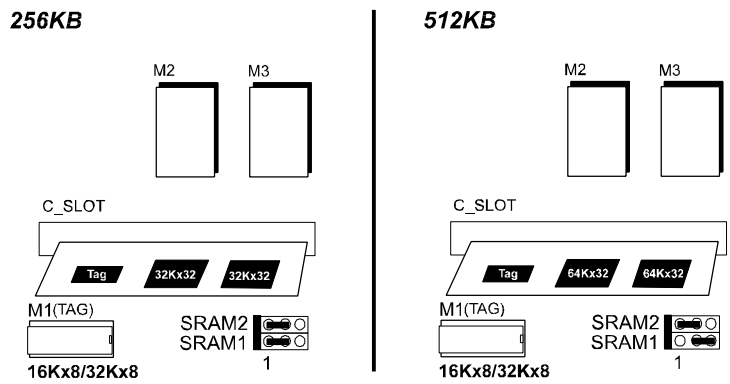

### 3). Install the CPU

The CPU module resides in the Zero Insertion Force (ZIF) socket on the mainboard.

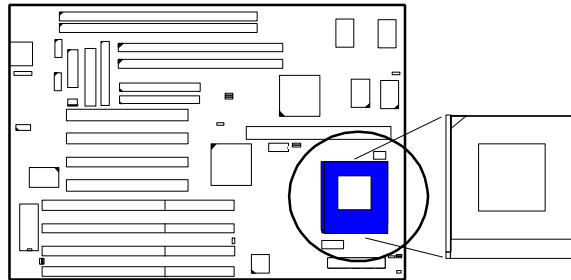

**CAUTION :**

1. Always turn the system power off before installing or removing any device.
2. Always observe static electricity precautions.  
See "Handling Precautions" at the start of this manual.
3. Inserting the CPU chip incorrectly may damage the chip.

To install the CPU, do the following:

1. Lift the lever on the side of the CPU socket.
2. Handle the chip by its edges and try not to touch any of the pins.
3. Place the CPU in the socket. The chip has a notch to correctly orientate the chip. Align the notch with pin one of the socket. Pin one locates around the triangular blank area. Do not force the chip. The CPU should slide easily into the socket.
4. Swing the lever to the down position to lock the CPU in place.
5. See the following sections for information on the CPU jumpers settings.

**CPU External Clock (Bus) Frequency: CLK1, CLK2, and CLK3**

The table below shows the jumper settings for the different CPU speed configurations.

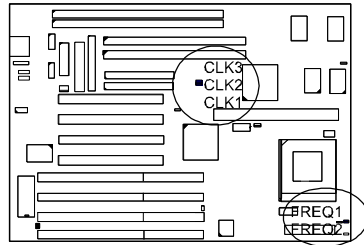

| System Clock | CLK1 | CLK2 | CLK3 * |
|--------------|------|------|--------|
| 75 MHz *     | 1    | 1    | 1      |
| 66 MHz       | 1    | 1    | 1      |
| 60 MHz       | 1    | 1    | 1      |
| 55 MHz       | 1    | 1    | 1      |
| 50 MHz       | 1    | 1    | 1      |

**NOTE : \***

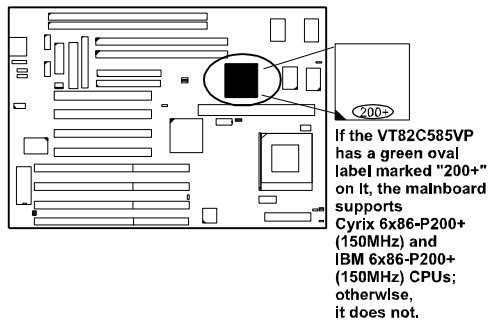

**CPU to Bus Frequency Ratio: FREQ1 and FREQ2**









































These two jumpers are used in combination to decide the ratio of the internal frequency of the CPU to the bus clock.

| FREQ1 | FREQ2 | Ratio |                |        |     |
|-------|-------|-------|----------------|--------|-----|
|       |       | P54C  | P55C/<br>M2/K6 | K5     | M1  |
| 1     | 1     | 3 x   | 3 x            | 2 x    | 4 x |
| 1     | 1     | 2.5 x | 2.5 x          | 1.75 x | 1 x |
| 1     | 1     | 2 x   | 2 x            | 1.5 x  | 2 x |
| 1     | 1     | 1.5 x | 3.5 x          | 1.5 x  | 3 x |



## Intel Pentium CPUs

### Frequency

| CPU Speed | External (CPU/CLK) | CLK1  | CLK2  | CLK3  | CPU Clock Rate |   |   |
|-----------|--------------------|---|---|---|----------------|---|---|
|           |                    |   |   |   | Internal       | FREQ1   | FREQ2   |
| 200 MHz   | 66 MHz             |  1   |  1   |  1   | 3 x Ext.       |  1   |  1   |
| 166 MHz   | 66 MHz             |  1   |  1   |  1   | 2.5 x Ext.     |  1   |  1   |
| 150 MHz   | 60 MHz             |  1   |  1   |  1   | 2.5 x Ext.     |  1   |  1   |
| 133 MHz   | 66 MHz             |  1   |  1   |  1   | 2 x Ext.       |  1   |  1   |
| 120 MHz   | 60 MHz             |  1   |  1   |  1   | 2 x Ext.       |  1   |  1   |
| 100 MHz   | 66 MHz             |  1  |  1  |  1  | 1.5 x Ext.     |  1  |  1  |
| 90 MHz    | 60 MHz             |  1 |  1 |  1 | 1.5 x Ext.     |  1 |  1 |
| 75 MHz    | 50 MHz             |  1 |  1 |  1 | 1.5 x Ext.     |  1 |  1 |

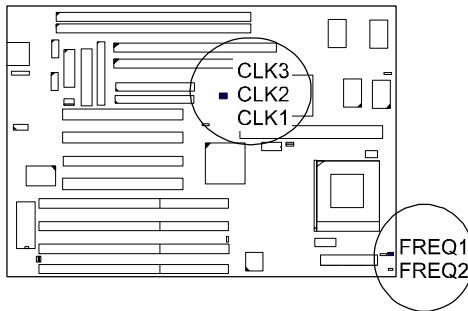

*Voltage*

VR1      VR2

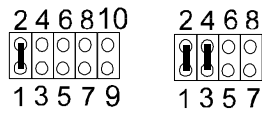

Core : 3.4V-3.6V  
IO : Same  
P54C VRE

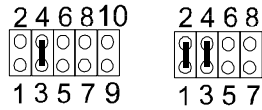

Core : 3.3V  
IO : Same  
P54C STD

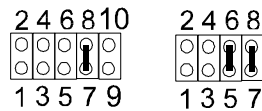

Core : 2.8V  
IO : 3.3V  
P55C

Intel Pentium CPU  
Bottom Side Marking

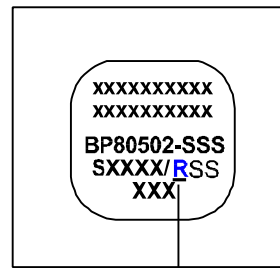





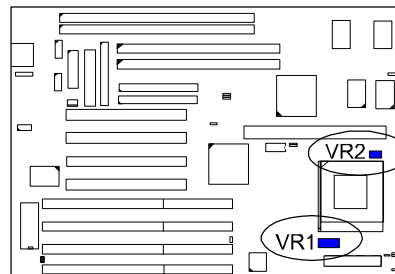

















































**R (Identifier for Voltage Range) :**

- V** for VRE Voltage Range
- or
- S** for Standard Voltage Range



## AMD-K5/K6 CPUs

### Frequency

| Model Name | CPU Speed | External (CPU/CLK) | CLK1  | CLK2  | CLK3  | CPU Clock Rate |   |   |
|------------|-----------|--------------------|---|---|---|----------------|---|---|
|            |           |                    |   |   |   | Internal       | FREQ1   | FREQ2   |
| K6-233     | 233 MHz   | 66 MHz             |  1   |  1   |  1   | 3.5 x          |  1   |  1   |
| K6-200     | 200 MHz   | 66 MHz             |  1   |  1   |  1   | 3 x            |  1   |  1   |
| K6-166     | 166 MHz   | 66 MHz             |  1   |  1   |  1   | 2.5 x          |  1   |  1   |
| K5-PR200   | 133 MHz   | 66 MHz             |  1   |  1   |  1   | 2 x            |  1   |  1   |
| K5-PR166   | 116 MHz   | 66 MHz             |  1   |  1   |  1   | 1.75 x         |  1   |  1   |
| K5-PR150   | 105 MHz   | 60 MHz             |  1   |  1   |  1   | 1.75 x         |  1   |  1   |
| K5-PR133   | 100 MHz   | 66 MHz             |  1  |  1  |  1  | 1.5 x          |  1  |  1  |
| K5-PR120   | 90 MHz    | 60 MHz             |  1 |  1 |  1 | 1.5 x          |  1 |  1 |
| K5-PR100   | 100 MHz   | 66 MHz             |  1 |  1 |  1 | 1.5 x          |  1 |  1 |
| K5-PR90    | 90 MHz    | 60 MHz             |  1 |  1 |  1 | 1.5 x          |  1 |  1 |
| K5-PR75    | 75 MHz    | 50 MHz             |  1 |  1 |  1 | 1.5 x          |  1 |  1 |

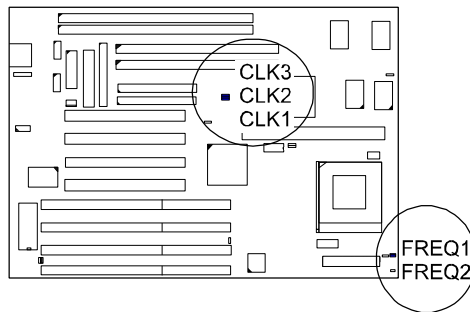

**Voltage**

VR1                  VR2

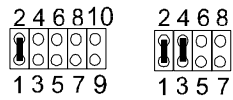

Core : 3.5V  
IO : Same  
AMD-K5 - B

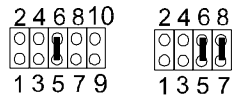

Core : 3.2V  
IO : 3.3V  
AMD-K6 (233 MHz)

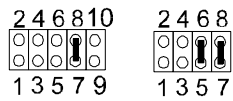

Core : 2.9V  
IO : 3.3V  
AMD-K6 (166, 200 MHz)

**AMD-K5 CPU  
Top Side Marking**

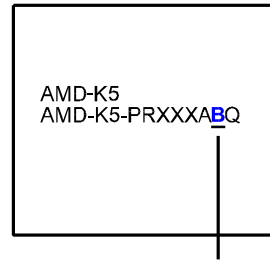

**V** (Identifier for Operation Voltage)



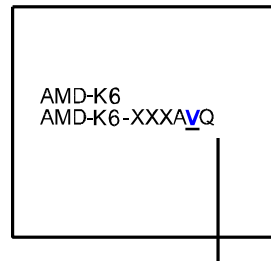



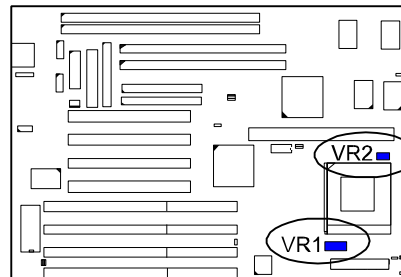















































**AMD-K6 CPU  
Top Side Marking**



**V** (Identifier for Operation Voltage) :  
**N** 3.1-3.3V Core/3.135-3.6V I/O  
**L** 2.755-3.045V Core/3.135-3.6V I/O



*Cyrix 6x86 CPUs  
Frequency*

| Model                       | CPU Speed | External (CPU/CLK) | CLK1  | CLK2  | CLK3  | CPU Clock Rate |   |   |
|-----------------------------|-----------|--------------------|---|---|---|----------------|---|---|
|                             |           |                    |   |   |   | Internal       | FREQ1   | FREQ2   |
| M2*                         | 233 MHz   | 66 MHz             |  1   |  1   |  1   | 3.5 x          |  1   |  1   |
| M2*                         | 225 MHz   | 75 MHz             |  1   |  1   |  1   | 3 x            |  1   |  1   |
| M2*                         | 200 MHz   | 66 MHz             |  1   |  1   |  1   | 3 x            |  1   |  1   |
| M2*                         | 187 MHz   | 75 MHz             |  1   |  1   |  1   | 2.5 x          |  1   |  1   |
| M2*                         | 180 MHz   | 60 MHz             |  1   |  1   |  1   | 3 x            |  1   |  1   |
| M2*                         | 166 MHz   | 66 MHz             |  1   |  1   |  1   | 2.5 x          |  1   |  1   |
| 6x86-PR200+<br>6x86L-PR200+ | 150 MHz   | 75 MHz             |  1   |  1   |  1   | 2 x            |  1   |  1   |
| 6x86-PR166+<br>6x86L-PR166+ | 133 MHz   | 66 MHz             |  1  |  1  |  1  | 2 x            |  1  |  1  |
| 6x86-PR150+<br>6x86L-PR150+ | 120 MHz   | 60 MHz             |  1 |  1 |  1 | 2 x            |  1 |  1 |
| 6x86-PR133+<br>6x86L-PR133+ | 110 MHz   | 55 MHz             |  1 |  1 |  1 | 2 x            |  1 |  1 |
| 6x86-PR120+<br>6x86L-PR120+ | 100 MHz   | 50 MHz             |  1 |  1 |  1 | 2 x            |  1 |  1 |

**NOTE :** \* This CPU had not been tested when this manual was printed.

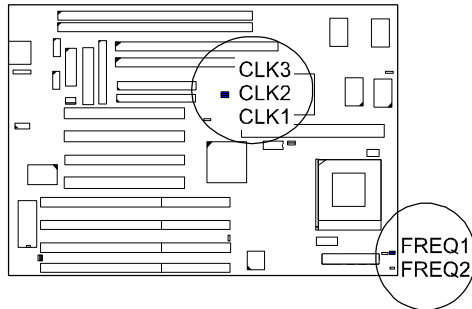

*Voltage*

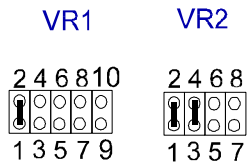

**Core : 3.4V-3.6V**  
**IO : Same**  
**Cyrix 6x86-028**

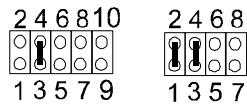

**Core : 3.3V**  
**IO : Same**  
**Cyrix 6x86-016**

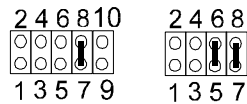

**Core : 2.8V**  
**IO : 3.3V**  
**Cyrix 6x86L\***

**Cyrix 6x86 CPU  
 Top Side Marking**

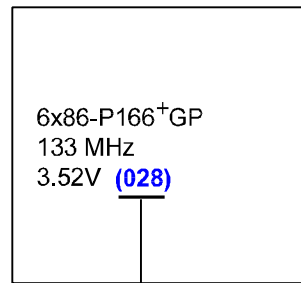





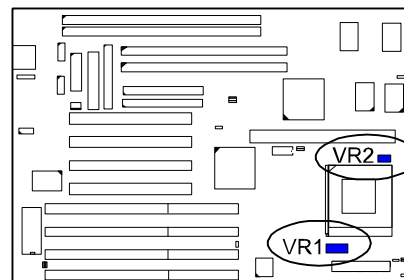

















































**(016) : 3.3V**  
**(028) : 3.52V**

**NOTE :** \* This CPU had not been tested when this manual was printed.



## IBM 6x86 CPUs

### Frequency

| Model                       | CPU Speed | External (CPU/CLK) | CLK1  | CLK2  | CLK3   | CPU Clock Rate |   |   |
|-----------------------------|-----------|--------------------|---|---|--|----------------|---|---|
|                             |           |                    |   |   |  | Internal       | FREQ1   | FREQ2   |
| M2*                         | 233 MHz   | 66 MHz             |  1   |  1   |  1   | 3.5 x          |  1   |  1   |
| M2*                         | 225 MHz   | 75 MHz             |  1   |  1   |  1   | 3 x            |  1   |  1   |
| M2*                         | 200 MHz   | 66 MHz             |  1   |  1   |  1   | 3 x            |  1   |  1   |
| M2*                         | 187 MHz   | 75 MHz             |  1   |  1   |  1   | 2.5 x          |  1   |  1   |
| M2*                         | 180 MHz   | 60 MHz             |  1   |  1   |  1   | 3 x            |  1   |  1   |
| M2*                         | 166 MHz   | 66 MHz             |  1   |  1   |  1   | 2.5 x          |  1   |  1   |
| 6x86-PR200+<br>6x86L-PR200+ | 150 MHz   | 75 MHz             |  1  |  1  |  1  | 2 x            |  1  |  1  |
| 6x86-PR166+<br>6x86L-PR166+ | 133 MHz   | 66 MHz             |  1 |  1 |  1 | 2 x            |  1 |  1 |
| 6x86-PR150+<br>6x86L-PR150+ | 120 MHz   | 60 MHz             |  1 |  1 |  1 | 2 x            |  1 |  1 |
| 6x86-PR133+<br>6x86L-PR133+ | 110 MHz   | 55 MHz             |  1 |  1 |  1 | 2 x            |  1 |  1 |
| 6x86-PR120+<br>6x86L-PR120+ | 100 MHz   | 50 MHz             |  1 |  1 |  1 | 2 x            |  1 |  1 |

**NOTE :** \* This CPU had not been tested when this manual was printed.

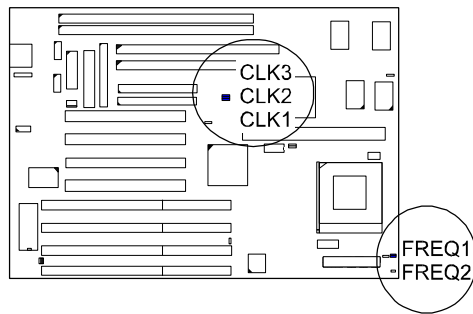

**Voltage**

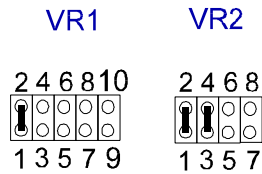

**Core : 3.4V-3.6V**  
**IO : Same**  
**IBM 6x86-028**

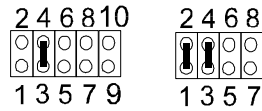

**Core : 3.3V**  
**IO : Same**  
**IBM 6x86-016**

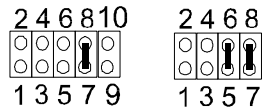

**Core : 2.8V**  
**IO : 3.3V**  
**IBM 6x86L \***

**IBM 6x86 CPU  
 Top Side Marking**

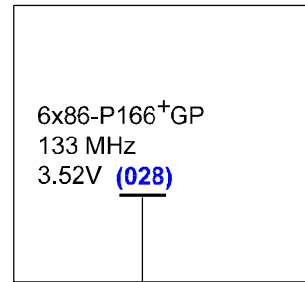

**(016) : 3.3V**

**(028) : 3.52V**

**NOTE : \* This CPU had not been tested when this manual was printed.**

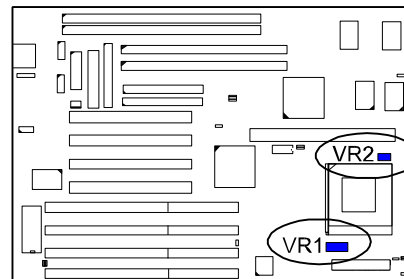



## Installation of Cyrix (or IBM) 6x86 CPU Fan

**CAUTION** : When you install a Cyrix (or IBM) 6x86 CPU fan, please pay attention to the direction of the air flow. Make sure the air flow is the direction of the regulator; otherwise, the system may overheat.

- 1). Supplier : BIRCHTECK, Taiwan (Phone : 886-2-7935677)  
Model Number - BEC6x86B2.
- 2). Supplier : Cyrix (or IBM). The fan comes with the Cyrix (or IBM) 6x86 CPU purchase. For the stable system performance, make sure that the air flow blow toward the regulator the temperature of the regulator.

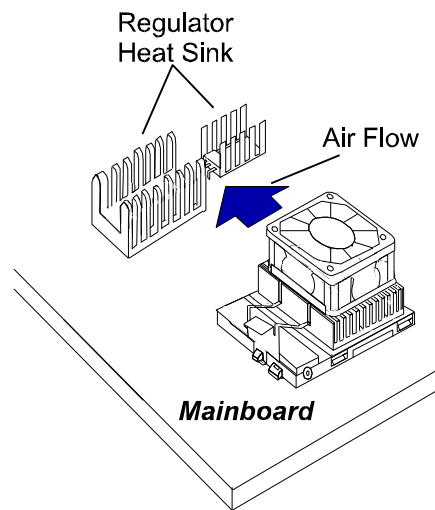

## 4). Install Expansion Cards

Your PA-2006 features four 16-bit ISA Bus and four 32-bit PCI Bus expansion slots.

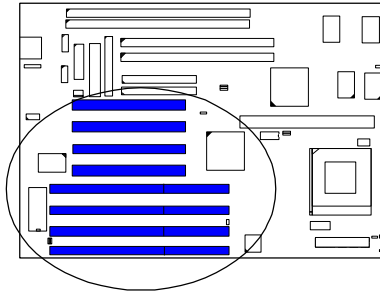

This section describes how to connect an expansion card to one of your system's expansion slots. Expansion cards are printed circuit boards that, when connected to the mainboard, increase the capabilities of your system. For example, expansion cards can provide video and sound capabilities.

|   |
|---|
| <p><b>CAUTION :</b></p> <ol style="list-style-type: none"><li>1. Always turn the system power off before installing or removing any device.</li><li>2. Always observe static electricity precautions.<br/>See "Handling Precautions" at the start of this manual.</li></ol> |
|---|

To install an expansion card, do the following:

1. Remove the chassis cover and select an empty expansion slot.
2. Remove the corresponding slot cover from the chassis.  
Unscrew the mounting screw that secures the slot cover and pull the slot cover out from the chassis. Keep the slot cover mounting screw nearby.

3. Holding the edge of the peripheral card, carefully align the edge connector with the expansion slot. (See figure below.)

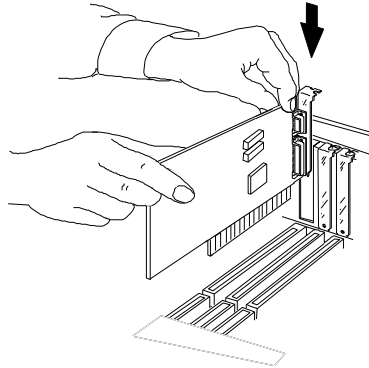

4. Push the card firmly into the slot. Push down on one end of the expansion card, then the other. Use this “rocking” motion until the add-in card is firmly seated inside the slot.
5. Secure the board with the mounting screw removed in Step 2. Make sure that the card has been placed evenly and completely into the expansion slot.

## 5). Connect Cables and Power Supply

### *Keyboard Connector: AT\_KB*

This 5-pin female connector is connected to your 101-key enhanced keyboard or 106-key Windows 95 keyboard.

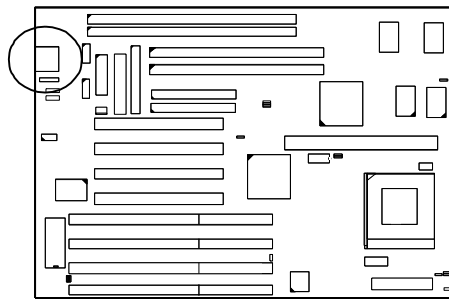

### *Serial Port Connector: COM1 and COM2*

These two 10-pin male connectors allow you to connect with your devices that take serial ports, such as a serial mouse or a modem. The COM2 Port on the mainboard can also be used as another IR Port. Usually, your serial mouse is attached to COM1. Your modem is linked to COM2. When you do not use the modem, you can set the BIOS to let COM2 be an IR port to save a dedicated SIR port.

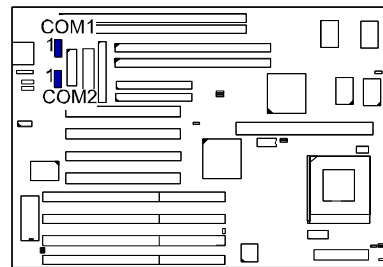

***CPU Fan Connector: FAN***

This connector is linked to the CPU fan.

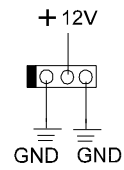
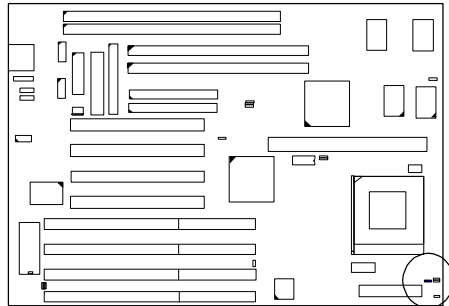

***Floppy Diskette Drive Connector: FLOPPY***

This 34-pin block connector connects to your floppy diskette drive (FDD) using the cable that is provided with this mainboard.

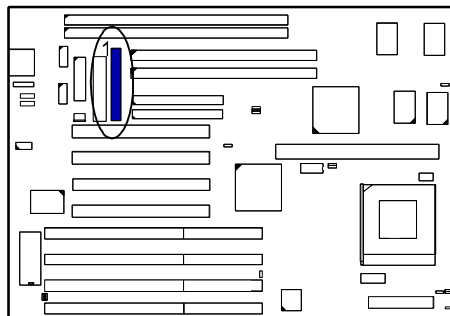

**Front Panel Block Connector: F\_PNL**

This block connector concludes : PW\_LED, KB\_LOCK, TB\_LED, SP\_SW, SPK, SP\_LED, IDE\_LED, RPW\_SW, and RST connectors.

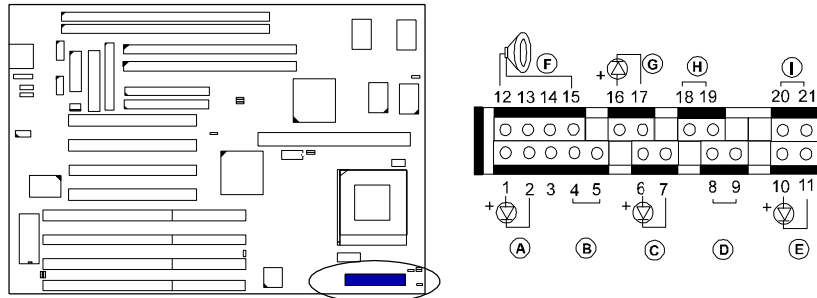

| Item | Connector | Pin Type   | Feature  |
|------|-----------|------------|--|
| A    | PW_LED    | 2-pin male | indicates the system power status                      |
| B    | KB_LOCK   | 2-pin male | allows the keyboard to access the system               |
| C    | TB_LED    | 2-pin male | indicates the system speed is in normal or turbo speed |
| D    | SP_SW     | 2-pin male | Suspend Mode switch                                    |
| E    | SP_LED    | 2-pin male | indicates the system into Suspend Mode when LED lit    |
| F    | SPK       | 4-pin male | connects to speaker                                    |
| G    | IDE_LED   | 2-pin male | indicates the IDE HDD I/O access LED lit               |
| H    | RPW_SW    | 2-pin male | Remote Power switch                                    |
| I    | RST       | 2-pin male | allows you to reset the system                         |

***Infrared Connector: IR***

This 10-pin male connector is used for connecting to the infrared (SIR) port and allows transmission of data to another system which also supports the SIR feature.

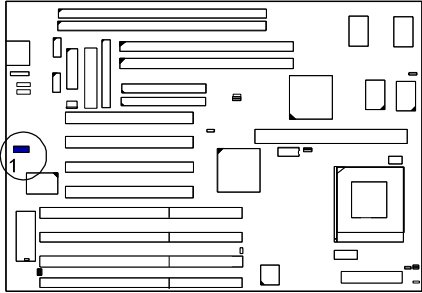

***Outlet Connector: OUTLET***

This 2-pin male connector links the system power supply for enabling (disabling) the power output from the direct connection of the system power supply. (This feature is designed for monitors without DPMS mode support, and only applies if the monitor is directly connected to the system power supply.)

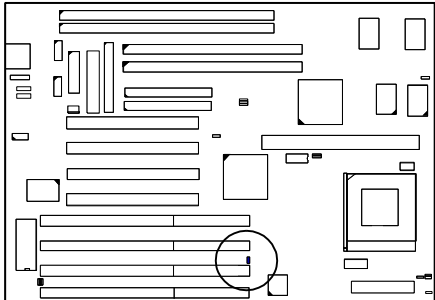

***Power Block Connector: POWER***

This 12-pin block connector is used for connecting to your standard 5V power supply. In the picture below, notice that, in most cases, there are two marks “P8” and “P9” on the surface of the connector. You have to insert the “P8” plug into the “P8” section of the connector, and so forth for “P9”. Two black wires must be in the middle.

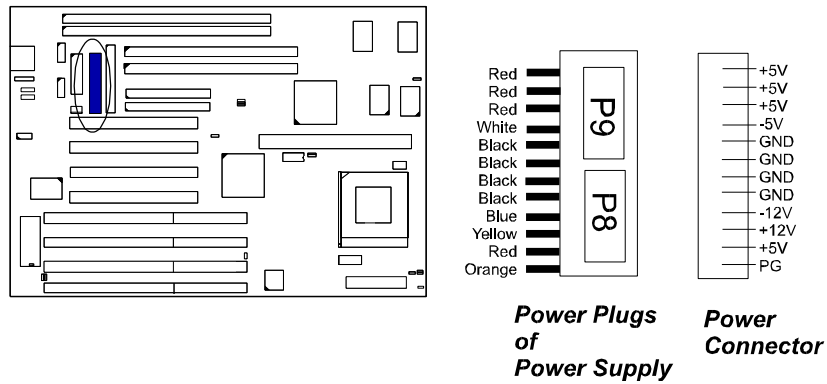



***IDE HDD Device Connector: PRIMARY and SECONDARY***

These two 40-pin block connectors are used for your IDE hard disks. If you have one IDE hard disk, connect it to the PRIMARY connector using the IDE HDD flat cable provided with the mainboard. The BIOS auto detection sets it to be a “Primary Master” disk. If you want to install another IDE hard disk or CD-ROM, please use the SECONDARY connector. If two hard disks are connected to the PRIMARY connector using the same cable, one of them is the master drive, the other one is the slave drive. You may need to set jumpers for the slave drive; please refer to the HDD manual for details.

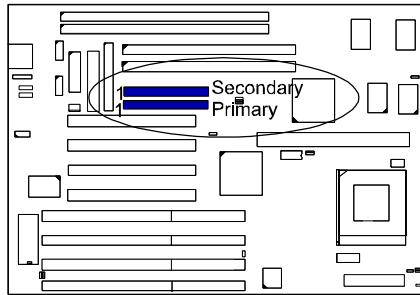

***Printer Block Connector: PRINTER***

This 26-pin male block connector is attached to your printer via a cable. When inserting the cable, please be sure that the red line is always on the same side as pin 1 of this connector.

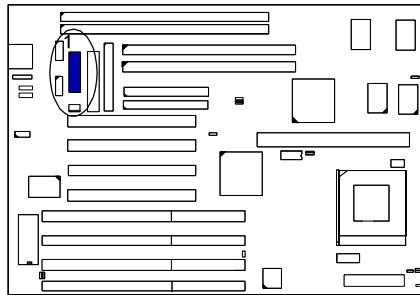

***Remote Power Connector: RPW\_CON***

This 3-pin male connector allows you to enable or disable the system power if the RPW\_SW is on or off.

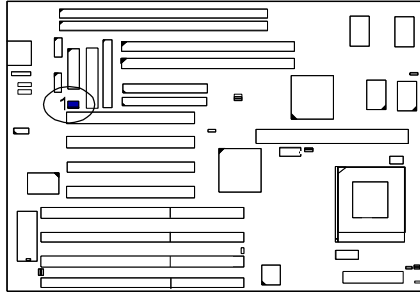

***Universal Serial Bus Connector: USB1 and USB2***

These two connectors are equipped for linking with the peripherals devices that support Universal Serial Bus connection.

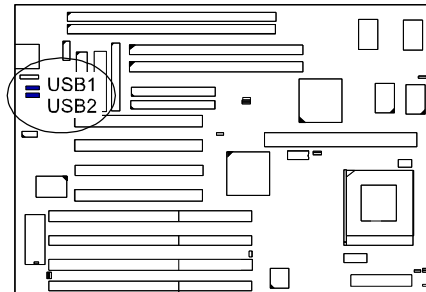

**This Page Intentionally Left Blank**



## Award BIOS Setup

The mainboard comes with the Award BIOS chip that contains the ROM Setup information of your system. This chip serves as an interface between the processor and the rest of the mainboard's components. This chapter explains the information contained in the Setup program and tells you how to modify the settings according to your system configuration.

### CMOS Setup Utility

|  |   |
|--|---|
| ROM PCI/ISA BIOS (2A5L9F09)<br>CMOS SETUP UTILITY<br>AWARD SOFTWARE, INC.  |   |
| STANDARD CMOS SETUP<br>BIOS FEATURES SETUP<br>CHIPSET FEATURES SETUP<br>POWER MANAGEMENT SETUP<br>PCI CONFIGURATION SETUP<br>LOAD BIOS DEFAULTS<br>LOAD SETUP DEFAULTS | PNP CONFIGURATION SETUP<br>SUPERVISOR PASSWORD<br>USER PASSWORD<br>IDE HDD AUTO DETECTION<br>SAVE & EXIT SETUP<br>EXIT WITHOUT SAVING |
| ESC : Quit<br>F10 : Save & Exit Setup  | ↑ ↓ → ← : Select Item<br>(Shift) F2 : Change Color  |
| Time, Date, Hard Disk Type...  |   |

A Setup program, built into the system BIOS, is stored in the CMOS RAM that allows the configuration settings to be changed. This program is executed when the user changes system configuration; the user changes system backup battery; or the system detects a configuration error and asks the user to run the Setup program. At power-on RAM testing, the message **Press DEL to enter Setup** appears. Use the arrow keys to select and press Enter to run the selected program.

## Standard CMOS Setup

| ROM PCI/ISA BIOS (2A5L9F09)<br>STANDARD CMOS SETUP<br>AWARD SOFTWARE, INC. |        |      |                          |      |         |                    |                        |      |      |
|--|--------|------|--------------------------|------|---------|--------------------|------------------------|------|------|
| Date (mm:dd:yy) : Wed, May 8 1996<br>Time (hh:mm:ss) : 15 : 38 : 56        |        |      |                          |      |         |                    |                        |      |      |
| HARD DISKS   | TYPE   | SIZE | CYLS                     | HEAD | PRECOMP | LANDZ              | SECTOR                 | MODE |      |
| Primary Master   | : Auto | 0    | 0                        | 0    | 0       | 0                  | 0                      | 0    | Auto |
| Primary Slave  | : Auto | 0    | 0                        | 0    | 0       | 0                  | 0                      | 0    | Auto |
| Secondary Master   | : Auto | 0    | 0                        | 0    | 0       | 0                  | 0                      | 0    | Auto |
| Secondary Slave  | : Auto | 0    | 0                        | 0    | 0       | 0                  | 0                      | 0    | Auto |
| Drive A : 1.44M, 3.5 In.   |        |      |                          |      |         |                    | Base Memory: 640K      |      |      |
| Drive B : None   |        |      |                          |      |         |                    | Extended Memory: 7168K |      |      |
| Video : EGA/VGA  |        |      |                          |      |         |                    | Other Memory: 384K     |      |      |
| Halt On : All Errors   |        |      |                          |      |         |                    | Total Memory: 8192K    |      |      |
| ESC : Quit   |        |      | ↑ ↓ → ← : Select Item    |      |         | PU/PD/+/- : Modify |                        |      |      |
| F1 : Help  |        |      | (Shift)F2 : Change Color |      |         |                    |                        |      |      |

The Standard CMOS Setup screen is displayed above. System BIOS automatically detects memory size, thus no changes are necessary. It has a few items for setting. Each item may have one or more option settings. It allows you to change the system Date and Time, IDE hard disk, floppy disk drive types for drive A: and B:, boot up video display mode, and POST error handling selection. Use the arrow keys to highlight the item and then use the PgUp, or PgDn keys to select the value you want in each item.

## Hard Disk Configurations

### TYPE:

Select from 1 to 45 to fill remaining fields with predefined values of disk drives. Select User to fill the remaining fields. Select Auto to detect the HDD type automatically.

### SIZE:

The hard disk size. The unit is Mega Bytes.

### CYLS:

The cylinder number of the hard disk.

### HEAD:

The read/write head number of hard disk. The range is from 1 to 16.

**PRECOMP:**

The cylinder number at which the disk drive changes the write timing.

**LANDZ:**

The cylinder number that the disk drive heads (read/write) are seated when the disk drive is parked.

**SECTOR:**

The sector number of each track defined on the hard disk. The range is from 1 to 64.

**MODE:**

Select Auto to detect the mode type automatically. If your hard disk supports the LBA mode, select LBA or Large. However, if your hard disk cylinder is more than 1024 and does not support the LBA function, you have to set at Large. Select Normal if your hard disk supporting cylinders is below 1024.

**Software Turbo Speed**

The BIOS supports Software Turbo Speed feature. Instead of pressing the Turbo Speed Button on the front panel, simply press the **Alt, Ctrl, and +** keys at the same time to enable the Turbo Speed feature; and press the **Alt, Ctrl, and -** keys at the same time to disable the feature.

## BIOS Features Setup

| ROM PCI/ISA BIOS (2A5L9F09)<br>BIOS FEATURES SETUP<br>AWARD SOFTWARE, INC. |  |
|--|--|
| Virus Warning : Disabled   | Video BIOS Shadow : Enabled                |
| CPU Internal Cache : Enabled   | C8000 - C8FFF Shadow : Disabled            |
| External Cache : Enabled   | CC000 - CFFFF Shadow : Disabled            |
| Quick Power On Self Test : Disabled  | D0000 - D3FFF Shadow : Disabled            |
| Boot Sequence : A, C   | D4000 - D7FFF Shadow : Disabled            |
| Swap Floppy Drive : Disabled   | D8000 - DBFFF Shadow : Disabled            |
| Boot Up Floppy Seek : Enabled  | DC000 - DFFFF Shadow : Disabled            |
| Boot Up NumLock Status : On  |  |
| Port 82H Fast A20G : Fast  |  |
| Typeomatic Rate Setting : Disabled   |  |
| Typeomatic Rate (Chars/Sec) : 6  |  |
| Typeomatic Delay (Msec) : 250  |  |
| Security Option : Setup  | ESC : Quit           ↑ ↓ → ← : Select Item |
| PCI/VGA Palette Snoop : Disabled   | F1 : Help            PU/PD,+/- : Modify    |
| OS Select For DRAM > 64MB : Non-OS2  | F5 : Old Values   (Shift) F2 : Color       |
|  | F6 : Load BIOS Defaults                    |
|  | F7 : Load Setup Defaults                   |

Moving around the BIOS and Chipset Features (refer to the next section) Setup programs shown works the same way as moving around the Standard CMOS Setup program. Users are not encouraged to run the BIOS and Chipset Features Setup programs. Your system should have been fine-tuned before shipping. Improper Setup may cause the system to fail, consult your dealer before making any changes.

### Virus Warning

When enabled, assigns the BIOS to monitor the master boot sector and the DOS boot sector of the first hard disk drive.  
The options are: Enabled, Disabled (Default).

### CPU Internal Cache

When enabled, improves the system performance. Disable this item when testing or trouble-shooting.  
The options are: Enabled (Default), Disabled.

### External Cache

When enabled, supports an optional cache SRAM.  
The options are: Enabled (Default), Disabled.

### Quick Power On Self Test

When enabled, allows the BIOS to bypass the extensive memory test.  
The options are: Enabled, Disabled (Default).



### Boot Sequence

Allows the system BIOS to first try to boot the operating system from the selected disk drive.

The options are: A, C (Default); C, A; C, CDROM, A; CDROM, C, A.

### Swap Floppy Drive

When enabled, allows you to switch the order in which the operating system accesses the floppy drives during boot up.

The options are: Enabled, Disabled (Default).

### Boot Up Floppy Seek

When enabled, assigns the BIOS to perform floppy diskette drive tests by issuing the time-consuming seek commands.

The options are: Enabled (Default), Disabled.

### Boot Up Numlock Status

When set to On, allows the BIOS to automatically enable the Num Lock Function when the system boots up.

The options are: On (Default), Off.

### Port 92H Fast A20G

When enabled, allows the A20G bus line signal generated from the chipset 82C586 PC/AT to directly pass to port 92H, instead of the keyboard controller. It will speed up the system performance.

The options are: Fast (Default), Normal.

### Typematic Rate Setting

The term typematic means that when a keyboard key is held down, the character is repeatedly entered until the key is released. When this item is enabled, you may change the typematic repeat rate.

The options are: Disabled (Default), Enabled.

### Typematic Rate (Chars/Sec)

Sets the rate of a character repeat when the key is held down.

The options are: 6 (Default), 8, 10, 12, 15, 20, 24, 30.

### Typematic Delay (Msec)

Sets the delay time before a character is repeated.

The options are: 250 (Default), 500, 750, 1000 millisecond.

### Security Option

Allows you to set the security level of the system.  
The options are: Setup (Default), System.

### PCI/VGA Palette Snoop

When enabled, allows you install an enhanced graphics adapter card. If your graphics adapter card does not support the Palette Snoop function, please set at Disable to avoid system malfunctions.  
The options are: Enabled, Disabled (Default).

### OS Select For DRAM > 64MB

If your operating system (OS) is OS2, select the options “OS2”; otherwise, stay with the default setting “Non-OS2”.  
The options are: Non-OS2 (Default), OS2.

### Video BIOS Shadow

When enabled, allows the BIOS to copy the video ROM code of the add-on video card to the system memory for faster access.  
The options are: Enabled (Default), Disabled.

### C8000-CBFFF to DC000-DFFFF Shadow

When enabled, allows the BIOS to copy the BIOS ROM code of the add-on card to system memory for faster access. It may improve the performance of the add-on card. Some add-on cards will not function properly if its BIOS ROM code is shadowed. To use these options correctly, you need to know the memory address range used by the BIOS ROM of each add-on card.  
The options are: Enabled, Disabled (Default).

## Chipset Features Setup

| ROM PCI/ISA BIOS (2A5L9F09)<br>CMOS SETUP UTILITY<br>CHIPSET FEATURES SETUP |            |                          |                       |
|---|------------|--------------------------|-----------------------|
| Video BIOS Cacheable  | : Enabled  | Onboard FDD Control      | : Enabled             |
| System BIOS Cacheable   | : Disabled | Onboard Serial Port 1    | : 3F8/IRQ4            |
| Memory Hole At 15Mb Addr.   | : Disabled | Onboard Serial Port 2    | : 2F8/IRQ3            |
|   |            | UART 2 Mode              | : Standard            |
| Sustained 3T write  | : Enabled  | Onboard Parallel Port    | : 378H/IRQ7           |
| CPU Pipeline  | : Enabled  | Onboard Parallel Mode    | : SPP                 |
| DRAM Timing Control   | : Fast     | OnChip USB               | : Disabled            |
| Enhanced Page Mode  | : Enabled  |                          |                       |
| Linear Burst Mode   | : Disabled |                          |                       |
| OnChip IDE first channel  | : Enabled  |                          |                       |
| OnChip IDE second channel   | : Enabled  | ESC : Quit               | ↑ ↓ → ← : Select Item |
| IDE Prefetch  | : Enabled  | F1 : Help                | PU/PD/+/- : Modify    |
| IDE HDD Block Mode  | : Enabled  | F5 : Old Values          | (Shift) F2 : Color    |
| IDE Primary Master PIO  | : Auto     | F6 : Load BIOS Defaults  |                       |
| IDE Primary Slave PIO   | : Auto     | F7 : Load Setup Defaults |                       |
| IDE Secondary Master PIO  | : Auto     |                          |                       |
| IDE Secondary Slave PIO   | : Auto     |                          |                       |

### Video BIOS Cacheable

When enabled, allows the system to use the video BIOS codes from SRAMs, instead of the slower DRAMs or ROMs.

The options are: Enabled (Default), Disabled.

### System BIOS Cacheable

When enabled, allows the ROM area F000H-FFFFH to be cacheable when cache controller is activated. The recommended setting is Disabled especially for high speed CPUs (200 MHz and above).

### Memory Hole At 15MB Addr.

When enabled, the memory hole at the 15MB address will be relocated to the 15~16MB address range of the ISA cycle when the processor accesses the 15~16MB address area.

When disabled, the memory hole at the 15MB address will be treated as a DRAM cycle when the processor accesses the 15~16MB address.

The options: Enabled, Disabled (Default).

### Sustained 3T Write

When enabled, allows the CPU to complete the memory writes in 3 clocks.

The options: Enabled (Default), Disabled.

### CPU Pipeline

When enabled, allows the CPU to execute the pipeline function.

The options: Enabled (Default), Disabled.

#### DRAM Timing Control

Allows you to speed up the data access of 82C586.  
The options: Normal, Fast (Default), Turbo.

#### Enhanced Page Mode

When enabled, it allows the system BIOS to pre-determine the next access is on or off page. This leads the start of precharge time if off page.  
The options: Enabled (Default), Disabled.

#### SDRAM Cycle Length

This feature appears only when SDRAM DIMM/s is installed (BIOS auto detection). If the CAS latency of your SDRAM DIMM is 2, set at 2 to enhance the system performance. If the CAS latency of your SDRAM DIMM is 3, stay with the default setting, 3.  
The options are: 2, 3 (Default).

#### SDRAM Bank Interleave

This feature appears only when SDRAM DIMM/s is installed (BIOS auto detection). When the bank interleave function of the SDRAM is enabled, its the data transacting performance is better than when it is disabled.  
The options are: Enabled (Default), Disabled.

#### Linear Burst Mode

When enabled, allows you to configure the CPU to SRAM data read/write mode. If you use a Cyrix CPU or an IBM CPU; and want to run it under the linear burst mode, select Enabled. If you use an Intel CPU, AMD-K5 CPU, Cyrix CPU (running the Intel Burst mode), IBM CPU (running the Intel Burst mode), please stay with the default value, Disabled. Please refer to Page 15, **SRAM3**.  
The options are: Enabled, Disabled (Default).

#### OnChip IDE First Channel

When enabled, allows the IDE drive to use the first channel of the primary IDE.  
The options: Enabled (Default), Disabled.

#### OnChip IDE Second Channel

When enabled, allows the IDE drive to use the second channel of the primary IDE.  
The options are: Enabled (Default), Disabled.

#### IDE Prefetch

When enabled, allows the BIOS to utilize the prefetch buffer of the onboard IDE controller to prefetch the next sequential data of the current access.

The options are: Enabled (Default), Disabled.

#### IDE HDD Block Mode

When enabled, allows the system to execute read/write requests to hard disk in block mode.

The options are: Enabled (Default), Disabled.

#### IDE Primary Master PIO

Allows you to select first PCI IDE channel of the primary master hard disk mode or to detect it by the BIOS.

The options are: Auto (Default), Mode 0, Mode 1, Mode 2, Mode 3, Mode 4.

#### IDE Primary Slave PIO

Allows you to select the first PCI IDE channel of the primary slave hard disk mode or to detect it by the BIOS.

The options are: Auto (Default), Mode 0, Mode 1, Mode 2, Mode 3, Mode 4.

#### IDE Secondary Master PIO

Allows you to select first PCI IDE channel of the primary master hard disk mode or to detect it by the BIOS.

The options are: Auto (Default), Mode 0, Mode 1, Mode 2, Mode 3, Mode 4.

#### IDE Secondary Slave PIO

Allows you to select the first PCI IDE channel of the primary slave hard disk mode or to detect it by the BIOS.

The options are: Auto (Default), Mode 0, Mode 1, Mode 2, Mode 3, Mode 4.

#### Onboard FDD Control

When enabled, the floppy diskette drive (FDD) controller is activated. The options are: Enabled (Default), Disabled.

#### Onboard Serial Port 1

If the serial port 1 uses the onboard I/O controller, you can modify your serial port parameters. If an I/O card needs to be installed, COM3 and COM4 may be needed.

The options are: 3F8/IRQ4 (Default), 3F8/IRQ4, 2E8/IRQ3, 2F8/IRQ3, Disabled.

#### Onboard Serial Port 2

If the serial port 2 uses the onboard I/O controller, you can modify your serial port parameters. If an I/O card needs to be installed, COM3 and COM4 may be needed.

The options are: 2F8/IRQ3 (Default), 3E8/IRQ4, 2E8/IRQ3, 3F8/IRQ4, Disabled.

#### UART 2 Mode

Allows you to select the IR modes if the serial port 2 is used as an IR port. Set at Standard, if you use COM2 as the serial port, instead as an IR port.

The options are: HPSIR, ASKIR, Standard (Default).

#### OnChip USB

The options are Disabled (default) and Enabled. If you connect an external USB device, please set at Enabled.

#### BIOS Support USB Keyboard

The options are Setup (default) and DOS. This item appears after the above item is set at Enabled. If your USB keyboard cannot be detected automatically by the system BIOS or some driver diskettes came with your USB keyboard, please set at DOS for allowing you to install the driver.

#### IR Function Duplex

If the option ASKIR of UART 2 Mode is selected, this feature will be shown in your monitor for allowing you to select the infrared transaction modes. The options are: Half (Default), Full.

#### RxD , TxD Active

Allows you to select the active level of the reception end (RxD) and transmission end (TxD). The Hi stands for Active, the Lo stands for Non-active.

The options are: Hi, Hi (Default); Hi, Lo; Lo, Hi; Lo, Lo.

#### Onboard Parallel Port

Allows you to select from a given set of parameters if the parallel port uses the onboard I/O controller.

The options are: 378H/IRQ7 (Default), 278H/IRQ5, 3BCH/IRQ7, Disabled.

#### Onboard Parallel Mode

Allows you to connect with an advanced printer I/O mode.

The options are: SPP (Default), EPP, ECP, ECP/EPP.

#### ECP Mode Use DMA 3

Allows you to select the DMA channel number 3 or 1 for the ECP printer mode.

The options are: 1, 3 (Default).

#### Parallel Port EPP Type

Allows you to select the EPP version.

The options are: EPP1.7, EPP1.9 (Default).

**IMPORTANT : I/O port 240h is reserved for the onboard Winbond I/O chip. Devices requiring I/O port address should not use port 240h.**

## Power Management Setup

| ROM PCI/ISA BIOS (2A5L9F09)<br>CMOS SETUP UTILITY<br>POWER MANAGEMENT SETUP |                                       |
|---|---------------------------------------|
| Power Management : Disable  | IRQ9 (IRQ2 Redir) : Primary           |
| PM Control by APM : Yes   | IRQ10 (Reserved) : Primary            |
| Video Off Option : Suspend -> Off   | IRQ11 (Reserved) : Primary            |
| Video Off Method : DPMS Support   | IRQ12 (PS/2 Mouse) : Primary          |
| MODEM Use IRQ : 3   | IRQ14 (Hard Disk) : Primary           |
|   | IRQ15 (Reserved) : Primary            |
| ** PM Timers **   |                                       |
| HDD Power Down : Disable  |                                       |
| Doze Mode : Disable   |                                       |
| Suspend Mode : Disable  |                                       |
| ** PM Events **   |                                       |
| VGA : OFF   |                                       |
| LPT & COM : LPT/COM   |                                       |
| HDD & FDD : ON  |                                       |
| IRQ3 (COM2) : Primary   | ESC : Quit      ↑ ↓ → ← : Select Item |
| IRQ4 (COM1) : Primary   | F1 : Help      PU/PD/+/- : Modify     |
| IRQ5 (LPT 2) : Primary  | F5 : Old Values (Shift) F2 : Color    |
| IRQ7 (LPT 1) : Primary  | F6 : Load BIOS Defaults               |
| IRQ8 (RTC Alarm) : Secondary  | F7 : Load Setup Defaults              |

### Power Management

When enabled, allows you to use Power Management features.

The options are: Enabled, Disabled (Default).

### PM Control by APM

The option No allows the BIOS to ignore the APM (Advanced Power Management) specification. Selecting Yes will allow the BIOS wait for APM's prompt before it enters Doze mode, Standby mode, or Suspend mode. If the APM is installed, it will prompt the BIOS to set the system into the power saving mode after all tasks are done.

The options are: Yes (Default), No.

### Video Off Option

This feature provides the selections of the video display power saving mode. The option Suspend - Off allows the video display to go blank if the system enters Suspend mode. The option All Modes - Off allows the video display to go blank if the system enters Doze mode or Suspend mode. The option Always On allows the video display to stay in Standby mode even when the system enters Doze or Suspend mode.

The options are: Suspend - Off (Default), All Modes - Off, Always On.



#### Video Off Method

The option V/H SYNC+Blank allows the BIOS to blank off screen display by turning off the V-Sync and H-Sync signals sent from add-on VGA card. DPMS Support allows the BIOS to blank off screen display by your add-on VGA card which supports DPMS (Display Power Management Signaling function.) Blank Screen allows the BIOS to blank screen display by turning off the red-green-blue signals.

The options are: DPMS Support (Default), V/H SYNC+Blank, Blank Screen.

#### MODEM Use IRQ

This feature allows you to select the IRQ# to meet your modem's IRQ#.

The options are: NA, 3 (Default), 4, 5,7, 9, 10, 11.

#### HDD Power Management

Selecting Disabled will turn off the hard disk drive (HDD) motor. Selecting 1 Min..15Min allows you to define the HDD idle time before the HDD enters Power Saving Mode. The option When Suspend lets the BIOS turn the HDD motor off when the system is in Suspend mode.

The options 1 Min..15Min and When Suspend will not work concurrently. When HDD is in Power Saving Mode, any access to the HDD will wake the HDD up.

The options are: Disabled (Default), 1 Min..15 Min, When Suspend.

#### Doze Mode

When disabled, the system will not enter Doze mode. The specified time option defines the idle time the system takes before it enters Doze mode.

The options are: Disabled (Default), 10, 20, 30, 40 sec, 1, 2, 4, 6, 8, 10, 20, 30, 40 min, 1h.

#### Suspend Mode

When disabled, the system will not enter Suspend mode. The specified time option defines the idle time the system takes before it enters Suspend mode.

The options are: Disabled (Default), 10, 20, 30, 40 sec, 1, 2, 4, 6, 8, 10, 20, 30, 40 min, 1h.

### VGA

Selecting ON will enable the power management timers when a no activity events is detected in the VGA. Selecting OFF to disable the PM timer even if a no activity event is detected.

The options are: OFF (Default), ON.

### LPT & COM

Selecting LPT & COM will enable the power management timers when a no activity event is detected in the LPT and COM ports. Selecting LPT (COM) will enable the power management timers when a no activity event is detected in the LPT (COM) ports. Selecting NONE to disable the PM timer even if a no activity event is detected.

The options are: LPT & COM (Default), LPT, COM, NONE.

### HDD & FDD

Selecting ON will enable the power management timers when a no activity event is detected in the hard disk drive and floppy disk drive. Selecting OFF to disable the PM timer even if a no activity event is detected.

The options are: OFF, ON (Default).

### IRQ# Activity

After the time period which you set at in Suspend Mode Feature, the system advances from Doze Mode to Suspend Mode in which the CPU clock stops and the screen display is off. At this moment, if the IRQ activity which is defined as Primary occurs, the system goes back to Full-on Mode directly.

If the IRQ activity which is defined as Secondary takes place, the system enters another low power state, Dream Mode, in which the system will act as Full-on Mode except that the screen display remains off until the corresponding IRQ handler finishes, then back to Suspend Mode.

For instance, if the system connects to a LAN and receives an interruption from its file server, the system will enter the dreaming mode to execute the corresponding calling routine.

The options are: Primary, Secondary. The default values of IRQ3, 4, 5, 7, 9, 10, 11, 12, 14, 15 are: Primary. The default value of IRQ8 is: Secondary.

|   |
|---|
| <p><b>NOTE</b> : Under certain operating system such as Windows NT 4.0 (Build 1381), the CD auto-insertion feature might have some effect on the power management. It is recommended that the CD-ROM drive to use the secondary channel, and set the following features in the feature Power Management Setup. - HDD &amp; FDD : Off ; IRQ15 (Reserved) : Secondary</p> |
|---|

## PCI Configuration Setup

| ROM PCI/ISA BIOS (2A5L9F09)<br>PCI CONFIGURATION SETUP<br>AWARD SOFTWARE, INC.  |   |
|---|---|
| PCI IRQ Activated By : Level<br>PCI IDE 2nd Channel : Enabled<br>PCI IDE IRQ Map To : PCI-AUTO<br>Primary IDE INT# : A<br>Secondary IDE INT# : B  | CPU to PCI Write Buffer : Enabled<br>PCI Dynamic Bursting : Enabled<br>PCI Burst : Enabled<br>PCI Master 0 WS Write : Enabled<br>Quick Frame Generation : Enabled |
| ESC : Quit                   ↑ ↓ → ← : Select Item<br>F1 : Help                   PU/PD +/- : Modify<br>F5 : Old Values           (Shift) F2 : Color<br>F6 : Load BIOS Defaults<br>F7 : Load Setup Defaults |   |

### PCI IRQ Activated By

If your IDE card is triggered by edge, set it at Edge.  
The options are: Level (Default), Edge.

### PCI IDE 2nd Channel

When enabled, allows you to use the second channel of PCI IDE.  
The options are: Enabled (Default), Disabled.

### PCI IDE IRQ Map To

Set to Auto to allow the system BIOS to automatically detect which interrupt is used by the PCI master drive.  
The options are: PCI-AUTO (Default), PCI-SLOT1, PCI-SLOT2, PCI-SLOT3, PCI-SLOT4, ISA.

### CPU to PCI Write Buffer

When enabled, allows data and address access to the internal buffer of 82C586 so the processor can be released from the waiting state.  
The options are: Enabled (Default), Disabled.

### PCI Dynamic Bursting

When enabled, the PCI controller allows Bursting PCI transfer if the consecutive PCI cycles come with the address falling in same 1KB space.  
This improves the PCI bus throughput.  
The options are: Enabled (Default), Disabled.

#### PCI Burst

When enabled, data transfer on PCI Buses will improve. Disable this item during trouble-shooting.

The options are: Disabled, Enabled (Default).

#### PCI Master 0 WS Write

When enabled, allows a zero-wait-state-cycle delay when the PCI master drive writes data to DRAM.

The options are: Enabled (Default), Disabled.

#### Quick Frame Generation

When enabled, allows the system to start the PCI Bus (by asserting frame) as soon as possible when the bus cycle is going to forward to the PCI Bus.

The options are: Disabled, Enabled (Default).

## PnP Configuration Setup

| ROM PCI/ISA BIOS (2A5L9F09)<br>PNP CONFIGURATION SETUP<br>AWARD SOFTWARE, INC.  |   |
|---|---|
| Resources Controlled By : Auto<br>Reset Configuration Data : Disabled   | PNP OS Installed : No<br>Assign IRQ For VGA : Enabled |
| ESC : Quit           ↑ ↓ → ← : Select Item<br>F1 : Help            PU/PD+/- : Modify<br>F5 : Old Values   (Shift) F2 : Color<br>F6 : Load BIOS Defaults<br>F7 : Load Setup Defaults |   |

### Resources Controlled By

If you set at Auto, the BIOS automatically arranges all system resources for you. If there are conflicts or you are not satisfy with the configuration, simply set all the resources listed in the above figure by selecting Manual.

The options are: Auto (default), Manual.

The manual options of IRQ- / DMA- assigned to are: Legacy ISA, PCI/ISA PnP.

### Reset Configuration Data

When enabled, this feature allows the system to clear the last BIOS configuration data and reset them with the default BIOS configuraton data.

The options are: Enabled, Disabled (default).

### PNP OS Installed

If the operating system (OS) you installed supports PNP (Plug-and-Play), such as Windows 95, please select Yes; otherwise, stay with the default value, Disabled.

The options are: No, Yes (default).

### Assign IRQ For VGA

If your PCI VGA card does not need an IRQ, select Disabled; therefore, an IRQ can be released for the system use.

The options are: Enabled (Default), Disabled.

## Load BIOS Defaults

The BIOS defaults contain the most appropriate values of the system parameters that allow minimum system performance. The OEM manufacturer may change the defaults through MODBIN before the binary image burns into the ROM.

## Load Setup Defaults

Selecting this field loads the factory defaults for BIOS and Chipset Features which the system automatically detects.

## Supervisor/User Password

To enable the Supervisor/User passwords, select the item from the Standard CMOS Setup. You will be prompted to create your own password. Type your password up to eight characters and press Enter. You will be asked to confirm the password. Type the password again and press Enter. You may also press Esc to abort the selection and not enter a password. To disable password, press Enter when you are prompted to enter password. A message appears, confirming the password is disabled.

Under the BIOS Feature Setup, if System is selected under the Security Option field and the Supervisor Password is enabled, you will be prompted for the Supervisor Password every time you try to enter the CMOS Setup Utility. If System is selected and the User Password is enabled, you will be requested to enter the User Password every time you reboot the system. If Setup is selected under the Security Option field and the User Password is enabled, you will be prompted only when you reboot the system.

## IDE HDD Auto Detection

The IDE Hard Disk Drive Auto Detection feature automatically configures your new hard disk. Use it for a quick configuration of new hard drives. This feature allows you to set the parameters of up to four IDE HDDs. The option(s) with (Y) is recommended by the system BIOS. You may also key in your own parameters instead of setting by the system BIOS. After all settings, press Esc key to return the main menu. For confirmation, enter the Standard CMOS Setup feature.

| ROM PCI/ISA BIOS (2A5L9F09)<br>STANDARD CMOS SETUP<br>AWARD SOFTWARE, INC.   |      |      |      |         |       |        |        |  |  |         |      |      |      |         |       |        |      |       |     |     |    |   |      |    |     |   |     |      |    |       |      |    |        |   |     |     |    |       |      |    |       |
|--|------|------|------|---------|-------|--------|--------|--|--|---------|------|------|------|---------|-------|--------|------|-------|-----|-----|----|---|------|----|-----|---|-----|------|----|-------|------|----|--------|---|-----|-----|----|-------|------|----|-------|
| HARD DISKS    TYPE    SIZE    CYLS    HEAD    PRECOMP    LANDZ    SECTOR    MODE   |      |      |      |         |       |        |        |  |  |         |      |      |      |         |       |        |      |       |     |     |    |   |      |    |     |   |     |      |    |       |      |    |        |   |     |     |    |       |      |    |       |
| Primary Master    :  |      |      |      |         |       |        |        |  |  |         |      |      |      |         |       |        |      |       |     |     |    |   |      |    |     |   |     |      |    |       |      |    |        |   |     |     |    |       |      |    |       |
| Select Primary Master    Option (N=Skip): N  |      |      |      |         |       |        |        |  |  |         |      |      |      |         |       |        |      |       |     |     |    |   |      |    |     |   |     |      |    |       |      |    |        |   |     |     |    |       |      |    |       |
| <table border="1"><thead><tr><th>OPTIONS</th><th>SIZE</th><th>CYLS</th><th>HEAD</th><th>PRECOMP</th><th>LANDZ</th><th>SECTOR</th><th>MODE</th></tr></thead><tbody><tr><td>2 (Y)</td><td>851</td><td>825</td><td>32</td><td>0</td><td>1650</td><td>63</td><td>LBA</td></tr><tr><td>1</td><td>852</td><td>1651</td><td>16</td><td>65535</td><td>1650</td><td>63</td><td>NORMAL</td></tr><tr><td>3</td><td>851</td><td>825</td><td>32</td><td>65535</td><td>1650</td><td>63</td><td>LARGE</td></tr></tbody></table> |      |      |      |         |       |        |        |  |  | OPTIONS | SIZE | CYLS | HEAD | PRECOMP | LANDZ | SECTOR | MODE | 2 (Y) | 851 | 825 | 32 | 0 | 1650 | 63 | LBA | 1 | 852 | 1651 | 16 | 65535 | 1650 | 63 | NORMAL | 3 | 851 | 825 | 32 | 65535 | 1650 | 63 | LARGE |
| OPTIONS  | SIZE | CYLS | HEAD | PRECOMP | LANDZ | SECTOR | MODE   |  |  |         |      |      |      |         |       |        |      |       |     |     |    |   |      |    |     |   |     |      |    |       |      |    |        |   |     |     |    |       |      |    |       |
| 2 (Y)  | 851  | 825  | 32   | 0       | 1650  | 63     | LBA    |  |  |         |      |      |      |         |       |        |      |       |     |     |    |   |      |    |     |   |     |      |    |       |      |    |        |   |     |     |    |       |      |    |       |
| 1  | 852  | 1651 | 16   | 65535   | 1650  | 63     | NORMAL |  |  |         |      |      |      |         |       |        |      |       |     |     |    |   |      |    |     |   |     |      |    |       |      |    |        |   |     |     |    |       |      |    |       |
| 3  | 851  | 825  | 32   | 65535   | 1650  | 63     | LARGE  |  |  |         |      |      |      |         |       |        |      |       |     |     |    |   |      |    |     |   |     |      |    |       |      |    |        |   |     |     |    |       |      |    |       |
| Note : Some OSes (like SCO-UNIX) must use "NORMAL" for installation  |      |      |      |         |       |        |        |  |  |         |      |      |      |         |       |        |      |       |     |     |    |   |      |    |     |   |     |      |    |       |      |    |        |   |     |     |    |       |      |    |       |

## Save and Exit Setup

|  |  |
|--|--|
| ROM PCI/ISA BIOS (2A5L9F09)<br>CMOS SETUP UTILITY<br>AWARD SOFTWARE, INC.  |  |
| STANDARD CMOS SETUP<br>BIOS FEATURES SETUP<br>CHIPSET FEATURES SETUP<br>POWER MANAGEMENT SETUP<br>PCI CONFIGURATION SETUP<br>LOAD BIOS | PNP CONFIGURATION SETUP<br>SUPERVISOR PASSWORD<br>USER PASSWORD<br>IDE HDD AUTO DETECTION<br>SAVE & EXIT SETUP<br>SAVE to CMOS and EXIT (Y/N)? Y |
| LOAD SETUP DEFAULTS  | ESC : Quit<br>F10 : Save & Exit Setup  |
| ↑ ↓ → ← : Select Item<br>(Shift) F2 : Change Color   |  |
| SAVE DATA TO CMOS and EXIT SETUP   |  |

After you have made changes under Setup, press Esc to return to the main menu. Move cursor to Save and Exit Setup or press F10 and then press Y to change the CMOS Setup. If you did not change anything, press Esc again or move cursor to Exit Without Saving and press Y to retain the Setup settings. The following message will appear at the center of the screen to allow you to save data to CMOS and exit the setup utility: **SAVE to CMOS and EXIT (Y/N)?**

## Exit without Saving

If you select this feature, the following message will appear at the center of the screen to allow you to exit the setup utility without saving CMOS modifications: **Quit Without Saving (Y/N)?**

**NOTE :** Default values of the various Setup items on this chapter may not be the same ones shown on your screen.



## **Application Note**

Below are some recommended configuration for the BIOS utility that will allow your mainboard to perform efficiently when using certain devices or when under a particular environment.

1. Page 56, Onboard Parallel Mode Feature:  
The I/O port 240h is reserved for the onboard Winbond I/O chip. Devices requiring the I/O port address should not use port 240h.
  
2. Page 59, IRQ# Activity Feature:  
Under certain operating systems such as Windows NT 4.0 (Build 1381), the CD auto-insertion feature might have some effect on the power management. It is recommended that the CD-ROM drive to use the secondary channel, and set the following features in the feature Power Management Setup -  
HDD & FDD : Off  
IRQ15 (Reserved) : Secondary.

**To : Users of Manual PA-2006**

(Part No. : 25-10580-08)

*The mainboards now support AMD-K6 series processors. The corresponding jumper settings are listed as below:*

VR1

VR2



Core: 2.9V  
IO : 3.3V

**AMD-K6 CPU  
Top Side Marking**

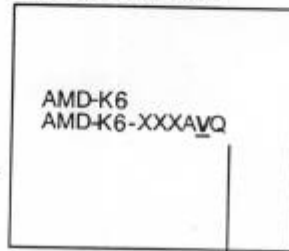























































**V (Identifier for Operation Voltage) :**

**N** 3.1-3.3V Core/3.135-3.6V I/O

**L** 2.755-3.045V Core/3.135-3.6V I/O

| Model Name | CPU Speed | External (CPU/CLK) | CLK1 | CLK2 | CLK3 | CPU Clock Rate |       |       |
|------------|-----------|--------------------|------|------|------|----------------|-------|-------|
|            |           |                    |      |      |      | Internal       | FREQ1 | FREQ2 |
| K6-200     | 200 MHz   | 66 MHz             |      |      |      | 3x             |       |       |
| K6-166     | 166 MHz   | 66 MHz             |      |      |      | 2.5x           |       |       |

**Cyrix 6x86 CPUs  
Frequency**

| Model                       | CPU Speed | External (CPU/CLK) | CLK1  | CLK2  | CLK3  | CPU Clock Rate |   |   |
|-----------------------------|-----------|--------------------|---|---|---|----------------|---|---|
|                             |           |                    |   |   |   | Internal       | FREQ1   | FREQ2   |
| M2*                         | 233 MHz   | 66 MHz             |  1   |  1   |  1   | 3.5 x          |  1   |  1   |
| M2*                         | 225 MHz   | 75 MHz             |  1   |  1   |  1   | 3 x            |  1   |  1   |
| M2*                         | 200 MHz   | 66 MHz             |  1   |  1   |  1   | 3 x            |  1   |  1   |
| M2*                         | 187 MHz   | 75 MHz             |  1   |  1   |  1   | 2.5 x          |  1   |  1   |
| M2*                         | 180 MHz   | 60 MHz             |  1   |  1   |  1   | 3 x            |  1   |  1   |
| M2*                         | 166 MHz   | 66 MHz             |  1   |  1   |  1   | 2.5 x          |  1   |  1   |
| 6x86-PR200+<br>6x86L-PR200+ | 150 MHz   | 75 MHz             |  1  |  1  |  1  | 2 x            |  1  |  1  |
| 6x86-PR166+<br>6x86L-PR166+ | 133 MHz   | 66 MHz             |  1 |  1 |  1 | 2 x            |  1 |  1 |
| 6x86-PR150+<br>6x86L-PR150+ | 120 MHz   | 60 MHz             |  1 |  1 |  1 | 2 x            |  1 |  1 |
| 6x86-PR133+<br>6x86L-PR133+ | 110 MHz   | 55 MHz             |  1 |  1 |  1 | 2 x            |  1 |  1 |
| 6x86-PR120+<br>6x86L-PR120+ | 100 MHz   | 50 MHz             |  1 |  1 |  1 | 2 x            |  1 |  1 |

**NOTE :** \* This CPU had not been tested when this manual was printed.

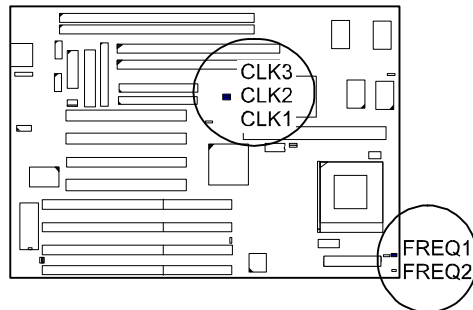

## Voltage

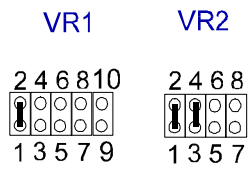

Core : 3.4V-3.6V  
 IO : Same  
 Cyrix 6x86-028

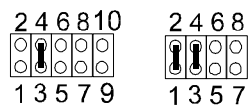

Core : 3.3V  
 IO : Same  
 Cyrix 6x86-016

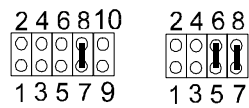

Core : 2.8V  
 IO : 3.3V  
 Cyrix 6x86L\*

### Cyrix 6x86 CPU Top Side Marking

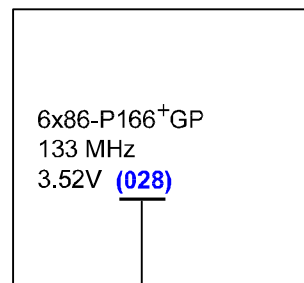

(016) : 3.3V





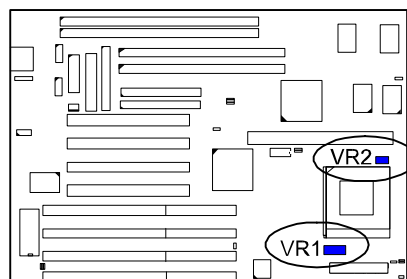

















































(028) : 3.52V

**NOTE :** \* This CPU had not been tested when this manual was printed.



## IBM 6x86 CPUs

### Frequency

| Model                       | CPU Speed | External (CPU/CLK) | CLK1  | CLK2  | CLK3  | CPU Clock Rate |   |   |
|-----------------------------|-----------|--------------------|---|---|---|----------------|---|---|
|                             |           |                    |   |   |   | Internal       | FREQ1   | FREQ2   |
| M2*                         | 233 MHz   | 66 MHz             |  1   |  1   |  1   | 3.5 x          |  1   |  1   |
| M2*                         | 225 MHz   | 75 MHz             |  1   |  1   |  1   | 3 x            |  1   |  1   |
| M2*                         | 200 MHz   | 66 MHz             |  1   |  1   |  1   | 3 x            |  1   |  1   |
| M2*                         | 187 MHz   | 75 MHz             |  1   |  1   |  1   | 2.5 x          |  1   |  1   |
| M2*                         | 180 MHz   | 60 MHz             |  1   |  1   |  1   | 3 x            |  1   |  1   |
| M2*                         | 166 MHz   | 66 MHz             |  1   |  1   |  1   | 2.5 x          |  1   |  1   |
| 6x86-PR200+<br>6x86L-PR200+ | 150 MHz   | 75 MHz             |  1 |  1 |  1 | 2 x            |  1 |  1 |
| 6x86-PR166+<br>6x86L-PR166+ | 133 MHz   | 66 MHz             |  1 |  1 |  1 | 2 x            |  1 |  1 |
| 6x86-PR150+<br>6x86L-PR150+ | 120 MHz   | 60 MHz             |  1 |  1 |  1 | 2 x            |  1 |  1 |
| 6x86-PR133+<br>6x86L-PR133+ | 110 MHz   | 55 MHz             |  1 |  1 |  1 | 2 x            |  1 |  1 |
| 6x86-PR120+<br>6x86L-PR120+ | 100 MHz   | 50 MHz             |  1 |  1 |  1 | 2 x            |  1 |  1 |

**NOTE :** \* This CPU had not been tested when this manual was printed.

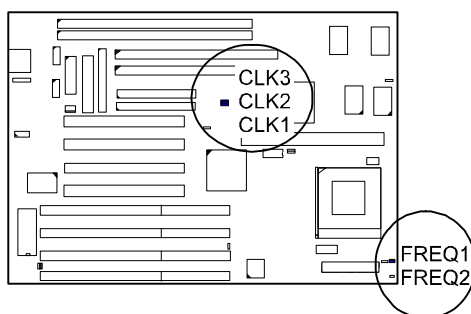

**Voltage**

VR1 VR2

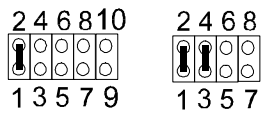

Core : 3.4V-3.6V  
IO : Same  
IBM 6x86-028

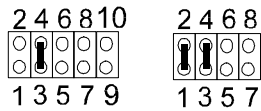

Core : 3.3V  
IO : Same  
IBM 6x86-016

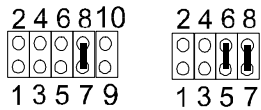

Core : 2.8V  
IO : 3.3V  
IBM 6x86L \*

**IBM 6x86 CPU  
Top Side Marking**

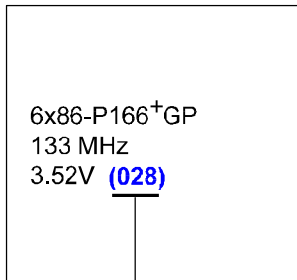

(016) : 3.3V

(028) : 3.52V

**NOTE : \* This CPU had not been tested**

when this manual was printed.

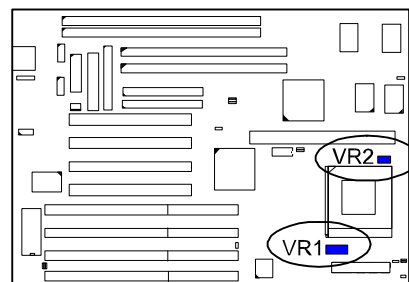

## Installation of Cyrix (or IBM) 6x86 CPU Fan

**CAUTION** : When you install a Cyrix (or IBM) 6x86 CPU fan, please pay attention to the direction of the air flow. Make sure the air flow is the direction of the regulator; otherwise, the system may overheat.

- 1). Supplier : BIRCHTECK, Taiwan (Phone : 886-2-7935677)  
Model Number - BEC6x86B2.
- 2). Supplier : Cyrix (or IBM). The fan comes with the Cyrix (or IBM) 6x86 CPU purchase. For the stable system performance, make sure that the air flow blow toward the regulator the temperature of the regulator.

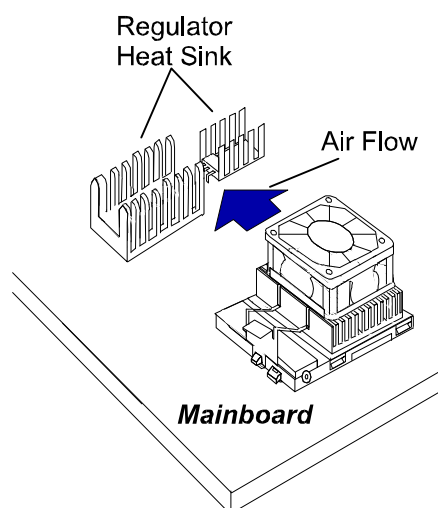

## 4). Install Expansion Cards

Your PA-2006 features four 16-bit ISA Bus and four 32-bit PCI Bus expansion slots.

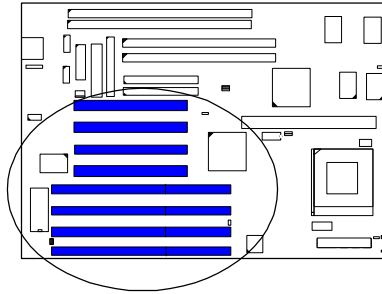

This section describes how to connect an expansion card to one of your system's expansion slots. Expansion cards are printed circuit boards that, when connected to the mainboard, increase the capabilities of your system. For example, expansion cards can provide video and sound capabilities.

**CAUTION :**

1. Always turn the system power off before installing or removing any device.
2. Always observe static electricity precautions.  
See "Handling Precautions" at the start of this manual.

To install an expansion card, do the following:

1. Remove the chassis cover and select an empty expansion slot.
2. Remove the corresponding slot cover from the chassis.  
Unscrew the mounting screw that secures the slot cover and pull the slot cover out from the chassis. Keep the slot cover mounting screw nearby.



3. Holding the edge of the peripheral card, carefully align the edge connector with the expansion slot. (See figure below.)

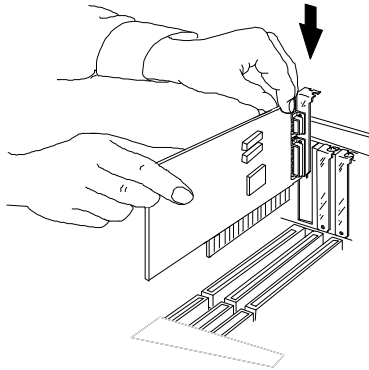

4. Push the card firmly into the slot. Push down on one end of the expansion card, then the other. Use this “rocking” motion until the add-in card is firmly seated inside the slot.
5. Secure the board with the mounting screw removed in Step 2. Make sure that the card has been placed evenly and completely into the expansion slot.

PA-2006 Motherboard

Item: Jumper settings for Pentium MMX 233MHz and 200MHz processors

Pentium MMX 233MHz

CPU Speed ---- 233 Mhz (66Mhz\*1.5x)

External(CPU/CLK) ---- 66 Mhz

CLK1 ----- 2&3 closed

CLK2 ----- 1&2 closed

CLK3 ----- 2&3 closed

FREQ1 ----- 1&2 closed

FREQ2 ----- 1&2 closed

VR1 ----- 5&6 closed (2.8V)

VR2 ----- 5&6,7&8 closed

And, since the board doesn't support 3.5V so this board should use

1.5V instead then the BIOS can recognize 233MMX.

Pentium MMX 200MHz

CPU Speed ---- 200 Mhz (66\*3)

External(CPU/CLK) ---- 66 Mhz

CLK1 ----- 2&3 closed

CLK2 ----- 1&2 closed

CLK3 ----- 2&3 closed

FREQ1 ----- 1&2 closed

FREQ2 ----- 2&3closed

VR1 ----- 7&8 closed (2.5V)

VR2 ----- 5&6,7&8 closed

-----  
FIC Technical Support