

# PA-2002



## MAINBOARD USER'S MANUAL

DOC No. : 14669

Revision : A0

Date : November, 1995

Part No. :

## HANDLING PRECAUTIONS

**† NOTE: Static electricity may cause damage to the integrated circuits on the mainboard. Before handling any mainboard outside of its protective packaging, ensure that there is no static electric charge in your body.  
Danger of explosion if battery is incorrectly replaced. Replace only with the same or equivalent type recommended by the manufacturer. Discard used batteries according to the manufacturer's instructions.**

Observe any or all of these basic precautions when handling the mainboard or other computer components:

- Wear a static wrist strap which fits around your wrist and is connected to a natural earth ground.
- Touch a grounded or anti-static surface or a metal fixture such as a water pipe.
- Avoid contact with the components on add-on cards, boards and modules and with the “**gold finger**” connectors plugged into the expansion slot. It is best to handle system components by their mounting bracket.

Above methods either prevent static build-up or cause it to be discharged properly.

### TRADEMARKS <sup>®</sup>

**IBM** registered trademark of International Business Machines Corp.

**Intel/Pentium** registered trademark of Intel Corp.

*All other trademarks mentioned in this manual are registered property of the respective owners.*

### COPYRIGHT ©

*This manual may not, in whole or in part, be photocopied, reproduced, transcribed, translated, or transmitted in whatsoever form without the written consent of the manufacturer, except for copies retained by the purchaser for personal archival purposes.*

## ABOUT THIS MANUAL

This manual is designed to guide you and facilitate your use of the PA-2002 mainboard. It contains a description of the design and features of the mainboard, and also includes useful information for changing the configuration of the board and the system it is installed in. The manual is divided into four chapters, which contain the main body of information normally referred to by users.

- Chapter 1** gives an overview of the mainboard and describes its major components and features.
- Chapter 2** gives information on the jumper settings on the mainboard.
- Chapter 3** provides information on the memory subsystem of the mainboard in the form of SIMMs and Cache memory and describes how you can upgrade memory.
- Chapter 4** briefly explains the mainboard's BIOS system setup in general and tells you how to run it and change the system configuration settings.

**+ NOTE:** The material in this manual is for information only and is subject to change without notice. We reserve the right to make changes in the product design without reservation and without notification to its users. We shall not be liable for technical or editorial omissions made herein; nor for incidental or consequential damages resulting from the furnishing, performance, or use of this material.

---

# Table of Contents

## Chapter 1 Overview

---

Main Features .....	2
Mainboard Layout .....	3
About Your Mainboard .....	4
The BIOS Setup Utility .....	4
IRQ Functionality .....	5
DMA Channels of ISA Cards .....	6
Enhanced IDE .....	6

## Chapter 2 Mainboard Settings

---

Jumpers .....	7
CPU Speed Select: JK1, JK2 .....	8
Bus/CPU Clock Speed: JC1, JC2 .....	8
CPU Voltage Mode Select: CPU_V .....	9
Password Clear: JCP .....	9
Power Supply Select: J1, J4 .....	10
Flash EPROM Type: J2 .....	10
TB_LED Mode Select: J3 .....	11
LPT Direction: JI .....	11
SRAM Mode Select: JSRAM .....	12
Hardware Reset: RESET .....	12

## Chapter 3 System Memory

---

Memory Locations .....	13
Installing DRAM .....	14
SIMM Banks .....	14

DRAM Configuration .....	14
Installation Instructions .....	15
Cache Memory .....	16
Installing Cache Memory .....	17

#### **Chapter 4 Award BIOS Setup**

---

CMOS Setup Utility .....	19
Standard CMOS Setup .....	20
BIOS Features Setup .....	22
Chipset Features Setup .....	25
Power Management Setup .....	29
PCI Configuration Setup .....	32
PnP Configuration Setup .....	34
Load BIOS Defaults .....	34
Load Setup Defaults .....	35
Supervisor/User Password .....	35
IDD HDD Auto Detection .....	35
Save and Exit Setup .....	36
Exit Without Saving .....	36

## Overview

The PA-2002 mainboard combines the advanced capabilities of the VIA Apollo Master chipset with a high-performance PCI local bus architecture to provide the ideal platform for unleashing the unsurpassed speed and power of the Intel Pentium processor.

This highly-flexible mainboard is designed to run a full range of Intel Pentium, AMD-K5, and Cyrix/IBM 6x86 processors. Any of these processors can be easily upgraded using its 321-pin ZIF (Zero Insertion Force) socket. The processor's advanced performance is complemented by a second level write back cache of up to 1MB and a main memory of up to 128MB RAM. The main memory is installed using the board's four 72-pin SIMM sockets that accept either standard Fast Page Mode, the new high-performance EDO (Extended Data-Out) DRAM, or more advanced BEDO (Burst EDO) DRAM.

The PA-2002 integrates a full set of I/O features onboard, including two 16550 UART compatible serial ports, one EPP/ECP capable parallel port, and one Floppy Disk Drive controller. It also comes with a built in Enhanced IDE controller that provides convenient, high-speed connections with up to four IDE devices, including Hard Disk and CD-ROM drives. Three 16-bit ISA slots and four 32-bit PCI slots provide ample room for further expansion.

This chapter gives a you a brief overview of the PA-2002 mainboard. In addition to basic information on the board's main components and features, it also provides advice on how to upgrade and expand it.

## **Main Features**

The PA-2002 mainboard comes with the following features:

- The onboard 321-pin ZIF socket supports Intel Pentium (P54C) CPU speed 75/90/100/120/133/150/166/200 MHz processors / P54CT / P55C (optional by splitting the voltage regulator).Cyrix/IBM 6x86-P120+ (100 MHz) / 6x86-P133+ (110 MHz) / 6x86-P150+ (120 MHz) / 6x86-P166+ (133 MHz) processors AMD K5-PR75 (75 MHz) / K5-PR90 (90 MHz) / K5-PR100 (100 MHz) / K5-PR120 (90 MHz) / K5-PR133 (100 MHz) / K5-PR150 (120 MHz) / K5-PR166 (133 MHz) processors.
- VIA Apollo Master chipset, including a CPU interface controller, advanced cache controller, integrated DRAM controller, synchronous ISA bus controller, PCI local bus interface, integrated power management unit.
- Supports 256KB/512KB/1MB standard 3.3V or mixed voltage asynchronous SRAM, or 256KB/512KB standard 3.3V synchronous SRAM direct-mapped write-back cache memory with cache module.
- Takes up to 128MB RAM in two banks using 72-pin SIMM modules of 4, 8, 16, or 32MB, with support for Fast Page Mode, EDO, and BEDO memory.
- Three 16-bit ISA expansion slots and four 32-bit PCI non-sharing expansion slots.
- Integrated Enhanced PCI local bus IDE controller with two connectors supports up to four IDE devices such as Hard Disk, CD-ROM or Tape Backup drives via two channels.
- Integrated Winbond W83787/787IF/877 Multi I/O chipset featuring two 16550 UART compatible serial ports one EPP/ECP capable parallel port, and one Floppy Disk Drive connector. Also, the WB83787IF and 83877 chipsets support infrared communication.
- Supports remote software power supply.
- Award BIOS with support for power management, Plug and Play and Enhanced IDE features.
- Supports 128KB Flash ROM.

## Mainboard Layout

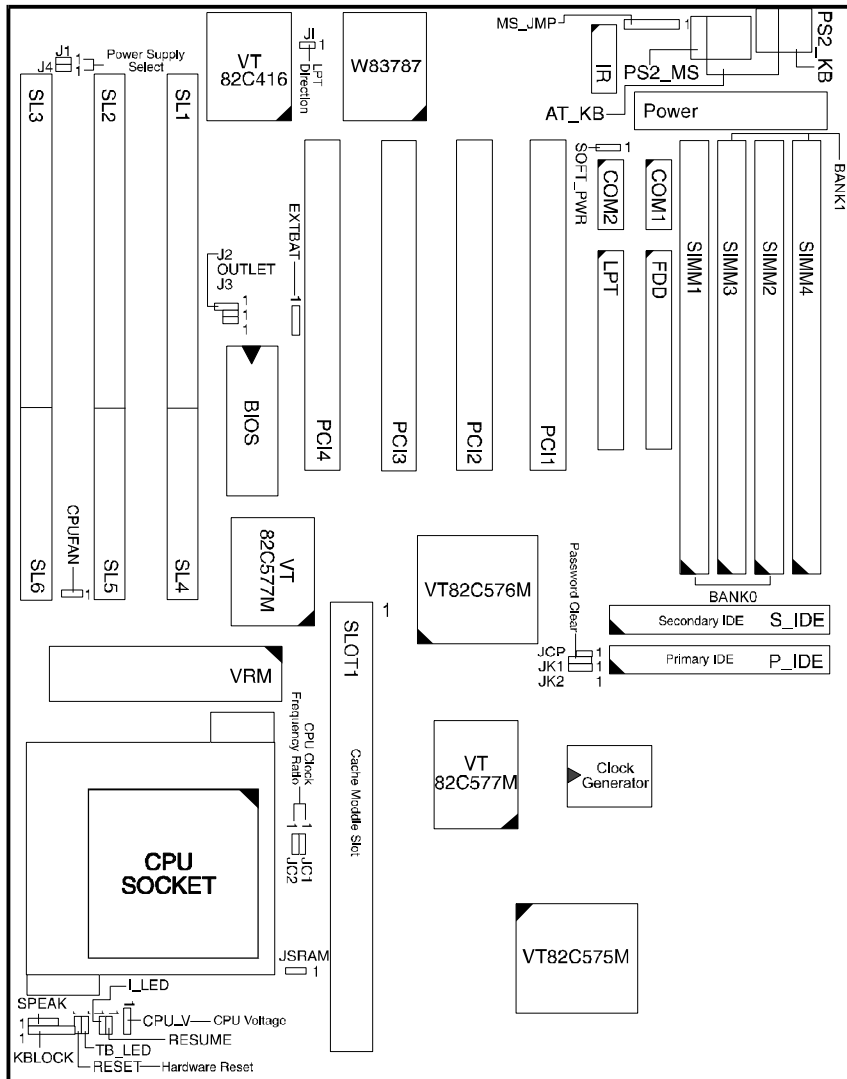

**+ NOTE :** When plugging your processor into the CPU (ZIF) socket, make sure that pin 1 matches that of the CPU socket.



## ***About Your Mainboard***

This section provides useful information that you will need to know should you decide to modify or upgrade the configuration of the mainboard and the system it is installed in. If you do not have the confidence to upgrade the mainboard yourself, we advise that you consult a qualified service technician for assistance.

### ***The BIOS Setup Utility***

The BIOS (Basic Input Output System) is the basic firmware that instructs the computer how to operate. For the BIOS to work properly, there must be a record of the computer's hardware and configuration settings for it to refer to. This record is created using the Setup Utility, a program that is stored permanently in the BIOS ROM chip on the mainboard.

The system configuration record created by the Setup Utility is also stored on the mainboard, but not permanently. This section of the memory it is stored in the NVRAM.

When you buy your computer, the system configuration record will already be set and may in some cases differ from the basic defaults. The first time you use your computer or when you need to re-configure your system, you should run the Setup Utility and write down the settings. Please see Chapter 4 for an explanation on how to run the Setup Utility.

## ***IRQ Functionality***

As you read through this manual, you will see the term “**IRQ**” on a number of occasions. It is important for you to know what this term means, particularly if you intend to upgrade your system.

IRQ stands for “**Interrupt Request**”, the process in which an input or output device tells the processor to temporarily interrupt its current task and immediately process something from the source of the interrupt. When it has completed this, the processor returns to the task it was already processing. Devices that need an IRQ line to operate sometimes need to have exclusive use of that line.

A large number of add-on cards, such as sound cards and LAN cards, require the use of an IRQ line to function. There is a total of 16 IRQs (IRQ0 to IRQ15) available in a system, although some of them may already be in use by components in the system such as the keyboard and mouse. Add-on cards that need to use an IRQ draw from the unused group of IRQs. When installing a card that uses an IRQ, it will have a default IRQ setting which you might have to change if that IRQ is already in use and cannot be shared.

Both ISA and PCI add-on cards may need to use IRQs. System IRQs are available to add-on cards installed on the ISA bus first; the remaining ones can be used by cards installed on the PCI bus. There are two categories of ISA add-on cards: so-called “**Legacy**” ISA cards, which need to be configured manually and then installed in any available ISA slot; and “**Plug and Play**” (PnP) ISA cards, which are configured automatically by the system. As a result, when you install Legacy ISA cards, you have to carefully configure the system to ensure that the installed cards do not conflict with each other by having the same IRQ. With PnP cards, on the other hand, IRQs are assigned automatically from the ones available in the system. In the case of PCI add-on cards, the BIOS automatically assigns an IRQ card to the PCI slot the card is installed in. For further details on this topic, please see Chapter 4 of this manual.

### ***DMA Channels of ISA Cards***

Some Legacy and PnP ISA add-on cards may also need to use a Direct Memory Access (DMA) channel. DMA assignments for this mainboard are handled in the same way as the IRQ assignment process outlined above. For more information, please refer to Chapter 4 of this manual.

### ***Enhanced IDE***

This mainboard features an integrated Enhanced IDE controller that provides convenient, high-speed connections with up to four IDE devices, such as Hard Disk, CD-ROM and Tape Backup Drives. Enhanced IDE is an upgrade of the original IDE specification and provides increased capabilities and performance in a number of areas, including support for Hard Disk Drives of over 528MB and faster data transfer rates utilizing the PIO Mode 4 timing scheme.

With the integrated IDE controller you can connect up to four IDE peripheral devices to your system. All devices are categorized in the same way that IDE Hard Disks were configured in the past, with one device set as the Master device and the other as the Slave device. We recommend that Hard Disk Drives use the primary IDE connector and that CD-ROM drives utilize the secondary IDE connector for improved system performance.

## Mainboard Settings

The PA-2002 has several user-adjustable jumpers on the board that allow you to configure your system to suit your requirements. This chapter contains information on the various jumper settings on your mainboard.

### Jumpers

Jumpers are used to select the operation modes for your system. Some jumpers on the board have three metal pins with each pin representing a different function. To “set” a jumper, a black cap containing metal contacts is placed over the jumper pin/s according to the required configuration. A jumper is said to be “shorted” when the black cap has been placed on one or two of its pins. The types of jumpers used in this manual are shown below:

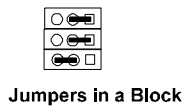
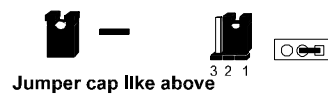
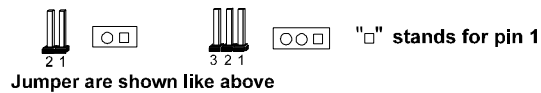

**+ NOTE : Users are not encouraged to change the jumper settings not listed in this manual. Changing the jumper settings improperly may adversely affect system performance.**

### ***CPU Speed Select: JK1, JK2***

The table below shows the jumper settings for the CPU based on its internal clock speed.



CPU Speed	External Clock	JK1	JK2	CPU Clock Rate		
				Int. Multiple	JC1	JC2
200 MHz	66 MHz			3 x Ext.		
166 MHz	66 MHz			2.5 x Ext.		
150 MHz	60 MHz			2.5 x Ext.		
133 MHz	66 MHz			2 x Ext.		
120 MHz	60 MHz			2 x Ext.		
100 MHz	66 MHz			1.5 x Ext.		
90 MHz	60 MHz			1.5 x Ext.		
75 MHz	50 MHz			1.5 x Ext.		

### ***Bus/CPU Clock Ratio: JC1, JC2***

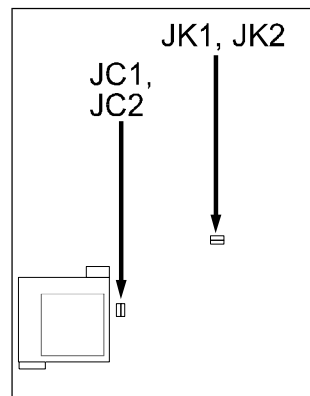

Bus/CPU Clock Ratio	JC1	JC2
1/2		
1/3		
2/3		
2/5		

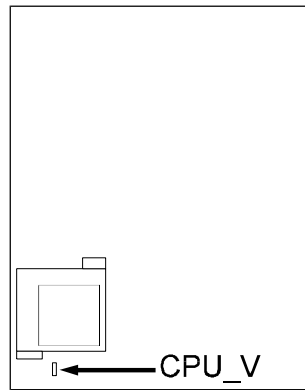

***CPU Voltage Mode Select: CPU\_V***

CPU Voltage Select	CPU_V
STD, VR 3.384V (Default)	
VRE 3.54V	

***Password Clear: JCP***

Password Clear	JCP
Enabled	
Disabled (Default)	

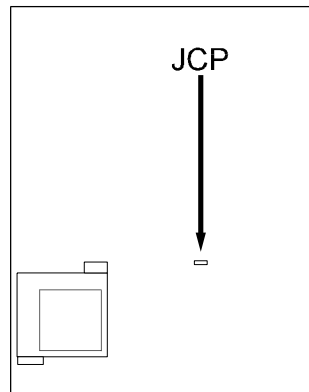

***Power Supply Select: J1, J4***

Power Supply Select	J1	J4
Software Power Supply	<input type="checkbox"/> <input type="checkbox"/>	<input type="checkbox"/> <input type="checkbox"/>
Normal Power Supply (Default)	<input checked="" type="checkbox"/> <input type="checkbox"/>	<input checked="" type="checkbox"/> <input type="checkbox"/>

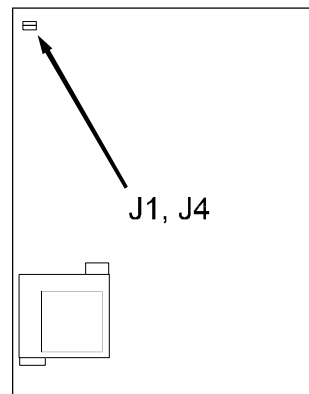
***Flash EPROM Type: J2***

Programmable Flash EPROM Type	J2
Intel 28F001BX-T	<input checked="" type="checkbox"/> <input type="checkbox"/>
SST 29EE010	<input type="checkbox"/> <input checked="" type="checkbox"/>

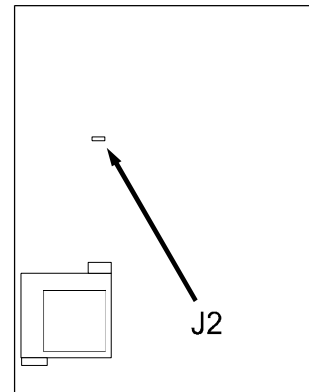

***TB\_LED Mode Select: J3***

TB_LED Mode Select	J3
Turbo LED (Default)	<input type="radio"/> <input type="checkbox"/>
Green Power LED	<input checked="" type="checkbox"/>

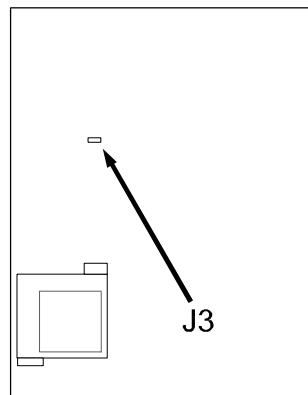
***LPT Direction: J1***

LPT Direction	J1
Output (Default)	<input type="radio"/> <input type="checkbox"/>
Bidirection	<input checked="" type="checkbox"/>

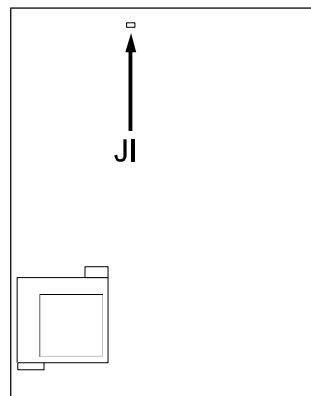



***SRAM Mode Select: JSRAM***

SRAM Mode Select	JSRAM
Asynchronous SRAM (Default)	<input type="radio"/> <input checked="" type="checkbox"/>
Synchronous SRAM	<input checked="" type="checkbox"/> <input type="radio"/>

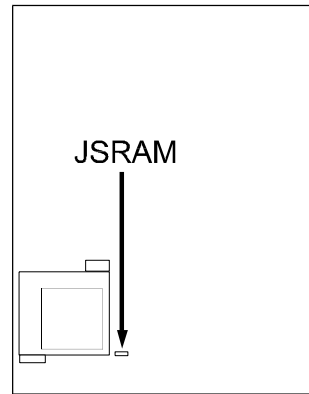
***Hardware Reset: RESET***

Hardware Reset	RESET
Enabled	<input checked="" type="checkbox"/>
Disabled (Default)	<input type="checkbox"/> <input checked="" type="radio"/>

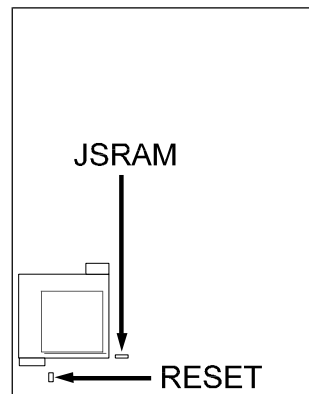

**+ WARNING : Before you install a Cyrix/IBM, the CPU's cooler model must be approved by Cyrix/IBM. Otherwise, your system may overheat. Please refer to your Cyrix/IBM CPU dealer for details.**

## **System Memory**

The PA-2002 can be equipped with sufficient memory for running even the most advanced software applications. Memory comes in the form of DRAM (SIMMs) and cache SRAM. This chapter describes these two types of memory and gives instructions on how to install each type on the mainboard.

### **Memory Locations**

The board layout below shows the locations of the DRAM memory banks and the cache SRAM:

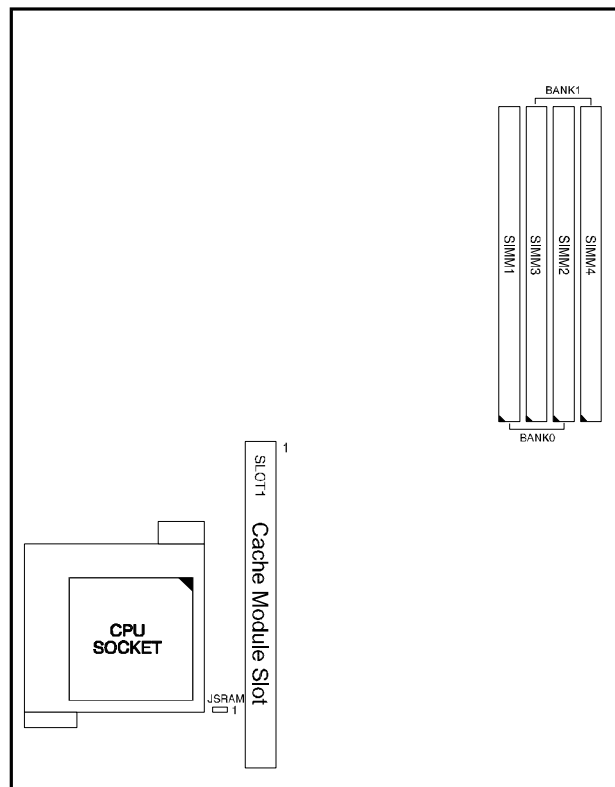

## ***Installing DRAM***

### ***SIMM Banks***

The PA-2002 can accommodate onboard memory from 2 to 128MB using SIMMs (Single-In-Line Memory Modules) which support both BEDO Page Mode DRAM and the advanced EDO DRAM. The mainboard has two memory banks Bank 0 and Bank 1. Each bank has two SIMM sockets which can accept either a 1MB, 4MB, 8MB, 16MB or 32MB SIMM in each socket.

### ***DRAM Configuration***

Memory can be installed in a variety of configurations, as shown in the following table:

<b>TOTAL MEMORY</b>	<b>BANK 0 (72-PIN x 2)</b>	<b>BANK 1 (72-PIN x 2)</b>
2MB	1MB & 1MB	
4MB	1MB & 1MB	1MB & 1MB
8MB	4MB & 4MB	
10MB	4MB & 4MB	1MB & 1MB
16MB	4MB & 4MB	4MB & 4MB
18MB	8MB & 8MB	1MB & 1MB
32MB	16MB & 16MB	
34MB	16MB & 16MB	1MB & 1MB
40MB	16MB & 16MB	4MB & 4MB
48MB	16MB & 16MB	8MB & 8MB
64MB	16MB & 16MB	16MB & 16MB
66MB	32MB & 32MB	1MB & 1MB
72MB	32MB & 32MB	4MB & 4MB
96MB	32MB & 32MB	16MB & 16MB
128MB	32MB & 32MB	32MB & 32MB

**+ NOTE: All memory banks use the 72-pin memory modules.**

### *Installation Instructions*

**† NOTE : Always observe static electricity precautions. See Handling Precautions at the start of this manual.**

1. Locate the SIMM banks on the mainboard.

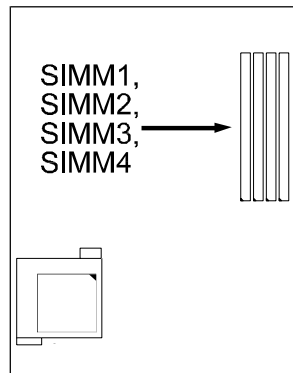

2. Insert the SIMM edge connector at a 90-degree angle onto the socket.

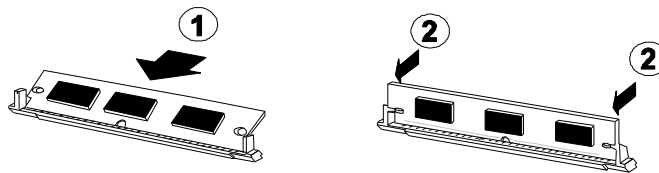

3. Carefully push the SIMM down and back into the socket until the retaining clips of the socket snap, holding the SIMM in place. The holes in the SIMM should match the pins on the socket's retaining clips.

To remove the SIMM/s, pull the retaining latch on both ends of the socket and reverse the procedure above.

## ***Cache Memory***

The PA-2002 accepts 256KB/512KB/1MB standard 3.3V/mix voltage asynchronous SRAM, or 256KB/512KB standard 3.3V synchronous SRAM direct-mapped write-back cache memory with cache module.

### ***Asynchronous SRAM Module***

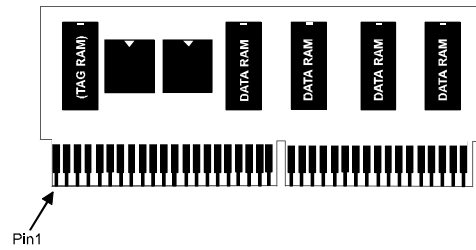

### ***Synchronous SRAM Module***

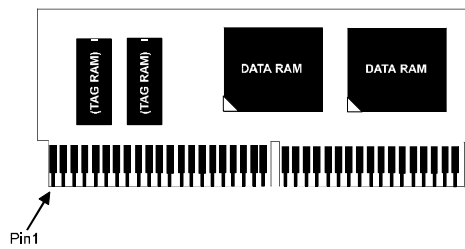

### *Installing Cache Memory*

Locate the cache module slot on the mainboard and insert your cache RAM module carefully.

**† NOTE :** Always observe static electricity precautions. See Handling Precautions at the start of this manual.

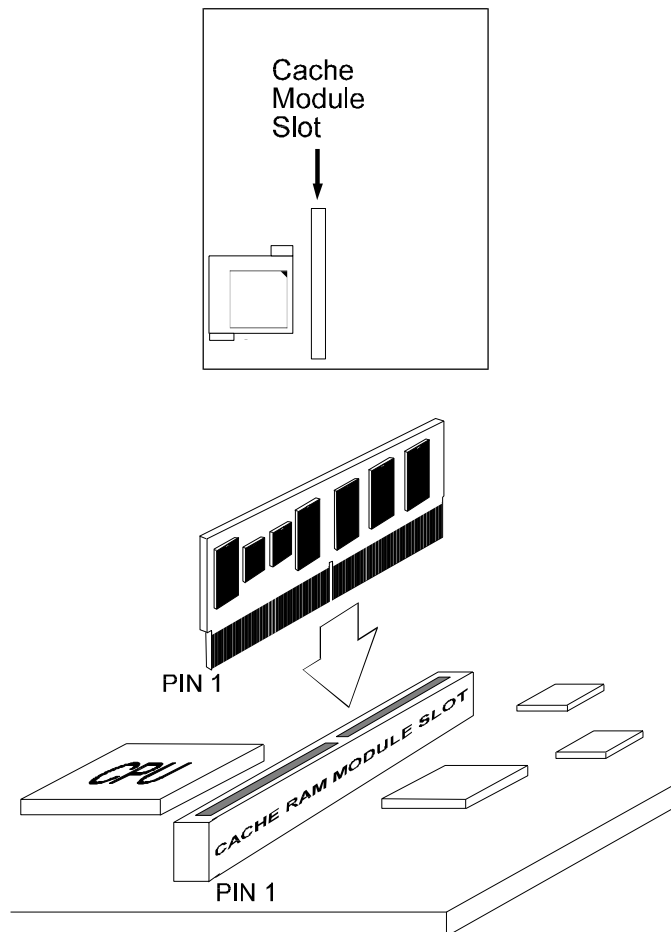

**— THIS PAGE INTENTIONALLY LEFT BLANK —**