

Important Information

Copyright

This publication, including all photographs, illustrations and software, is protected under international copyright laws, with all rights reserved. Neither this manual, nor any of the material contained herein, may be reproduced without the express written consent of the manufacturer.

Version 1.0

Disclaimer

The information in this document is subject to change without notice. The manufacturer makes no representations or warranties with respect to the contents hereof and specifically disclaims any implied warranties of merchantability or fitness for any particular purpose. Further, the manufacturer reserves the right to revise this publication and to make changes from time to time in the content hereof without obligation of the manufacturer to notify any person of such revision or changes.

Trademark Recognition

Microsoft, MS-DOS and Windows are registered trademarks of Microsoft Corp.

MMX, Pentium, Pentium-II, Pentium-III, Celeron are registered trademarks of Intel Corporation.

Other product names used in this manual are the properties of their respective owners and are acknowledged.

Federal Communications Commission (FCC)

This equipment has been tested and found to comply with the limits for a Class B digital device, pursuant to Part 15 of the FCC Rules. These limits are designed to provide reasonable protection against harmful interference in a residential installation. This equipment generates, uses, and can radiate radio frequency energy and, if not installed and used in accordance with the instructions, may cause harmful interference to radio communications. However, there is no guarantee that interference will not occur in a particular installation. If this equipment does cause harmful interference to radio or television reception, which can be determined by turning the equipment off and on, the user is encouraged to try to correct the interference by one or more of the following measures:

- Reorient or relocate the receiving antenna.
- Increase the separation between the equipment and the receiver.
- Connect the equipment onto an outlet on a circuit different from that to which the receiver is connected.
- Consult the dealer or an experienced radio/TV technician for help.

Shielded interconnect cables and a shielded AC power cable must be employed with this equipment to ensure compliance with the pertinent RF emission limits governing this device. Changes or modifications not expressly approved by the system's manufacturer could void the user's authority to operate the equipment.

Declaration of Conformity

This device complies with part 15 of the FCC rules. Operation is subject to the following conditions:

- This device may not cause harmful interference, and
- This device must accept any interference received, including interference that may cause undesired operation.

Canadian Department of Communications

This class B digital apparatus meets all requirements of the Canadian Interference-causing Equipment Regulations.

Cet appareil numérique de la classe B respecte toutes les exigences du Règlement sur le matériel brouilleur du Canada.

About the Manual

The manual consists of the following chapters:

Introduction

Use the **Introduction** Chapter to learn about the features of the mainboard, and verify the checklist of items that are shipped with the package.

Installation

Use the **Installation** Chapter to learn how to install the mainboard and get your system up and running.

Setup

Use the **Setup** Chapter to configure the mainboard for optimum performance.

Software

Use the **Software** Chapter to learn how to install the software drivers and support programs that are provided with this mainboard.

Contents

Important Information	i
<i>Copyright</i>	<i>i</i>
<i>Disclaimer</i>	<i>i</i>
<i>Trademark Recognition</i>	<i>ii</i>
<i>Federal Communications Commission (FCC)</i>	<i>ii</i>
<i>Declaration of Conformity</i>	<i>iii</i>
<i>Canadian Department of Communications</i>	<i>iii</i>
About the Manual	iv
CHAPTER 1: INTRODUCTION	1
Welcome	1
Checklist	2
Recommendations	3
Features	4
CHAPTER 2: INSTALLATION	7
Quick Installation Table	7
Quick Jumper Setting Reference	8
Before You Begin	12
<i>Static Electricity</i>	<i>12</i>
<i>Choosing a Case</i>	<i>12</i>
<i>How to Set Jumpers</i>	<i>13</i>
Preparing the Mainboard	14
<i>Mainboard Guide</i>	<i>14</i>
<i>Mainboard Jumper Guide</i>	<i>16</i>
<i>I/O Ports Side View</i>	<i>18</i>
<i>Check the Jumper Settings</i>	<i>19</i>
<i>Installing the Mainboard in a Case</i>	<i>24</i>
<i>Connecting Internal Components</i>	<i>25</i>
Installing Other Hardware	27
<i>Installing the Processor</i>	<i>27</i>
<i>Install the Memory Modules</i>	<i>29</i>
<i>Installing a Hard Disk Drive and CD-ROM</i>	<i>31</i>
<i>Installing a Floppy Diskette Drive</i>	<i>34</i>

<i>Using the Expansion Slots</i>	35
<i>Add-in Card Options</i>	38
<i>Making External Connections</i>	40
<i>External Connector Color Coding</i>	41
CHAPTER 3: SETUP	43
About the Setup Utility	43
<i>Entering the Setup Utility</i>	44
<i>BIOS Navigation Keys</i>	45
<i>Using BIOS</i>	46
<i>How to Flash a New BIOS</i>	47
<i>Standard CMOS Setup Option</i>	48
<i>Advanced CMOS Setup Option</i>	51
<i>Advanced Chipset Features Option</i>	55
<i>Integrated Peripherals Option</i>	59
<i>Power Management Setup Option</i>	63
<i>PNP/PCI Configuration Option</i>	69
<i>PCI Health Status Option</i>	71
<i>Frequency Control Option</i>	72
<i>Load Fail-Safe Defaults Option</i>	73
<i>Load Optimized Defaults Option</i>	73
<i>Set Supervisor and User Passwords Options</i>	74
<i>Save & Exit Setup Option</i>	75
<i>Exit Without Saving Option</i>	75
CHAPTER 4: SOFTWARE	77
Folders for this Mainboard	78
Auto-installing under Windows 98	79
Utility Folder Installation Notes	83
Realtek-codec Folder Installation Notes	84
Peripheral Folder Installation Notes	85
Mainboard (P6VMM) Installation Notes	85
APPENDIX: JUMPER SETTING REFERENCE	86
Quick Jumper Setting Reference	86

Chapter 1: Introduction

Welcome

Congratulations on purchasing the P6VMM mainboard. The P6VMM mainboard is a Micro ATX mainboard that uses a 4-layer printed circuit board and measures 244 mm x 220 mm. The mainboard features a Socket 370 that accommodates PPGA/FC-PGA Celeron, FC-PGA Pentium III, and Cyrix III processors that support frontside bus (FSB) speeds up to 133 MHz.

The P6VMM uses the VIA family chipset and features the AC 97 audio codec and the embedded Realtek 8139C LAN chip for fast 10/100 Mbps Ethernet connections. The VT8605 chipset also provides an internal AGP function as well as supporting the external AGP interface. The mainboard delivers high-level performance with a 4xAGP (Accelerated Graphics Port) slot and two PCI Bus Master Ultra DMA (UDMA) ports that support up to four ATAPI (AT Attachment Packet Interface) devices. The PCI IDE also supports PIO Mode 3 and 4, UDMA33/66 IDE, and an ATAPI CD-ROM.

The mainboard accommodates PC 100/133 SDRAM (Synchronous DRAM) up to 1 GB using two 3.3V unbuffered DIMM modules. The P6VMM also has a full set of I/O ports, such as dual channel IDE interfaces, a floppy controller, two FIFO serial port connectors, an EPP/ECP-capable bi-directional parallel port connector, a dual USB (Universal Serial Bus) connector, and PS/2 keyboard and mouse connectors.

One AGP slot, two PCI local bus slots, one audio modem riser (AMR) slot, and one optional TV-Out/LCD panel link riser slot provide expandability for add-on peripheral cards.

This chapter contains the following information:

- Checklist** comprises a list of the standard and optional components that are shipped with this mainboard
- Recommendations** lists some Do's and Don'ts from the manufacturer to help ensure reliability and performance from this product
- Features** highlights the functions and components that make this one of the best value mainboards on the market

Checklist

Compare the contents of your mainboard package with the standard checklist below. If any item is missing or appears damaged, please contact the vendor of your mainboard package.

Standard Items

- One P6VMM mainboard
- One diskette drive ribbon cable and bracket
- One IDE drive ribbon cable and bracket
- This user's manual
- Software support CD-ROM disc

Recommendations

This mainboard automatically determines the CPU clock frequency and system bus frequency for the kind of processor that you install. You may be able to change these automatic settings by making changes to jumpers on the mainboard, or changing the settings in the system Setup Utility. We strongly recommend that you do not overclock the mainboard to run processors or other components faster than their rated speed.

Warning: *Overclocking components can adversely affect the reliability of the system and introduce errors into your system. Overclocking can permanently damage the mainboard by generating excess heat in components that are run beyond the rated limits.*

Components on this mainboard can be damaged by discharges of static electricity. Handle the board carefully holding it by the edges. Don't flex or stress the circuit board. Keep the board in its static-proof packing until you are ready to install it. Follow the static guidelines given at the beginning of Chapter 2.

Features

The key features of this mainboard are the wide range of processors that can be installed, and the high level of integration.

Value-class Processors

Functioning as a platform for a value PC, the P6VMM features a Socket 370 that accommodates PPGA/FC-PGA Celeron, FC-PGA Pentium III, and Cyrix III processors. The P6VMM supports 66/100/133 MHz FSB speeds.

VIA Chipset

This board features the VIA VT8605 chipset, enabling synchronous and asynchronous frequency operation between the processor and the memory over a wide frequency range.

Inexpensive Memory

The board has two DIMM sockets for the installation of 168-pin, 3.3V non-buffered DIMM memory modules. The DIMM memory modules must be SDRAM memory chips.

Integrated Realtek Fast Ethernet

The RTL8139C LAN chip is an integrated chip and transceiver capable of operating at 10/100 Mbps. This PCI Revision 2.2-compliant chip supports PCI target fast back-to-back transaction, Vital Product Data (VPD), and ACPI/PCI power management.

4xAGP Graphics Adapter Slot

In addition to the onboard Accelerated Graphics Port (AGP) capability provided by the VT8605 chipset, P6VMM includes a 4xAGP slot that provides four times the bandwidth of the original AGP specification. AGP technology provides a direct connection between the graphics sub-system and the processor so that the graphics do not have to compete for processor time with other devices on the PCI bus.

The AGP design allows the graphics controller to use part of the main memory when it needs it, for example, in handling the very large texture maps required by virtual reality and 3D video games and applications.

AC 97 Audio Codec

The AC 97 Audio codec is compliant with the AC 97 2.1 specification, and supports 18-bit ADC (Analog Digital Converter) and DAC (Digital Analog Converter) resolution as well as 18-bit stereo full-duplex codec with independent and variable sampling rates. Further features include support for four analog line-level stereo inputs.

Expansion Options

Two 32-bit PCI slots, an AGP slot, an AMR slot, and an optional TV-out/LCD panel link riser slot provide plenty of expansion potential. The P6VMM PCI slots support Ultra DMA33/66 bus mastering with transfer rates up to 33/66 MB/sec.

Integrated I/O

The mainboard has a full set of I/O ports and connectors. The I/O template on the backplane includes two PS/2 ports for mouse and keyboard, one serial port, one VGA port, one parallel port, one MIDI/game port, two USB ports, and audio jacks for microphone, line-in and line-out. The board includes two PCI IDE channels and a floppy disk drive interface.

Keyboard Power on Feature

Using the system BIOS setup program, you can configure the system to turn on using a keyboard-typed password. A green keyboard is not required.

Programmable Firmware

The mainboard includes Award BIOS that allows BIOS setting of CPU parameters. This fully programmable firmware enhances the system features and allows users to set such items as power management, CPU and memory timing, and modem wake-up alarms. The firmware can also be used to set parameters for different processor clock speeds so that you don't need to change mainboard jumpers and switches.

This concludes Chapter 1. The next chapter will cover installing and building a working system.

Chapter 2: Installation

Quick Installation Table

This chapter explains how to successfully install the mainboard into a computer case and build a working system. The installation procedure is as follows:

Quick Jumper Setting Reference	Provides a quick reference for the jumper settings on this mainboard.
Before you Begin	Provides advice on choosing a case, avoiding static electricity damage, and setting jumpers.
Preparing the Mainboard	Provides a guide to the mainboard and I/O port locations, full details on the jumper settings, and advice on installing the mainboard in the system case.
Install Other Hardware	Provides guidance on installing essential hardware: processor, memory, hard disk drive, CD-ROM, floppy disk drive, and expansion cards.
Make the External Connections	Provides advice on using the external I/O ports to install peripheral devices such as a keyboard, a monitor, a mouse, a printer, and loudspeakers.

Quick Jumper Setting Reference

If you are familiar with most of the material in this chapter, you can prepare the mainboard for installation by using this quick reference to set the jumpers. A detailed description of the jumper setting appears later in this chapter.

JP1: Clear CMOS jumper

Use this jumper to clear the contents of the CMOS memory.

Function	Jumper Setting
Normal operation	Short pins 1-2
Clear CMOS	Short pins 2-3



JP2: Keyboard Power On/Off jumper

Use this jumper to enable the keyboard to power on the computer. You must also enable this function in the BIOS Setup Utility. Refer to Chapter 3.

Function	Jumper Setting
Disable	Short pins 1-2
Enable	Short pins 2-3

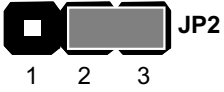

JP5: Suspend to RAM support enable/disable jumper

Use this jumper to enable or disable the Suspend to RAM (STR) Function. You must also enable this function in the BIOS Setup Utility. Refer to Chapter 3.

Function	Jumper Setting
Enable	Short pins 1-2
Disable	Short pins 2-3



JP6: USB wake up jumper

Use this jumper to enable a signal to the USB ports (located on the I/O port panel) to wake up the system from power saving mode.

Function	Jumper Setting
Disable	Short pins 1-2
Enable	Short pins 2-3



JP7: CPU frequency select jumper

Use this jumper to force a CPU that has a 66 MHz frontside bus (FSB) to run at a 100 MHz FSB speed.

Function	Jumper Setting
Normal operation	Short pins 1-2
Force a 66 MHz FSB to run at 100 MHz FSB	Short pins 2-3



Note: The CPU speed is determined by the CPU Host/PCI Clock speed multiplied by the CPU Clock Ratio. Refer to the Frequency Control Option in Chapter 3 for more information.

Forcing the CPU to run at a higher clock speed than it was rated for is called overclocking and is not recommended.

JP8: CPU frequency select jumper

Use this jumper to force a CPU that has a 100 MHz frontside bus (FSB) to run at a 133 MHz FSB speed.

Function	Jumper Setting
Normal operation	Short pins 1-2
Force a 100 MHz FSB to run at 133 MHz FSB	Short pins 2-3



Note: The CPU speed is determined by the CPU Host/PCI Clock speed multiplied by the CPU Clock Ratio. Refer to the Frequency Control Option in Chapter 3 for more information.

Forcing the CPU to run at a higher clock speed than it was rated for is called overclocking and is not recommended.

JP11, JP12, JP13: Flat Panel/TV select jumpers

Use these jumpers to select a flat panel or TV display when using the LT11 riser.

Function	Jumper Setting
Flat Panel	Short JP11/12/13 pins 1-2
TV	Short JP11/12/13 pins 2-3

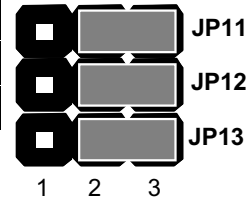

JP14: Onboard CODEC/AMR slot select jumper

Use this jumper to enable either the onboard codec or the AMR slot (AMR1).

Function	Jumper Setting
Onboard codec	Short pins 1-2
AMR slot	Short pins 2-3



JP16: Dual color LED header

This header allows the user to install red and green LED indicators to indicate when the computer is in Suspend to RAM (STR) or normal. Although the values are not predefined, red usually indicates STR and green indicates normal.

JP17: USB2 wake up jumper

Use this jumper to enable a signal to the USB devices 3 and 4 (located on the front panel) to wake up the system from power saving mode.

Function	Jumper Setting
Disable	Short pins 1-2
Enable	Short pins 2-3



JP18: BIOS Flash protect jumper

Use this jumper to enable or disable the BIOS flash protection on the mainboard. You should disable this jumper when you want to flash the BIOS.

Function	Jumper Setting
Disable	Short pins 1-2
Enable	Short pins 2-3



JP19: AMR codec mode

Use this jumper to define the AMR codec mode to avoid conflict with the onboard AC 97 codec.

Function	Jumper Setting
Slave AMR card	Short pins 1-2
Master AMR card	Short pins 2-3



PANEL1: Panel connectors for switches and indicators

Use the panel connector to implement the switches and indicators on your system case.

Panel connectors for switches and indicators

Function	Pins
Speaker	1, 3, 5, 7
Power LED Indicator	+2, 4, 6
Green LED Indicator	+13, 14
Hard Disk LED Indicator	+15, 16
Reset Switch	17, 18
Sleep Switch (SMI) Indicator	+19, 20
Power ON/OFF	21, 22

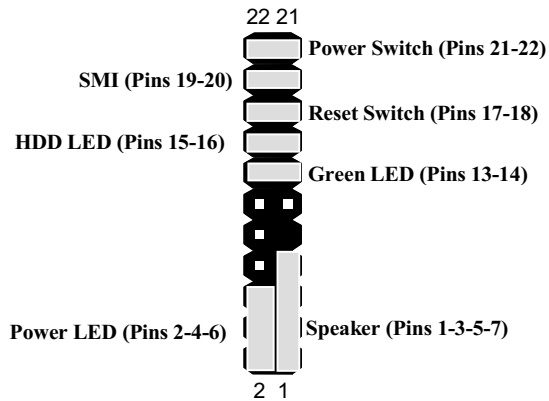

Before You Begin

Before you begin to install your mainboard, take care not to damage the product from static electricity. Ensure too that you are installing the mainboard into a suitable case.

Static Electricity

In adverse conditions, static electricity can accumulate and discharge through the integrated circuits and silicon chips on this product. These circuits and chips are sensitive and can be permanently damaged by static discharge.

- If possible, wear a grounding wrist strap clipped to a safely grounded device during the installation.
- If you don't have a wrist strap, discharge any static by touching the metal case of a safely grounded device before beginning the installation.
- Leave all components inside their static-proof bags until they are required for the installation procedure.
- Handle all circuit boards and electronic components carefully. Hold boards by the edges only. Do not flex or stress circuit boards.

Choosing a Case

The mainboard complies with the specifications for the Micro ATX system case. Some features on the mainboard are implemented by cabling connectors on the mainboard to indicators and switches on the system case. Ensure that your case supports all the features required. The mainboard can support one or two floppy diskette drives and four enhanced IDE drives. Ensure that your case has sufficient power and space for all the drives that you intend to install.

The mainboard has a set of I/O ports on the rear edge. Ensure that your case has an I/O template that supports the I/O ports and expansion slots.

How to Set Jumpers

A jumper consists of two or more pins mounted on the mainboard. Some jumpers might be arranged in a series with each pair of pins numbered differently. Jumpers are used to change the electronic circuits on the mainboard. When a jumper cap (or shunt) is placed on two jumper pins, the pins are **SHORT**. If the jumper cap is removed (or placed on just a single pin), the pins are **OPEN**.

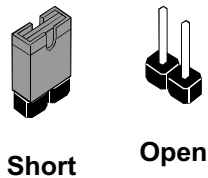

This illustration shows a 2-pin jumper. When the jumper cap is placed on both pins, the jumper is **SHORT**. If you remove the jumper cap, or place the jumper cap on just one pin, the jumper is **OPEN**.

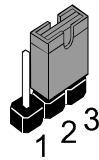

This illustration shows a 3-pin jumper. The jumper cap is placed on pins 2 and 3, so this jumper setting is **SHORT PINS 2-3**.

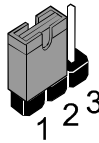

This illustration shows the same 3-pin jumper. The jumper cap is placed on pins 1 and 2, so this jumper setting is **SHORT PINS 1-2**.

In this manual, all the jumper illustrations clearly show the pin numbers. When you are setting the jumpers, make sure that the jumper caps are placed on the correct pins to select the function or feature that you want to enable or disable.

Preparing the Mainboard

Mainboard Guide

Use the following illustration and key to identify the components on your mainboard.

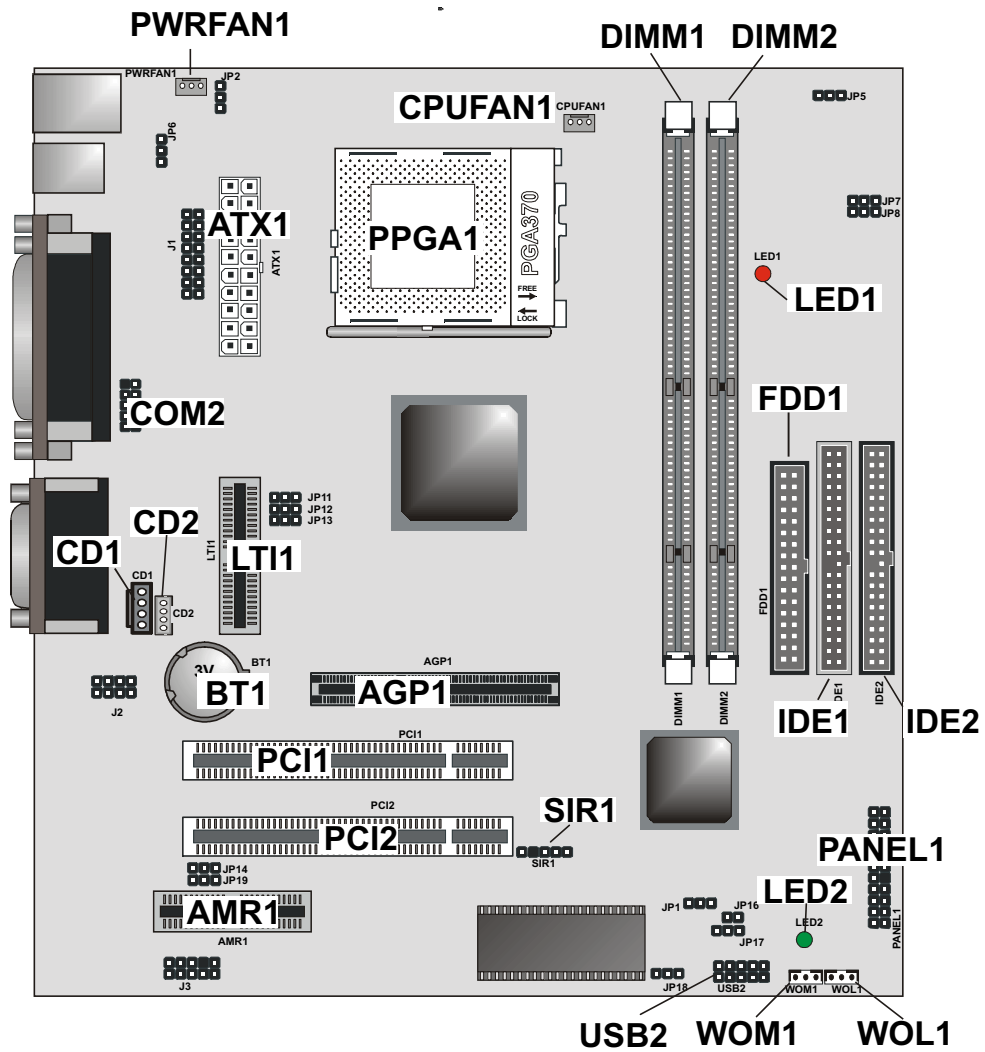

Key to Mainboard Components

Component	Description
PWRFAN1	Power connector for case cooling fan
DIMM 1, 2	Two slots for 168-pin DRAM memory module
CPUFAN1	Power connector for CPU cooling fan
ATX1	Connector for ATX power supply
PPGA1	CPU socket
LED1	3 VSB for SDRAM (red)
FDD1	Connector for floppy disk drives
IDE1, IDE2	Primary and secondary IDE channels
CD1	Audio connector for CD-ROM/DVD drive
CD2	Auxiliary connector for CD-ROM/DVD drive
LTI1	TV-out/LCD panel link riser (optional)
BT1	3 volt battery for realtime clock
J1	Extra IR/KB/Mouse header
J2	Extra MIC/Line-out header
J3	LAN header
COM2	COM port header
AMR1	Audio modem riser (AMR) slot
PCI1, PCI2	Two 32-bit PCI slots
SIR1	SIR connector for infrared
AGP1	Accelerated Graphics Port slot
WOL1	Connector for LAN wake up
WOM1	Connector for modem wake up
LED2	Power LED (green)
PANEL1	Panel connector for switches and indicators
USB2	Connector for USB port

Note: LED1 and LED 2

LED1: This red indicator warns you that the computer is still powered on and you should not install or uninstall memory modules.

LED2: This green indicator warns you that the computer is still active and you should not carry out any work on the mainboard.

Mainboard Jumper Guide

Use the following illustration and key to identify the jumpers on your mainboard.

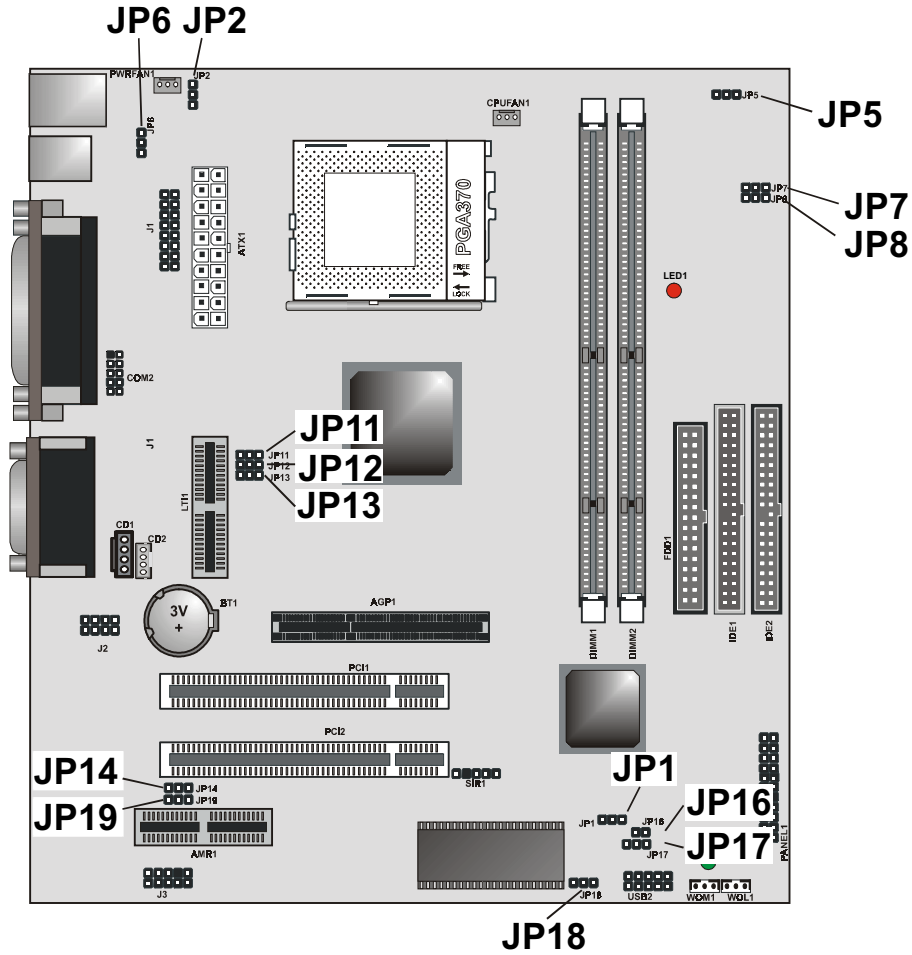

Key to Mainboard Jumper Components

Component	Description
JP1	Clear the system CMOS jumper
JP2	Keyboard power on/off jumper
JP5	Suspend to RAM support jumper
JP6	USB wake up select jumper
JP7, 8,	CPU frequency select jumper
JP11, 12, 13	Flat/TV jumper
JP14	On-board codec or AMR slot select jumper
JP16	Dual color LED header
JP17	USB wake up jumper
JP18	BIOS flash protect jumper
JP19	AMR codec mode jumper

I/O Ports Side View

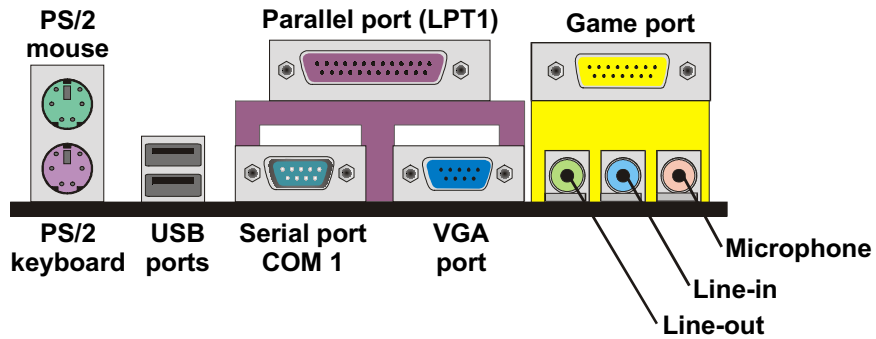

Key to I/O Ports

Component	Description
PS/2 mouse	PS/2 port for pointing device (upper port)
PS/2 keyboard	PS/2 port for keyboard (lower port)
USB ports	Two stacked Universal Serial Bus ports
LPT1	External parallel port
COM1	External serial port COM 1
VGA	External video port
Game port	External MIDI/game port
Audio ports	Audio jacks for (from left to right) line out, line in, microphone

JP1: Clear CMOS jumper

Use this jumper to clear the contents of the CMOS memory. You may need to clear the CMOS memory if the settings in the BIOS Setup Utility are incorrect and are preventing your mainboard from operating. To clear the CMOS memory, disconnect all the power cables from the mainboard and then move the jumper cap into the Clear CMOS memory setting for a few seconds. CMOS is cleared.

Return the jumper cap to the Normal operation setting. Reconnect the power cables and start the system. When the POST starts, press the delete key to start the BIOS Setup Utility and reload BIOS optimal settings. Refer to Chapter 3 for information on BIOS.

Function	Jumper Setting
Normal operation	Short pins 1-2
Clear CMOS	Short pins 2-3



JP2: Keyboard Power On/Off jumper

Use this jumper to enable the keyboard to power on the computer. You must also enable this function in the BIOS Setup Utility. Refer to Chapter 3.

Function	Jumper Setting
Disable	Short pins 1-2
Enable	Short pins 2-3

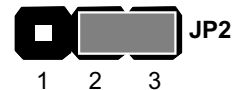

JP5: Suspend to RAM support enable/disable jumper

Use this jumper to enable or disable the Suspend to RAM (STR) Function. You must also enable this function in the BIOS Setup Utility. Refer to Chapter 3.

Function	Jumper Setting
Enable	Short pins 1-2
Disable	Short pins 2-3



JP6: USB wake up jumper

Use this jumper to enable a signal to the USB ports (located on the I/O port panel) to wake up the system from power saving mode.

Function	Jumper Setting
Disable	Short pins 1-2
Enable	Short pins 2-3



JP7: CPU frequency select jumper

This jumper enables you to force the CPU to clock at a higher frequency than it is rated. Short pins 2 and 3 to force the CPU to run at a 100 MHz FSB instead of a 66 MHz FSB. We recommend that you leave the jumper on the normal operation setting.

Function	Jumper Setting
Normal	Short pins 1-2
Force 66 MHz FSB to run at 100 MHz FSB.	Short pins 2-3



JP8: CPU frequency select jumper

This jumper enables you to force the CPU to clock at a higher frequency than it is rated. Short pins 2 and 3 to force the CPU to run at a 133 MHz FSB instead of a 100 MHz FSB. We recommend that you leave the jumper on the normal operation setting.

Function	Jumper Setting
Normal	Short pins 1-2
Force 100 MHz FSB to run at 133 MHz FSB	Short pins 2-3



Note: The CPU speed is determined by the CPU Host/PCI Clock speed multiplied by the CPU Clock Ratio. Refer to the Frequency Control Option in Chapter 3 for more information.

Forcing the CPU to run at a higher clock speed than it was rated for is called *overclocking* and is not recommended.

JP11, JP12, JP13: Flat Panel/TV select jumpers

Use these jumpers to select a flat panel or TV display when using the LT11 riser.

Function	Jumper Setting
Flat Panel	Short JP11/12/13 pins 1-2
TV	Short JP11/12/13 pins 2-3

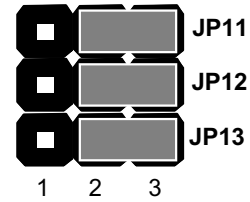

JP14: Onboard CODEC/AMR slot select jumper

Use this jumper to enable either the onboard codec or the AMR slot (AMR1).

Function	Jumper Setting
Onboard codec	Short pins 1-2
AMR slot	Short pins 2-3

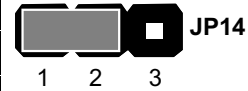

JP16: Dual color LED header

This header allows the user to install red and green LED indicators to indicate when the computer is in Suspend to RAM (STR) or normal. Although the values are not predefined, red usually indicates STR and green indicates normal.

JP17: USB2 wake up jumper

Use this jumper to enable a signal to the USB devices 3 and 4 (located on the front panel) to wake up the system from power saving mode.

Function	Jumper Setting
Disable	Short pins 1-2
Enable	Short pins 2-3



JP18: BIOS Flash protect jumper

Use this jumper to enable or disable the BIOS flash protection on the mainboard. You should disable this jumper when you want to flash the BIOS.

Function	Jumper Setting
Disable	Short pins 1-2
Enable	Short pins 2-3



JP19: AMR codec mode

Use this jumper to define the AMR codec mode to avoid conflict with the onboard AC 97 codec.

Function	Jumper Setting
Slave AMR card	Short pins 1-2
Master AMR card	Short pins 2-3



Installing the Mainboard in a Case

Most system cases have mounting brackets installed in the case, which correspond to the holes in the mainboard. Place the mainboard over the mounting brackets and secure the mainboard into the mounting brackets with screws.

Most cases have a choice of I/O templates in the rear panel. Make sure that the I/O template in the case matches the I/O ports installed on the rear edge of the mainboard.

This illustration shows a mainboard installed in a standard desktop case.

Note: Do not overtighten the screws as this can stress the mainboard.

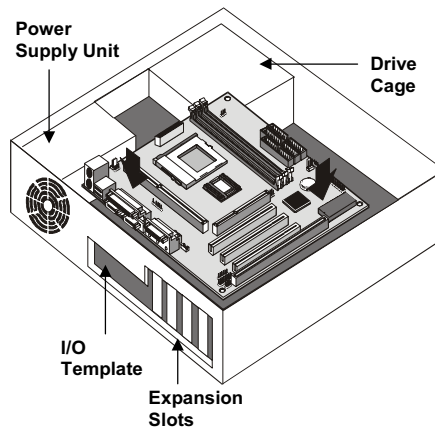

This illustration shows a mainboard installed in a tower-type case.

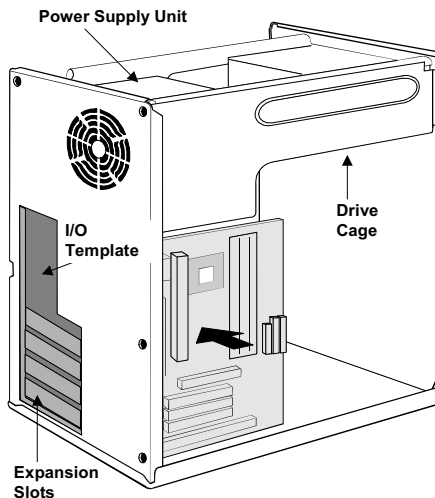

Connecting Internal Components

After you have installed the mainboard into the system case, connect the power cable from the case power supply unit to the mainboard power connector ATX1.

Your case and CPU might have cooling fans attached to provide adequate ventilation to the system. Connect the CPU fan to the 12-volt connector CPUFAN1. Connect the case fan to the 12-volt power supply connector PWRFAN1. After you have connected the power supply and the cooling fans, connect the case switches and indicators to the PANEL1 connectors.

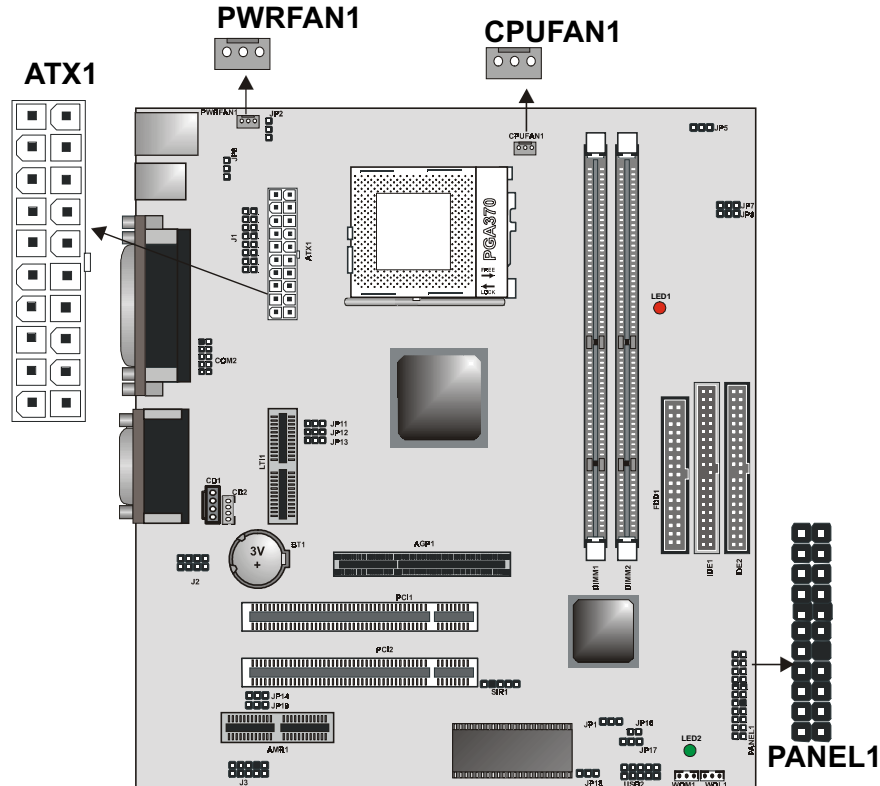

Panel Connector

The mainboard PANEL connector has a standard set of switch and indicator connectors that are commonly found on ATX system cases. Use the illustration below to make the correct connections to the case switches and indicators.

Panel connectors for switches and indicators

Function	Pins
Speaker	1, 3, 5, 7
Power LED Indicator	+2, 4, 6
Green LED Indicator	+13, 14
Hard Disk LED Indicator	+15, 16
Reset Switch	17, 18
Sleep Switch (SMI) Indicator	+19, 20
Power ON/OFF	21, 22

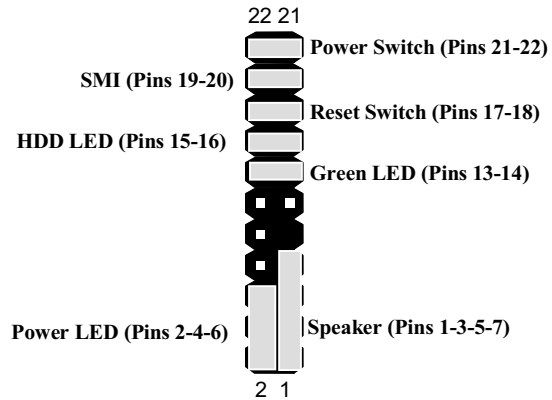

Installing Other Hardware

Start installing the essential hardware required to get your system started.

Installing the Processor

This mainboard has a Socket 370 processor socket. To choose a processor, you need to consider the performance requirements of the system and the price of the processor. Performance is based on the processor design, the clock speed and system bus frequency of the processor, and the quantity of internal cache memory and external cache memory. Higher clock speeds and larger amounts of cache memory deliver greater performance.

Installation Procedure

Follow the steps below to install a processor on your mainboard:

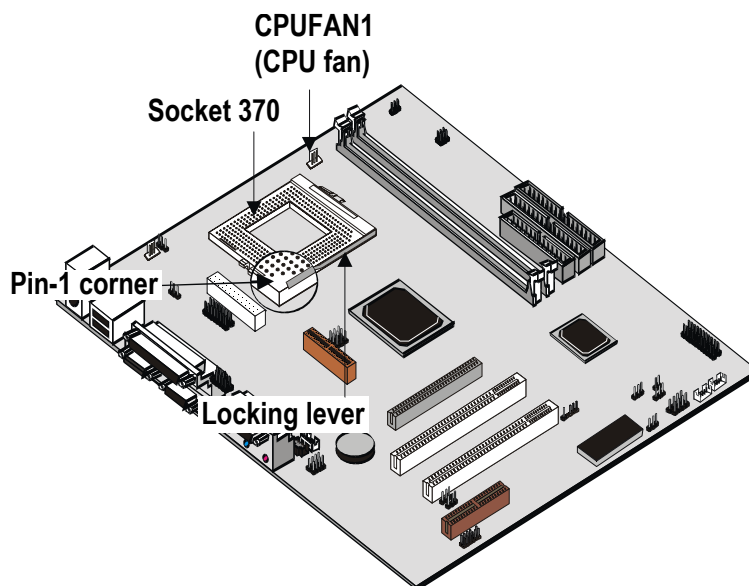

1. On the mainboard, locate the Socket 370 and CPU cooling fan CPUFAN1.

2. On the Socket 370, pull the locking lever away from the socket to unhook it and then raise the locking lever to the upright position.
3. Identify the pin-1 corner on the Socket 370 and the pin-1 corner on the processor. The socket pin-1 corner is adjacent to the handle of the locking lever. The processor pin-1 corner is beveled.
4. Matching the pin-1 corners, drop the processor into the socket. No force is required and the processor should seat into the socket easily.
5. Swing the locking lever down and hook it under the latch on the edge of the socket. This locks the processor in place.
6. Locate the power cable on the heatsink/cooling fan assembly that is attached to the top of the processor.
7. Plug the power cable into the CPU cooling CPUFAN1 12V-power supply on the mainboard.

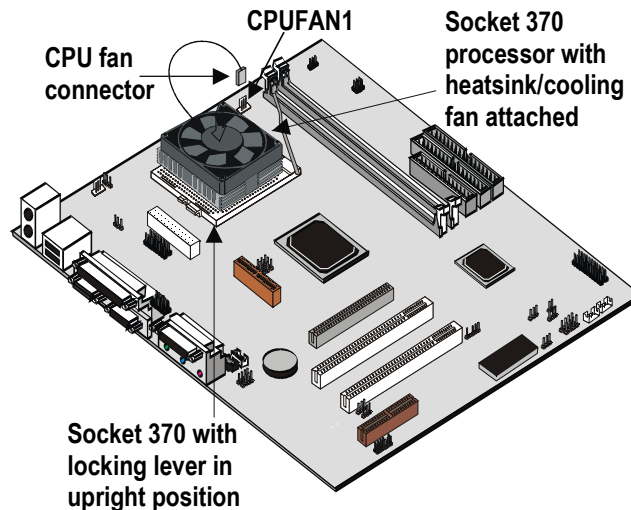

The mainboard must be configured to deliver the correct clock speed and the correct system bus for the kind of processor that you have installed. You can do this by using the system Setup Utility. The first time you start the system, immediately enter the setup system and make the appropriate settings. Usually, you can automatically configure the CPU by using the CPU & BIOS Features page of the Setup Utility. See Chapter 3 for more information.

Install the Memory Modules

For this mainboard, you must use 168-pin 3.3V non-buffered Dual In-line Memory Modules (DIMMs). The memory chips must be standard or registered SDRAM and VCM SDRAM memory chips. The memory bus can run at 100 MHz or 133 MHz. If your processor operates over a 133 MHz system bus, you can install PC133 or PC100 memory modules. If your processor operates over a 100 MHz system bus, you can install memory that runs at 133 MHz or 100 MHz bus. If your processor operates over a 66 MHz, you can only install memory chips that operate at 100MHz.

Supported Memory Configurations

The following table shows the memory configurations supported:

Technology	Configuration	# of Row Addrs Bits	# of Col Addrs Bits	# of Bank Addrs Bits	Page Size
64 Mbit	8M x 8	12	8	2	4 KB
64 Mbit	4M x 16	12	9	2	2 KB
128 Mbit	32M x 4	12	11	2	16 KB
128 Mbit	16M x 8	12	10	2	8 KB

Note: 32M x 4 128 Mbit is for registered DIMMs only, 4M x 16 64 Mbit support is for unbuffered DIMMs only.

The following table shows the maximum memory for DIMM based platforms:

DRAM Configuration		1 DIMM		2 DIMMs	
		SS	DS	SS	DS
64 Mbit	8M x 8	64 MB	128 MB	128 MB	256 MB
64 Mbit	4M x 16	32 MB	64 MB	64 MB	128 MB
128 Mbit	16M x 8	128 MB	256 MB	256 MB	512 MB
128 Mbit	32M x 4	256 MB	512 MB	512 MB	1024 MB

Note: Single-sided DIMM use one SDRAM row. (SS = Single Sides)
Double-sided DIMM use two SDRAM rows. (DS = Double Sides)

Installation Procedure

There are two slots for memory modules. You must install at least one module, and it makes no difference which slot you use to install the module. Each module can be populated with from 32 MB to 512 MB of memory; total memory capacity is 1 GB.

1. Locate the DIMM slots on the mainboard.

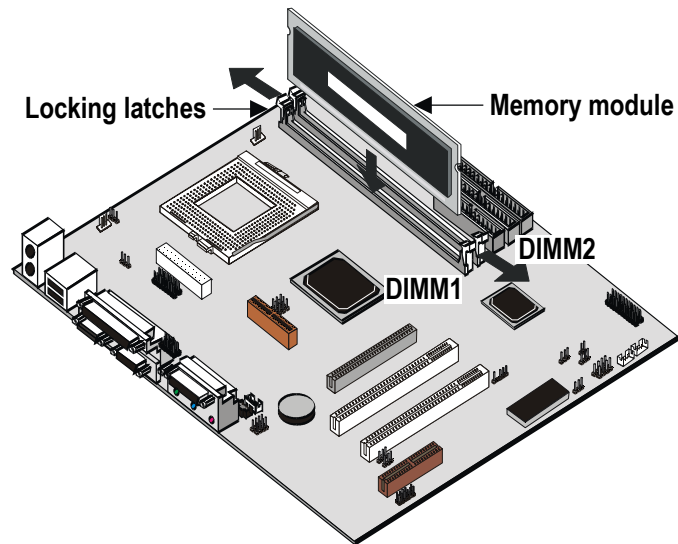

2. The DIMM slots are keyed with notches and the DIMMs are keyed with cutouts so that they can only be installed correctly. Check that the cutouts on the DIMM module edge connector match the notches in the DIMM slot.
3. Push the latches on each side of the DIMM slot down.
4. Install the DIMM module into the slot and press it firmly down so that it seats correctly. The latches at either side of the slot will be levered upwards and latch on to the edges of the DIMM when it is installed correctly.

Installing a Hard Disk Drive and CD-ROM

This section describes how to install IDE devices such as a hard disk drive and a CD-ROM drive.

Note: *Ribbon cable connectors are usually keyed so that they can only be installed correctly on the device connector. If the connector is not keyed, make sure that you match the pin-1 side of the cable connector with the pin-1 side of the device connector. Each connector has the pin-1 side clearly marked. The pin-1 side of each ribbon cable is always marked with a colored stripe on the cable.*

About IDE Devices

Your mainboard has a primary IDE channel interface (IDE1) and a secondary IDE interface (IDE2). The mainboard ships with one IDE ribbon cable that supports one or two IDE devices. All IDE devices have jumpers or switches that can be used to set the IDE device as MASTER or SLAVE.

If you install two IDE devices on one cable, you must make sure that one device is set to MASTER and the other device is set to SLAVE. The documentation of your IDE device explains how to do this.

If you want to install more than two IDE devices, obtain a second IDE cable and you can add two more devices to the secondary IDE channel. If there are two devices on the cable, make one MASTER and one SLAVE.

About UDMA

This board supports UltraDMA 33/66. UDMA is a technology that speeds the performance of devices in the IDE channel. We recommend that you install IDE devices that support UDMA, and use IDE cables that support UDMA.

Installing a Hard Disk Drive

1. Install the hard disk drive into the drive cage in your system case.
2. Plug the IDE cable into the primary IDE channel on the mainboard IDE1.
3. Plug one of the connectors on the IDE cable into the IDE connector on the back edge of the hard disk drive. It doesn't matter which connector on the cable that you use. Make sure that you have the pin-1 side of the cable matched with the pin-1 side of the connector.
4. Plug a power cable from the case power supply unit into the power connector on the back edge of the hard disk drive.
5. When you first start up your system, go immediately to the Setup Utility and use the IDE Hard Disk Auto Detect feature to configure the IDE devices that you have installed. See Chapter 3 for more information.

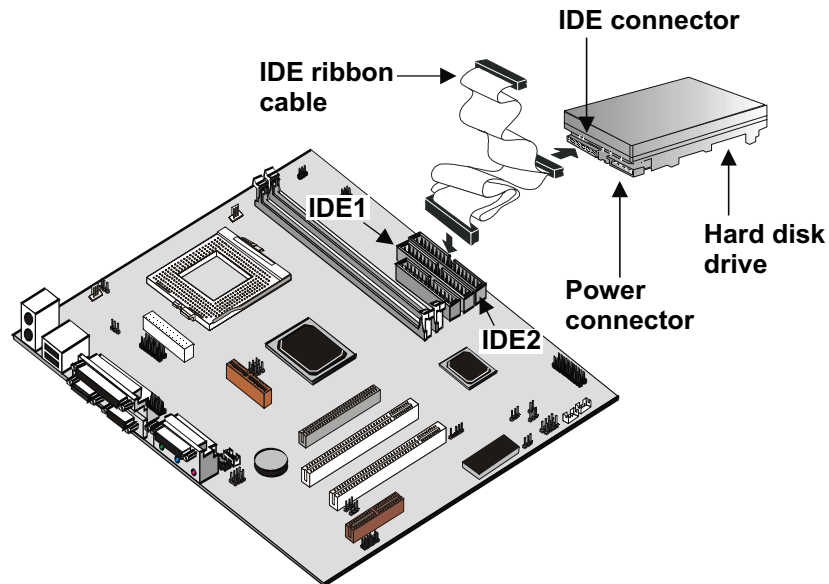

Installing a CD-ROM/DVD Drive

1. Install the CD-ROM/DVD drive into the drive cage in your system case. Plug the IDE cable into the primary IDE channel on the mainboard IDE1.
2. Plug one of the connectors on the IDE cable into the IDE connector on the back edge of the CD-ROM/DVD drive. It doesn't matter which connector on the cable that you use. Make sure that you have the pin-1 side of the cable matched with the pin-1 side of the connector.
3. Plug a power cable from the case power supply unit into the power connector on the back edge of the CD-ROM/DVD drive.
4. Use the audio cable provided with the CD-ROM/DVD drive to connect the audio connector on the rear edge of the CD-ROM/DVD drive to the one of the two audio-in connectors CDIN1 and CDIN2 on the mainboard.
5. When you first start up your system, go immediately to the Setup Utility and use the IDE Hard Disk Auto Detect feature to configure the IDE devices that you have installed. See Chapter 3 for more information.

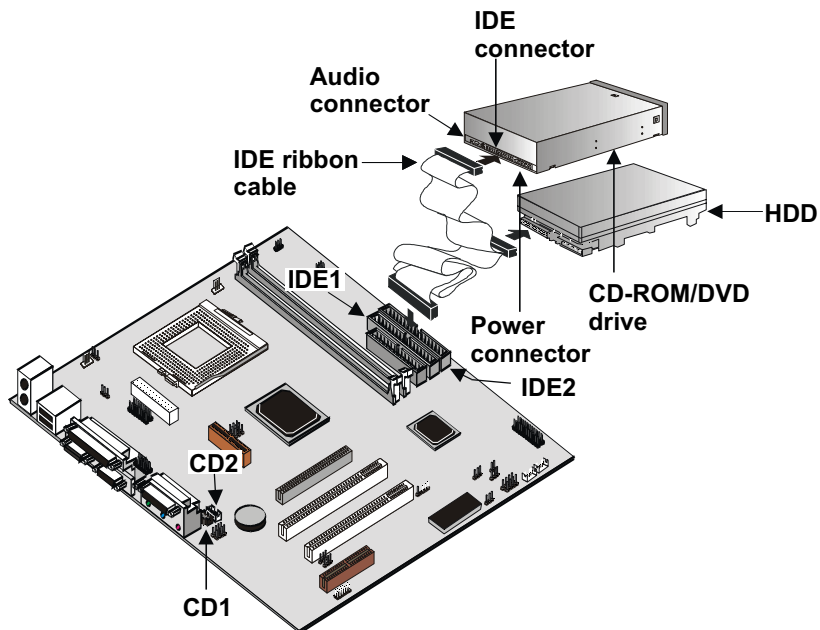

Installing a Floppy Diskette Drive

The mainboard has a floppy diskette drive interface and it ships with a diskette drive ribbon cable that supports one or two floppy diskette drives. You can install a 5.25-inch drive and a 3.5-inch drive with various capacities. The floppy diskette drive cable has one type of connector for a 5.25-inch drive and another type of connector for a 5.25-inch drive

1. Install the floppy diskette drive into the drive cage in your system case. Plug the diskette drive cable into the diskette drive interface on the mainboard FDD1.
2. Plug one of the connectors on the diskette drive cable into the data connector on the back edge of the floppy diskette drive. Make sure that you have the pin-1 side of the cable matched with the pin-1 side of the connector.
3. Plug a power cable from the case power supply unit into the power connector on the back edge of the diskette drive.
4. When you first start up your system, go immediately to the Setup Utility and use the Standard page to configure the floppy diskette drives that you have installed. See Chapter 3 for more information.

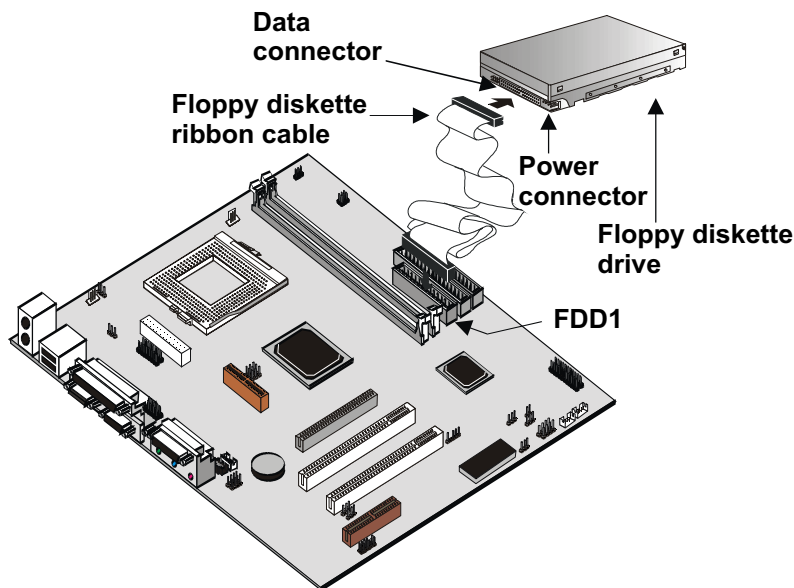

Using the Expansion Slots

This mainboard has two 32-bit PCI expansion slots, one 4xAGP slot, an AMR slot, and an optional TV-out/LCD panel link riser slot.

PCI Slots: The PCI slots can be used to install add-in cards that have the 32-bit PCI (Peripheral Components Interconnect) interface.

AGP Slot: The 4xAGP can be used to install a graphics adapter that supports the 4xAGP specification and has the 4xAGP edge connector.

AMR Slot: The Audio Modem Riser (AMR) slot can be used to insert an AMR card.

TV-out/LCD Panel Link Riser Slot (optional): This slot can be used to install a video-out port to allow the user to display to a TV or LCD panel.

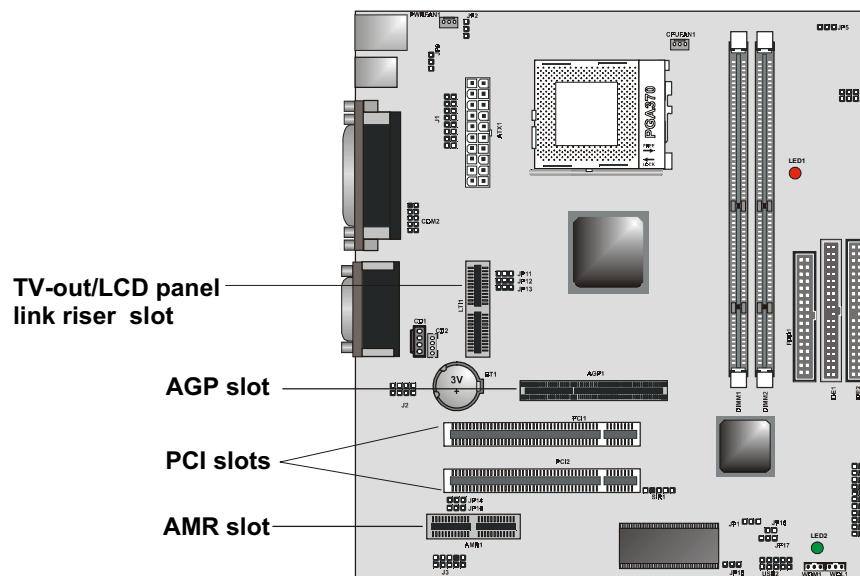

1. Before installing an expansion card, check the documentation for the card carefully. If the card is not Plug and Play, you may have to manually configure the card before installation.

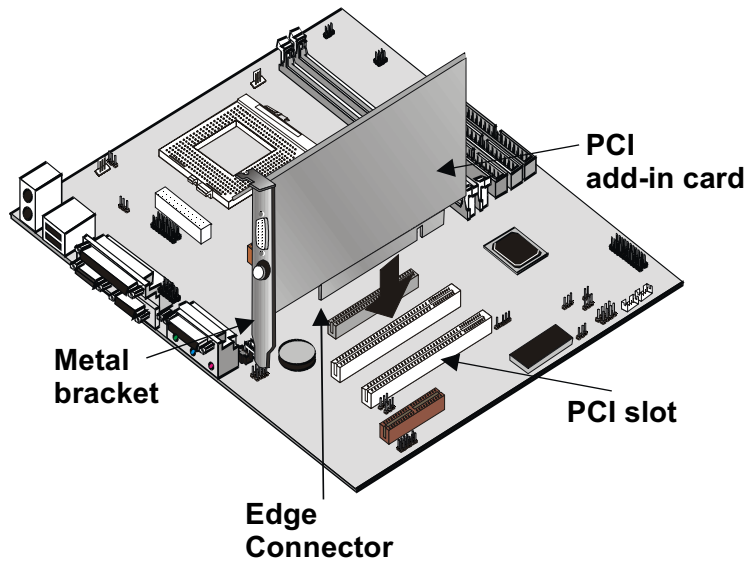

2. Remove the blanking plate from the slot in the system case that corresponds to the expansion slot that you are going to use.
3. Install the edge connector of the add-in card into the expansion slot. Press down quite firmly to ensure that the edge connector is correctly seated in the slot.
4. Secure the metal bracket of the card in the empty slot in the system case with a screw.
5. For some add-in cards, for example graphics adapters and network adapters, you have to install drivers and software before you can begin using the add-in card.

The following illustration shows how to insert an AMR card:

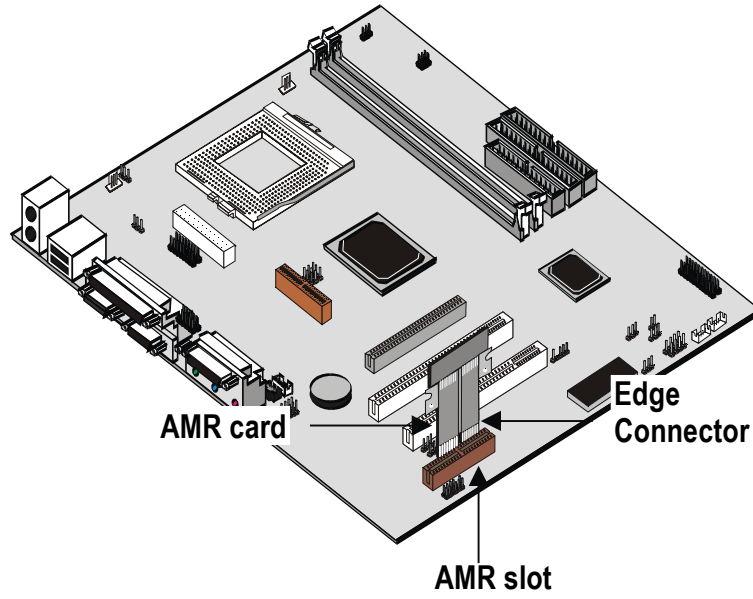

Add-in Card Options

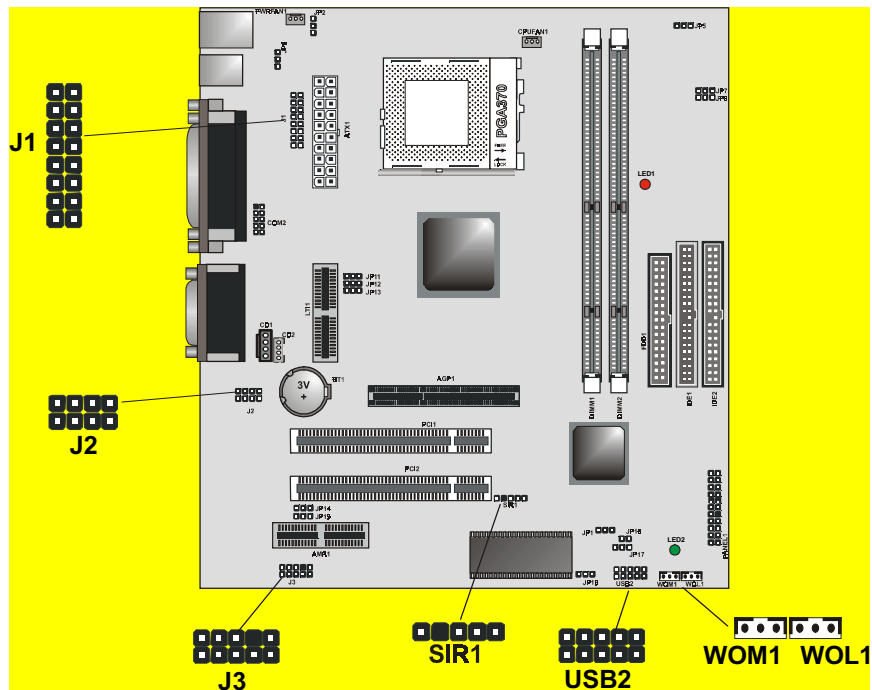

J1: Extra IR/keyboard/mouse header

This mainboard provides a second infrared, keyboard, and mouse header, giving the option of installing second infrared, keyboard, and mouse ports on the front panel. Depending on your case and system configuration this connector may be more suitable as the sole IR port connector.

J2: Extra MIC/Line-out header

This header allows the user to install auxiliary front-oriented microphone and line-out ports for easier access.

J3: LAN header

This header allows the user to attach an RJ-45 cable to access a Local Area Network (LAN). The mainboard is equipped with a LAN chip that supports 10 Mbps or 100 Mbps LAN connections.

SIR1: Infrared Port

This mainboard can support a Serial Infrared (SIR) data port. Infrared ports allow the wireless exchange of information between your computer and similarly equipped devices such as printers, laptops, Personal Digital Assistants (PDA), and other desktop computers.

USB2: USB ports 3/4 connector

Some cases come with USB ports on the front panel. If your case has these ports, you can connect them to the USB2 connector.

WOM1: Wake On Modem

If you have installed a fax/modem card, you can use the cable provided with the card to plug into the WOM1 connector on the mainboard. This is the Wake On Modem feature. When your system is in a power-saving mode, any incoming calls to the modem automatically resume the system. You must enable this item using the Power Management page of the setup utility. See Chapter 3 for more information.

WOL1: Wake On LAN

If you have installed a network adapter (LAN adapter), you can use the cable provided with the card to plug into the WOL connector on the mainboard. This is the Wake On LAN feature. When your system is in a power-saving mode, any traffic through the network automatically resumes the system. You must enable this item using the Power Management page of the Setup Utility. See Chapter 3 for more information.

Making External Connections

After you have installed the mainboard, make the connections to the external ports.

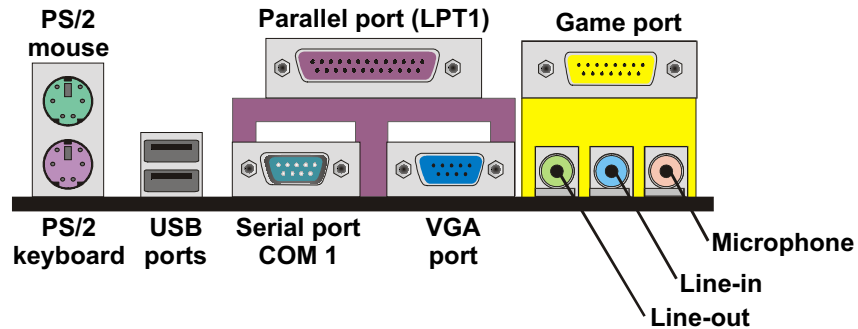

1. The mainboard has a stack of two PS/2 mini-DIN ports. The upper port can be used by a PS/2 mouse or pointing device. The lower port can be used by a PS/2 keyboard.
2. Use the USB ports to connect to USB devices.
3. LPT1 is a parallel port that can be used by printers or other parallel communications devices. The system identifies the parallel port as LPT1.
4. COM1 is a serial port that can be used by serial devices such as mice or fax/modems. COM1 is identified by the system as COM1/3.
5. The VGA port is used to attach an external monitor.
6. You can use the game port to connect a joystick or a MIDI device to your system.
7. Three audio ports are provided. The left side jack is for a stereo line-out signal. The middle jack is for a stereo line-in signal. The right side jack is for a microphone.

External Connector Color Coding

To help identify the external connectors, many connectors now use standard colors as shown in the table below.

Connector	Color
Analog VGA	Blue
Audio line in	Light blue
Audio line out	Lime
Digital monitor / flat panel	White
IEEE 1394	Grey
Microphone	Pink
MIDI/Game	Gold
Parallel	Burgundy
PS/2 compatible keyboard	Purple
PS/2 compatible mouse	Green
Serial	Teal or Turquoise
Speaker out/subwoofer	Orange
Right-to-left speaker	Brown
USB	Black
Video out	Yellow
SCSI, network, telephone, modem	None

—Notes—

Chapter 3: Setup

About the Setup Utility

The computer employs the latest Award BIOS CMOS chip with support for Windows Plug and Play. This CMOS chip contains the ROM setup instructions for configuring the mainboard's BIOS. The BIOS (Basic Input and Output System) Setup Utility is a ROM-based configuration utility that displays the system's configuration status and provides you with a tool to set system parameters. These parameters are stored in non-volatile battery-backed-up CMOS RAM that saves this information even when the power is turned off. When the system is turned back on, the system is configured with the values found in CMOS.

Using easy-to-use pull down menus, you can configure such items as:

- Hard drives, diskette drives, and peripherals
- Video display type and display options
- Password protection from unauthorized use
- Power management features

The settings made in the Setup Utility intimately affect how the computer performs. It is important, therefore, first to try to understand all the Setup Utility's options, and second, to make settings appropriate for the way you use the computer. This chapter guides you through the Setup Utility by providing clear explanations for all Setup Utility options.

A standard configuration has already been set in the Setup Utility, so you will very likely have little to worry about for now. However, we recommend that you read this chapter just in case you need to make any changes in the future.

This program should be executed under the following conditions:

- When changing the system configuration
- When a configuration error is detected by the system and you are prompted to make changes to the Setup Utility
- When resetting the system clock
- When redefining the communication ports to prevent any conflicts
- When making changes to the Power Management configuration
- When changing the password or making other changes to the security setup

Normally, running the Setup Utility is needed when the system hardware is not consistent with the information contained in the CMOS RAM, whenever the CMOS RAM has lost power, or the system features need to be changed.

Entering the Setup Utility

When the system is powered on, the BIOS will enter the Power-On Self Test (POST) routines. These routines perform various diagnostic checks; if an error is encountered, the error will be reported in one of two different ways:

1. If the error occurs before the display device is initialized, a series of beeps will be transmitted.
2. If the error occurs after the display device is initialized, the screen will display an error message.

After the POST routines are completed, the following message appears:

Press DEL to enter SETUP

To access the Award BIOS Setup Utility, press the delete key to display the “CMOS Setup Utility” screen:

CMOS Setup Utility – Copyright (C) 1984 – 2000 Award Software

<ul style="list-style-type: none"> ▶ Standard CMOS Features ▶ Advanced BIOS Features ▶ Advanced Chipset Features ▶ Integrated Peripherals ▶ Power Management Setup ▶ PnP/PCI Configurations ▶ PC Health Status 	<ul style="list-style-type: none"> ▶ Frequency/Voltage Control Load Fail-Safe Defaults Load Optimized Defaults Set Supervisor Password Set User Password Save & Exit Setup Exit Without Saving
Esc : Quit F9 : Menu in BIOS ↑ ↓ → ← : Select Item F10 : Save & Exit Setup	
Time, Date, Hard Disk Type . . .	

This screen provides access to the utility’s various functions.

BIOS Navigation Keys

Listed below are explanations of the keys displayed at the bottom of the screens:

Key	Function
Esc	Escape key: Exits the current menu
← ↓ ↑ →	Cursor keys: Scroll through the items on a menu
+/-/PU/PD	Plus, minus, Page Up and Page Down keys: Modify the selected field’s values
F10	F10 key: Saves the current configuration and exits setup
F1	F1 key: Displays a screen that explains all key functions
F5	F5 key: Loads previously saved values to CMOS
F6	F6 key: Loads a minimum configuration for troubleshooting.
F7	F7 key: Loads an optimum set of values for peak performance

Using BIOS

When you start the Setup Utility, the main menu appears. The main menu of the Setup Utility shows a list of the options that are available. A highlight indicates which option is currently selected. You can use the cursor arrow keys to move the highlight to other options. When an option is highlighted, you can execute the option by pressing the enter key.

Some options lead to pop-up dialog boxes that may ask you to verify that you wish to execute that option. You usually answer these dialogs by typing **Y** for yes and **N** for no. Some options may lead to more dialog boxes that ask for more information. Setting passwords have this kind of dialog box.

Enter Password:

Selecting some fields and pressing the enter key displays a list of options for that field. In the Standard CMOS Features screen, selecting "Drive A" and pressing <Enter> displays this screen:

Drive A			
None	[]	
360K , 5.25 in.	[]	
1.2M , 5.25 in.	[]	
720K , 3.5 in.	[]	
1.44M , 3.5 in.	[]	
2.88M , 3.5 in.	[]	

↑↓ : Move Enter : Accept ESC: Abort

Select the setting you want with the cursor keys. Press <Enter> to select, or <ESC> to discard changes and return to the previous menu. Alternatively, you can select a field and press the minus, plus, Page Up or Page Down keys to scroll through the options for that field.

Some options (marked with a triangle ►) lead to submenus that enable you to change the values for the option. Use the cursor arrow keys to scroll through the items in the submenu.

How to Flash a New BIOS

You can install updated BIOS for this mainboard that you can download from the manufacturer's web site. New BIOS may provide support for new peripherals, improvements in performance or fixes for known bugs. Install new BIOS as follows:

1. Some mainboards have a Flash BIOS jumper that protects the current BIOS from being changed or overwritten. If your mainboard has this jumper, change the setting to allow BIOS flashing.
2. Some Setup Utilities have an item called Firmware Write Protect that prevents the BIOS from being overwritten. If your BIOS has this item (check the Advanced BIOS Features Setup page) disable it for the present.
3. Your computer must be running in a real-mode DOS environment, not the DOS window of Windows NT or Windows 95/98. We recommend that you create a new formatted DOS system floppy diskette.
4. Download the Flash Utility and new BIOS file from the manufacturer's Web site. Copy these files to a system diskette.
5. Turn off your computer and insert the system diskette in your computer's diskette drive.
6. You might need to run the Setup Utility and change the boot priority items on the Advanced BIOS Features Setup page, to force your computer to boot from the floppy diskette drive first.
7. At the A:\ prompt, after your computer has booted to DOS from the diskette, run the Flash Utility and press <Enter>. You see a screen similar to the following.

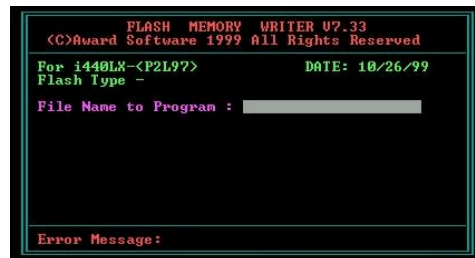

```
FLASH MEMORY WRITER V7.33
<C>Award Software 1999 All Rights Reserved
For i440LX-<P2L9?>          DATE: 10/26/99
Flash Type -
File Name to Program : _____
Error Message:
```

8. In the "File Name to Program" dialog box, type in the filename of the new BIOS and follow the onscreen directions to flash the new BIOS to the mainboard.
9. When the installation is complete, remove the floppy diskette from the diskette drive and restart your computer. If your mainboard has a Flash BIOS jumper, reset the jumper to protect the newly installed BIOS from being overwritten.

Standard CMOS Setup Option

This option displays a table of items defining basic information about your system.

CMOS Setup Utility – Copyright (C) 1984 – 2000 Award Software
Standard CMOS Features

Date (mm:dd:yy)	Tue, Feb 15 2000	Item Help
Time (hh:mm:ss)	12 : 8 : 59	
▶ IDE Primary Master	Press Enter None	Menu Level ▶ Change the day, month, year and century.
▶ IDE Primary Slave	Press Enter None	
▶ IDE Secondary Master	Press Enter None	
▶ IDE Secondary Slave	Press Enter None	
Drive A	1.44M, 3.5 in.	
Drive B	None	
Floppy 3 mode Support	Disabled	
Video	EGA/VGA	
Halt On	All Errors	
Base Memory	640K	
Extended Memory	63488	
Total Memory	64512K	

↑ ↓ → ← : Move Enter : Select +/-/PU/PD:Value: F10: Save ESC: Exit F1:General Help
F5:Previous Values F6:Fail-Safe Defaults F7:Optimized Defaults

Date and Time

The Date and Time items show the current date and time held by your computer. If you are running a Windows OS, these items are automatically updated whenever you make changes to the Windows Date and Time Properties utility.

▶ IDE Devices **Default: None**

Your computer has two IDE channels (Primary and Secondary) and each channel can be installed with one or two devices (Master and Slave). Use these items to configure each device on the IDE channel. Press <Enter> to display the IDE sub-menu:

CMOS Setup Utility – Copyright (C) 1984 – 2000 Award Software
 IDE Primary Master

IDE HDD Auto-Detection	Press Enter	Item Help
IDE Primary Master	Auto	Menu Level ►►
Access Mode	Auto	To auto-detect the HDD's size, head . . . on this channel
Capacity	8448 MB	
Cylinder	16368	
Head	16	
Precomp	0	
Landing Zone	16367	
Sector	63	

↑↓ → ← : Move Enter : Select +/-/PU/PD: Value: F10: Save ESC: Exit F1: General Help
 F5: Previous Values F6: Fail-Safe Defaults F7: Optimized Defaults

IDE HDD Auto-Detection

Press <Enter> while this item is highlighted if you want the Setup Utility to automatically detect and configure a hard disk drive on the IDE channel.

Note: If you are setting up a new hard disk drive that supports LBA mode, more than one line will appear in the parameter box. Choose the line that lists LBA for an LBA drive.

IDE Primary/Secondary Master/Slave

If you leave this item at Auto, the system will automatically detect and configure any IDE devices it finds. If it fails to find a hard disk, change the value to Manual and then manually configure the drive by entering the characteristics of the drive in the items below (Capacity, Cylinder, Head, Precomp, etc.) Refer to your drive's documentation or look on the drive if you need to obtain this information. If no device is installed, change the value to None.

Note: Before attempting to configure a hard disk drive, make sure you have the configuration information supplied by the manufacturer of your hard drive. Incorrect settings can result in your system not recognizing the installed hard disk.

Access Mode

This item defines some special ways that can be used to access IDE hard disks such as LBA (Large Block Addressing). Leave this value at Auto and the system will automatically decide the fastest way to access the hard disk drive.

Press <Esc> to close the IDE device sub-menu and return to the Standard CMOS Features page.

Drive A and Drive B **Default: 1.44M, 3.5 in., None**

These items define the characteristics of any diskette drive attached to the system. You can connect one or two diskette drives.

Floppy 3 Mode Support **Default: Disabled**

Floppy 3 mode refers to a 3.5-inch diskette with a capacity of 1.2 MB. Floppy 3 mode is sometimes used in Japan.

Video **Default: EGA/VGA**

This item defines the video mode of the system. This mainboard has a built-in VGA graphics system; you must leave this item at the default value.

Halt On **Default: All Errors**

This item defines the operation of the system POST (Power On Self Test) routine. You can use this item to select which types of errors in the POST are sufficient to halt the system.

Base Memory, Extended Memory, and Total Memory

These items are automatically detected by the system at start up time. These are display-only fields. You cannot make changes to these fields.

H/W Reset Function ***Default: Enabled***

Enables or disables the computer's hardware reset button. The default setting is Enabled.

CPU Internal Cache CPU Internal Cache ***Default: Enabled***

All the processors that can be installed in this mainboard use internal level 1 (L1) cache memory to improve performance. Leave this item at the default value Enabled for better performance.

External Cache ***Default: Enabled***

Most processors that can be installed in this system use external level 2 (L2) cache memory to improve performance.

CPU L2 Cache ECC Checking ***Default: Enabled***

This item enables or disables ECC (Error Correction Code) error checking on the CPU cache memory. We recommend that you leave this item at the default value.

Processor Number Feature ***Default: Enabled***

Some new processors are installed with a unique processor number. This number may be used for verification in Internet transactions and e-commerce. If you prefer not to use or distribute the unique processor number, set this item to Disabled to suppress the processor number.

Quick Power On Self Test ***Default: Enabled***

You can enable this item to shorten the power on testing (POST) and have your system start up a little faster. You might like to enable this item after you are confident that your system hardware is operating smoothly.

1st/2nd/3rd Boot Device ***Default: Floppy/HDD-0/LS/ZIP***

Use these three items to select the priority and order of the devices that your system searches for an operating system at start-up time.

Boot Other Device ***Default: Enabled***

If you enable this item, the system will search all other possible locations for an operating system if it fails to find one in the devices specified under the first, second and third boot devices.

Swap Floppy Drive**Default: Disabled**

If you have two floppy diskette drives in your system, this item allows you to swap the assigned drive letters so that drive A becomes drive B, and drive B becomes drive A.

Boot Up Floppy Seek**Default: Enabled**

If this item is enabled, it checks the geometry of the floppy disk drives at start-up time. You don't need to enable this item unless you have a legacy diskette drive with 360K capacity.

Boot Up NumLock Status**Default: On**

This item defines if the keyboard Num Lock key is active when your system is started.

Gate A20 Option**Default: Normal**

This item defines how the system handles legacy software that was written for an earlier generation of processors. Leave this item at the default value.

Typematic Rate Setting**Default: Disabled**

If this item is enabled, you can use the following two items to set the typematic rate and the typematic delay settings for your keyboard.

Typematic Rate (Chars/Sec)**Default: 6**

If Typematic Rate Setting is enabled, you can use this item to define how many characters per second are generated by a held-down key.

Typematic Delay (Msec)**Default: 250**

If Typematic Rate Setting is enabled, you can use this item to define how many milliseconds must elapse before a held-down key begins generating repeat characters.

Security Option**Default: Setup**

If you have installed password protection, this item defines if the password is required at system start up, or if it is only required when a user tries to enter the Setup Utility.

OS Select For DRAM > 64 MB **Default: Non-OS2**

This item is only required if you have installed more than 64 MB of memory and you are running the OS/2 operating system. Otherwise, leave this item at the default Non-OS2.

HDD S.M.A.R.T Capability **Default: Disabled**

The S.M.A.R.T. (Self-Monitoring, Analysis, and Reporting Technology) system is a diagnostics technology that monitors and predicts device performance. S.M.A.R.T. software resides on both the disk drive and the host computer. The disk drive software monitors the internal performance of the motors, media, heads, and electronics of the drive. The host software monitors the overall reliability status of the drive. If a device failure is predicted, the host software, through the Client WORKS S.M.A.R.T applet, warns the user of the impending condition and advises appropriate action to protect the data.

Report No FDD For WIN95 **Default: Yes**

If you are running a system with no floppy drive and using Windows 95, select Yes for this item to ensure compatibility with the Windows 95 logo certification. Otherwise, select No.

Video BIOS Shadow **Default: Enabled**

When enabled, copies the VGA BIOS into system DRAM for better performance.

C8000-CBFFF ~ DC000-DFFFF Shadow **Default: Disabled**

These categories determine whether option ROMs will be copied to RAM. An example of such option ROM would be support of on-board SCSI. The default value for each item is Disabled.

Advanced Chipset Features Option

This option displays a table of items that define critical timing parameters of the mainboard components including the memory, and the system logic. Generally, you should leave the items on this page at their default values unless you are very familiar with the technical specifications of your system hardware. If you change the values incorrectly, you may introduce fatal errors or recurring instability into your system.

CMOS Setup Utility – Copyright (C) 1984 – 2000 Award Software
Advanced Chipset Features

Bank 0/1 DRAM Timing	SDRAM 8/10ns		Item Help
Bank 2/3 DRAM Timing	SDRAM 8/10ns		
SDRAM Cycle Length	3		Menu Level ▶
DRAM Clock	Host CLK		
Memory Hole	Disabled		
P2C/C2P Concurrency	Enabled		
Fast R-W Turn Around	Disabled		
System BIOS Cacheable	Enabled		
Video RAM Cacheable	Enabled		
OnChip AGP VGA	Enabled		
Frame Buffer Size	8M		
AGP Aperture Size	64M		
AGP-4X Mode	Enabled		
AGP Driving Control	Auto		
x AGP Driving Value	DA		
OnChip USB	Enabled		
USB Keyboard Support	Disabled		
OnChip Sound	Auto		

↑ ↓ → ← : Move Enter : Select +/-/PU/PD:Value: F10: Save ESC: Exit F1:General Help
F5:Previous Values F6:Fail-Safe Defaults F7:Optimized Defaults

Bank 0/1 2/3 DRAM Timing **Default: 8/10 ns**

The DRAM timing is controlled by the DRAM Timing Registers. The timings programmed into this register are dependent on the system design. Slower rates may be required in certain system designs to support loose layouts or slower memory.

SDRAM Cycle Length **Default: 3**

This item sets the timing and wait states for SDRAM memory. We recommend that you leave this item at the default value.

DRAM Clock **Default: Host CLK**

This item sets the DRAM Clock. We recommend that you leave this item at the default value.

Memory Hole **Default: Disabled**

This item can be used to reserve memory space for some ISA expansion cards that require it.

P2C/C2P Concurrency **Default: Enabled**

When disabled, the CPU bus is occupied during the entire PCI operation period.

Fast R-W Turn Around **Default: Disabled**

When this is enabled, the chipset will insert one extra clock to the turn-around of back-to-back DRAM cycles.

System BIOS Cacheable **Default: Enabled**
Video RAM Cacheable **Default: Enabled**

These items allow the video and/or system to be cached in memory for faster execution. We recommend that you leave these items at the default value.

OnChip AGP VGA **Default: Enabled**

This item allows the user to select the type of VGA used.

Frame Buffer Size **Default: 8M**

This feature controls the size of the memory allotment given to the display adapter to accelerate screen-redrawing time.

AGP Aperture Size **Default: 64 MB**

This item defines the size of the aperture if you use an AGP graphics adapter. It refers to a section of the PCI memory address range used for graphics memory. We recommend that you leave this item at the default value.

AGP-4X Mode **Default: Enabled**

This item allows you to enable or disable the caching of display data for the video memory of the processor. Enabling AGP-4X Mode can greatly improve the display speed. If your graphics display card does not support this feature, you need to disable this item.

AGP Driving Control **Default: Auto**

This item can be used to signal driving current on AGP cards to auto or Manual. Some AGP cards need stronger than normal driving current in order to operate. We recommend that you set this item to Auto by default.

AGP Driving Value **Default: DA**

When the previous item AGP Driving Control is set to Manual, you can use this item to set the AGP current driving value.

OnChip USB **Default: Enabled**

This should be enabled if your system has a USB installed on the system board and you wish to use it.

USB Keyboard Support **Default: Disabled**

Enable this item if you plan to use a keyboard connected through the USB port in a legacy operating system (such as DOS) that does not support Plug and Play.

OnChip Sound **Default: Auto**

When set to Disabled, the onboard audio chip is turned off.

Onboard PCI LAN **Default: Enabled**

Enable this item to use the onboard LAN controller. If you are installing a LAN card, disable this item.

CPU to PCI Write Buffer **Default: Enabled**

When enabled, up to four words of data can be written to the PCI bus without interrupting the CPU. When disabled, a write buffer is not used and the CPU read cycle will not be completed until the PCI bus signals that it is ready to receive the data. The default setting is Enabled.

PCI Dynamic Bursting **Default: Enabled**

When set to Enabled, every write transaction goes to the write buffer. Burstable transactions then "burst" on the PCI bus and nonburstable transaction do not.

PCI Master 0 WS Write **Default: Enabled**

When set to Enabled, writes to the PCI bus are executed with zero wait states.

PCI Delay Transaction**Default: Disabled**

The chipset has an embedded 32-bit posted write buffer to support delay transactions cycles. Select Enabled to support compliance with PCI specification version 2.1.

PCI#2 Access #1 Retry**Default: Enabled**

When set to Enabled, the AGP Bus (PCI#2) access to PCI Bus (PCI#1) is executed with the error retry feature.

AGP Master 1 WS Write**Default: Disabled**

This implements a single delay when writing to the AGP Bus. By default, two-wait states are used by the system, allowing for greater stability.

AGP Master 1 WS Read**Default: Disabled**

This implements a single delay when reading to the AGP Bus. By default, two-wait states are used by the system, allowing for greater stability.

P6 Lock Function**Default: Disabled**

The P6 CPU has a PCI LOCK function to lock the PCI BUS, enabling efficient sharing of the PCI BUS with the PCI DEVICE and CPU.

Integrated Peripherals Option

This option displays a list of items that defines the operation of some peripheral components on the system's input/output ports.

CMOS Setup Utility – Copyright (C) 1984 – 2000 Award Software
Integrated Peripherals

OnChip IDE Channel0	Enabled		Item Help
OnChip IDE Channel1	Enabled		Menu Level ▶
IDE Prefetch Mode	Enabled		
Primary Master PIO	Auto		
Primary Slave PIO	Auto		
Secondary Master PIO	Auto		
Secondary Slave PIO	Auto		
Primary Master UDMA	Auto		
Primary Slave UDMA	Auto		
Secondary Master UDMA	Auto		
Secondary Slave UDMA	Auto		
Init Display First	PCI Slot		
IDE HDD Block Mode	Enabled		
Onboard FDD Controller	Enabled		
Onboard Serial Port 1	Auto		
Onboard Serial Port 2	Auto		
UART 2 Mode	Standard		
x IR Function Duplex	Half		
x TX,RX inverting enable	No, Yes		

↑ ↓ → ← : Move Enter : Select +/-/PU/PD:Value: F10: Save ESC: Exit F1:General Help
F5:Previous Values F6:Fail-Safe Defaults F7:Optimized Defaults

On-Chip IDE Channel 0/1 ***Default: Enabled***

Use these items to enable or disable the PCI IDE channels that are integrated on the mainboard.

IDE Primary/Secondary Master/Slave PIO ***Default: Auto***

Each IDE channel supports a master device and a slave device. These four items let you assign which kind of PIO (Programmed Input/Output) is used by IDE devices. You can choose Auto, to let the system auto detect which PIO mode is best, or you can install a PIO mode from 0-4.

IDE Primary/Secondary Master/Slave UDMA ***Default: Auto***

Each IDE channel supports a master device and a slave device. This mainboard supports UltraDMA. UltraDMA technology provides faster access to IDE devices.

If you install a device that supports UltraDMA, change the appropriate item on this list to Auto. You may have to install the UltraDMA driver supplied with this mainboard in order to use an UltraDMA device.

Init Display First**Default: PCI Slot**

Use this item to define if your graphics adapter is installed in one of the PCI slots or select Onboard if you have a graphics system integrated on the mainboard.

IDE HDD Block Mode**Default: Enabled**

Enable this field if your IDE hard drive supports block mode. Block mode enables BIOS to automatically detect the optimal number of block read and writes per sector that the drive can support and can improve the speed of access to IDE devices.

Onboard FDD Controller**Default: Enabled**

This option enables the onboard floppy disk drive controller.

Onboard Serial Port 1/Serial Port 2**Default: Auto**

These options are used to assign the I/O addresses for the two onboard serial ports.

UART 2 Mode**Default: Standard**

This field is available if the Onboard Serial Port 2 field is set to any option but Disabled. UART Mode Select enables you to select the infrared communication protocol—Standard (default), HPSIR or ASKIR. HPSIR is Hewlett Packard's infrared communication protocol with a maximum baud rate up to 115.2K bps. ASKIR is Sharp's infrared communication protocol with a maximum baud rate up to 57.6K bps.

The UART mode setting depends on which type of infrared module is used in the system. When set to ASKIR or HPSIR, the UART 2 is used to support the infrared module connected on the mainboard. If this option is not set to Standard, a device connected to the COM2 port will no longer work.

IR Function Duplex**Default: Half**

This field is available when UART 2 Mode is set to either ASKIR or HPSIR. This item enables you to determine the infrared (IR) function of the onboard infrared chip. The options are Full and Half (default).

Full-duplex means that you can transmit and send information simultaneously. Half-duplex is the transmission of data in both directions, but only one direction at a time.

TX,RX inverting enable ***Default: No, Yes***

Defines the voltage level for Infrared module RxD (receive) mode and TxD (transmit) mode. This setting has to match the requirements of the infrared module used in the system.

Onboard Parallel Port ***Default: 378/IRQ7***

This option is used to assign the I/O address for the onboard parallel port.

Onboard Parallel Port Mode ***Default: ECP***

Enables you to set the data transfer protocol for your parallel port. There are four options: Normal (Standard Parallel Port), EPP (Enhanced Parallel Port), ECP (Extended Capabilities Port) and ECP+EPP.

Normal allows data output only. Extended Capabilities Port (ECP) and Enhanced Parallel Port (EPP) are bi-directional modes, allowing both data input and output. ECP and EPP modes are only supported with EPP and ECP aware peripherals.

ECP Mode Use DMA ***Default: 3***

When the onboard parallel port is set to ECP mode, the parallel port has the option to use DMA 3 (default) or DMA 1.

Parallel Port EPP Type ***Default: EPP1.7***

Sets the EPP specification. There are two options, EPP1.9 and EPP1.7.

If you make any changes to the onboard FDD controller, serial ports or parallel ports in this setup, save the changes and turn off the system. After powering up the system, ensure that the changes have taken effect.

Onboard Legacy Audio ***Default: Enable***

Enables the onboard legacy audio function. If this item is enabled the following items become available.

Sound Blaster ***Default: Enabled***

Enables or disables Sound Blaster function.

SB I/O Base Address **Default: 220H**

This item lets you set the I/O base address for the Sound Blaster card.

SB IRQ Select **Default: IRQ 5**

This item lets you set the Interrupt Request (IRQ) for the Sound Blaster card.

SB DMA Select **Default: DMA 1**

This item lets you select the DMA for the Sound Blaster card.

MPU-401 **Default: Enabled**

Use this item to enable or disable the MPU-401 (MIDI) function for the game port. The default is Disabled.

MPU-401 I/O Address **Default: 330-333H**

Use this item to set the I/O address for the MPU-401 (MIDI) function.

Game Port (200-207H) **Default: Enabled**

This item sets the I/O address for the game port.

Power Management Setup Option

This option displays items that let you control the system power management. Modern operating systems take care of much of the power management. This mainboard supports ACPI (Advanced Configuration and Power Interface). The system has various power saving modes including powering down the hard disk, turning off the video, suspending to RAM, and a software power down that allows the system to be automatically resumed by certain events.

Power Management Timeouts

The power-saving modes can be controlled by timeouts. If the system is inactive for a time, the timeouts begin counting. If the inactivity continues so that the timeout period elapses, the system enters a power-saving mode. If any item in the list of Reload Global Timer Events is Enabled, then any activity on that item will reset the timeout counters to zero.

Wake Up Calls

If the system is suspended, or has been powered down by software, it can be resumed by a wake up call that is generated by incoming traffic to a modem, a LAN card, a PCI card, or a fixed alarm on the system realtime clock,

CMOS Setup Utility – Copyright (C) 1984 – 2000 Award Software
Power Management Setup

	Enabled	Item Help
▶ ACPI Function	Enabled	
▶ Power Management	Press Enter	
ACPI Suspend Type	S1(POS)	Menu Level ▶
PM Control by APM	Yes	
Video Off Option	Suspend -> Off	
Video Off Method	DPMS Support	
MODEM Use IRQ	3	
Soft-Off by PWRBTN	Instant-Off	
Keyboard Power On	Disabled	
▶ Wake Up Events	Press Enter	

↑ ↓ → ← : Move Enter : Select +/-/PU/PD:Value: F10: Save ESC: Exit F1:General Help
F5:Previous Values F6:Fail-Safe Defaults F7:Optimized Defaults

ACPI Function**Default: Enabled**

This mainboard supports ACPI (Advanced Configuration and Power management Interface). Use this item to enable or disable the ACPI feature.

Note: *ACPI is a power management specification that makes hardware status information available to the operating system. ACPI enables a PC to turn its peripherals on and off for improved power management. It also allows the PC to be turned on and off by external devices, so that mouse or keyboard activity wakes up the computer.*

Power Management

This item enables you to choose the type of Power Management you want. Selecting Power Management and pressing Enter displays the following screen:

CMOS Setup Utility – Copyright (C) 1984 – 2000 Award Software
Power Management

Power Management	User Define	Item Help
HDD Power Down	Disable	
Doze Mode	Disabled	Menu Level ▶▶
Suspend Mode	Disable	

↑↓ → ← : Move Enter : Select +/-/PU/PD:Value: F10: Save ESC: Exit F1:General Help
F5:Previous Values F6:Fail-Safe Defaults F7:Optimized Defaults

This menu enables you to set the following items:

Power Management**Default: User Define**

This item acts like a master switch for the power-saving modes and hard disk timeouts. If this item is set to Max Saving, power-saving modes occur after a short timeout. If this item is set to Min Saving, power-saving modes occur after a longer timeout. If the item is set to User Define, you can insert your own timeouts for the power-saving modes.

HDD Power Down **Default: Disable**

The IDE hard drive will spin down if it is not accessed within a specified length of time. Options are from 1 Min to 15 Min and Disable.

Doze Mode **Default: Disable**

The system speed will change from turbo to slow if no Power Management events occur for a specified length of time. Full power function will return when a Power Management event is detected.

Suspend Mode **Default: Disable**

The CPU clock will be stopped and the video signal will be suspended if no Power Management events occur for a specified length of time. Full power function will return when a Power Management event is detected. Options are from 1 Min to 1 Hour and Disable.

ACPI Suspend Type **Default: S1 (POS)**

Use this item to define how your system suspends. In the default, S1(POS), the suspend mode is equivalent to a software power down. If you select S3 (STR), the suspend mode is a suspend to RAM – the system shuts down with the exception of a refresh current to the system memory.

PM Control by APM **Default: Yes**

This field allows you to control the PC Monitor's power management features via Intel-Microsoft Advanced Power Management software. Once you have enabled the APM interface, some settings made in the BIOS Setup program may be overridden by APM.

Video Off Option **Default: Suspend --> Off**

This option defines if the video is powered down when the system is put into suspend mode.

Video Off Method **Default: DPMS Support**

This item defines how the video is powered down to save power. This item is set to DPMS (Display Power Management Software) by default.

MODEM Use IRQ**Default: 3**

If you want an incoming call on a modem to automatically resume the system from a power-saving mode, use this item to specify the interrupt request line (IRQ) that is used by the modem. You might have to connect the fax/modem to the mainboard Wake On Modem connector for this feature to work.

Soft-Off by PWRBTN**Default: Instant-Off**

Under ACPI (Advanced Configuration and Power management Interface) you can create a software power down. In a software power down, the system can be resumed by Wake Up Alarms. This item lets you install a software power down that is controlled by the normal power button on your system. If the item is set to Instant-Off, then the power button causes a software power down. If the item is set to Delay 4 Sec. then you have to hold the power button down for four seconds to cause a software power down.

Keyboard Power On**Default: Disabled**

Enable this item to allow the system to be resumed from a software powerdown or a power-saving mode by a keystroke on the keyboard.

Wake Up Events

This item opens a submenu that enables you to set events that will resume the system from a power saving mode. Select Wake Up Events and press Enter to display the following menu:

CMOS Setup Utility – Copyright (C) 1984 – 2000 Award Software
Wake Up Events

USB Resume from S3/S4/S5	Disabled	Item Help
VGA	OFF	
LPT & COM	LPT/COM	Menu Level ▶▶
HDD & FDD	ON	
PCI Master	OFF	
PowerOn by PCI Card	Disabled	
Wake Up On LAN/Ring	Disabled	
RTC Alarm Resume	Disabled	
x Date (of Month)	0	
x Resume Time (hh:mm:ss)	0 0 15	
Primary INTR	ON	
▶ Activity Monitoring	Press Enter	

↑ ↓ → ← : Move Enter : Select +/-/PU/PD:Value: F10: Save ESC: Exit F1:General Help
F5:Previous Values F6:Fail-Safe Defaults F7:Optimized Defaults

USB Resume from S3/S4/S5 **Default: Disabled**

Use this item to enable USB activity to wakeup the system from a power saving mode.

VGA **Default: Off**

When set to On, the system power will resume the system from a power saving mode if there is any VGA activity. Default is Off.

LPT & COM **Default: LPT/COM**

When this item is enabled, the system will restart the power-saving timeout counters when any activity is detected on the serial ports, or the parallel port.

HDD & FDD **Default: ON**

When this item is enabled, the system will restart the power-saving timeout counters when any activity is detected on the hard disk drive or the floppy diskette drive.

PCI Master **Default: Off**

When set to Off any PCI device with Master function will not power on the system.

PowerOn by PCI Card **Default: Disabled**

Use this item to enable PCI activity to wakeup the system from a power saving mode.

Wake Up On LAN/Ring **Default: Disabled**

Use this item to enable LAN or modem activity to wakeup the system from a power saving mode.

RTC Alarm Resume **Default: Disabled**

When set to Enabled, the following two fields become available and you can set the date (day of the month), hour, minute and second to turn on your system. When set to 0 (zero) for the day of the month, the alarm will power on your system every day at the specified time.

Primary INTR **Default: ON**

Set Primary INTR to ON to allow you to enable or disable IRQ 3 through IRQ 15 activity monitoring. Set it to OFF to disable IRQ activity monitoring.

IRQs Activity Monitoring

This item opens a submenu that enables you to set IRQs that will resume the system from a power saving mode. Select IRQs Activity Monitoring and press <Enter> to display the following menu:

CMOS Setup Utility – Copyright (C) 1984 – 2000 Award Software
IRQs Activity Monitoring

IRQ 3 (COM2)	Enabled	Item Help
IRQ 4 (COM1)	Enabled	
IRQ 5 (LPT2)	Enabled	Menu Level ►►►
IRQ 6 (Floppy Disk)	Enabled	
IRQ 7 (LPT1)	Enabled	
IRQ 8 (RTC Alarm)	Disabled	
IRQ 9 (IRQ2 Redir)	Disabled	
IRQ 10 (Reserved)	Disabled	
IRQ 11 (Reserved)	Disabled	
IRQ 12 (PS/2 Mouse)	Enabled	
IRQ 13 (Coprocessor)	Disabled	
IRQ 14 (Hard Disk)	Enabled	
IRQ 15 (Reserved)	Disabled	

↑↓→← : Move Enter : Select +/-/PU/PD:Value: F10: Save ESC: Exit F1:General Help
F5:Previous Values F6:Fail-Safe Defaults F7:Optimized Defaults

Set any IRQ to Enabled to allow activity at the IRQ to wake up the system from a power saving mode.

PNP/PCI Configuration Option

This option displays a table of items that configures how PnP (Plug and Play) and PCI expansion cards operate in your system. Both the ISA and PCI buses on the Mainboard use system IRQs (Interrupt ReQuests) and DMAs (Direct Memory Access). You must set up the IRQ and DMA assignments correctly through the PnP/PCI Configurations Setup utility; otherwise, the mainboard will not work properly. Selecting PnP/PCI Configurations on the main program screen displays this menu:

CMOS Setup Utility – Copyright (C) 1984 – 2000 Award Software
PnP/PCI Configurations

		Item Help
PNP OS Installed	No	
Reset Configuration Data	Disabled	
Resources Controlled by	Auto(ESCD)	Menu Level ►
x IRQ Resources	Press Enter	Select Yes if you are using a Plug and Play capable operating system. Select No if you need the BIOS to configure non-boot devices.
x DMA Resources	Press Enter	
PCI/VGA Palette Snoop	Disabled	
Assign IRQ For VGA	Enabled	
Assign IRQ For USB	Enabled	
INT Pin 1 Assignment	Auto	
INT Pin 2 Assignment	Auto	
INT Pin 3 Assignment	Auto	
INT Pin 4 Assignment	Auto	

↑↓→← : Move Enter : Select +/-/PU/PD:Value: F10: Save ESC: Exit F1:General
Help F5:Previous Values F6:Fail-Safe Defaults F7:Optimized Defaults

PNP OS Installed

Default: No

Setting this option to Yes allows the PnP OS (instead of BIOS) to assign the system resources such as IRQ and I/O address to the ISA PnP device. The default setting is No.

Reset Configuration Data

Default: Disabled

If you enable this item and restart the system, any Plug and Play configuration data stored in the BIOS setup is cleared from memory. New updated data is created.

Resources Controlled By **Default: Auto(ESCD)**

You should leave this item at the default Auto(ESCD). Under this setting, the system dynamically allocates resources to plug and play devices as they are required.

If you cannot get a legacy ISA (Industry Standard Architecture) expansion card to work properly, you might be able to solve the problem by changing this item to Manual, and then opening up the IRQ Resources and Memory Resources sub-menus.

In the *IRQ Resources* sub-menu, if you change any of the IRQ assignments to Legacy ISA, then that Interrupt Request Line is reserved for a legacy ISA expansion card. Press <Esc> to close the IRQ Resources sub-menu.

In the *Memory Resources* sub menu, use the first item Reserved Memory Base to set the start address of the memory you want to reserve for the ISA expansion card. Use the second item Reserved Memory Length to set the amount of reserved memory. Press <Esc> to close the Memory Resources sub-menu.

PCI/VGA Palette Snoop **Default: Disabled**

This item is designed to overcome some problems that can be caused by some non-standard VGA cards. This board includes a built-in VGA system that does not require palette snooping so you must leave this item disabled.

Assign IRQ for VGA/USB **Default: Enabled**

Names the interrupt request (IRQ) line assigned to the USB/VGA (if any) on your system. Activity of the selected IRQ always awakens the system.

INT Pin 1 ~ Pin 4 Assignment **Default: Auto**

Names the interrupt request (IRQ) line assigned to PCI 1 through PCI 4 on your system. Activity of the selected PCI slot awakens the system.

PCI Health Status Option

On mainboards that support hardware monitoring, this item lets you monitor the parameters for critical voltages, critical temperatures, and fan speeds. You cannot make any changes to these fields. They are display only:

CMOS Setup Utility – Copyright (C) 1984 – 2000 Award Software
PC Health Status

Shutdown Temperature	Disabled	Item Help
Current CPU Temp.		Menu Level ▶
Current System Temp.		
CPU FAN Speed		
Power FAN Speed		
Vcore		
2.5V		
3.3V		
5V		
12V		

↑↓ → ← : Move Enter : Select +/-/PU/PD:Value: F10: Save ESC: Exit F1:General
Help F5:Previous Values F6:Fail-Safe Defaults F7:Optimized Defaults

Shutdown Temperature

Enables you to set the maximum temperature the system can reach before powering down.

System Component Characteristics

These fields provide you with information about the systems current operating status. You cannot make changes to these fields. The following information is displayed:

- CPU temperature in degrees Fahrenheit and Celsius
- System temperature in degrees Fahrenheit and Celsius
- CPU fan speed (in RPMs)
- Power fan speed (in RPMs)
- Vcore (CPU core voltage)
- VCC SRAM (CPU L2 cache voltage)
- Vcc3 (onboard 3.3 volt)
- Power supply's ± 5 volt
- Power supply's ±12 volt

Frequency Control Option

This item enables you to set the clock speed and system bus for your system. The clock speed and system bus are determined by the kind of processor you have installed in your system.

CMOS Setup Utility – Copyright (C) 1984 – 2000 Award Software
Frequency Control

Auto Detect DIMM/PCI Clk	Enabled	Item Help
Spread Spectrum	Disabled	
CPU Host/PCI Clock	Default	Menu Level ▶
CPU Clock Ratio	Auto	
CPU clock failed reset	Disabled	

↑ ↓ → ← : Move Enter : Select +/-/PU/PD:Value: F10: Save ESC: Exit F1:General Help
F5:Previous Values F6:Fail-Safe Defaults F7:Optimized Defaults

Auto Detect DIMM/PCI Clk **Default: Enabled**

When this item is enabled, BIOS will disable the clock signal of free DIMM and PCI slots.

Spread Spectrum Modulated **Default: Disabled**

If you enable spread spectrum, it can significantly reduce the EMI (Electro-Magnetic Interference) generated by the system.

CPU Host/PCI Clock **Default: Default**

These items appear if you have set the *CPU Internal Core Speed* to Manual. Use the *CPU/DIMM/PCI Clock* to set the frontside bus frequency for the installed processor (usually 133 MHz, 100 MHz or 66 MHz). Then use *CPU Clock Ratio* to set a multiple.

CPU Clock Ratio **Default: Auto**

Use this item to select a multiplier for the system frontside bus (FSB) frequency. The value of the multiplier must be set so that:

$$\text{Multiplier} \times \text{Frontside Bus Frequency} = \text{CPU Clock Speed}$$

For example, if you have a processor that is rated to run at 450 MHz and the system is running a frontside bus frequency of 100 MHz, you should select a multiplier of 4.5 so that:

$$4.5 \text{ (Multiplier)} \times 100 \text{ MHz (frontside bus)} = 450 \text{ MHz (CPU clock)}$$

CPU Clock failed reset**Default: Disabled**

When this item is enabled and the system crashes three times because the processor has been overclocked, the BIOS will automatically adjust the speed of the processor to the system bus speed multiplied by two.

Load Fail-Safe Defaults Option

This option opens a dialog box that lets you install fail-safe defaults for all appropriate items in the Setup Utility. Press <Y> and then <Enter> to install the defaults. Press <N> and then <Enter> to not install the defaults. The fail-safe defaults place no great demands on the system and are generally stable. If your system is not functioning correctly, try installing the fail-safe defaults as a first step in getting your system working properly again. If you only want to install fail-safe defaults for a specific option, select and display that option, and then press <F6>.

Load Optimized Defaults Option

This option opens a dialog box that lets you install optimized defaults for all appropriate items in the Setup Utility. Press <Y> and then <Enter> to install the defaults. Press <N> and then <Enter> to not install the defaults. The optimized defaults place demands on the system that may be greater than the performance level of the components, such as the CPU and the memory. You can cause fatal errors or instability if you install the optimized defaults when your hardware does not support them. If you only want to install setup defaults for a specific option, select and display that option, and then press <F7>.

Set Supervisor and User Passwords Options

These items can be used to install a password. A Supervisor password takes precedence over a User password, and the Supervisor can limit the activities of a User. To install a password, follow these steps:

1. Highlight the item Set Supervisor/User Password on the main menu and press <Enter>.
2. The password dialog box appears.

Enter Password:

3. If you are installing a new password, type in the password. You cannot use more than eight characters or numbers. The Set Supervisor/User Password item differentiates between upper case and lower characters. Press <Enter> after you have typed in the password. If you are deleting a password that is already installed just press <Enter> when the password dialog box appears. You see a message that indicates that the password has been disabled.

**PASSWORD DISABLED !!!
Press any key to continue . . .**

4. Press any key. You are prompted to confirm the password:

Confirm Password:

5. Type the password again and press <Enter>, or just press <Enter> if you are deleting a password that is already installed.
6. If you typed the password correctly, the password will be installed.

Save & Exit Setup Option

Highlight this item and press <Enter> to save the changes that you have made in the Setup Utility and exit the Setup Utility. When the Save and Exit dialog box appears, press <Y> to save and exit, or press <N> to return to the main menu:

SAVE to CMOS and EXIT (Y/N)? **Y**

Exit Without Saving Option

Highlight this item and press <Enter> to discard any changes that you have made in the Setup Utility and exit the Setup Utility. When the Exit Without Saving dialog box appears, press <Y> to discard changes and exit, or press <N> to return to the main menu.

Quit Without Saving (Y/N)? **N**

Note: *If you have made settings that you do not want to save, use the "Exit Without Saving" item and press Y to discard any changes you have made.*

This concludes Chapter 3. Refer to the next chapter for information on the software supplied with the mainboard.

—Notes—

Chapter 4: Software

The software for this mainboard is supplied on a CD-ROM. The disk has some folders that can be used by many different mainboards, for example the **UTILITY** and **PERIPHERAL** folders. Some folders can only be used by mainboards which have certain brands of chipsets, for example the **INTEL** and **VIA** folders. In addition, software that is specifically intended for one kind of mainboard is stored in a folder with the name of that board. The folder for this mainboard is stored in the **P6VMM** folder.

Note: *Never try to install software from a folder that is not specified for use with your mainboard.*

*Before installing any software, always inspect the folder for files named **README.TXT**, **INSTALL.TXT**, or something similar. These files may contain important information that is not included in this manual.*

Folders for this Mainboard

For this board, you can install software from the following folders:

Utility Folder

You can use the software in the following sub-folders:

- AWDFLASH:** Software to erase and install new revisions of the system BIOS (CMOS)
- GAMUT:** Audio rack for built-in sound system
- MEDIARING TALK:** Telephony software.
- PC-CILLIN:** Anti-virus software
- SUPER VOICE:** Fax/modem software.

Realtek-codec Folder

You can use the software from the REALTEK-CODEC\VIA folder to install audio drivers for your operating system.

Peripheral Folder

- You can use the software from the PERIPHERAL\LAN\REALTEK folder to install LAN drivers for your operating system.

P6VMM Folder

You can use the software in the following sub-folders:

- AUDIO, IDE, LAN, and VGA:** Most of the sub-folders in this folder are empty, with a short README file giving directions to alternate folders for the appropriate software.

Auto-installing under Windows 98

The Auto-install CD-ROM makes it easy for you to install the drivers and software for your mainboard.

Note: If the Auto-install CD-ROM does not work on your system, you can still install drivers through the file manager for your OS (for example, Windows Explorer).

The support software CD-ROM disc loads automatically under Windows 98. When you insert the CD-ROM disc in the CD-ROM drive, the autorun feature will automatically bring up the install screen:

Note: The following screens are examples only. The screens and driver lists will be different according to the mainboard you are installing.

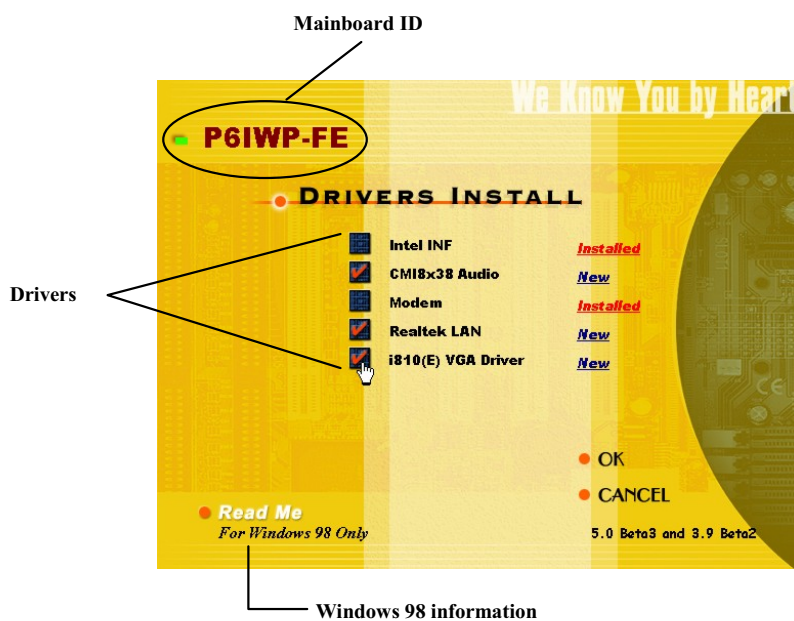

The mainboard identification is located in the upper left-hand corner. Click which drivers you want to install, and then click **OK**. Click **Cancel** if you do not want to install drivers at this time.

After clicking **OK**, the install Wizard will start.

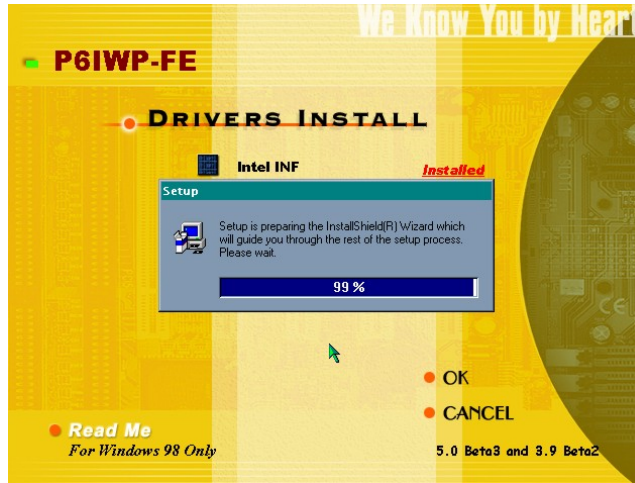

A driver installation screen appears:

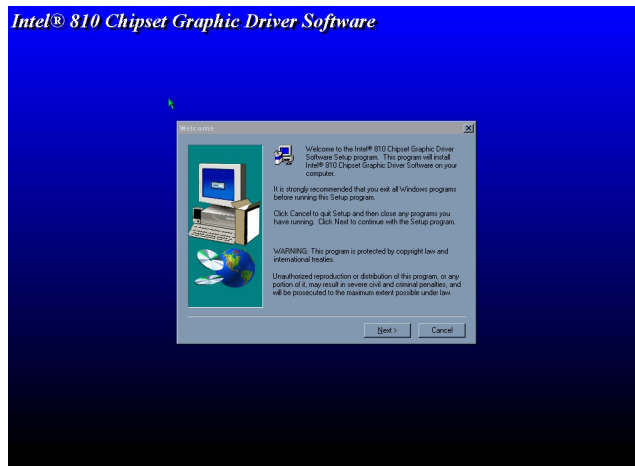

Follow the instructions on the screen to install the driver.

Software is automatically installed in sequence. You will need to follow the onscreen instructions, confirm commands and allow the computer to restart a few times to complete installing whatever software you selected to install:



When the process is finished, all the support software will be installed and working.

After you finish installing the drivers for your mainboard, the Applications screen appears:

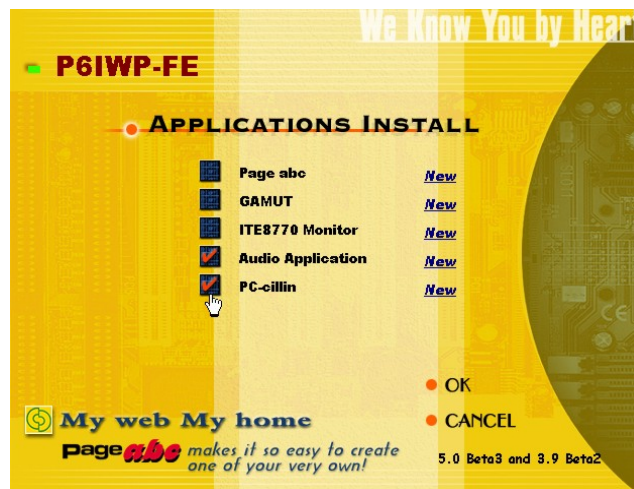

Select which applications you want to install, and click **OK**. If the auto-installed driver cannot be installed completely, you can still use your operating system's file manager (for example Windows Explorer) to install all the drivers manually.

If the mainboard doesn't support the autoinstall feature, you will see the following screen:



Note: If the opening screen doesn't appear, double-click the file "autorun.exe" in the \AUTORUN directory.

Click READ ME to read the latest installation instructions. Click BROWSE THE CD TITLE to open Windows Explorer and show the contents of the support CD.

Double-click a folder to display the sub-folders. Before installing the software, look for a file named README.TXT, INSTALL.TXT or something similar. This file may contain important information to help you install the software correctly.

Some software is installed in separate folders for different operating systems, such as DOS, WIN NT, or WIN98/95. Always go to the correct folder for the kind of OS you are using.

To install the software, execute a file named SETUP.EXE or INSTALL.EXE by double-clicking the file and then following the instructions on the screen.

Note: Enable Windows Explorer to display file extensions (for example, EXE).

Utility Folder Installation Notes

Award Flash Memory Utility

This utility lets you erase the system BIOS stored on a Flash Memory chip on the mainboard, and lets you copy an updated BIOS to the chip. Take care how you use this program. If you erase the current BIOS and fail to write a new BIOS, or write a new BIOS that is incorrect, your system will malfunction.

There are three flash memory utilities called **AWD66.EXE**, **AWD77.EXE**, and **AWD772.EXE**. For this mainboard, you must use the **AWD772.EXE** utility. To use the utility, you must be in real-mode DOS (not the DOS box that is available in Windows 95/98/NT). If you are using WINDOWS 95/98, shut down your computer and select the option Restart in DOS in the shut-down dialog box. If you are running Windows NT, shut down your computer and boot from a DOS diskette temporarily in order to run the flash memory utility.

PC-cillin Software

The PC-cillin software program provides anti-virus protection for your system. This program is available for:

- DOS – \UTILITY\PC-CILLIN\DOS\PCSCAN.EXE
- Win98 – \UTILITY\PC-CILLIN\WIN98\SETUP.EXE

Anti-virus software is provided for DOS and WIN95/98. Browse to the appropriate directory for your operating system. For DOS, copy all the files in the DOS folder to your hard disk drive and run PSCAN to scan your system. For Windows 95/98, run SETUP to install the application software.

GAMUT

The Gamut audio rack software for the built-in sound system is provided for different languages. Go to the directory \UTILITY\GAMUT and choose either the English or Chinese subdirectory; then run SETUP.EXE to install the application software.

MediaRing Talk

To install the MediaRing Talk voice modem software for the built-in modem, go to the directory \UTILITY\MEDIARING TALK; then run MRTALK-SETUP7.2.EXE to install the application software.

Super Voice

To install the Super Voice voice, fax, data communication application for use with the built-in fax/modem, go the directory \UTILITY\SUPERVOICE; then run PICSHELL.EXE to install the application software.

Realtek-codec Folder Installation Notes

This folder has software and drivers for the Realtek codec sound system that is integrated on this mainboard. The Realtek codec allows the system to generate optimal sound effects. Drivers are provided for DOS, Linux, and Windows 2000/98/9x/NT.

Windows Installation

Use the SETUP.EXE application in the \REALTEK-CODEC\WIA folder.

DOS Installation

Browse to the \REALTEK-CODEC\WIA\DOS folder and run INSTALL.EXE.

Linux Installation

Refer to your operating system handbook for instructions on installing Linux drivers.

Peripheral Folder Installation Notes

This folder has software and drivers for the Realtek LAN chip that is integrated on this mainboard. Browse to \PERIPHERAL\LAN\REALTEK folder and launch the HELP8139.EXE application to guide you through the Realtek LAN software installation process.

Mainboard (P6VMM) Installation Notes

Most of the sub-folders in this folder are empty, with a short README file giving directions to alternate folders for the appropriate software.

Appendix: Jumper Setting Reference

Quick Jumper Setting Reference

If you are familiar with most of the material in this chapter, you can begin preparing the mainboard for installation by using this quick reference to begin setting the jumpers.

JP1: Clear CMOS jumper

Use this jumper to clear the contents of the CMOS memory.

Function	Jumper Setting
Normal operation	Short pins 1-2
Clear CMOS	Short pins 2-3



JP2: Keyboard Power On/Off jumper

Use this jumper to enable the keyboard to power on the computer. You must also enable this function in the BIOS Setup Utility. Refer to Chapter 3.

Function	Jumper Setting
Disable	Short pins 1-2
Enable	Short pins 2-3

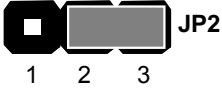

JP5: Suspend to RAM support enable/disable jumper

Use this jumper to enable or disable the Suspend to RAM (STR) Function. You must also enable this function in the BIOS Setup Utility. Refer to Chapter 3.

Function	Jumper Setting
Enable	Short pins 1-2
Disable	Short pins 2-3



JP6: USB wake up jumper

Use this jumper to enable a signal to the USB ports (located on the I/O port panel) to wake up the system from power saving mode.

Function	Jumper Setting
Disable	Short pins 1-2
Enable	Short pins 2-3



JP7: CPU frequency select jumper

Use this jumper to force a CPU that has a 66 MHz frontside bus (FSB) to run at a 100 MHz FSB speed.

Function	Jumper Setting
Normal operation	Short pins 1-2
Force a 66 MHz FSB to run at 100 MHz FSB	Short pins 2-3



Note: The CPU speed is determined by the CPU Host/PCI Clock speed multiplied by the CPU Clock Ratio. Refer to the Frequency Control Option in Chapter 3 for more information.

Forcing the CPU to run at a higher clock speed than it was rated for is called overlocking and is not recommended.

JP8: CPU frequency select jumper

Use this jumper to force a CPU that has a 100 MHz frontside bus (FSB) to run at a 133 MHz FSB speed.

Function	Jumper Setting
Normal operation	Short pins 1-2
Force a 100 MHz FSB to run at 133 MHz FSB	Short pins 2-3



Note: The CPU speed is determined by the CPU Host/PCI Clock speed multiplied by the CPU Clock Ratio. Refer to the Frequency Control Option in Chapter 3 for more information.

Forcing the CPU to run at a higher clock speed than it was rated for is called overlocking and is not recommended.

JP11, JP12, JP13: Flat Panel/TV select jumpers

Use these jumpers to select a flat panel or TV display when using the LT11 riser.

Function	Jumper Setting
Flat Panel	Short JP11/12/13 pins 1-2
TV	Short JP11/12/13 pins 2-3

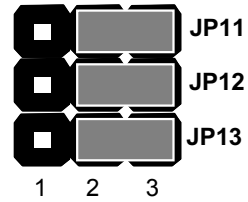

JP14: Onboard CODEC/AMR slot select jumper

Use this jumper to enable either the onboard codec or the AMR slot (AMR1).

Function	Jumper Setting
Onboard codec	Short pins 1-2
AMR slot	Short pins 2-3



JP16: Dual color LED header

This header allows the user to install red and green LED indicators to indicate when the computer is in Suspend to RAM (STR) or normal. Although the values are not predefined, red usually indicates STR and green indicates normal.

JP17: USB2 wake up jumper

Use this jumper to enable a signal to the USB devices 3 and 4 (located on the front panel) to wake up the system from power saving mode.

Function	Jumper Setting
Disable	Short pins 1-2
Enable	Short pins 2-3



JP18: BIOS Flash protect jumper

Use this jumper to enable or disable the BIOS flash protection on the mainboard. You should disable this jumper when you want to flash the BIOS.

Function	Jumper Setting
Disable	Short pins 1-2
Enable	Short pins 2-3



JP19: AMR codec mode

Use this jumper to define the AMR codec mode to avoid conflict with the onboard AC 97 codec.

Function	Jumper Setting
Slave AMR card	Short pins 1-2
Master AMR card	Short pins 2-3



PANEL1: Panel connectors for switches and indicators

Use the panel connector to implement the switches and indicators on your system case.

Panel connectors for switches and indicators

Function	Pins
Speaker	1, 3, 5, 7
Power LED Indicator	+2, 4, 6
Green LED Indicator	+13, 14
Hard Disk LED Indicator	+15, 16
Reset Switch	17, 18
Sleep Switch (SMI) Indicator	+19, 20
Power ON/OFF	21, 22

