

Important Information

Copyright

This publication, including all photographs, illustrations and software, is protected under international copyright laws, with all rights reserved. Neither this manual, nor any of the material contained herein, may be reproduced without the express written consent of the manufacturer.

Disclaimer

The information in this document is subject to change without notice. The manufacturer makes no representations or warranties with respect to the contents hereof and specifically disclaims any implied warranties of merchantability or fitness for any particular purpose. Further, the manufacturer reserves the right to revise this publication and to make changes from time to time in the content hereof without obligation of the manufacturer to notify any person of such revision or changes.

Trademark Recognition

Microsoft, MS-DOS and Windows are registered trademarks of Microsoft Corp.
MMX, Pentium, Pentium-II, Celeron are a registered trademarks of Intel Corporation.
VGA, OS/2, PS/2 are registered trademarks of International Business Machines.
AMD, K5, K6 are registered trademarks of Advanced Micro Devices Inc.
Cyrix, M1 are registered trademarks of Cyrix Corporation.
Other product names used in this manual are the properties of their respective owners and are acknowledged.

Version 1.0

Safety Compliance

Federal Communications Commission (FCC)

This equipment has been tested and found to comply with the limits for a Class B digital device, pursuant to Part 15 of the FCC Rules. These limits are designed to provide reasonable protection against harmful interference in a residential installation. This equipment generates, uses, and can radiate radio frequency energy and, if not installed and used in accordance with the instructions, may cause harmful interference to radio communications. However there is no guarantee that interference will not occur in a particular installation. If this equipment does cause harmful interference to radio or television reception, which can be determined by turning the equipment off and on, the user is encouraged to try to correct the interference by one or more of the following measures:

- Reorient or relocate the receiving antenna.

- Increase the separation between the equipment and the receiver.

- Connect the equipment onto an outlet on a circuit different from that to which the receiver is connected.

- Consult the dealer or an experienced radio/TV technician for help.

Shielded interconnect cables and shielded AC power cable must be employed with this equipment to insure compliance with the pertinent RF emission limits governing this device. Changes or modifications not expressly approved by the system's manufacturer could void the user's authority to operate the equipment.

Declaration of Conformity

This device complies with part 15 of the FCC rules. Operation is subject to the following conditions:

- This device may not cause harmful interference, and

- This device must accept any interference received, including interference that may cause undesired operation.

Canadian Department of Communications

This class B digital apparatus meets all requirements of the Canadian Interference-causing Equipment Regulations.

Cet appareil numérique de la classe B respecte toutes les exigences du Règlement sur le matériel brouilleur du Canada.

Table of Contents

Chapter 1: Introduction

Welcome	1
About the Manual	1
Checklist.....	2
Features.....	2

Chapter 2: Installation

Before You Begin	5
Mainboard Guide	6
Preparing the Mainboard	7
Install the Mainboard in the System Case	12

Chapter 3: Setup

About the Setup Utility	17
Standard CMOS Setup Option	19
BIOS Feature Setup Option	20
Chipset Features Option	22
Power Management Setup Option	24
PNP/PCI Configuration Option	27
Load BIOS Defaults Option.....	28
Load Optimum Settings Option	28
Integrated Peripherals Option ...	28
Password Settings	31
IDE HDD Auto Detection Option	31
Save and Exit Setup Option.....	31
Exit Without Saving Option	31

Chapter 4: Software

About the Software	32
Utility Folder Installation Guide..	32
Utility Installation Notes...	33
Mainboard Folder Installation Guide...	34
Mainboard Installation Notes.....	34
CMI8338 Audio Folder Installation Guide	35

Appendix

1. Quick Jumper Setting Reference....	37
---------------------------------------	----

Chapter 1: Introduction

Welcome

Congratulations on your purchase of the P6EXP-Me mainboard. The P6EXP-Me mainboard is a micro-ATX board measuring 243.8 mm by 200 mm and using a 4-layer printed circuit board. This board features a PGA370 ZIF (Zero Insertion Force) processor socket. This socket can be installed with the latest generation of Intel Celeron processors that are packaged in a Plastic Pin Grid Array (PPGA), just like the original Pentium processors. The mainboard supports a system bus of 66 MHz that permits the use of inexpensive 66 MHz memory chips. Three DIMM sockets are provided for a maximum memory capacity of 256 MB. The mainboard has an integrated 3D-sound system, and the Intel chipset supports an AGP graphics card. Three PCI slots and one ISA slot are provided for system expansion.

This chapter contains the following information:

- **About the Manual** explains how the information in this manual is organized
- **Checklist** comprises a list of the standard and optional components that are shipped with this mainboard,
- **Features** highlights the functions and components that make this one of the best value mainboards on the market

About the Manual

The manual consists of the following chapters:

Introduction

Use the **Introduction** Chapter to learn about the features of the mainboard, and the checklist of items that are shipped with the package.

Installation

Use the **Installation** Chapter to learn how to install the mainboard and get your system up and running.

Setup

Use the **Setup** Chapter to configure the mainboard for optimum performance.

Software

Use the **Software** Chapter to learn how to use the software drivers and support programs that are provided with this mainboard.

Checklist

Compare the contents of your mainboard package with the standard checklist below. If any item is missing or appears damaged, please contact the vendor of your mainboard package.

Standard Items

- ✓ 1 x P6EXP-Me Mainboard
- ✓ 1 x Cable/Bracket Pack
 - Diskette drive ribbon cable
 - IDE drive ribbon cable
- ✓ This User's Manual
- ✓ Software Support CD-ROM Disc

Features

This is an economic platform which provides entry-level through to business-class Pentium-II performance for minimum cost. This is a powerful platform that leverages the low-cost/high-performance features of the new generation of Celeron processors.

Low-cost/high performance Processing

Intel's new generation of Celeron processors are shipped in the familiar PPGA square plastic package that are common to all Pentium and Pentium-compatible processors. The mainboard has a PGA370 ZIF socket for the installation of the Celeron. (*Note that the socket has a different pinout than Pentium/Pentium compatibles and cannot be used by Socket-7 processors.*) The Celeron processor features Pentium-II performance with internal clock speeds of 300, 333, 366, 400, and 433 MHz (higher speeds may be forthcoming), 32K of level-1 cache memory, and 128K of level-2 cache memory. The Celeron is an economic processor because it runs on a 66 MHz system bus so that the mainboard design and components are not high-cost items. This mainboard allows entry-level and business-class users to move up to Pentium-II performance at minimum cost. Configuration for different processor speeds is automatically set by firmware and motherboard switch or jumper settings are not required.

Inexpensive Memory

The board has three DIMM sockets for the installation of 168-pin, 3.3V non-buffered DIMM memory modules. The DIMM memory modules can be installed with EDO or SDRAM memory chips. The board supports a memory bus of 66 MHz, so inexpensive 66 MHz memory chips can be used. Each installed memory module can be populated

with 16 MB up to 128 MB of memory, and can be single-sided or double sided. However, total installed memory must not exceed 256 MB. If you install a double-sided module in either DIMM 2 or DIMM 3, you cannot install any memory module in the other socket. DIMM1 is independent and does not have this limitation.

Highly Integrated Design

This mainboard features a high level of integrated functions provided by the onboard chipsets. The Intel 82443EX provides all the north bridge support – CPU and memory addressing, PCI-IDE controller, and PCI-bus interface. In addition, the 82443EX provides a complete AGP graphics controller solution. The Intel 82371EB provides the south bridge support – ACPI power management, real-time clock, and USB interface. The Winbond W83977EF is a single chip I/O solution, and the Elite PCI Audio-CMI8338 provides the onboard 3D audio feature. Hardware monitoring is supported by the GL520SM. This highly integrated mainboard ensures stability and allows a fully functional system to be created by adding just a processor, a graphics adapter and memory.

Built-in PCI 3D Sound

The Elite PCI Audio-CMI8338 is a single chip solution for PCI-bus 3D audio. The chip provides Sound Blaster 16-bit-compatible audio, plus support for Microsoft's DirectSound 3D specification and Aureal A3D interface. The sound ports include jacks for speakers, microphone and stereo in, and a game/MIDI port. The audio system supports full duplex operation and drivers are available for WIN 95/98 and WIN NT 4.0. The audio system can output sound to 4 speakers and also supports SPDIF 24-bit digital sound input and output.

Solid Expansion Options

Because this is a highly integrated board with built-in audio and a full set of I/O ports, it does not require a full set of expansion slots. The board provides three usable slots. The board has three 32-bit PCI slots and one 8/16-bit ISA slot. The ISA slot is shared with one of the PCI slots meaning that you can use either the ISA slot or the PCI slot, but not both at the same time. PCI1 and PCI3 share a request line. This means that only one of these slots can support a bus-mastering PCI expansion card.

Integrated I/O

Using the Winbond W83977EF I/O chip and the Intel 82443EX/82371EB chipset, the board has a comprehensive set of integrated I/O ports. The I/O port array features PS/2 keyboard and mouse ports, a parallel port, two USB ports, two serial ports, a game/MIDI port, and three audio jacks. Optionally, you can use the built-in mainboard header to add in an infrared port. The mainboard has two PCI-IDE channels and a floppy disk drive interface.

Hardware Monitoring

This mainboard features hardware monitoring supported by the GL520SM system monitor chip. Using the system BIOS, system administrators can track critical hardware parameters such as CPU temperature and cooling fan speeds. Limits can be set to ensure system power management prevents threshold temperatures and parameters from being exceeded.

Keyboard Power On Feature

Using the system BIOS setup program, you can configure the system to turn on using keyboard hot keys and mouse, or a keyboard typed password. A green keyboard is not required.

Programmable Firmware

The mainboard includes Award BIOS which allows BIOS setting of CPU parameters. The fully programmable firmware enhances the system features and allows users to set power management, CPU and memory timing, LAN and modem wake-up alarms, and so on. The firmware can also be used to set parameters for different Celeron processor clock speeds so that you don't need to change mainboard jumpers and switches.

Chapter 2: Installation

Before You Begin

Before you begin to install your P6EXP-Me mainboard, take some precautions to ensure that you avoid the possibility of damage to the product from static electricity. Ensure too that you are installing the mainboard into a suitable case.

Static Electricity

In adverse conditions, static electricity can accumulate and discharge through the integrated circuits and silicon chips on this product. These circuits and chips are sensitive and can be permanently damaged by static discharge.

If possible wear a grounding wrist strap clipped to a safely grounded device during the installation.

If you don't have a wrist strap, discharge any static by touching the metal case of a safely grounded device before beginning the installation.

Leave all components inside their static-proof bags until they are required for the installation procedure.

Handle all circuit boards and electronic components carefully. Hold boards by the edges only. Do not flex or stress circuit boards.

Choosing a Case

The P6EXP-Me mainboard complies with the specifications for a micro-ATX board. The micro-ATX format features small size, fewer expansion slots and smaller power consumption, so that the system case is less expensive. You can also install this kind of board into a full-size ATX case.

Some features on the mainboard are implemented by cabling connectors on the mainboard to indicators and switches on the system case. Ensure that your case supports all the features required. The P6EXP-Me mainboard can support one or two floppy diskette drives and four enhanced IDE drives. Ensure that your case has sufficient power and space for all the drives that you intend to install.

The mainboard has a set of I/O ports on the rear edge. Ensure that your case has an I/O template that supports the I/O ports and expansion slots.

Mainboard Guide

Use the following illustration and key to identify the components on your mainboard.

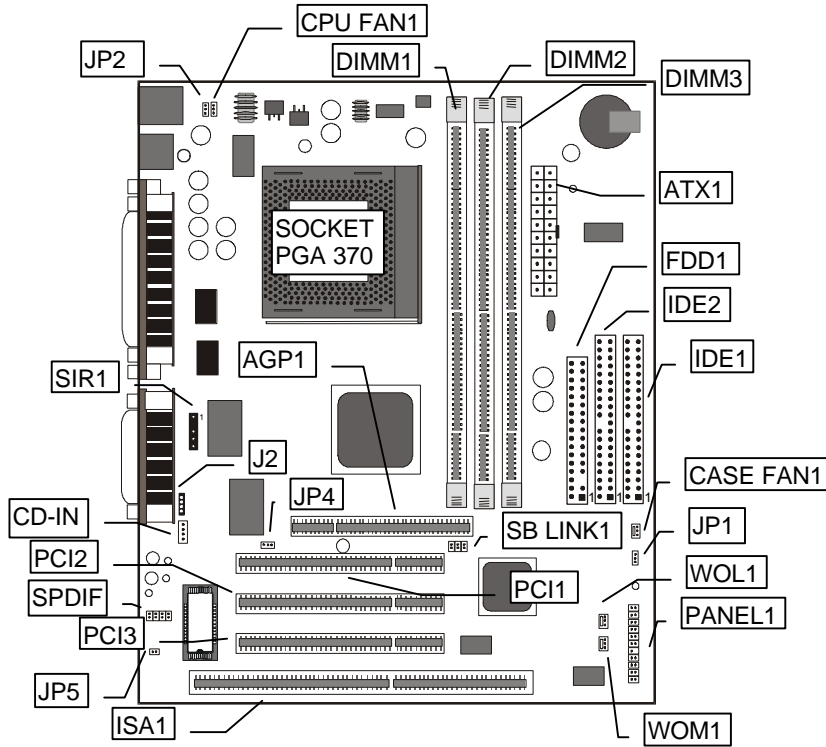

Key to Mainboard Components

Component	Description
ISA1	1 x 8/16-bit ISA expansion slots
PCI 1,2,3	3 x 32-bit PCI expansion slots
AGP1	Slot for AGP graphics adapter
SOCKET PGA 370	Processor socket for Celeron processor
DIMM1, DIMM2, DIMM3	Slots for 168-pin memory modules
FDD1	Connector for floppy disk drives
IDE1, IDE2	Primary and secondary IDE channels
ATX1	Connector for ATX power supply
SIR1	Connector for optional infrared port
PANEL1	Panel connector for switches and indicators
CPU FAN1	Power connector for CPU cooling fan
CASE FAN1	Power connector for case cooling fan

WOM1	Connector for modem wake up
WOL1	Connector for LAN wake up
SPDIF	SPDIF In/out connector (professional 24-bit digital audio interface)
SB LINK1	SB-Link connector for optional PCI Sound Blaster audio card
CD-IN	Audio connector for optional CD-ROM drive
JP1	Clear CMOS memory jumper
JP2	Keyboard power on jumper
JP4	Audio enable/disable jumper
JP5	Set SPDIF output signal level jumper
J2	Auxiliary audio connector for optional CD-ROM drive

Side View of the Input/Output Ports

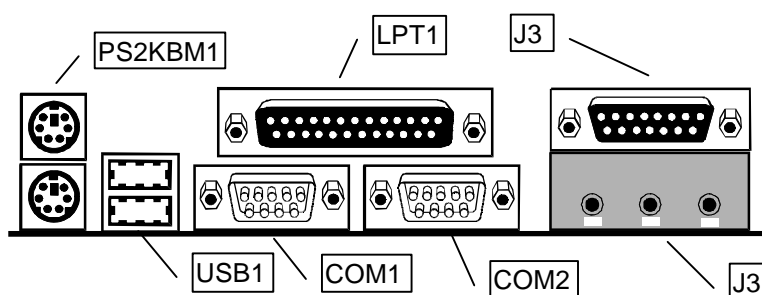

Component	Description
PS2KBM1	PS/2 port for pointing device (upper port)
	PS/2 port for keyboard (lower port)
LPT1	External parallel port
J3 (Upper)	External game/MIDI port
J3 (Lower)	Audio jacks for (from left to right) line out, line in, microphone
COM2	External serial port 2/4
COM1	External serial port 1/3
USB1	Two stacked Universal Serial Bus ports

Preparing the Mainboard

Prepare the main board by installing the Celeron Pentium-II processor and then installing either 1, 2 or 3 memory modules. This board supports the new generation Celeron processor that is packaged in a Plastic Pin Grid Array (PPGA) designed to fit the PGA370 ZIF socket on the mainboard. You can use a Celeron that runs at either 300, 333, 366, 400 or 433 MHz. Next, install one or more memory modules. Finally, review all the important jumper settings to ensure that the board is configured correctly.

Install the Processor

This mainboard is installed with a PGA370 ZIF processor socket. This socket will only support the PPGA Celeron processor. **Do not try to insert a socket-7 processor such as a Pentium or Pentium-compatible processor.** The Celeron processors all run over a 66 MHz system bus and have internal clock speeds ranging from 300 to 400 MHz. Configuration of the processor is made automatically using the mainboard BIOS (see the Setup chapter).

Follow the steps below to install the Celeron processor in the PGA370 socket.

1. Locate the zero insertion force (ZIF) PGA370 socket for the processor.

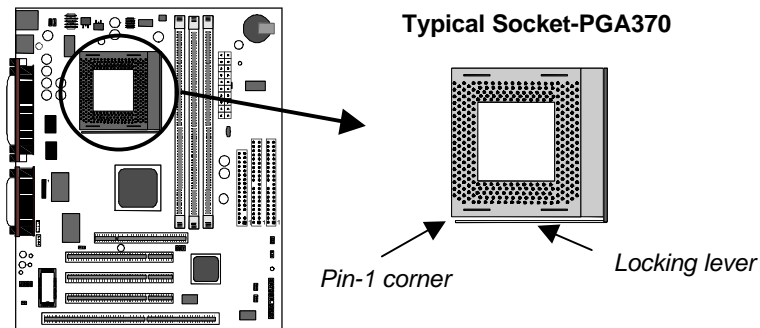

2. On the socket and on the processor, identify the pin 1 corner. You can identify the pin 1 corner by noting that in the rectangular matrix of holes on the socket, one hole is absent on two corners. The front corner with the absent hole is the pin-1 corner. On the processor, the pin-1 corner is beveled. (see the illustration below).
3. Push the socket locking lever away from the socket to unhook it. Swing the lever into the upright position.
4. Insert the processor into the socket taking care that you have matched the pin 1 corners. No force is required, and the processor should seat smoothly into the socket.

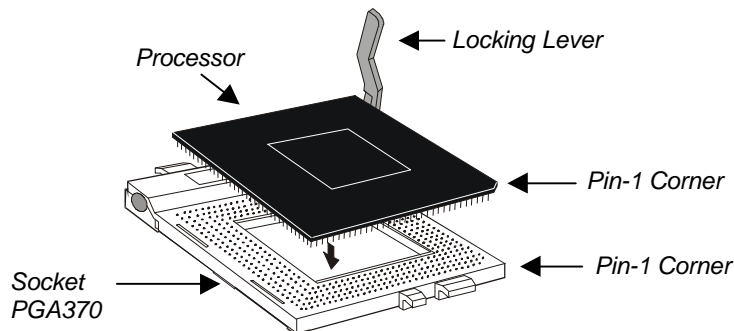

5. Swing the locking lever down and hook it under the latch on the side of the socket to lock it in place.
6. Locate the power connector for the processor cooling fan CPU FAN1. If your processor has a cooling fan installed, connect the cable from the cooling fan to CPU FAN1.

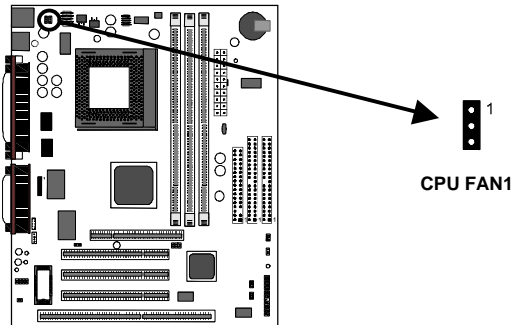

Install the Memory Modules

For this mainboard, you must use 168-pin 3.3V non-buffered Dual In-line Memory Modules (DIMMs). The memory chips can be EDO RAM or SDRAM. The memory bus runs at 66 MHz so you need not use PC-100 memory modules. You can use memory modules that have a capacity of 16 MB up to 128 MB. Total installed memory must not exceed 256 MB.

You can use memory modules which have memory chips on just one side (single-sided) or memory chips on both sides (double-sided). If you install a double-sided module in either DIMM 2 or 3, you must leave the other socket empty. DIMM1 is independent and does not have this limitation.

1. Locate the DIMM sockets on the mainboard.

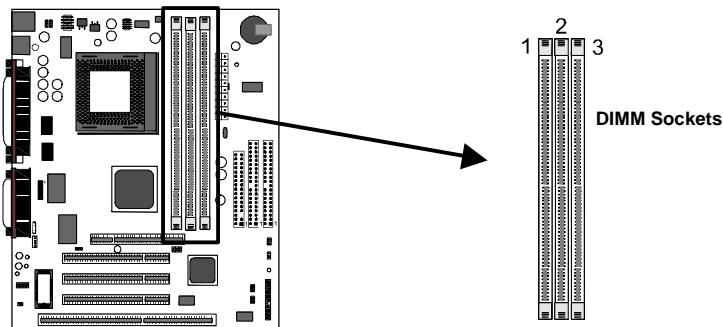

2. The DIMM sockets are keyed with notches and the DIMMs are keyed with cut-outs so that they can only be installed correctly. Check that the cut-outs on the DIMM module edge connector matches the notches in the DIMM socket.
3. Push the latches on each side of the DIMM socket down.
4. Install the DIMM module into the socket and press it carefully but firmly down so that it seats correctly. The latches at either side of the socket will be levered upwards and latch on the edges of the DIMM when it is installed correctly.

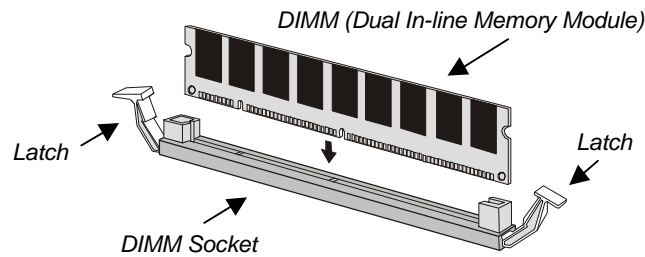

Check all the Jumper Settings

Check all the mainboard jumpers to ensure that the board is configured correctly.

A Note on Jumpers

*A jumper consists of two or more pins mounted on the mainboard. Some jumpers might be arranged in a series with each pair of pins numbered differently. Jumpers are used to change the electronic circuits on the mainboard. When a jumper cap is placed on two jumper pins, the pins are **SHORT**. If the jumper cap is removed (or placed on just a single pin) the pins are **OPEN**.*

JP1: Clear CMOS Memory Jumper

This jumper lets you erase the system setup settings that are stored in CMOS memory. You might need to erase this data if incorrect settings are preventing your system from operating. To clear the CMOS memory, turn off the system, disconnect the power cable from the mainboard, and short the appropriate pins for a few seconds.

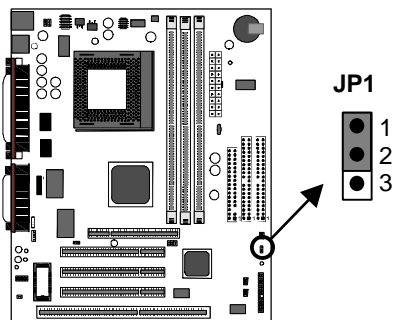

Function	Jumper Cap
Normal operation	Short pins 1-2
Clear CMOS	Short pins 2-3

JP2: Keyboard Power On Jumper

This jumper lets you use a typed-in password as a power switch to turn your system on. If you enable this property, you need to define the password or the hot keys using the setup utility. See Chapter 3 for more information.

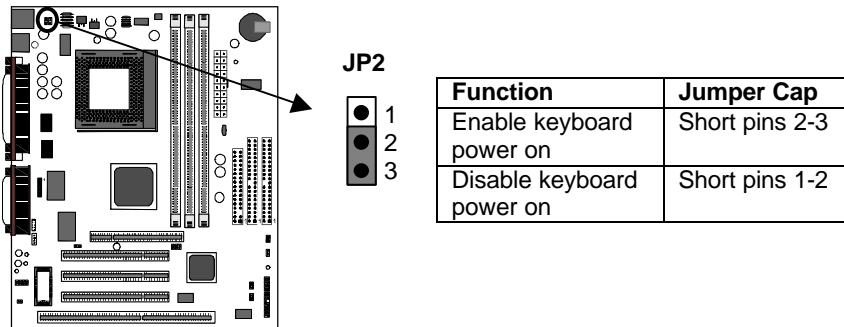

JP4: Audio System Enable/disable Jumper

This jumper lets you enable or disable the audio system that is integrated on the mainboard. You must disable the audio system if you install an alternative sound card using one of the expansion slots.

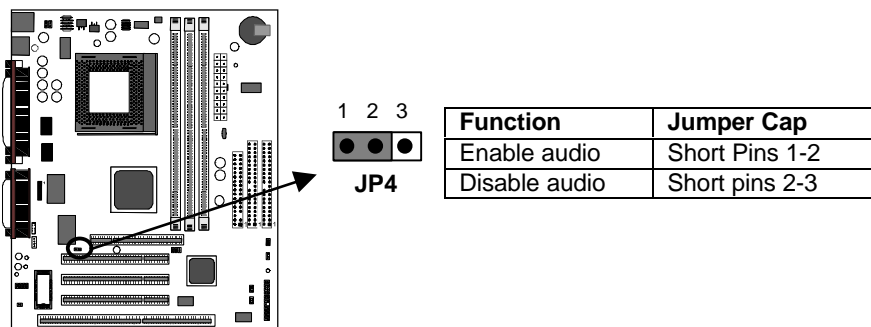

JP5: Set SPDIF Output Signal Level Jumper

If you use the SPDIF Input/Output connector (SPDIF), you can use this jumper to set the level of the output signal to either 5 volts or 0.5 volts.

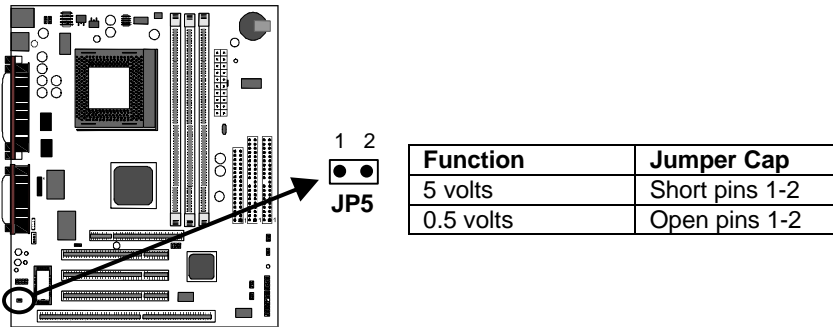

Install the Mainboard in the System Case

Use the screws and mounting brackets supplied with your system case to install the mainboard. Follow the instructions provided by the case manufacturer.

Connect Devices, Switches and Indicators to the Mainboard

Note: You might not need to carry out every step in the following procedure. It depends on the options you are installing, and the features that are supported by your system case.

Note: Ribbon cable connectors are usually keyed so that they can only be installed correctly on the device connector. If the connector is not keyed make sure that you match the pin-1 side of the cable connector with the pin-1 side of the device connector. Each connector has the pin-1 side clearly marked. The pin-1 side of each ribbon cable is always marked with a red stripe on the cable.

Part One – Internal Connections

1. Locate the floppy diskette drive connector FDD1. Use the ribbon cable to connect one or two floppy diskettes to the mainboard.
2. Locate the Enhanced IDE connectors IDE1 (primary) and IDE2 (secondary). A single IDE cable is provided with the mainboard. Connect the cable to IDE1. The cable has two connectors for IDE devices. If you connect two devices, you must configure one device as Master, and one device as Slave. See the documentation provided with the devices for information on this. To install more drives, use another IDE cable and connect one or two devices to IDE2.

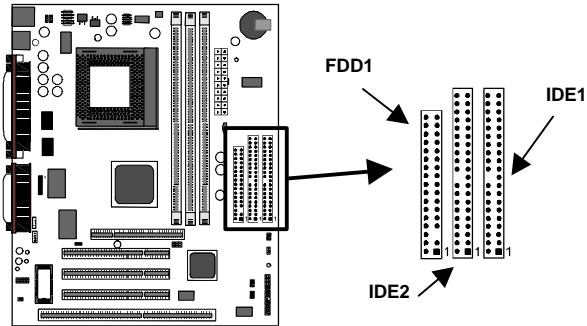

3. Locate the power connector ATX1. Connect the power cable from the power supply unit to ATX1. The connector is keyed so that it can only be installed correctly.
4. If your system case has a built-in cooling fan, you can supply power to the fan from the case fan power connector CASE FAN1. Connect the power cable from the fan to CASE FAN1.
5. If you want to install an optional Serial Infrared Port, connect the cable from the optional IR port to the SIR1 connector on the mainboard.

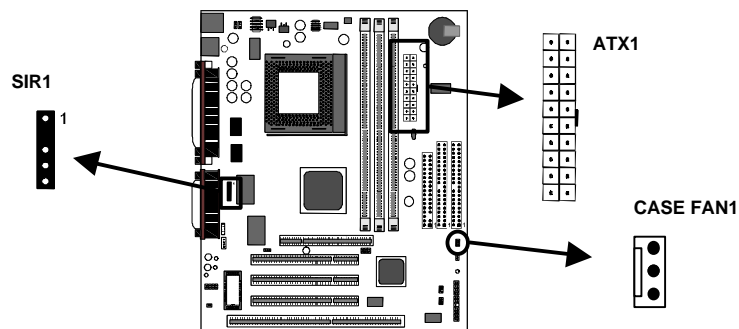

***Note:** If you install an optional infrared port, it requires resources that are normally used by the external serial port COM2, so you cannot use the infrared port and COM2 at the same time. You can use the setup utility to activate the infrared port or the COM2 serial port. See Chapter 3 for more information.*

- Locate the bank of switch and indicator connectors PANEL1. These connectors provide control functions to your system case. Use the table below to make the connections.

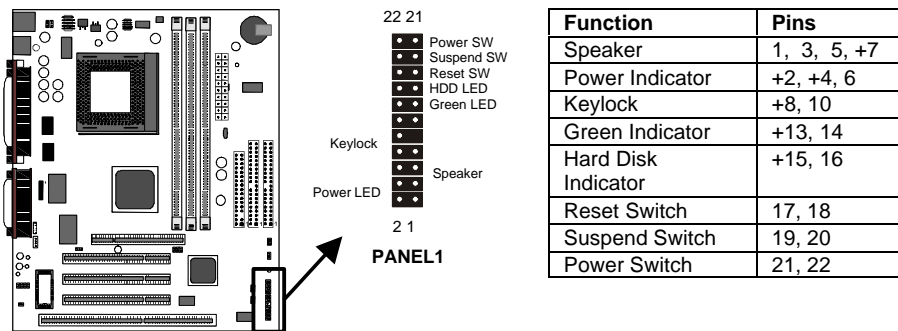

- The mainboard has wake up connectors for an optional network adapter or an optional internal fax/modem card. If you have installed a network adapter expansion card, connect it to the wake on LAN connector WOL1. If you have installed an internal fax/modem expansion card, connect it to the wake on modem connector WOM1.

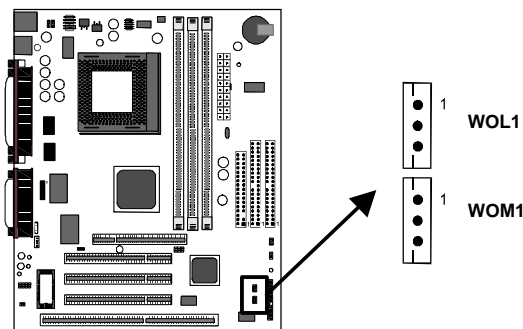

- The mainboard has four audio connectors. CD-IN is a 4-pin audio connector which can be used to input the audio from a CD-ROM or DVD drive. J2 is exactly the same, except that it supports an alternative kind of connector. Use either CD-IN or J2 to connect your CD/DVD drive audio output. If you have installed a device which supports SPDIF digital audio, you can connect the device to the SPDIF output connector SPDIF. If you disable the built-in audio and install a Sound Blaster PCI sound card, you can connect it to the SB-Link connector SB LINK1. SB-Link allows a PCI Sound Blaster card to function correctly while playing DOS real-mode games.

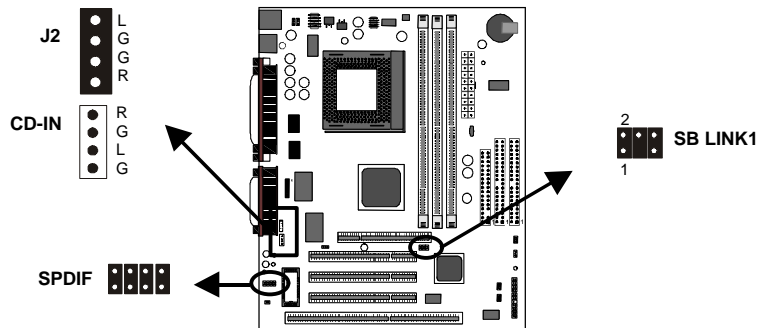

9. Locate the three 32-bit PCI expansion slots, the 8/16 bit ISA expansion slot, and the AGP graphics adapter slot. Install optional 32-bit PCI cards into the PCI slots. Install an optional 8/16-bit card into the ISA slot. The ISA slot is shared with the the PCI3 slot just above it. This means that you can only use one of these slots, but not both together. If you have a graphics adapter which has an AGP edge connector, install it in the AGP slot. Secure all cards by screwing the card brackets to the slot openings in the system case.

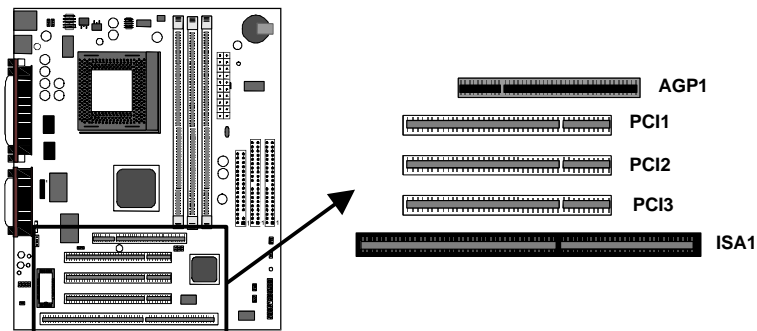

Part Two – External Connections

After you have installed the mainboard and completed the internal connections, you can use the external connectors to attach peripheral devices to your system.

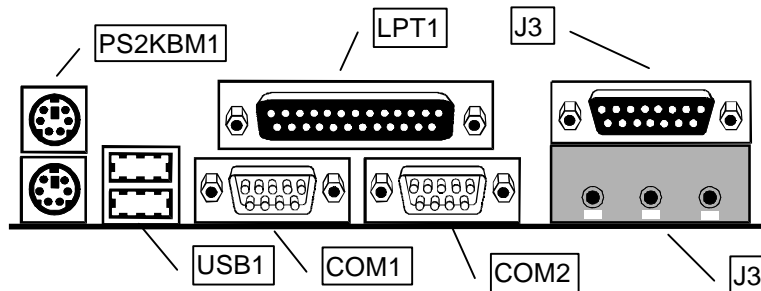

1. PS2KBM1 is a stack of two PS/2 mini-DIN ports. The upper port can be used by a PS/2 mouse or pointing device. The lower port can be used by a PS/2 keyboard.
2. LPT1 is a parallel port that can be used by printers or other parallel communications devices. The system identifies the parallel port as LPT1.
3. The upper 15-pin port J3 is a game/MIDI port. You can use this port to connect a joystick or a MIDI device to your system.
4. The lower part of J3 is three audio jacks. The left side jack is for a stereo line out signal. The middle jack is for a stereo line in signal. The right side jack is for a microphone.
5. COM2 is a serial port that can be used by serial devices such as a mouse, a fax/modem and so on. This serial port is identified by the system as COM2/4.
6. COM1 is a serial port that can be used by serial devices such as a mouse, a fax/modem and so on. This serial port is identified by the system as COM1/3.
7. USB1 is a stack of two Universal Serial Bus ports. Use these ports to connect to USB devices.

Chapter 3: Setup

About the Setup Utility

This chapter explains how to use and modify the BIOS setup utility that is stored on the mainboard. The setup utility stores information about the mainboard components, and the configuration of other devices that are connected to it. The system uses this information to test and initialize components when it is started up, and to make sure everything runs properly when the system is operating.

The setup utility is installed with a set of default values. The default values are designed to ensure that the system will operate adequately. You will probably have to make changes to the setup utility whenever you add new components to your system such as new disk drives. You may be able to generate increased performance by changing some of the timing values in the setup, but this can be limited by the kind of hardware you are using, for example the rating of your memory chips. In certain circumstances, the system may generate an error message which asks you to make changes to the setup utility. This happens when the system finds an error during the POST (power on self test) that it carries out at start up.

Starting the Setup Utility

You can only start the setup utility shortly after the computer has been turned on. A prompt appears on the computer display which says “*Press DEL to run Setup*”. When you see this prompt, press the **Delete** key, and the system will start the setup utility and display the main menu of the utility.

Using the Setup Utility

When you press the **Delete** key to start setup, the main menu of the utility appears.

The main menu of the setup utility shows a list of the options that are available in the utility. A highlight shows which option is currently selected. You can use the cursor arrow keys to move the highlight to other options. When an option is highlighted, you can execute the option by pressing the **Enter** key.

Some options lead to dialog boxes which ask you verify that that you wish to execute that option. You usually answer these dialogs by typing **Y** for yes and **N** for no.

Some options lead to dialog boxes which ask for more information. Setting the User Password or Supervisor Password have this kind of dialog box.

ROM PCI/ISA BIOS (P6EXP-Me)
 CMOS SETUP UTILITY
 AWARD SOFTWARE, INC.

STANDARD CMOS SETUP	INTEGRATED PERIPHERALS
BIOS FEATURES SETUP	SUPERVISOR PASSWORD
CHIPSET FEATURES SETUP	USER PASSWORD
POWER MANAGEMENT SETUP	IDE HDD AUTO DETECTION
PNP/PCI CONFIGURATION	SAVE & EXIT SETUP
LOAD BIOS DEFAULTS	EXIT WITHOUT SAVING
LOAD OPTIMUM SETTINGS	
Esc : Quit	↑ ↓ → ← : Select Item
F10 : Save & Exit Setup	(Shift)F2 : Change Color

Some options lead to tables of items. These items usually have a value on the right side. The value of the first item is highlighted, and you can use the cursor arrow keys to select any of the other values in the table of items. When an item is highlighted, you can change the value by pressing the **PageUp** or **PageDown** keys, or the **Plus** or **Minus** keys. The **PageUp** and **Plus** keys cycle forward through the available values, the **PageDown** and **Minus** keys cycle backwards through the values.

When you are in the main menu, you can exit the utility by pressing the **Escape** key. You can save the current selections and exit the utility by pressing the **F10** key. You can change the color scheme of the utility by pressing the **F2** key while holding down the **Shift** key.

When you are in one of the options that displays a dialog box, you can return to the main menu by pressing the **Escape** key.

When you are in one of the options that displays a table of items, you can return to the main menu by pressing the **Escape** key. For some items, you can display a help message by pressing the **F1** key. You can change the color scheme of the utility by pressing the **F2** key while holding down the **Shift** key. You can press **F5** to discard any changes you have made and return all items to the value that they held when the setup utility was started. You can press **F6** to load the displayed items with a standard list of default values. You can press **F7** to load the displayed items with a high-performance list of default values.

Standard CMOS Setup Option

This option displays a table of items which defines basic information about your system.

```
ROM PCI/ISA BIOS (P6EXP-Me)
STANDARD CMOS SETUP
AWARD SOFTWARE, INC.
```

Date (mm:dd:yy) : Mon, Dec 28 1998								
Time (hh:mm:ss) : 12 : 59 : 20								
HARD DISKS	TYPE	SIZE	CYLS	HEAD	PRECOMP	LANDZ	SECTOR	MODE
Primary Master	:	0	0	0	0	0	0	NORMAL
Primary Slave	:	0	0	0	0	0	0	NORMAL
Secondary Master	:	0	0	0	0	0	0	NORMAL
Secondary Slave	:	0	0	0	0	0	0	NORMAL
Drive A : 1.44M, 3.5 in.								
Drive B : None								
Floppy 3 Mode Support : Disabled								
Video : EGA/UGA								
Halt On : All Errors								
ESC : Quit			↑ ↓ → ← : Select Item			PU/PD/+/- : Modify		
F1 : Help			(Shift)F2 : Change Color					

Date and Time

The Date and Time items show the current date and time held by your computer. If you are running a Windows operating system, these items will automatically be updated whenever you make changes to the Windows Date and Time Properties utility.

Hard Disks

Defaults: None

These items show the characteristics of any hard disk drives on the four available IDE channels. (Note that SCSI hard disk drives do not appear here.) You can automatically install most modern hard disks using the IDE HDD Auto Detect Option from the main menu. However, if you find that a drive cannot be automatically detected, you can use these items to select USER, and then manually enter the characteristics of the drive. The documentation provided with your drive provides the data you need to fill in the values for CYLS (cylinders), HEAD (read/write heads), and so on.

The documentation provided with the drive may not tell you what value to use under the MODE heading. If the drive is smaller than 528 MB, set MODE to Normal. If the drive is larger than 528 MB and it supports Logical Block Addressing, set MODE to LBA. Very few high-capacity drives do not support Logical Block Addressing. If you have such a drive, you might be able to configure it by setting the MODE to Large. If you're not sure which MODE setting is required by your drive, set MODE to Auto and let the setup utility try to determine the mode automatically.

Drive A and Drive B

Default: 1.44M, 3.5 in., None

These items define the characteristics of any diskette drive attached to the system. You can connect one or two diskette drives.

Floppy 3 Mode Support**Default: Disabled**

Floppy 3 mode refers to a 3.5" diskette with a capacity of 1.2 MB. Floppy 3 mode is sometimes used in Japan.

Video**Default: EGA/VGA**

This item defines the video mode of the system. This mainboard has a built-in VGA graphics system so you must leave this item at the default value.

Halt On**Default: All Errors**

This item defines the operation of the system POST (Power On Self Test) routine. You can use this item to select which kind of errors in the POST are sufficient to halt the system.

BIOS Feature Setup Option

This option displays a table of items which defines more advanced information about your system. You can make modifications to most of these items without introducing fatal errors to your system.

ROM PCI/ISA BIOS (P6EXP-Me)
BIOS FEATURES SETUP
AWARD SOFTWARE, INC.

CPU Internal Core Speed	: 300MHz	Video BIOS Shadow	: Enabled
Virus Warning	: Disabled	C8000-CBFFF Shadow	: Disabled
CPU Internal Cache	: Enabled	CC000-CFFFF Shadow	: Disabled
External Cache	: Enabled	D0000-D3FFF Shadow	: Disabled
Quick Power On Self Test	: Enabled	D4000-D7FFF Shadow	: Disabled
Boot From LAN First	: Disabled	D8000-DBFFF Shadow	: Disabled
Boot Sequence	: A,C,SCSI	DC000-DFFFF Shadow	: Disabled
Swap Floppy Drive	: Disabled		
Boot Up NumLock Status	: On		
Gate A20 Option	: Fast		
Security Option	: Setup		
PCI/VGA Palette Snoop	: Disabled		
OS Select For DRAM > 64MB	: Non-OS2		
HDD S.M.A.R.T. capability	: Disabled	ESC : Quit	↑↓←→ : Select Item
BIOS Flash	: Disabled	F1 : Help	PU/PD/+/− : Modify
		F5 : Old Values (Shift)F2 : Color	
		F6 : Load BIOS Defaults	
		F7 : Load Optimun Settings	

CPU Internal Core Speed**Default: 300 MHz**

Use this item to automatically set up the mainboard for the kind of Celeron processor that you have installed. Set this item to the rated internal clock speed of the Celeron processor.

Virus Warning**Default: Disabled**

When this item is enabled it provides some protection against viruses which try to write to the boot sector and partition table of your hard disk drive. This item is disabled as a default so that you can install an operating system. We recommend that you enable Virus Warning as soon as you have installed your disk with an OS.

CPU Internal Cache**Default: Enabled**

All the Celeron processors that can be installed in this mainboard use internal (level 1) cache memory to improve performance. Leave this item at the default value Enabled for better performance.

External Cache**Default: Enabled**

All the Celeron processors that can be installed in this mainboard use external (level 2) cache memory to improve performance. Leave this item at the default value Enabled for better performance.

Quick Power On Self Test**Default: Enabled**

You can enable this item to shorten the power on testing and have your system start up a little faster. You might like to enable this item after you are confident that your system hardware is operating smoothly.

Boot From LAN First**Default: Disabled**

Enable this item if the system is part of a network and you want the machine to remote boot an OS from a network server.

Boot Sequence**Default: A,C,SCSI**

This item defines where the system will look for an operating system, and the order of priority. You can boot an operating system from many locations including a SCSI device, a ZIP drive, a floppy diskette drive or an LS-120 high-capacity diskette drive.

Swap Floppy Drive**Default: Disabled**

If you have two floppy diskette drives in your system, this item allows you to swap around the assigned drive letters so that drive A becomes drive B, and drive B becomes drive A.

Boot Up NumLock Status**Default: On**

This item defines if the keyboard Num Lock key is active when your system is started.

Gate A20 Option**Default: Fast**

This option provides compatibility with older software written for the 286 processor. Leave this item at the default value fast.

Security Option**Default: Setup**

If you have installed password protection, this item defines if the password is required at system start up, or if it is only required when a user tries to enter the setup utility.

PCI/VGA Palette Snoop**Default: Disabled**

This item is designed to overcome some problems that can be caused by some non-standard VGA cards. This board includes a built-in VGA system that does not require palette snooping so you must leave this item disabled.

OS Select For DRAM > 64 MB**Default: Non-OS2**

This item is only required if you have installed more than 64 MB of memory and you are running the OS/2 operating system. Otherwise, leave this item at the default Non-OS2.

HDD S.M.A.R.T capability**Default: Disabled**

SMART is an industry acronym for Self-monitoring, Analysis and Reporting Technology. If the documentation of your hard disk states that SMART is supported, you can enable this item.

BIOS Flash**Default: Disabled**

Enable this item if you want to use the Flash BIOS utility to erase the current BIOS and flash a new BIOS to the system firmware. See Chapter 4 for more information.

Video BIOS Shadow**Default: Enabled**

This item allows the video BIOS to be copied to system memory for faster performance.

XXXXX-XXXXX Shadow**Default: Disabled**

These items allow the BIOS of other devices to be copied to system memory for faster performance.

Chipset Features Option

This option displays a table of items that define critical timing parameters of the mainboard components including the CPU, the memory, and the system logic.

As a general rule, you should leave the items on this page at their default values unless you are very familiar with the technical specifications of your system hardware. If you change the values, or load the optimum settings, you may introduce fatal errors or recurring instability into your system. The item list below shows only the default values for some items.

ROM PCI/ISA BIOS (P6EXP-Me)
CHIPSET FEATURES SETUP
AWARD SOFTWARE, INC.

Auto Configuration	: Enabled	Current CPU Temperature	:
DRAM Speed Selection	: 60ns	Current System Temp.	:
MA Wait State	: Slow	Current CPUFAN1 Speed	:
EDO RAS# To CAS# Delay	: 3	Current CPUFAN2 Speed	:
EDO RAS# Precharge Time	: 3	Current Vdd(V)	:
EDO DRAM Read Burst	: x333	Current Vin1(V)	:
EDO DRAM Write Burst	: x222	Current Vin2(V)	:
CPU-To-PCI IDE Posting	: Enabled	Current Vin3(V)	:
System BIOS Cacheable	: Enabled		
Video RAM Cacheable	: Disabled		
8 Bit I/O Recovery Time	: 1		
16 Bit I/O Recovery Time	: 1		
Memory Hole At 15M-16M	: Disabled		
Passive Release	: Enabled		
Delayed Transaction	: Enabled		
Support PCI 2.1	: Disabled		
AGP Aperture Size (MB)	: 64	ESC : Quit	↑↓←→ : Select Item
SDRAM RAS-to-CAS Delay	: Slow	F1 : Help	PU/PD/+/− : Modify
SDRAM RAS Precharge Time	: Slow	F5 : Old Values (Shift)	F2 : Color
SDRAM CAS latency Time	: 3	F6 : Load BIOS Defaults	
		F7 : Load Optimum Settings	

Auto Configuration**Default: Enabled**

Leave this item at the default value enabled. Auto configuration installs preset default values for many of the timing parameters for installed EDO RAM memory:

DRAM Speed Selection**Default: 60ns**

This item sets the timing for the system DRAM in the DRAM timing registers. The default value of 60ns ensures reliability if slower DRAM is installed.

MA Wait State**Default: Slow****EDO RAS# To CAS# Delay****Default: 3****EDO RAS# Precharge Time****Default: 3****EDO DRAM Read Burst****Default: x333****EDO DRAM Write Burst****Default: x222**

When you set the item *Auto Configuration* to enabled, these items are automatically installed with the correct values. We recommend that you leave these items at the Auto Configuration defaults.

CPU-To-PCI IDE Posting**Default: Enabled**

If you enable this item, the system will use a fast buffer for posting writes to memory. This allows release of the CPU before completion of the write cycle.

System BIOS Cacheable**Default: Enabled**

This item allows the system BIOS to be cached for faster performance. We recommend that you leave this item at the default value Enabled.

Video BIOS Cacheable**Default: Disabled**

This item allows the video BIOS to be cached for faster performance. We recommend that you leave this item at the default value Disabled.

8 Bit I/O Recovery Time**Default: 1****8 Bit I/O Recovery Time****Default: 1**

These two items set timing parameters for 8-bit and 16-bit ISA expansion cards. We recommend that you leave these items at the default value 1.

Memory Hole at 15M-16M**Default: Disabled**

This item can be used to reserve memory space for some ISA cards that require it. We recommend that you leave this item at the default value Disabled.

Passive Release**Default: Enabled**

When enabled, CPU to PCI bus accesses are allowed during passive release.

Delayed Transaction**Default: Enabled**

If the chipset has an embedded 32-bit write buffer to support delay transaction cycles, you can enable this item to provide compliance with PCI Ver. 2.1 specifications. We recommend that you leave this item at the default value Disabled.

Support PCI 2.1**Default: Disabled**

You can enable this item if your system chipset supports all the operations of the PCI Ver. 2.1 specifications. We recommend that you leave this item at the default value Disabled.

AGP Aperture Size**Default: 64**

This item defines the size of the aperture if you use an AGP graphics adapter. It refers to a section of the PCI memory address range dedicated for graphics memory.

SDRAMRAS to CAS Delay**Default: Slow**

For SDRAM memory, this item defines the delay between the Row Address Strobe (RAS) and Column Address Strobe (CAS) signals. A shorter delay gives better performance and a longer delay improves stability. We recommend that you leave this item at the default value Slow.

SDRAM RAS Precharge Time:**Default: Slow**

For SDRAM, the precharge time defines the number of clock cycles used by the Row Address Strobe (RAS) to accumulate charge for a refresh. If insufficient time is allowed, the refresh may be incomplete and data can be lost. We recommend that you leave this item at the default value Slow

SDRAM CAS Latency**Default: 3T**

This item defines the timing for SDRAM memory. Leave this item at the default value.

Current CPU Temperature, Current System Temperature, Current CPUFAN1 Speed, etc.

If you are using the hardware monitoring features of this system, you can use these items to set thermal parameters for the system.

Power Management Setup Option

This option displays a table of items which lets you control the power management of the system. Modern operating systems take care of much of the routine power management. This mainboard supports ACPI (advanced configuration and power interface).

This system supports three levels of power-saving modes; doze mode, standby mode, and suspend mode. Standby mode uses less power than doze mode and suspend mode uses the least power.

The power management in the setup utility lets you specify a timeout for each of the power-saving modes, and a timeout for a hard disk drive power down. A timeout, means a period of time when the system (or the hard disk drive) is inactive. If the timeout completes, the system power-saving mode will execute, or the hard disk drive will power down.

On the right side of the Power Management Setup page there is a list named ****Reload Global Timer Events****. If there is activity on any of the items in this list that are enabled, this will automatically reset the timeout counters for the power saving modes.

ROM PCI/ISA BIOS (P6EXP-Me)
POWER MANAGEMENT SETUP
AWARD SOFTWARE, INC.

Power Management : Disabled	** Reload Global Timer Events **
PM Control by APM : Yes	IRQ[3-7,9-15],NMI : Enabled
Video Off Method : DPMS	Primary IDE 0 : Disabled
Video Off After : Standby	Primary IDE 1 : Disabled
MODEM Use IRQ : 3	Secondary IDE 0 : Disabled
Doze Mode : Disable	Secondary IDE 1 : Disabled
Standby Mode : Disable	Floppy Disk : Disabled
Suspend Mode : Disable	Serial Port : Enabled
HDD Power Down : Disable	Parallel Port : Disabled
HDD Down When Suspend: Enabled	
Throttle Duty Cycle : 62.5%	
PCI/UGA Act-Monitor : Disabled	
Soft-Off by PWR-BTIN : Instant-Off	
CPUFAN Off In Suspend: Enabled	
PowerOn by Ring : Enabled	
Resume by Alarm : Disabled	
Wake Up On LAN : Enabled	ESC : Quit ↑↓+* : Select Item
IRQ 8 Break Suspend : Disabled	F1 : Help PU/PD/+/- : Modify
	F5 : Old Values (Shift)F2 : Color
	F6 : Load BIOS Defaults
	F7 : Load Optimum Settings

Power Management**Default: Disabled**

This item acts like a master switch for the power-saving modes and hard disk timeouts. If this item is set to Max Saving, doze, standby, and suspend mode, will occur after a timeout of 10 seconds. If this item is set to Min Saving, doze, standby, and suspend mode will occur after a timeout of 4 hours. If the item is set to User Define, you can insert your own timeouts for the power-saving modes.

PM Control by APM**Default: Yes**

Windows 95 and 98 have built-in power management capabilities called APM (advanced power management). When you enable this item, you allow the APM routines in Windows to operate on your system.

Video Off Method**Default: DPMS**

This item defines how the video is powered down to save power. As a default, this is set to DPMS (display power management software).

Video Off After**Default: Standby**

This option defines which level of power-saving mode is required in order to power down the video display. As a default, the video powers down both in standby mode.

Modem Use IRQ**Default: 3**

If you would like an incoming call on a modem to automatically resume the system from suspend mode, use this item to specify the interrupt request line (IRQ) that is used by the modem.

Doze Mode**Default: Disabled**

If you have selected User Define for the Power Management item, you can set this item to a selection of timeouts from 10 seconds to 4 hours.

Standby Mode**Default: Disabled**

If you have selected User Define for the Power Management item, you can set this item to a selection of timeouts from 10 seconds to 4 hours.

Suspend Mode**Default: Disabled**

If you have selected User Define for the Power Management item, you can set this item to a selection of timeouts from 10 seconds to 4 hours.

HDD Power Down**Default: Disabled**

If you have selected User Define for the Power Management item, you can set this item to a selection of timeouts from 1 to 15 minutes.

HDD Down When Suspend**Default: Enabled**

If this item is enabled, the hard disk drive will automatically power down whenever the system enters suspend mode.

Throttle Duty Cycle**Default: 62.5%**

This item defines what percentage of time the system will halt the processor clock when it is in power-saving mode.

PCI/VGA Act-Monitor**Default: Disabled**

When this item is enabled, it means that any activity on the active monitor will restart the Standby mode timeout counter.

Soft-Off by PWR-BTTN**Default: Instant-Off**

Under ACPI (advanced configuration and power interface) the system can be turned off mechanically (by the power button) or it can undergo a software power off. If the system has been turned off by software, the system can be resumed by a LAN, MODEM or ALARM wake up signal. This item allows you to define a software power off using the power button. If the value is set to Instant-Off, the power button will automatically cause a software power off. If the value is set to Delay 4 Sec. the power button must be held down for a full four seconds to cause a software power off.

CPUFAN Off In Suspend**Default: Enabled**

If this item is enabled, the processor cooling fan will turn off when the system is in suspend mode.

PowerOn by Ring**Default: Enabled**

If this item is enabled, it allows the system to resume from a software powerdown whenever there is an incoming call to an installed fax/modem.

Resume by Alarm**Default: Disabled**

If this item is enabled, it allows the system to resume from a software powerdown whenever a pre-set wake up alarm time is reached. If you enable this item, two items appear below which allow you to set the date and time of the wake up alarm.

Wake Up On LAN**Default: Enabled**

If this item is enabled, it allows the system to resume from a software powerdown whenever there is incoming traffic to an installed network adapter.

IRQ 8 Break Suspend**Default: Disabled**

When this item is enabled, any activity through the system interrupt request line 8 can reset power-saving mode timeouts to zero, or resume the system from a power saving mode. IRQ 8 is normally used by the system realtime clock.

IRQ[3-7, 9-15],NMI**Default: Enabled**

When this item is enabled, the system will restart the power-saving timeout counters when any activity is detected on the system interrupts (IRQs) and the non-masked interrupt (NMI).

Primary IDE 0**Default: Disabled****Primary IDE 1****Default: Disabled****Secondary IDE 0****Default: Disabled****Secondary IDE 1****Default: Disabled****Floppy Disk****Default: Disabled**

When these items are enabled, the system will restart the power-saving timeout counters when any activity is detected on any of the drives or devices on the primary or secondary IDE channels, or any of the drives connected to the floppy disk drive controller

Serial Port**Default: Enabled****Parallel Port****Default: Disabled**

When these items are enabled, the system will restart the power-saving timeout counters when any activity is detected through the system's serial ports, or the parallel port.

PNP/PCI Configuration Option

This option displays a table of items that configures how PNP (Plug and Play) and PCI expansion cards operate in your system. If you have not installed PCI cards in the expansion slots, you do not need to make any changes to this option.

ROM PCI/ISA BIOS (P6EXP-Me)
PNP/PCI CONFIGURATION
AWARD SOFTWARE, INC.

PNP OS Installed : No	PCI IDE IRQ Map To : PCI-AUTO
Resources Controlled By : Auto	Primary IDE INT# : A
Reset Configuration Data : Disabled	Secondary IDE INT# : B
	Assign IRQ For USB : Enabled
	ESC : Quit F10 : Select Item
	F1 : Help PU/PD/+/- : Modify
	F5 : Old Values (Shift)F2 : Color
	F6 : Load BIOS Defaults
	F7 : Load Optimum Settings

PNP OS Installed

Default: No

If you have installed a Plug and Play operating system such as Windows 95 or 98, you can change this item to Yes. When the item is set to Yes you can use the Device Manager utility in the operating system to make changes to the configuration of expansion cards.

Resources Controlled By

Default: Auto

You should leave this item at the default Auto. If you find that you cannot get a particular expansion card to work properly, you might be able to solve the problem by changing this item to Manual, and defining the characteristics of the card in the new items which appear.

If you change this item to Manual, the display will list a series of items that allow you to define the assignments of the system interrupt lines (IRQs) and Direct Memory Access (DMA) channels. As a default, these items are set to PCI/ISA PnP. If you install an ISA-bus card that does not support PNP, and it requires a special IRQ and DMA, you can modify the list of assignments. Change the values of the IRQ and DMA that are required to Legacy ISA.

Reset Configuration Data

Default: Disabled

If you enable this item and restart the system, any PNP configuration data stored in the BIOS setup will be cleared from memory. New updated configuration data will be created.

PCI IDE IRQ Map To

Default: PCI-AUTO

Primary IDE INT#

Default: A

Secondary IDE INT#

Default: B

These items select if you are using PCI IDE channels or ISA-bus IDE channels. If you are using PCI IDE, two other fields appear which show the mapping of the primary and

secondary channels. Leave this item at the default value unless you have disabled the onboard IDE channels and are using an ISA bus IDE card.

Assign IRQ For USB

Default: Enabled

When this item is enabled, the system can assign an IRQ to devices connected on the USB port.

Load BIOS Defaults Option

This option displays a dialog box which allows you to install BIOS defaults for all appropriate items in the whole setup utility. Press the **Y** key and then the **Enter** key to install the defaults. Press the **N** key and then **Enter** to not install the defaults. The BIOS defaults do not place great demands on the system and are generally very stable. If your system is not functioning correctly, you might like to install the BIOS defaults as a first step in getting your system working properly again. If you only want to install BIOS defaults for a specific option, select and display that option, and then press the **F6** key.

Load Optimum Settings Option

This option displays a dialog box which allows you to install optimum defaults for all appropriate items in the whole setup utility. Press the **Y** key and then the **Enter** key to install the defaults. Press the **N** key and then **Enter** to not install the defaults. The optimum defaults can place some demands on the system that are greater than the performance level of the components, such as the processor and the memory. You could cause fatal errors or recurring instability if you install the setup defaults when your hardware does not support it. If you only want to install setup defaults for a specific option, select and display that option, and then press the **F7** key.

Integrated Peripherals Option

This option displays a list of items which defines the operation of some peripheral items on the system's input/output ports.

ROM PCI/ISA BIOS (PGEXP-Me)
INTEGRATED PERIPHERALS
AWARD SOFTWARE, INC.

IDE HDD Block Mode	: Enabled	UART Mode Select	: IrDA
IDE Primary Master PIO	: Auto	RxD , TxD Active	: Hi,Lo
IDE Primary Slave PIO	: Auto	IR Transmittiion delay	: Enabled
IDE Secondary Master PIO	: Auto	Onboard Parallel Port	: 378/IRQ7
IDE Secondary Slave PIO	: Auto	Parallel Port Mode	: ECP
IDE Primary Master UDMA	: Auto	ECP Mode Use DMA	: 3
IDE Primary Slave UDMA	: Auto	EPP Mode Select	: EPP1.7
IDE Secondary Master UDMA	: Auto	AC Resume After PWR-Loss	: Off
IDE Secondary Slave UDMA	: Auto		
On-Chip Primary PCI IDE	: Enabled		
On-Chip Secondary PCI IDE	: Enabled		
USB Keyboard Support	: Disabled		
Init Display First	: PCI Slot		
POWER ON Function	: Hot Key		
KB Power ON Password	: Enter	ESC : Quit	↑↓←→ : Select Item
Hot Key Power ON	: Ctrl-F12	F1 : Help	PU/PD/+/- : Modify
Onboard FDC Controller	: Enabled	F5 : Old Values (Shift)F2 : Color	
Onboard Serial Port 1	: 3F8/IRQ4	F6 : Load BIOS Defaults	
Onboard Serial Port 2	: 2F8/IRQ3	F7 : Load Optimum Settings	

IDE HDD Block Mode

Default: Enabled

Block mode transfers can improve the access to IDE devices. Enable this item if your IDE devices support block mode transfers.

IDE Primary Master PIO

Default: Auto

IDE Primary Slave PIO

Default: Auto

IDE Secondary Master PIO

Default: Auto

IDE Secondary Slave PIO

Default: Auto

Each IDE channel supports a master device and a slave device. These four items let you assign which kind of PIO (Programmed Input/Output) is used by IDE devices. You can choose Auto, to let the system auto detect which PIO mode is best, or you can install a PIO mode from 0-4.

IDE Primary Master UDMA

Default: Auto

IDE Primary Slave UDMA

Default: Auto

IDE Secondary Master UDMA

Default: Auto

IDE Secondary Slave UDMA

Default: Auto

Each IDE channel supports a master device and a slave device. This motherboard supports UltraDMA. UltraDMA technology provides faster access to IDE devices. If you install a device which supports UltraDMA, change the appropriate item on this list to Auto. You may have to install the UltraDMA driver supplied with this motherboard in order to use an UltraDMA device.

On-Chip Primary PCI IDE

Default: Enabled

On-Chip Secondary PCI IDE

Default: Enabled

These items allow you to enable or disable the primary and secondary IDE channels built into this mainboard.

USB Keyboard Support

Default: Disabled

Enable this item if you are using a keyboard connected through the USB interface.

Init Display First **Default: PCI Slot**

Use this item to define if your graphics adapter is installed in one of the PCI slots, or if you have installed an AGP graphics adapter into the AGP slot.

Power On Function **Default: Hot Key**
KB Power ON Password **Default: Enter**
Hot Key Power ON **Default: Ctrl-F12**

The Power On Function item allows you to power on the system by pressing hot-keys, or typing in a password. If you choose Password, you can use the item KB Power On Password to install a power on password. If you set this item to Hot Key, you can then use the item Hot Key Power On to choose which hot keys are installed.

Onboard FDC Controller **Default: Enabled**

Use this item to turn on or off the floppy disk controller that is built into this mainboard.

Onboard Serial Port 1 **Default: 3F8/IRQ4**

This item lets you disable the built-in serial port 1, or enable it by assigning an I/O address and an Interrupt Request Line (IRQ).

Onboard Serial Port 2 **Default: 2F8/IRQ3**

This item lets you disable the built-in serial port 2, or enable it by assigning an I/O address and an Interrupt Request Line (IRQ).

UART Mode Select **Default: IrDA**

This item defines the operation of serial port 2. In the Normal setting, serial port 2 is assigned to the connector on the mainboard. If you have installed an optional infrared port, you must change the setting of this item to one of the Infrared settings (usually IrDA or ASKIR). These settings will disable the mainboard serial port connector and assign serial port 2 to the infrared device. If you have selected an IR mode, two items appear, *RxD*, *TxD Active* and *IR Transmission delay*, which let you set the duplex and transmission parameters for the Infrared port. See the documentation of your infrared port for help on these items.

Onboard Parallel Port **Default: 378/IRQ7**

This item lets you disable the built-in parallel port, or enable it by assigning an I/O address and an Interrupt Request Line (IRQ).

Parallel Port Mode **Default: SPP**

This item defines the operation of the parallel port. As a default it is set to SPP (standard parallel port). If you are connected to a parallel device that supports the higher-performance EPP (enhanced parallel port) or the ECP (extended capabilities port) make the appropriate changes to this item. If you change the parallel port to EPP or ECP, new items appear to let you configure the EPP and ECP modes.

AC Resume After PWR-Loss **Default: Off**

If this item is enabled, the system will automatically resume when power is restored after an interruption in the power supply.

Password Settings

This item can be used to install a password. To install a password, follow these steps:

1. Highlight the item Password Settings on the main menu and press **Enter**.
2. The password dialog box will appear.
3. If you are installing a new password, carefully type in the password. You cannot use more than 8 characters or numbers. The password will differentiate between upper case and lower characters. Press **Enter** after you have typed in the password. If you are deleting a password that is already installed just press **Enter** when the password dialog box appears.
4. The system will ask you to confirm the new password by asking you to type it in a second time. Carefully type the password again and press **Enter**, or just press **Enter** if you are deleting a password that is already installed.
5. If you typed the password correctly, the password will be installed.

IDE HDD Auto Detection Option

This item automatically detects and installs any hard disk drives installed on the primary and secondary IDE channel. Most modern drives can be detected. If you are using a very old drive that can't be detected, you can install it manually using the Standard CMOS Setup option.

Setup will check for two devices on the primary IDE channel and then two devices on the secondary IDE channel. At each device, the system will flash an N in the dialog box. Press **Enter** to skip the device and proceed to the next device. Press **Y**, then **Enter** to tell the system to auto-detect the device.

Save And Exit Setup Option

Highlight this item and press **Enter** to save the changes that you have made in the setup utility and exit the setup program. When the Save and Exit dialog box appears, press **Y** to save and exit, or press **N** to return to the setup main menu.

Exit Without Saving Option

Highlight this item and press **Enter** to discard any changes that you have made in the setup utility and exit the setup program. When the Exit Without Saving dialog box appears, press **Y** to discard changes and exit, or press **N** to return to the setup main menu.

Chapter 4: Software

About the Software

The support software for this mainboard is supplied on a CD-ROM disk. The CD-ROM disk has a **UTILITY** folder, and individual folders for all the different kinds of mainboards which are supported with this disk. You can install the software that is stored in the **UTILITY** folder and the software that is stored in the **P6EXP-ME** folder. The folder **CMI8338** contains audio drivers and software for mainboards which use the Elite PCI Audio-CMI8338 audio chip, as this mainboard does.

Utility Folder

The utility folder has the following sub-folders:

- ❑ **AWDFLASH**: software to erase and install new revisions of the system BIOS
- ❑ **DIRECTX5**: software display drivers for Microsoft's DirectX Rev. 5 specification
- ❑ **PC-CILLIN**: anti-virus software

P6EXP-ME Folder

The P6EXP-ME folder has the following sub-folders:

- ❑ **AUDIO**: this folder is empty. Please use the audio software stored in the folder **CMI8338** on the CD-ROM.
- ❑ **MONITOR**: software for hardware monitoring for system's that have installed the GL520SM monitoring chip.
- ❑ **TRIONES-IDE**: Bus mastering UltraDMA IDE drivers for Windows 9x/NT.
- ❑ **INTEL-IDE**: Alternative Bus mastering UltraDMA IDE drivers for systems which use Intel chipsets.

Utility Folder Installation Guide

1. Place the support disk in your CD-ROM drive. If you are running Windows with Autoplay enabled, the opening screen of the support CD should appear automatically. Click on the item **READ ME** and read the latest instructions.
2. Click on the item **BROWSE THE CD TITLE**. This uses Windows Explorer to show the contents of the support CD.
3. Double click the **Utility** folder, and then click on the sub-folder which contains the software that you want to install.
4. Before installing the software, look for a file named **README.TXT**, or something similar. This file may contain important information to help you install the software correctly.

5. Some software may be installed in separate folders for different operating systems, such as DOS, WIN NT, WIN95/98, and so on. Always log on to the correct folder for the kind of operating system you are using.

Utility Installation Notes

Award Flash Memory Utility

This utility lets you erase the system BIOS that is stored on the system motherboard on a Flash Memory chip, and lets you write a new or updated BIOS onto the chip. Take care how you use this program. If you erase the current BIOS and fail to write a new BIOS, or write a new BIOS that is unsuitable, your system will malfunction.

The flash memory utility is called AWDFLASH.EXE. To use this utility, you must be in real-mode DOS (not the DOS box that is available in Windows 95/98/NT). If you are using WINDOWS 95/98, shut down your computer and select the option Restart in DOS in the shut-down dialog box. If you are running Windows NT, shut down your computer and boot from a DOS diskette temporarily in order to run the flash memory utility.

DirectX5 Drivers

The DirectX drivers are for installation only in Windows 95/98. The DirectX drivers need to be installed before you install an AGP driver. You may be able to get more up-to-date DirectX drivers from the Microsoft web site. Start the installation by clicking on the file DX5CORE.EXE.

PC-Cillin Anti-Virus Utility

Anti-virus software is provided for DOS, for WIN95, and WIN 98. Log on to the appropriate directory for your operating system. For DOS, copy all the files in the DOS folder to your hard disk drive. For Windows 95, log on to the Disk 1 folder and run SETUP. For Windows 98, run SETUP.

Mainboard Folder Installation Guide

1. Place the support disk in your CD-ROM drive. If you are running Windows with Autoplay enabled, the opening screen of the support CD should appear automatically. Click on the item READ ME and read the latest instructions.
2. Click on the item BROWSE THE CD TITLE. This uses Windows Explorer to show the contents of the support CD.
3. Double click the folder that is named after the kind of mainboard that you are using., and then click on the sub-folder which contains the software that you want to install.
4. Before installing the software, look for a file named README.TXT, or something similar. This file may contain important information to help you install the software correctly.
5. Some software may be installed in separate folders for different operating systems, such as DOS, WIN NT, WIN95/98, and so on. Always log on to the correct folder for the kind of operating system you are using.

Mainboard Installation Notes

Audio Software

This folder is empty. See the instructions below for installing the audio software from the CMI8338 folder.

System Monitoring Utility

This software is for use by mainboards which have the GL520SM system monitoring chip. Software is provided for Windows 95/98/NT. Open the WIN95/98 folder or the WINNT folder and then run the SETUP program.

Triones Bus Master IDE Drivers

Drivers are provided for Windows 9x (Xstore IDE Drivers), Windows NT 3.5, and Windows NT 4.0.

For Windows 9x

Log on to the folder and then run the SETUP program.

For Windows NT 3.5

1. From the Program Manager, double click on "*Windows NT Setup*" in the Main group.
2. Select "*Options/Add/Remove SCSI Adapters...*"
3. Click on Add.
4. The "*Select SCSI Adapter Option*" dialog will appear; select "*Other (Requires a disk from a hardware manufacturer)*" from the "*Adapter:*" list box.
5. Next, the "*Insert Diskette*" dialog box will appear; browse to the correct folder on the support CD-ROM.

6. Next, the *"Select OEM Option"* dialog box will appear; select *"PIIX/PIIX4 Bus Master EIDE/ATAPI"* and click *"OK."*
7. Next, the *"Select SCSI Adapter Option"* dialog box will appear; click on the *"Install"* button in the dialog box. If installation is successful, the *"SCSI Adapter Setup"* dialog box will reappear, and *"PIIX/PIIX4 Bus Master EIDE/ATAPI"* will be listed. That means the driver is installed.
8. Reboot your system to load the driver.

For Windows NT 4.0

1. Insert the Support Disk into the CD-ROM drive.
2. Open *My Computer*.
3. Open *Control Panel*.
4. Open *SCSI Adapters*.
5. Click *"Drivers"*.
6. Select *"IDE CD-ROM (ATAPI 1.2)/Dual-channel PCI IDE Controller"* and then click *"Remove"* to remove it.
7. Click *"Add..."*.
8. Click *"Have Disk..."*.
9. Browse to the appropriate folder on the CD-ROM; then click *"OK"*.
10. Select *"PIIX Bus Master EIDE/ATAPI"*, then click *"OK"*.
11. Click *"Continue"*.
12. Click *"Yes"* to restart your computer to use the bus master driver.

Intel Bus Master IDE Drivers

Alternative Bus mastering UltraDMA IDE drivers.

CMI8338 Audio Folder Installation Guide

This folder has software and drivers for mainboards which use the Elite PCI Audio-CMI8338 audio chip. Drivers are provided for Windows 95/98, Windows NT, and DOS. An MS-WORD format manual is stored in the MANUAL folder.

DOS Installation

Log on to the DOSDRV folder and run the program INSTALL.EXE

Windows 95/98 Installation

Please specify the path to the CD-ROM\CMMI8338\W95-98\DRV when your system detects the installed audio system. To install the audio applications, log on to the W95-98 folder, and then log on to the APPS folder. Run the SETUP program.

Windows NT 4.0 Installation

1. Press the *"Start"* button.
2. Move the highlight to *"Settings"* and select *"Control Panel"*.
3. Double click on the *"Multimedia"* icon.
4. Select the *"Devices"* tab.
5. Press the *"Add..."* button.

6. Select item *"Unlisted or Updated Driver"* in *"List of Drivers"* list box.
7. Specify the path to the PCI audio NT drivers.
8. Select *"C-Media CM8338 PCI Device"* and press the *"OK"* button.
9. Choose proper I/O or the *"OK"* button for the default setting.
10. Restart the Windows NT system.

To install the audio applications, log on to the NT4 folder, and then log on to the APPS folder. Run the SETUP program.

Appendix 1: Quick Jumper Setting Reference

JP1: Clear CMOS memory jumper

Use this 3-pin jumper top clear all the current data stored in the CMOS memory.

Function	Jumper Cap
Normal operation	Short pins 1-2
Clear CMOS	Short pins 2-3

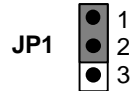

JP2: Keyboard power on jumper

Use this 3-pin jumper to enable keyboard power on with hot keys or password.

Function	Jumper Cap
Enable keyboard power on	Short pins 2-3
Disable keyboard power on	Short pins 1-2

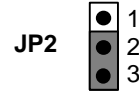

JP4: Audio enable/disable jumper

Use this jumper to enable or disable the audio system integrated on the mainboard.

Function	Jumper Cap
Enable audio	Short Pins 1-2
Disable audio	Short pins 2-3

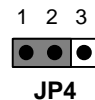

JP5: SPDIF output signal level jumper

Use this 2-pin jumper to set an SPDIF output signal of 0.5V or 5V

Function	Jumper Cap
5 volts	Short pins 1-2
0.5 volts	Open pins 1-2



PANEL1: Panel connectors for switches and indicators

Use the panel connector to implement the switches and indicators on your system case.

Function	Pins
Speaker	1, 3, 5, +7
Power Indicator	+2, +4, 6
Keylock	+8, 10
Green Indicator	+13, 14
Hard Disk Indicator	+15, 16
Reset Switch	17, 18
Suspend Switch	19, 20
Power Switch	21, 22

