

## **Safety Compliance**

### ***Federal Communications Commission (FCC)***

This equipment has been tested and found to comply with the limits for a Class B digital device, pursuant to Part 15 of the FCC Rules. These limits are designed to provide reasonable protection against harmful interference in a residential installation. This equipment generates, uses, and can radiate radio frequency energy and, if not installed and used in accordance with the instructions, may cause harmful interference to radio communications. However there is no guarantee that interference will not occur in a particular installation. If this equipment does cause harmful interference to radio or television reception, which can be determined by turning the equipment off and on, the user is encouraged to try to correct the interference by one or more of the following measures:

- Reorient or relocate the receiving antenna.
  - Increase the separation between the equipment and the receiver.
  - Connect the equipment onto an outlet on a circuit different from that to which the receiver is connected.
  - Consult the dealer or an experienced radio/TV technician for help.
- Shielded interconnect cables and shielded AC power cable must be employed with this equipment to insure compliance with the pertinent RF emission limits governing this device. Changes or modifications not expressly approved by the system's manufacturer could void the user's authority to operate the equipment.

#### ***Declaration of Conformity***

This device complies with part 15 of the FCC rules. Operation is subject to the following conditions:

- This device may not cause harmful interference, and
- This device must accept any interference received, including interference that may cause undesired operation.

### ***Canadian Department of Communications***

This class B digital apparatus meets all requirements of the Canadian Interference-causing Equipment Regulations.

Cet appareil numérique de la classe B respecte toutes les exigences du Règlement sur le matériel brouilleur du Canada.

## **Important Information**

### ***Copyright***

This publication, including all photographs, illustrations and software, is protected under international copyright laws, with all rights reserved. Neither this manual, nor any of the material contained herein, may be reproduced without the express written consent of the manufacturer.

### ***Disclaimer***

The information in this document is subject to change without notice. The manufacturer makes no representations or warranties with respect to the contents hereof and specifically disclaims any implied warranties of merchantability or fitness for any particular purpose. Further, the manufacturer reserves the right to revise this publication and to make changes from time to time in the content hereof without obligation of the manufacturer to notify any person of such revision or changes.

### ***Trademark Recognition***

Microsoft, MS-DOS and Windows are registered trademarks of Microsoft Corp.

MMX, Pentium, Pentium-II, Pentium-III, Celeron are registered trademarks of Intel Corporation.

VGA, OS/2, PS/2 are registered trademarks of International Business Machines.

AMD, K5, K6 are registered trademarks of Advanced Micro Devices Inc.

Cyrix, M1 are registered trademarks of Cyrix Corporation.

Other product names used in this manual are the properties of their respective owners and are acknowledged.

Version 3.0

# Chapter 1: Introduction

## Welcome

---

Congratulations on your purchase of the P6BAP-A+ mainboard. This mainboard features the latest Elite ET82C693A/596B chipset. This is a very special mainboard which allows you to install almost any kind of Intel Pentium-II/III processor. The P6BAP-A+ is a full-sized ATX board measuring 305x220mm and using 4-layer printed circuit board.

The P6BAP-A+ includes a PPGA (Plastic Pin Grid Array) Celeron Socket-PGA370 processor socket. **This feature means that you can install the mainboard with one of the new generation PPGA Celeron cartridges.**

In addition, the mainboard supports 66 MHz, 100MHz, or a 133 MHz memory bus, so you can use 66MHz or 100MHz memory chips, or higher-performance PC-133 memory chips. The board is installed with an integrated PCI-3D sound system and has a full suite of I/O ports. Seven expansion slots are available for system development and hardware monitoring is supported.

This board allows complete flexibility. System integrators can choose from a wide range of PPGA Celeron processors to build the right system, according to their computing needs.

This chapter contains the following information:

- About the Manual** explains how the information in this manual is organized
- Checklist** comprises a list of the standard and optional components that are shipped with this mainboard,
- Features** highlights the functions and components that make this one of the best value mainboards on the market

## About the Manual

---

The manual consists of the following chapters:

### ***Introduction***

Use the **Introduction** Chapter to learn about the features of the mainboard, and the checklist of items that are shipped with the package.

### ***Installation***

Use the **Installation** Chapter to learn how to install the mainboard and get your system up and running.

### ***Setup***

Use the **Setup** Chapter to configure the mainboard for optimum performance.

### ***Software***

Use the **Software** Chapter to learn how to use the software drivers and support programs that are provided with this mainboard.

## Checklist

---

Compare the contents of your mainboard package with the standard checklist below. If any item is missing or appears damaged, please contact the vendor of your mainboard package.

### ***Standard Items***

- ✓ 1 x P6BAP-A+ Mainboard
- ✓ 1 x Cable/Bracket Pack
  - Diskette drive ribbon cable
  - IDE drive ribbon cable
- ✓ This User's Manual
- ✓ Software Support CD-ROM Disc

### ***Optional Items***

- ✓ 1 x V 9.0 Fax/Modem Card

## ■ Features

---

The key feature of this mainboard is the support for PPGA Celeron processors. In addition, this is a full-sized ATX mainboard with a full set of expansion slots for maximum development potential.

### ***Support for PPGA Celeron***

The principal feature of this mainboard is that it can support the latest choice of PPGA Celerons.

The new generation PPGA Celeron processors ship in the familiar square plastic package, and they install in a Zero Insertion Force (ZIF) socket called a Socket-370. The new Celeron processors are close to Pentium-II performance because they include a level-2 cache memory of 128K. However, they operate at a 66/100 MHz system bus and they currently ship a clock speeds of 533 MHz.

System assemblers can install a second generation PPGA Celeron in the Socket-370 processor socket, and choose the processor they need to meet performance or price targets. You can configure the system for any of the supported processor clock speeds using the BIOS setup utility. It is not necessary to set switches or jumpers.

### ***Choice of Memory Options***

The board has three DIMM slots for the installation of 168-pin, 3.3V standard or registered SDRAM (Synchronous Dynamic Random Access Memory) memory modules. The system supports memory that has built-in error correction (EC), error correction code (ECC), or has no error correction.

If you install the PPGA Celeron processor, you can install memory that operates at 66 MHz (you can install PC-100 memory if you wish, but the system will run the memory at 66 MHz).

You can install one, two or three modules. Each memory module can hold a maximum capacity of 128 MB of standard SDRAM chips, or 256 MB of registered SDRAM chips so maximum memory capacity is 384 MB of standard SDRAM memory or 768 MB registered SDRAM memory.

### ***Highly Integrated Design***

This board uses the Elite ET82C693A/596B chipset. The ET82C693A forms the north bridge and supports system buses of 66, 100 and 133MHz. It is AGP Rev. 1 compliant and supports 3.3v AGP devices operating over a 66/133 MHz bus. The memory bus supports the fastest

access (X-1-1-1) for 66 MHz ,100MHz and 133MHz operation. The board is compliant with PCI Rev.2.1 operating at 33 MHz Four PCI Bus masters are supported.

The south bridge is provided by the 596B. This chip supports ACPI (Advanced Configuration and Power Interface) Rev 1.0, onboard PCI IDE channels(DMA66), USB ports, and a System Management Bus for OS control and configuration of devices.

#### ***Built-in PCI 3D Sound***

The Elite PCI Audio CMI 8738 is a single chip solution for PCI-bus 3D audio. The chip provides Sound Blaster 16-bit-compatible audio, plus support for Microsoft's DirectSound 3D specification and Aureal A3D interface. The sound ports include jacks for speakers, microphone and stereo in, and a game/MIDI port. The audio system supports full duplex operation and drivers are available for WIN 95/98 and WIN NT 4.0. The audio system can output sound to 4 loudspeakers and also supports SPDIF 24-bit digital sound input and output.

#### ***Optional Built-in Communications***

The mainboard has an integrated fax/modem connector. As an option, you can purchase a fax/modem extension bracket which connects the line and telephone RJ11 sockets to the board. The fax/modem supports the V.90 protocol that allows transmissions at up to 56Kbps and is fully compatible with earlier transmission and error correction standards. It supports automatic fall back and caller ID.

#### ***Maximum Expansion Options***

This is a full-sized ATX mainboard that offers the maximum in system expansion. The board has a total of 7 expansion slots. The AGP slot can be used by an AGP graphics adapter. The four 32-bit PCI slots can be used by PCI expansion cards, and the two 8/16-bit ISA slots can be used by legacy ISA expansion cards. One of the PCI slots is shared with one of the ISA slots. This means that you can use either one of these slots but not both at the same time. With six usable slots, this mainboard can be installed with a full set of optional expansion cards.

#### ***Integrated I/O***

Using the Winbond W83977EF-AW I/O chip and the Intel BX chipset, the board has a comprehensive set of integrated I/O ports. The I/O port array features PS/2 keyboard and mouse ports, a parallel port, two USB ports, two serial ports, a game/MIDI port, and three audio jacks. Optionally, you can use the built-in mainboard header to add in an infrared port. The mainboard has two PCI-IDE channels and a floppy disk drive interface.

### ***Hardware Monitoring***

The mainboard is installed with the GL520SM hardware monitoring chip. Using this chip and the monitoring software supplied with the system, users and system administrators can monitor critical parameters such as the CPU temperature, the fan speeds and so on. Hardware monitoring helps maintain the system and reduce maintenance costs and downtime.

### ***Keyboard Power On Feature***

Using the system BIOS setup program, you can configure the system to turn on using a keyboard-typed password or hot key. A green keyboard is not required.

### ***Programmable Firmware***

The mainboard includes Award BIOS that allows BIOS setting of CPU parameters. The fully programmable firmware enhances the system features and allows users to set power management, CPU and memory timing, LAN and modem wake-up alarms, and so on. The firmware can also be used to set parameters for different processor clock speeds so that you don't need to change mainboard jumpers and switches.

## Chapter 2: Installation

### Before You Begin

---

Before you begin to install your P6BAP-A+ mainboard, take some precautions to ensure that you avoid the possibility of damage to the product from static electricity. Ensure too that you are installing the mainboard into a suitable case.

#### ***Static Electricity***

In adverse conditions, static electricity can accumulate and discharge through the integrated circuits and silicon chips on this product. These circuits and chips are sensitive and can be permanently damaged by static discharge.

- ◆ If possible wear a grounding wrist strap clipped to a safely grounded device during the installation.
- ◆ If you don't have a wrist strap, discharge any static by touching the metal case of a safely grounded device before beginning the installation.
- ◆ Leave all components inside their static-proof bags until they are required for the installation procedure.
- ◆ Handle all circuit boards and electronic components carefully. Hold boards by the edges only. Do not flex or stress circuit boards.

#### ***Choosing a Case***

The P6BAP-A+ mainboard complies with the specifications for a full-sized ATX board. Make sure that your system case supports a full-size ATX board and has a power supply unit for all the expansion potential of the system.

Some features on the mainboard are implemented by cabling connectors on the mainboard to indicators and switches on the system case. Ensure that your case supports all the features required. The P6BAP-A+ mainboard can support one or two floppy diskette drives and four



enhanced IDE drives. Ensure that your case has sufficient power and space for all the drives that you intend to install.

The mainboard has a set of I/O ports on the rear edge. Ensure that your case has an I/O template that supports the I/O ports and expansion slots.

## Mainboard Guide

Use the following illustration and key to identify the components on your mainboard.

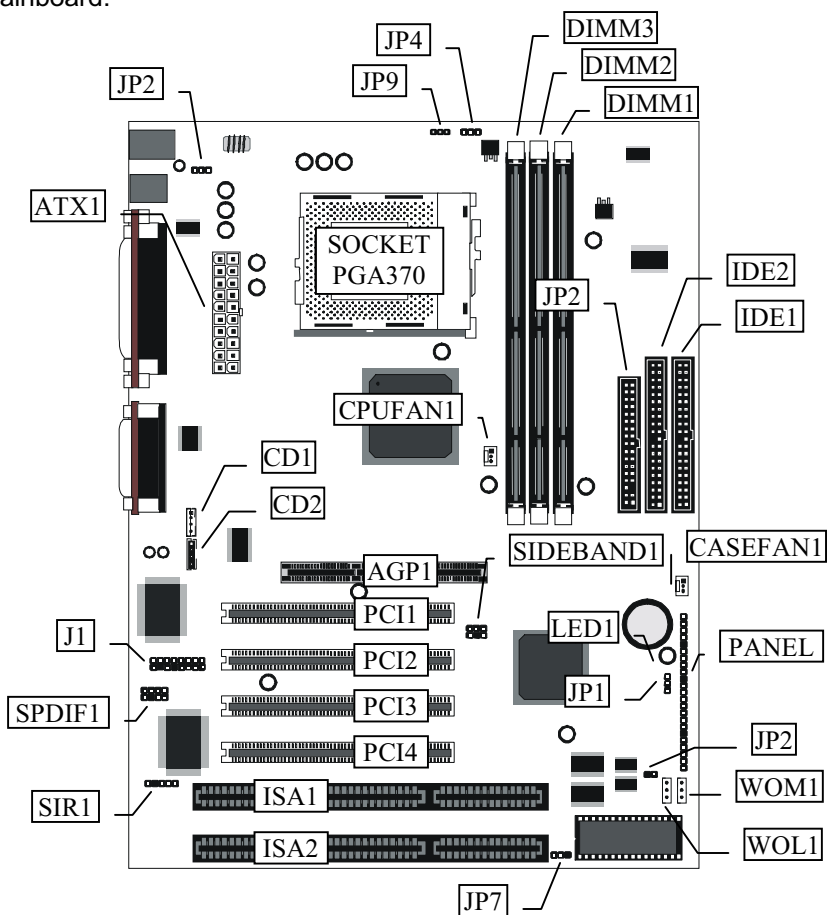

## Key to Mainboard Components

Component	Description
ISA1,2	2 x 8/16-bit ISA expansion slots
AGP1	AGP graphics adapter slot
PCI 1,2,3,4	4 x 32-bit PCI expansion slots
SOCKET PGA370	Processor socket for PPGA Celeron processor
DIMM1,2,3	Slots for 168-pin memory modules
FDD1	Connector for floppy disk drives
IDE1, IDE2	Primary and secondary IDE channels
ATX1	Connector for ATX power supply
SIR1	Connector for optional IR port
PANEL	Panel connector for switches and indicators
CPUFAN1	Power connector for CPU cooling fan
CASEFAN1	Power connector for case cooling fan
WOM1	Connector for modem wake up
WOL1	Connector for LAN wake up
SPDIF1	SPDIF In/out connector (24-bit digital audio interface)
SIDEBAND1	SB-Link connector for Sound Blaster audio card
CD1	Audio connector for optional CD-ROM drive
CD2	Auxiliary audio connector for optional CD-ROM drive
J1	Connector for fax/modem Adapter Card
JP1	Clear CMOS memory jumper
JP2	Keyboard power on jumper
JP4	System Bus Frequency Selector (Force 100MHz)
JP7	Flash BIOS enable/disable jumper
JP9	System Bus Frequency Selector (Force 133MHz)
LED1	Suspension indicator

## I/O Ports Side View

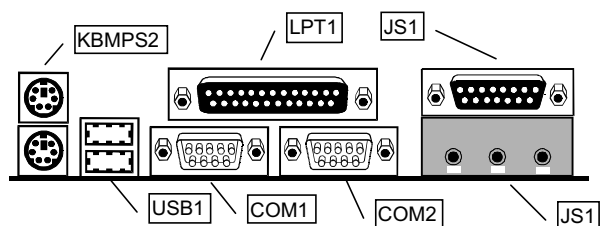

### Key to I/O Ports

Component	Description
KBMPS2	PS/2 port for pointing device (upper port) PS/2 port for keyboard (lower port)
LPT1	External parallel port
JS1 (Upper)	External game/MIDI port
JS1 (Lower)	Audio jacks for (left to right) line out, line in, microphone
COM2	External monitor port
COM1	External serial port 1/3
USB1	Two stacked Universal Serial Bus ports

## Preparing the Mainboard

---

Prepare the main board by carrying out the following steps;

- ◆ Install the processor
- ◆ Install the memory module(s)
- ◆ Check the jumper settings

### ***Install the Processor***

This board has a socket-370 for a PPGA Celeron processor. You can install one PPGA Celeron.

#### ***Locate Socket-370 and CPUFAN1***

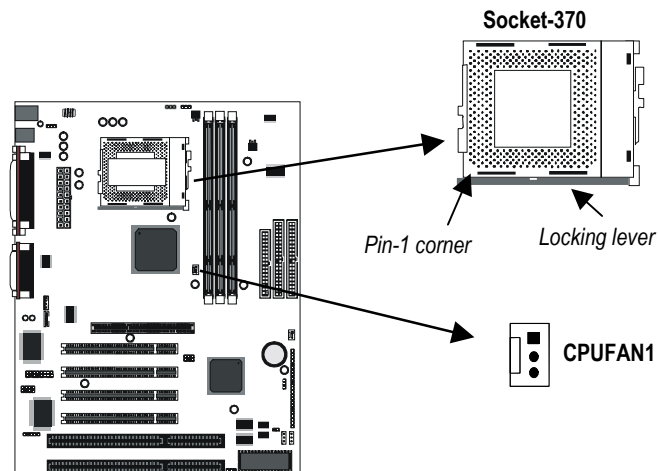

### **Installing a PPGA Celeron in the Socket-370**

This mainboard is installed with a PGA370 ZIF processor socket. This socket will only support the PPGA Celeron processor. *Do not try to insert a socket-7 processor such as a Pentium or Pentium-compatible processor.* The PPGA Celeron processors all run over a 66 MHz system bus and have internal clock speeds ranging from 300 to 433 MHz. Configuration of the processor is made automatically using the mainboard BIOS (see the Setup chapter).

1. Locate the zero insertion force (ZIF) PGA370 socket for the processor.
2. On the socket and on the processor, identify the pin 1 corner. On the socket, the pin-1 corner is opposite the hinge of the locking lever, and it has one hole missing from the corner. On the processor, the pin-1 corner has a slight bevel.

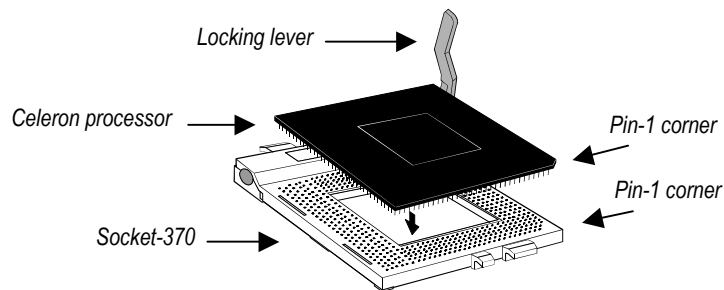

3. Push the socket locking lever away from the socket to unhook it. Swing the lever into the upright position.
4. Insert the processor into the socket taking care that you have matched the pin 1 corners. No force is required, and the processor should seat smoothly into the socket.
5. Swing the locking lever down and hook it under the latch on the side of the socket to lock it in place.
6. Locate the power connector for the processor cooling fan CPU FAN1. If your processor has a cooling fan installed, connect the cable from the cooling fan to CPU FAN1.

## ***Install the Memory Modules***

For this mainboard, you must use 168-pin 3.3V non-buffered Dual In-line Memory Modules (DIMMs). The memory chips must be standard or registered SDRAM (Synchronous Dynamic Random Access Memory). The memory bus can run at 66 MHz , 100 MHz or 133MHz. If your processor operates over a 100 MHz system bus, you must install PC-100 or PC133 memory that also operates over a 100 MHz bus. If you install a processor that operates over a 66 MHz bus, you can install memory chips that operate at 66 MHz.

You must install at least one memory module and the first memory module should be installed in slot DIMM1, the second in slot DIMM2 and the third in slot DIMM3. If the modules use standard SDRAM, the maximum capacity of each module is 128MB. If the modules use registered SDRAM, the maximum capacity is 256MB

The mainboard supports memory chips that have EC (Error Correction) or ECC (Error Correction Code). If you install more than one module, the modules can have different capacities, but the memory chips should all be the same type.

1. Locate the DIMM slots on the mainboard.

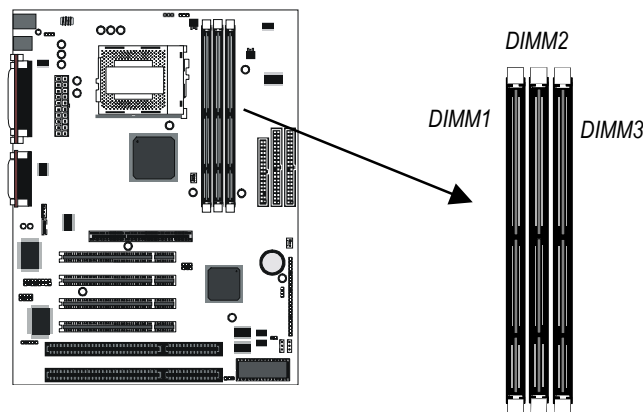

2. The DIMM slots are keyed with notches and the DIMMs are keyed with cut-outs so that they can only be installed correctly. Check that the cut-outs on the DIMM module edge connector match the notches in the DIMM slot.

3. Push the latches on each side of the DIMM slot down.
4. Install the DIMM module into the slot and press it carefully but firmly down so that it seats correctly. The latches at either side of the slot will be levered upwards and latch on to the edges of the DIMM when it is installed correctly.

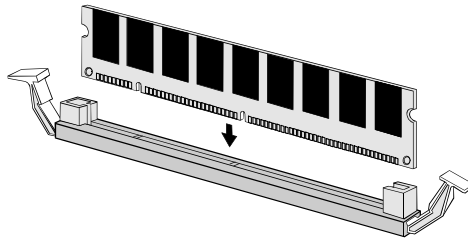

## Check all the Jumper Settings

Check all the mainboard jumpers to ensure that the board is configured correctly.

### A Note on Jumpers

A jumper consists of two or more pins mounted on the mainboard. Some jumpers might be arranged in a series with each pair of pins numbered differently. Jumpers are used to change the electronic circuits on the mainboard. When a jumper cap is placed on two jumper pins, the pins are SHORT. If the jumper cap is removed (or placed on just a single pin) the pins are OPEN.

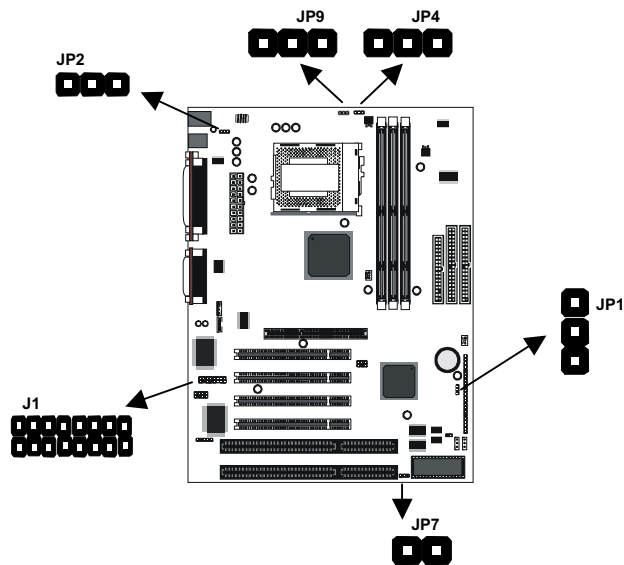
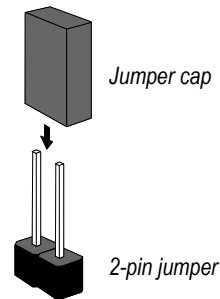



### **JP1: Clear CMOS Memory Jumper**

This jumper lets you erase the system setup settings that are stored in CMOS memory. You might need to erase this data if incorrect settings are preventing your system from operating. To clear the CMOS memory, turn off the system, disconnect the power cable from the mainboard, and short the appropriate pins for a few seconds.

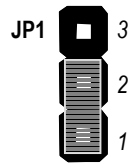

Function	Jumper Cap
Normal Operation	Short pins 1-2
Clear CMOS	Short pins 2-3

### **JP2: Keyboard Power On Jumper**

This jumper lets you use a typed-in password as a power switch to turn your system on. If you enable this property, you need to define the password or the hot keys using the setup utility. See Chapter 3 for more information.

Function	Jumper Cap
Disable keyboard power on	Short pins 1-2
Enable keyboard power on	Short pins 2-3

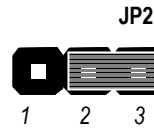

### **JP4: 100MHz System Bus Frequency Select Jumper**

Use this 3-pin jumper to set the system bus frequency. In the normal setting, the system automatically selects the correct frequency according to the kind of processor installed. In the Force 100 MHz setting, the system uses a 100 MHz system bus even if the processor is designed to operate with a 66 MHz bus.

Function	Jumper Cap
Normal	Short pins 1-2
Force 100 MHz	Short pins 2-3

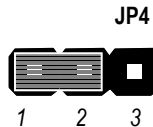

### **JP7: Flash BIOS Enable/Disable Jumper**

The mainboard BIOS is stored on an Erasable Programmable Read Only Memory (EPROM) chip. This means that you can erase the current BIOS and install an updated BIOS whenever new upgrades are released. See Chapter 4 for information on using the Flash BIOS utility. Before erasing the old BIOS and flashing a new BIOS, you must set JP7 to Enable. After the new BIOS is installed, set JP7 to Disable so that the BIOS cannot be erased by accident.

Function	Jumper Cap
Enable flash BIOS	Short pins 1-2
Disable flash BIOS	Open pins 2-3

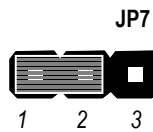

### **JP9: 133MHz System Bus Frequency Select Jumper**

Use this 3-pin jumper to set the system bus frequency. In the normal setting, the system automatically selects the correct frequency according to the kind of processor installed. In the Force 133 MHz setting, the system uses a 133 MHz system bus even if the processor is designed to operate with a 100 MHz bus.

Function	Jumper Cap
66/100MHz	Short pins 1-2
133MHz	Short pins 2-3

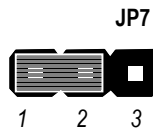

**Note:** When both JP4 and JP9 have the 2-3 pins shorted, the board is set to force a 66 MHz FSB processor to run on a 133 MHz system bus.

### ***J1: Fax/modem Extension Bracket***

The fax/modem extension bracket is supplied with this mainboard.

1. Locate the J1 fax/modem connector on the mainboard.
2. Remove the expansion slot blanking plate from the system chassis that is adjacent to the fax/modem connector.
3. Install the fax/modem extension bracket on to the MDM1 connector as shown below. The RJ11 Line and Telephone sockets on the bracket are positioned in the expansion slot with the removed blanking plate.

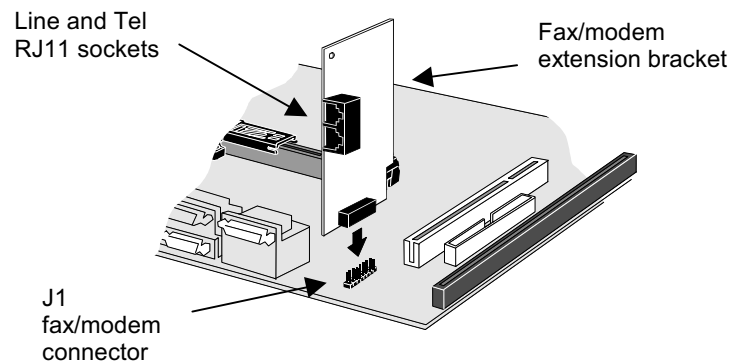

## Install the Mainboard in the System Case

---

Use the screws and mounting brackets supplied with your system case to install the mainboard. Follow the instructions provided by the case manufacturer.

### Connect Devices, Switches and Indicators

**Note:** You might not need to carry out every step in the following procedure. It depends on the options you are installing, and the features that are supported by your system case.

**Note:** Ribbon cable connectors are usually keyed so that they can only be installed correctly on the device connector. If the connector is not keyed make sure that you match the pin-1 side of the cable connector with the pin-1 side of the device connector. Each connector has the pin-1 side clearly marked. The pin-1 side of each ribbon cable is always marked with a red stripe on the cable.

#### IDE & FDD Drives

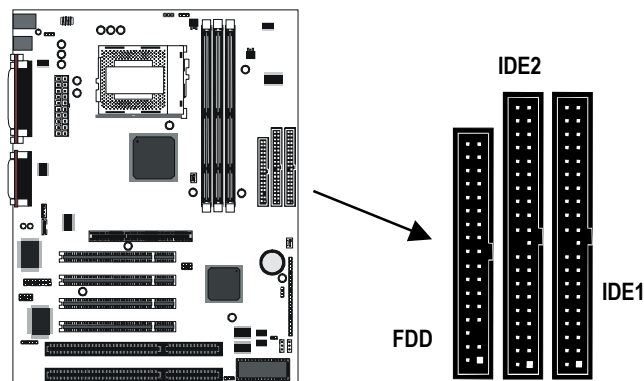

1. Locate the floppy diskette drive connector FDD1. Use the ribbon cable to connect one or two floppy diskettes to the mainboard.
2. Locate the Enhanced IDE connectors IDE1 (primary) and IDE2 (secondary). A single IDE cable is provided with the mainboard. Connect the cable to IDE1. The cable has two connectors for IDE devices. If you connect two devices, you must configure one device

as Master, and one device as Slave. See the documentation provided with the devices for information on this. To install more drives, use another IDE cable and connect one or two devices to IDE2.

**Power Connector, Panel Connector & Case Fan**

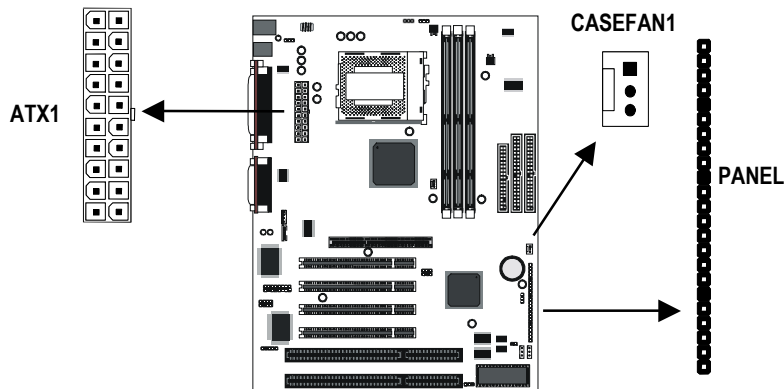

1. Locate the power connector ATX1. Connect the power cable from the power supply unit to ATX1. The connector is keyed so that it can only be installed correctly.
2. If your system case has a built-in cooling fan, you can supply power to the fan from the case fan power connector CASEFAN1. Connect the power cable from the fan to CASEFAN1.
3. Locate the bank of switch and indicator connectors PANEL. These connectors provide control functions to your system case. Use the illustration on the right and the table below to make the connections.

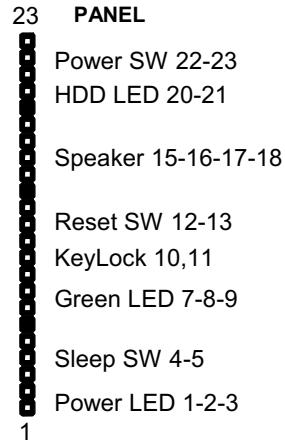

Function	Pins
Power Indicator	1+, 2+, 3
Sleep Switch	4, 5
Green Indicator	7+, 8+, 9
Keylock	10, 11
Reset Switch	12, 13
Speaker	15+, 16, 17, 18
Hard Disk Indicator	20+, 21
Power Switch	22+, 23

## Audio Connectors & Infrared Connector

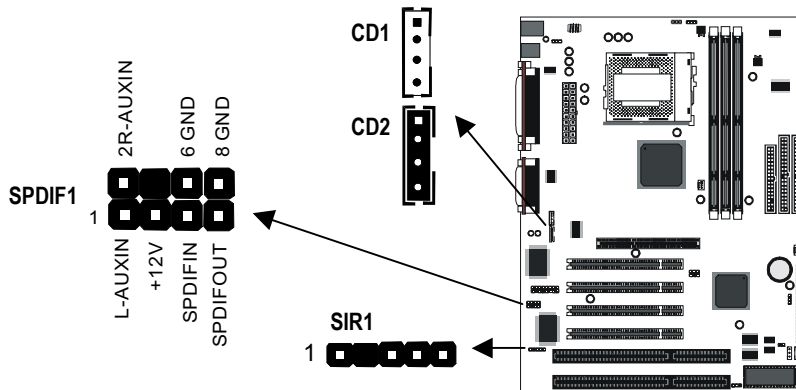

1. If you want to install an optional Serial Infrared Port, connect the cable from the optional IR port to the SIR1 connector on the mainboard.

**Note:** An infrared port (SIR1) and a second serial port (COM2) share the same resources. If you install both of these options, you cannot use them both at the same time. Use the setup utility to configure the system to use either the infrared port or the second serial port. See Chapter 3 for more information.

2. The mainboard has three audio connectors. CD1 is a 4-pin audio connector which can be used to input the audio from a CD-ROM or DVD drive. CD2 is exactly the same, except that it supports an alternative kind of connector. Use either CD1 or CD2 to connect your CD/DVD drive audio output. If you have installed a device which supports 24-bit SPDIF digital audio, you can connect the device to the SPDIF input/output connector SPDIF1.

## Expansion Slots

You can use the expansion slots to install expansion boards that add new features to your system. You must install a graphics adapter in order to use the system.

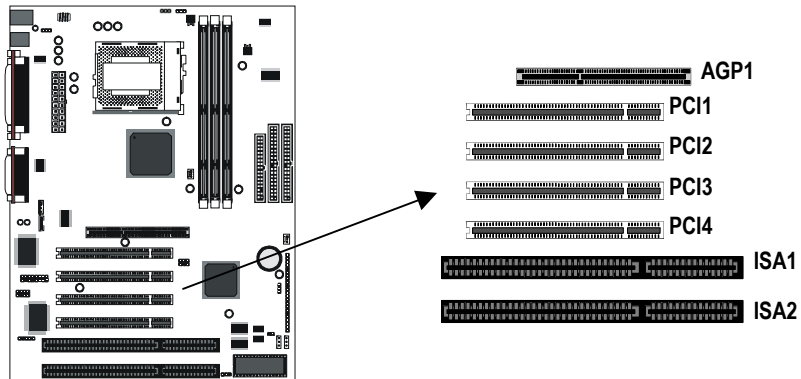

1. The AGP slot can be used by a graphics adapter with an AGP edge connector. This mainboard must be installed with a graphics adapter. You do not need to use an AGP adapter. You can also install a graphics adapter in a PCI slot or even an ISA slot.
2. If you have 32-bit PCI expansion cards, install them in one of the four PCI slots. If you have 8/16-bit legacy ISA cards, you can install them in one of the two ISA slots.

**Note:** The PCI slot PCI4 and the ISA slot ISA1 are shared slots. This means that you can use either one of these slots, but not both of them at the same time. The two slots correspond to the same expansion card opening in the system case.

3. When you install an expansion card, remove the blanking plate from the case expansion card opening that corresponds to the expansion slot on the mainboard. Fit the bracket of the expansion card into the expansion card opening and secure it in place with a screw.

### Wake-Up Connectors and SB-Link

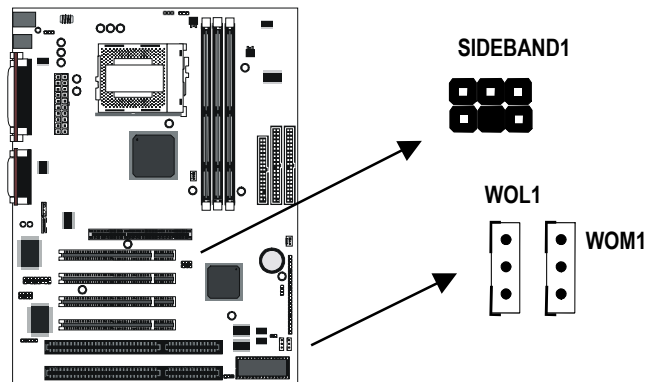

1. The mainboard has wake up connectors for an optional network adapter or an optional internal fax/modem card. If you have installed a network adapter expansion card, connect it to the wake on LAN connector WOL1. If you have installed an internal fax/modem expansion card, connect it to the wake on modem connector WOM1.
2. If you have installed a Sound Blaster PCI audio expansion card, you can connect it to the SB-Link connector SIDEBAND1. SB-Link solves some of the problems that can occur with the audio system when you play legacy DOS real-mode games with a PCI Sound Blaster.



## Make the External Connections

---

After you have installed the mainboard, make the connections to the external ports.

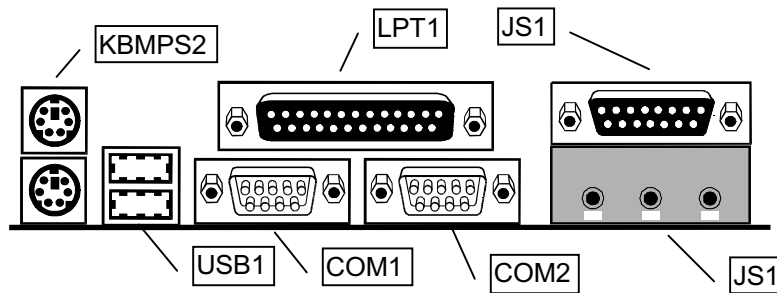

1. KBMPS2 is a stack of two PS/2 mini-DIN ports. The upper port can be used by a PS/2 mouse or pointing device. The lower port can be used by a PS/2 keyboard.
2. LPT1 is a parallel port that can be used by printers or other parallel communications devices. The system identifies the parallel port as LPT1.
3. The upper 15-pin port JS1 is a game/MIDI port. You can use this port to connect a joystick or a MIDI device to your system.
4. The lower part of JS1 is three audio jacks. The left side jack is for a stereo line out signal. The middle jack is for a stereo line in signal. The right side jack is for a microphone.
5. COM2 is a serial port that can be used by serial devices such as a mouse, a fax/modem and so on. This serial port is identified by the system as COM2/4.
6. COM1 is a serial port that can be used by serial devices such as a mouse, a fax/modem and so on. This serial port is identified by the system as COM1/3.
7. USB1 is a stack of two Universal Serial Bus ports. Use these ports to connect to USB devices.

## Chapter 3: Setup

### About the Setup Utility

---

This chapter explains how to use and modify the BIOS setup utility that is stored on the mainboard. The setup utility stores information about the mainboard components, and the configuration of other devices that are connected to it. The system uses this information to test and initialize components when it is started up, and to make sure everything runs properly when the system is operating.

The setup utility is installed with a set of default values. The default values are designed to ensure that the system will operate adequately. You will probably have to make changes to the setup utility whenever you add new components to your system such as new disk drives. You may be able to generate increased performance by changing some of the timing values in the setup, but this can be limited by the kind of hardware you are using, for example the rating of your memory chips. In certain circumstances, the system may generate an error message which asks you to make changes to the setup utility. This happens when the system finds an error during the POST (power on self test) that it carries out at start up.

#### ***Starting the Setup Utility***

You can only start the setup utility shortly after the computer has been turned on. A prompt appears on the computer display which says “*Press DEL to run Setup*”. When you see this prompt, press the **Delete** key, and the system will start the setup utility and display the main menu of the utility.

#### ***Using the Setup Utility***

When you press the **Delete** key to start setup, the main menu of the utility appears.

The main menu of the setup utility shows a list of the options that are available in the utility. A highlight shows which option is currently selected. You can use the cursor arrow keys to move the highlight to other options. When an option is highlighted, you can execute the option by pressing the **Enter** key.

Some options lead to dialog boxes which ask you verify that that you wish to execute that option. You usually answer these dialogs by typing **Y** for yes and **N** for no.

Some options lead to dialog boxes which ask for more information. Setting the User Password or Supervisor Password have this kind of dialog box.

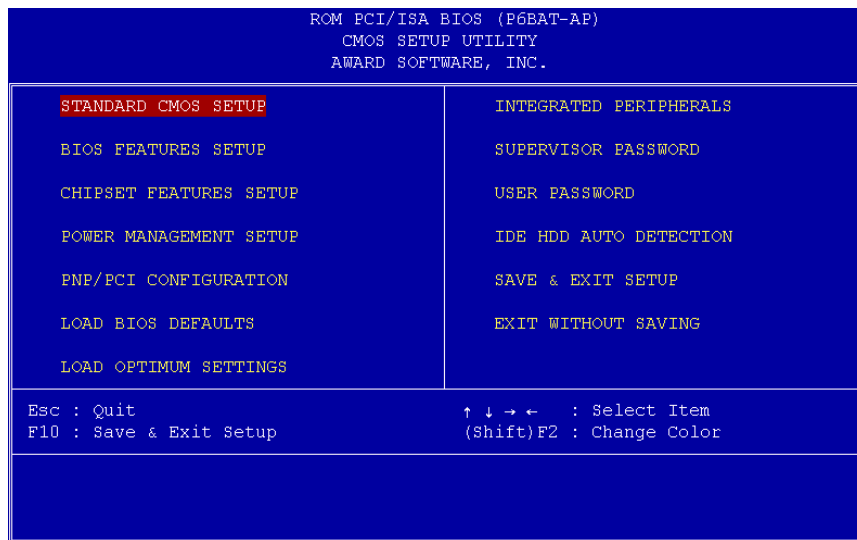

Some options lead to tables of items. These items usually have a value on the right side. The value of the first item is highlighted, and you can use the cursor arrow keys to select any of the other values in the table of items. When an item is highlighted, you can change the value by pressing the **PageUp** or **PageDown** keys, or the **Plus** or **Minus** keys. The **PageUp** and **Plus** keys cycle forward through the available values, the **PageDown** and **Minus** keys cycle backwards through the values.

When you are in the main menu, you can exit the utility by pressing the **Escape** key. You can save the current selections and exit the utility by pressing the **F10** key. You can change the color scheme of the utility by pressing the **F2** key while holding down the **Shift** key.

When you are in one of the options that displays a dialog box, you can return to the main menu by pressing the **Escape** key.

When you are in one of the options that displays a table of items, you can return to the main menu by pressing the **Escape** key. For some items, you can display a help message by pressing the **F1** key. You can change the color scheme of the utility by pressing the **F2** key while holding down the **Shift** key. You can press **F5** to discard any changes you have made and return all items to the value that they held when the setup utility was started. You can press **F6** to load the displayed items with a standard list of default values. You can press **F7** to load the displayed items with a high-performance list of default values.

## Standard CMOS Setup Option

This option displays a table of items which defines basic information about your system.

```

ROM PCI/ISA BIOS (P6BAT-AP)
STANDARD CMOS SETUP
AWARD SOFTWARE, INC.

Date (mm:dd:yy) : Tue, Mar 30 1999
Time (hh:mm:ss) : 15 : 4 : 50

HARD DISKS          TYPE      SIZE  CYLS  HEAD  PRECOMP  LANDEZ  SECTOR  MODE
-----
Primary Master   :    0      0      0    0      0      0      0    0 NORMAL
Primary Slave   :    0      0      0    0      0      0      0    0 NORMAL
Secondary Master :    0      0      0    0      0      0      0    0 NORMAL
Secondary Slave  :    0      0      0    0      0      0      0    0 NORMAL

Drive A : None
Drive B : None
Floppy 3 Mode Support : Disabled

Video : EGA/VGA
Halt On : All Errors

ESC : Quit          ↑ ↓ → ← : Select Item      PU/PD/+/- : Modify
F1  : Help          (Shift)F2 : Change Color

```

### **Date and Time**

The Date and Time items show the current date and time held by your computer. If you are running a Windows operating system, these items will automatically be updated whenever you make changes to the Windows Date and Time Properties utility.

---

**Hard Disks****Defaults: Auto**

These items show the characteristics of any hard disk drives on the four available IDE channels. (Note that SCSI hard disk drives do not appear here.) You can automatically install most modern hard disks using the IDE HDD Auto Detect Option from the main menu. However, if you find that a drive cannot be automatically detected, you can use these items to select USER, and then manually enter the characteristics of the drive. The documentation provided with your drive provides the data you need to fill in the values for CYLS (cylinders), HEAD (read/write heads), and so on.

The documentation provided with the drive may not tell you what value to use under the MODE heading. If the drive is smaller than 528 MB, set MODE to Normal. If the drive is larger than 528 MB and it supports Logical Block Addressing, set MODE to LBA. Very few high-capacity drives do not support Logical Block Addressing. If you have such a drive, you might be able to configure it by setting the MODE to Large. If you're not sure which MODE setting is required by your drive, set MODE to Auto and let the setup utility try to determine the mode automatically.

---

**Drive A and Drive B****Default: None , None**

These items define the characteristics of any diskette drive attached to the system. You can connect one or two diskette drives.

---

**Floppy 3 Mode Support****Default: Disabled**

Floppy 3 mode refers to a 3.5" diskette with a capacity of 1.2 MB. Floppy 3 mode is sometimes used in Japan.

---

**Video****Default: EGA/VGA**

This item defines the video mode of the system. This mainboard has a built-in VGA graphics system so you must leave this item at the default value.

---

**Halt On****Default: All Errors**

This item defines the operation of the system POST (Power On Self Test) routine. You can use this item to select which kind of errors in the POST are sufficient to halt the system.

---

**Base, Extended and Other Memory.**

These items show how much memory is available on the system. They are automatically detected by the system so you cannot manually make changes to these items.

---

## BIOS Feature Setup Option

---

This option displays a table of items which defines more advanced information about your system. You can make modifications to most of these items without introducing fatal errors to your system.

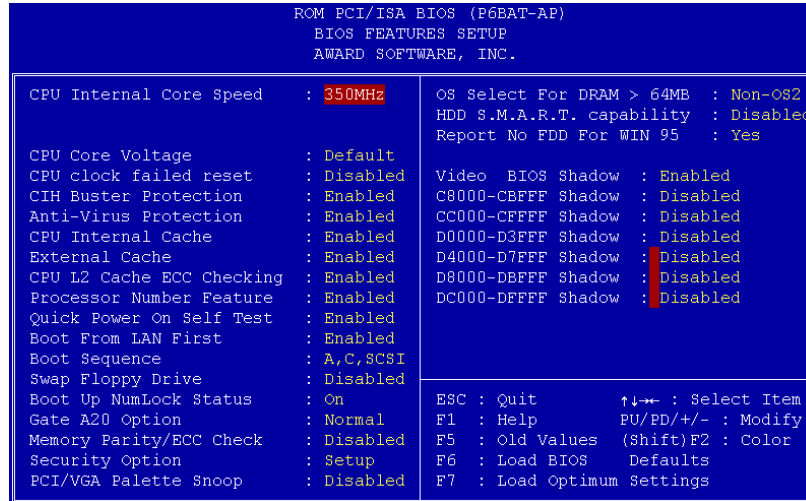

---

**CPU Internal Core Speed**                      **Default: 350MHz**

This item should be installed with the rated internal core speed of the Pentium-II class processor that is installed in your system. The setup utility will then automatically configure the system with the correct host bus speed, and bus frequency multiplier.

If you set this item to Manual, two new items will appear: *CPU Host BUS Frequency* and *CPU Core:Bus Freq. Multiple*. You can use these two items to manually configure the mainboard for the speed of the processor. The values available in these two items will vary, according to the kind of Pentium-II processor that is installed.

**Note:** *Using the three items above, you can configure the mainboard so that it runs a processor faster than the rated clock speed. We strongly recommend that you do not overclock the processor. Overclocking can introduce excess heat, recurring instability, or even complete failure in your system.*

---

**CPU Core Voltage**                                      **Default: Default**

This item can be used to set a core voltage for different kinds of processors. Leave this item at the default value and your system will automatically assign the correct voltage.

---

**CPU Clock Failed Reset**                              **Default: Disabled**

If this item is enabled, and your system crashes three times because you have overclocked the processor, this item will automatically adjust the speed of the processor to the system bus speed multiplied by two.

---

**CIH Buster Protection** **Default: Enabled**  
**Anti-Virus Protection** **Default: Enabled**

When "CIH Buster Protection" item is enabled it provided some protection against viruses which try to destroy BIOS viruses (especially for CIH).

When "Anti-Virus Protection" item is enabled it provides some protection against viruses which try to write to the boot sector and partition table of your hard disk drive. This item is Enabled as a default. You might need to disable it so that you can install an operating system. We recommend that you enable Anti-Virus Protection as soon as you have installed your disk with an OS.

---

**CPU Internal Cache** **Default: Enabled**

All the processors that can be installed in this mainboard use internal (level 1) cache memory to improve performance. Leave this item at the default value Enabled for better performance.

---

**External Cache** **Default: Enabled**

Most of the processor cartridges that can be installed in this mainboard have (level 2) external cache memory (the Celeron-266 MHz is an exception). Only enable this item if your processor cartridge has external cache memory.

---

**CPU L2 Cache ECC Checking** **Default: Enabled**

This item can be used to enable ECC (Error Checking Code) for the level-2 cache memory. We recommend that you leave this item at the default value Enabled.

---

**Processor Number Feature** **Default: Enabled**

Some new procesosrs (the Pentium-III) are installed with a unique procesosr identification number. If you disable this item, the number will be suppressed so that it cannot be read by other systems on the network.

---

**Quick Power On Self Test** **Default: Enabled**

You can enable this item to shorten the power on testing and have your system start up a little faster.

---

**Boot from LAN First** **Default: Enabled**

This items lets you specify that the system will try to load an operating system from a network server first, before booting from any of the local drives.

---

**Boot Sequence** **Default: A, C, SCSI**

This item defines where the system will look for an operating system, and the order of priority. You can boot an operating system from many locations including a SCSI device, a ZIP drive, a floppy diskette drive, or an LS-120 high-capacity diskette drive.

---

**Swap Floppy Drive** **Default: Disabled**

If you have two floppy diskette drives in your system, this item allows you to swap around the assigned drive letters so that drive A becomes drive B, and drive B becomes drive A.

---

**Boot Up NumLock Status** **Default: On**

This item defines if the keyboard Num Lock key is active when your system is started.

---

**Gate A20 Option** **Default: Normal**

This option provides compatibility with older software written for the 286 processor. Leave this item at the default value Normal.

---

**Memory Parity/ECC Check** **Default: Disabled**

This mainboard supports memory modules that have error checking using a parity bit, or using ECC (Error Correction Code). If your memory modules have this function, you can enable this feature for greater reliability.

---

**Security Option** **Default: Setup**

If you have installed password protection, this item defines if the password is required at system start up, or if it is only required when a user tries to enter the setup utility.

---

**PCI/VGA Palette Snoop** **Default: Disabled**

This item can help overcome problems that are caused by some non-standard VGA cards. We recommend that you leave this item at the default value Disabled.

---

**OS Select For DRAM > 64 MB** **Default: Non-OS2**

This item is required if you have installed more than 64 MB of memory and you are running the OS/2 operating system. Otherwise, leave this item at the default Non-OS2

---

**HDD S.M.A.R.T Capability** **Default: Disabled**

S.M.A.R.T is an industry acronym for Self-monitoring, Analysis and Reporting Technology. If the documentation of your hard disk states that S.M.A.R.T. is supported, you can enable this item.

---

**Report No FDD For WIN 95** **Default: Yes**

When the item is enabled, the IRQ-6 can be reserved for another device if you don't install FDD.

---

**Video BIOS Shadow** **Default: Enabled**

This item allows the video BIOS to be copied to system memory for faster performance.

---

**XXXXX-XXXXX Shadow** **Default: Disabled**

These items allow the BIOS of other devices to be copied to system memory for faster performance.

---

## Chipset Features Option

---

This option displays a table of items which define timing parameters of the mainboard components including the graphics system, the memory, and the system logic. In general rule, you should leave the items on this page at the default values unless you are very familiar with the technical



specifications of your hardware. If you change the values, you may introduce fatal errors or recurring instability into your system.

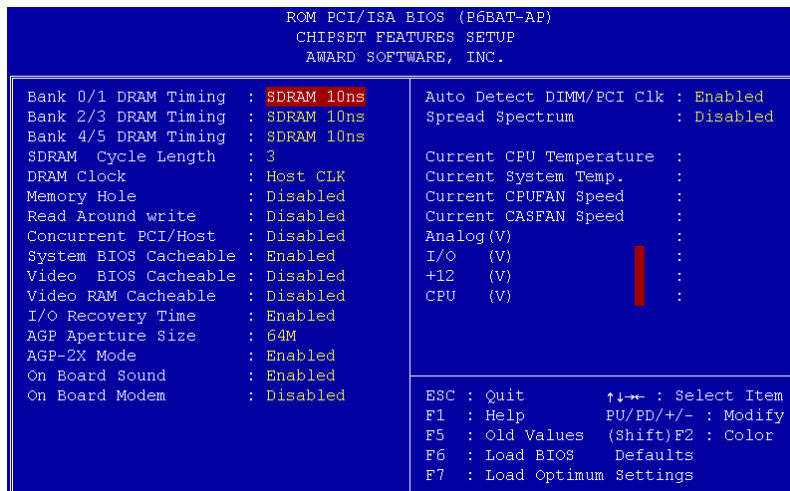

---

<b>Bank 0/1 DRAM Timing</b>	<b>Default: SDRAM 10ns</b>
<b>Bank 2/3 DRAM Timing</b>	<b>Default: SDRAM 10ns</b>
<b>Bank 4/5 DRAM Timing</b>	<b>Default: SDRAM 10ns</b>

These items define the timing parameters for the system memory. We recommend that you leave these items at the default values SDRAM 10ns.

---

<b>SDRAM Cycle Length</b>	<b>Default: 3</b>
---------------------------	-------------------

This item sets the number of CPU cycles between SDRAM refresh. If insufficient time is allowed, refresh may be incomplete and data can be lost. We recommend that you leave this item at the default value.

---

<b>DRAM Clock</b>	<b>Default: Host CLK</b>
-------------------	--------------------------

When this item is enabled, It allows the DRAM to work concurrently with the host bus clock, otherwise, DRAM will work concurrently with AGP clock .

---

<b>Memory Hole</b>	<b>Default: Disabled</b>
--------------------	--------------------------

This item can be used to reserve memory space for some ISA cards that require it. We recommend that you leave this item at the default value Disabled.

---

<b>Read Around write</b>	<b>Default: Disabled</b>
--------------------------	--------------------------

This item optimizes the cache memory. If the system needs to read data from an address in memory, and the write buffer holds fresh data that has not yet been written to that address, the read can be made directly from the write buffer, instead of the address in the main memory.

---

<b>Concurrent PCI/Host</b>	<b>Default: Disabled</b>
----------------------------	--------------------------

This item allows other PCI devices to work concurrently with the host PCI IDE channel. We recommend that you leave this item at the default value Disabled.

---

<b>System BIOS Cacheable</b>	<b>Default: Enabled</b>
<b>Video BIOS Cacheable</b>	<b>Default: Disabled</b>

These items allow the video and/or system to be cached in memory for faster execution. We recommend that you leave these items at the default value.

---

<b>Video RAM Cacheable</b>	<b>Default: Disabled</b>
----------------------------	--------------------------

This item permits the video memory to be cached for faster performance. We recommend that you leave this item at the default value Disabled.

---

<b>I/O Recovery Time</b>	<b>Default: Enabled</b>
--------------------------	-------------------------

When this item is enabled, the ISA command can be extended more than the recovery time default 3.5 SYSCLK . We recommend that you leave this item at the default value.

---

<b>AGP Aperture Size</b>	<b>Default: 64M</b>
--------------------------	---------------------

This item defines the size of the aperture for the Accelerated Graphics Port. The aperture is a portion of the PCI memory address range dedicated for graphics memory address space.

---

<b>AGP-2x Mode</b>	<b>Default: Enabled</b>
--------------------	-------------------------

This item allows the AGP graphics adapter to operate in 2x Mode. We recommend that you leave this item at the default value Enabled.

---

<b>On Board Sound</b>	<b>Default: Enabled</b>
-----------------------	-------------------------

Use this item to enable or disable the sound system that is integrated on this mainboard.

---

<b>On Board Modem</b>	<b>Default: Disabled</b>
-----------------------	--------------------------

Use this item to enable or disable the fax/modem that is integrated on this mainboard.

---

<b>Auto Detect DIMM/PCI Clk</b>	<b>Default: Enabled</b>
---------------------------------	-------------------------

When this item is enabled, it can be used to detect the clock whether you install the DIMM/PCI on your mainboard or not in order to avoid the clock interference.

---

<b>Spread Spectrum</b>	<b>Default: Disabled</b>
------------------------	--------------------------

When this item is enabled, it can significantly reduce the EMI (electrical magnetic interference) that your system generates.

---

**Right Side Items**

The items on the right side of the Chipset Features option are concerned with monitoring certain temperatures, voltages, and so on in your system. These items do not function unless you have installed an optional system monitoring chip on your mainboard.

---

## Power Management Setup Option

---

This option displays a table of items which lets you control the power management of the system. Modern operating systems take care of

much of the routine power management. This mainboard supports ACPI (advanced configuration and power interface).

This system supports three levels of power-saving modes; doze mode, standby mode, and suspend mode. Standby mode uses less power than doze mode and suspend mode uses the least power.

The power management in the setup utility lets you specify a timeout for each of the power-saving modes, and a timeout for a hard disk drive power down. A timeout, means a period of time when the system (or the hard disk drive) is inactive. If the timeout completes, the system power-saving mode will execute, or the hard disk drive will power down. You can resume from the power-saving modes by carrying out any of the activities which are enabled in the list Reload Global Timer Events. If the hard disk has been powered down it will automatically resume to full power when an access to the hard disk is required (this takes just a few seconds).

```

ROM PCI/ISA BIOS (P6BAT-AP)
POWER MANAGEMENT SETUP
AWARD SOFTWARE, INC.

Power Management      : User Define
PM Control by APM     : Yes
Video Off After       : Suspend
Video Off Method      : DPMS Support
MODEM Use IRQ        : 3
Soft-Off by FWRBTN    : Instant-Off
HDD Power Down       : Disable
Doze Mode             : Disable
Suspend Mode         : Disable
** PM Events **
VGA                  : OFF
LPT & COM            : LPT/COM
HDD & FDD           : OFF
DMA/master          : OFF
Resume by Ring/LAN   : Disabled
Resume by Alarm      : Disabled

Primary INTR        : ON
IRQ3 (COM 2)       : Primary
IRQ4 (COM 1)       : Primary
IRQ5 (LPT 2)       : Primary
IRQ6 (Floppy Disk) : Primary
IRQ7 (LPT 1)       : Primary
IRQ8 (RTC Alarm)   : Disabled
IRQ9 (IRQ2 Redir)  : Secondary
IRQ10 (Reserved)   : Secondary
IRQ11 (Reserved)   : Secondary
IRQ12 (PS/2 Mouse) : Primary
IRQ13 (Coprocesor) : Primary
IRQ14 (Hard Disk)  : Primary
IRQ15 (Reserved)   : Disabled

ESC : Quit          ↑↓←→ : Select Item
F1  : Help          PU/PD/+/- : Modify
F5  : Old Values   (Shift)F2 : Color
F6  : Load BIOS    Defaults
F7  : Load Optimum Settings

```

**Power Management** **Default: User Define**

This item acts like a master switch for the power-saving modes and hard disk timeouts. If this item is set to Disabled, all the power-saving modes are disabled. If this item is set to Max Saving, doze, standby, and suspend mode, will occur after a timeout of 20 seconds. If this item is set to Min Saving, doze, standby, and suspend mode will occur after a timeout of 40 minutes. If the item is set to User Define, you can insert your own timeouts for the power-saving modes.

---

**PM Control by APM** **Default: Yes**  
Windows 95 and 98 have built-in power management capabilities called APM (advanced power management). When you enable this item, you allow the APM routines in Windows to operate on your system.

---

**Video Off Option** **Default: Suspend -> Off**  
This option defines which level of power-saving mode is required in order to power down the video display. As a default, the video powers down in suspend mode but not standby mode.

---

**Video Off Method** **Default: DPMS Support**  
This item defines how the video is powered down to save power. As a default, this is set to DPMS Support (display power management software).

---

**Modem Use IRQ** **Default: 3**  
If you would like an incoming call on a modem to automatically resume the system from suspend mode, use this item to specify the interrupt request line (IRQ) that is used by the modem.

---

**Soft-Off by PWRBTN** **Default: Instant-Off**  
Under ACPI (advanced configuration and power interface) the system can be turned off mechanically (by the power button) or it can undergo a software power off. If the system has been turned off by software, the system can be resumed by a LAN, MODEM or ALARM wake up signal. This item allows you to define a software power off using the power button. If the value is set to Instant-Off, the power button will automatically cause a software power off. If the value is set to Delay 4 Sec. the power button must be held down for a full four seconds to cause a software power off.

---

**HDD Power Down** **Default: Disabled**  
You can use this item to set a timeout for a hard disk powerdown. You can set a time from 1 to 15 minutes. If the hard disk is inactive for the time specified, it will power down. It will automatically return to full power when it is next accessed.

---

**Doze Mode** **Default: Disabled**  
If you have selected User Define for the Power Management item, you can set this item to a selection of timeouts from 20 seconds to 40 minutes.

---

**Suspend Mode** **Default: Disabled**  
If you have selected User Define for the Power Management item, you can set this item to a selection of timeouts from 20 seconds to 40 minutes.

---

**VGA** **Default: OFF**  
When this item is enabled, any activity on the graphics system can reset power-saving mode timeouts to zero, or resume the system from a power saving mode.

---

**LPT & COM** **Default: LPT/COM**  
When this item is enabled, it defines system activities which can reset power-saving mode timeouts to zero, or resume the system from a power saving mode. This item is for transmissions through the serial or parallel ports.

---

**HDD & FDD****Default: ON**

When this item is enabled, it defines system activities which can reset power-saving mode timeouts to zero, or resume the system from a power saving mode. This item is for hard disk and/or diskette drive activity.

---

**DMA/master****Default: OFF**

When this item is enabled, it defines system activities which can reset power-saving mode timeouts to zero, or resume the system from a power saving mode. This item is activity through the system DMA controller.

---

**Wake Up On LAN****Default: Enabled**

This item allows you to enable or disable the LAN wake up function that is a feature of this mainboard. When enabled, traffic through a network will resume the system from any of the power-saving modes.

---

**Modem Ring Resume****Default: Disabled**

This item allows you to enable or disable the modem wakeup function that is a feature of this mainboard. When enabled, traffic through a fax/modem will resume the system from any of the power-saving modes.

---

**RTC Alarm Resume****Default: Disabled**

This item lets you install a wakeup alarm, which resumes the system from a power saving mode at a fixed date and time. When the item is enabled, new items appear which allow you to set the date and time of the alarm.

---

**Primary INTR****Default: On**

This item acts like a master switch for all the interrupt items that follow. If this item is set to ON, the all the following interrupts can be manually configured to act as resets for the power saving timeouts. If this item is set to OFF, then all the following interrupt items cannot be used to reset the power saving timeouts.

---

**IRQX**

These interrupt events can act as triggers to reset the power saving timeouts or other system maintenance tasks. If you set an interrupt event to Primary, any activity on that interrupt will reset the timeouts that use the primary timer (e.g. the power saving modes). If you set an interrupt to Secondary, then any activity on the interrupt will reset those timeouts that use the secondary timer (usually background maintenance tasks). If you set an interrupt event to Disabled, any activity on the interrupt will not reset the timeouts.

---

## PNP/PCI Configuration Option

---

This option displays a table of items that configures how PNP (Plug and Play) and PCI expansion cards operate in your system.

```

ROM PCI/ISA BIOS (P6BAT-AP)
PNP/PCI CONFIGURATION
AWARD SOFTWARE, INC.

PNP OS Installed      : No
Resources Controlled By : Manual
Reset Configuration Data : Disabled

IRQ-3 assigned to : PCI/ISA PnP
IRQ-4 assigned to : PCI/ISA PnP
IRQ-5 assigned to : Legacy ISA
IRQ-7 assigned to : PCI/ISA PnP
IRQ-9 assigned to : PCI/ISA PnP
IRQ-10 assigned to : PCI/ISA PnP
IRQ-11 assigned to : PCI/ISA PnP
IRQ-12 assigned to : PCI/ISA PnP
IRQ-14 assigned to : PCI/ISA PnP
IRQ-15 assigned to : PCI/ISA PnP
DMA-0 assigned to : PCI/ISA PnP
DMA-1 assigned to : PCI/ISA PnP
DMA-3 assigned to : PCI/ISA PnP
DMA-5 assigned to : PCI/ISA PnP
DMA-6 assigned to : PCI/ISA PnP
DMA-7 assigned to : PCI/ISA PnP

CPU to PCI Write Buffer: Enabled
PCI Dynamic Bursting : Enabled
PCI Master 0 WS Write : Enabled
PCI Delay Transaction : Enabled
PCI#2 Access #1 Retry : Disabled
AGP Master 1 WS Write : Enabled
AGP Master 1 WS Read : Disabled

Assign IRQ For USB : Enabled
Assign IRQ For VGA : Enabled

ESC : Quit      ↑↓←→ : Select Item
F1 : Help      PU/PD/+- : Modify
F5 : Old Values (Shift)F2 : Color
F6 : Load BIOS Defaults
F7 : Load Optimum Settings

```

---

**PNP OS Installed** **Default: No**

If you have installed a Plug and Play operating system such as Windows 95 or 98, you can change this item to Yes. When the item is set to Yes you can use the Device Manager utility in the operating system to make changes to the configuration of expansion cards.

---

**Resources Controlled By** **Default: Manual**

You should leave this item at the default Manual. If you find that you cannot get a particular expansion card to work properly, you might be able to solve the problem by changing this item to Manual, and defining the characteristics of the card in the new items which appear.

In the default Manual, the display will list a series of items that allow you to define the assignments of the system interrupt lines (IRQs) and Direct Memory Access (DMA) channels. As a default, these items are set to PCI/ISA PnP. If you install an ISA-bus card that does not support PNP, and it requires a special IRQ and DMA, you can modify the list of assignments. Change the values of the IRQ and DMA that are required to Legacy ISA.

---

**Reset Configuration Data** **Default: Disabled**

If you enable this item and restart the system, any PNP configuration data stored in the BIOS setup will be cleared from memory. New updated configuration data will be created.

---

**Assign IRQ for USB** **Default: Enabled**

When this item is enabled, the system will assign an IRQ to the USB ports.

## **Load BIOS Defaults Option**

---

This option displays a dialog box which allows you to install BIOS defaults for all appropriate items in the whole setup utility. Press the **Y** key and then the **Enter** key to install the defaults. Press the **N** key and then **Enter** to not install the defaults. The BIOS defaults do not place great demands on the system and are generally very stable. If your system is not running correctly, you might like to install the BIOS defaults as a first step in getting your system working properly again. If you only want to install BIOS defaults for a specific option, select and display the option, and press the **F6** key.

## **Load Setup Defaults Option**

---

This option displays a dialog box which allows you install setup defaults for all appropriate items in the whole setup utility. Press the **Y** key and then the **Enter** key to install the defaults. Press the **N** key and then **Enter** to not install the defaults. The setup defaults can place some demands on the system that are greater than the performance level of the components, such as the processor and the memory. You could cause fatal errors or recurring instability if you install the optimum defaults when your hardware does not support it. If you only want to install optimum settings defaults for a specific option, select and display that option, and then press the **F7** key.

## **Integrated Peripherals Option**

---

This option displays a list of items which defines the operation of some peripheral items on the system's input/output ports.





---

<b>IDE Primary Master UDMA</b>	<b>Default: Auto</b>
<b>IDE Primary Slave UDMA</b>	<b>Default: Auto</b>
<b>IDE Secondary Master UDMA</b>	<b>Default: Auto</b>
<b>IDE Secondary Slave UDMA</b>	<b>Default: Auto</b>

---

Each IDE channel supports a master device and a slave device. This motherboard supports UltraDMA. UltraDMA technology provides faster access to IDE devices. If you install a device which supports UltraDMA, change the appropriate item on this list to Auto. You may have to install the UltraDMA driver supplied with this motherboard in order to use an UltraDMA device.

---

<b>Init Display First</b>	<b>Default: PCI Slot</b>
---------------------------	--------------------------

---

Use this item to define if your graphics adapter is installed in one of the PCI slots, or if you have installed an AGP graphics adapter into the AGP slot.

---

<b>Power On Function</b>	<b>Default: Hot KEY</b>
<b>KB Power ON Password</b>	<b>Default: [Enter]</b>
<b>Hot Key Power ON</b>	<b>Default: Ctrl-F12</b>

---

The Power On Function item allows you to power on the system by pressing hot-keys, or typing in a password. If you choose Password, you can use the item KB Power On Password to install a power on password. If you set this item to Hot Key, you can then use the item Hot Key Power On to choose which hot keys are installed.

---

<b>KBC input clock</b>	<b>Default: 8 MHz</b>
------------------------	-----------------------

---

This item lets you set a frequency for the input clock of the keyboard controller. Leave this item at the default value 8 MHz.

---

<b>Onboard FDC Controller</b>	<b>Default: Enabled</b>
-------------------------------	-------------------------

---

This item enables or disables the floppy diskette drive controller built into this mainboard.

---

<b>Onboard Serial Port 1</b>	<b>Default: 3F8/IRQ4</b>
------------------------------	--------------------------

---

This item lets you disable the built-in serial port 1, or enable it by assigning an I/O address and an Interrupt Request Line (IRQ).

---

<b>Onboard Serial Port 2</b>	<b>Default: 2F8/IRQ3</b>
------------------------------	--------------------------

---

This item lets you disable the built-in serial port 2, or enable it by assigning an I/O address and an Interrupt Request Line (IRQ).

---

<b>UART Mode Select</b>	<b>Default: Normal</b>
-------------------------	------------------------

---

This item defines the operation of serial port 2. In the default Normal setting, serial port 2 is assigned to the connector on the mainboard. If you have installed an optional infrared port, you must change the setting of this item to either IrDA, or ASKIR. These settings will disable the mainboard serial port connector and assign serial port 2 to the infrared device. IrDA prepares the port to receive infrared communications using the IrDA serial infrared standard. ASKIR prepares the port to receive infrared communications using the ASK serial infrared standard. The ASK standard is supported by many devices made by the Sharp Corporation. If you have selected an IR mode, you can use the following two items RxD, TxD Active, and IR transmission delay to set the parameters of the

infrared port. See the documentation for the infrared port for information on these items.

---

**UART2 Duplex Mode** **Default: Half**

This item lets you choose two types Half Duplex/Full Duplex Duplex Mode.

---

**Onboard Parallel Port** **Default: 378/IRQ7**

This item lets you disable the built-in parallel port, or enable it by assigning an I/O address and an Interrupt Request Line (IRQ).

---

**Parallel Port Mode** **Default: ECP + EPP**

This item defines the operation of the parallel port. As a default it is set to ECP + EPP. If you are connected to a parallel device that supports the higher-performance EPP (enhanced parallel port) or the ECP (extended capabilities port) make the appropriate changes to this item. If you change the parallel port to EPP or ECP, new items appear that let you configure the EPP and ECP modes.

---

**PWRON After PWR-Fail** **Default: Off**

If this item is enabled, system will automatic power on when power come back after power lost

---

**OnChip USB** **Default: Enabled**

This mainboard has a built-in USB (universal serial bus) port so you should leave this item at the default value Enabled.

---

**USB Keyboard Support** **Default: Disabled**

If you connect a USB keyboard to your system, enable this item.

---

## Supervisor Password and User Password

---

These two items can be used to install a Supervisor Password and a User Password. If you log on as Supervisor, you have full access to the system, and you can restrict the permissions granted to someone who logs on as User. For example, a Supervisor can restrict a User from entering the setup utility.

To install a Supervisor or User Password, follow these steps:

1. Highlight the item Supervisor/User password on the main menu and press **Enter**.
2. The password dialog box will appear.
3. If you are installing a new password, carefully type in the password. You cannot use more than 8 characters or numbers. The password will differentiate between upper case and lower characters. Press **Enter** after you have typed in the password. If you are deleting a password that is already installed just press **Enter** when the password dialog box appears.

4. The system will ask you to confirm the new password by asking you to type it in a second time. Carefully type the password again and press **Enter**, or just press **Enter** if you are deleting a password that is already installed.
5. If you typed the password correctly, the password will be installed.

## **IDE HDD Auto Detection Option**

---

This item automatically detects and installs any hard disk drives installed on the primary and secondary IDE channel. Most modern drives can be detected. If you are using a very old drive that can't be detected, you can install it manually using the Standard CMOS Setup option.

Setup will check for two devices on the primary IDE channel and then two devices on the secondary IDE channel. At each device, the system will flash an **N** in the dialog box. Press **Enter** to skip the device and proceed to the next device. Press **Y**, then **Enter** to tell the system to auto-detect the device.

## **Save And Exit Setup Option**

---

Highlight this item and press **Enter** to save the changes that you have made in the setup utility and exit the setup program. When the *Save and Exit* dialog box appears, press **Y** to save and exit, or press **N** to return to the setup main menu.

## **Exit Without Saving Option**

---

Highlight this item and press **Enter** to discard any changes that you have made in the setup utility and exit the setup program. When the *Exit Without Saving* dialog box appears, press **Y** to discard changes and exit, or press **N** to return to the setup main menu.

## Chapter 4: Software

### About the Software

---

The software for this mainboard is supplied on a CD-ROM. The disk has some folders that can be used by many different mainboards, for example the **UTILITY** and **PERIPHERAL** folders. Some folders can only be used by mainboards which have certain brands of chipsets, for example the **INTEL** and **VIA** folders. In addition, software that is specifically intended for one kind of mainboard is stored in a folder with the name of that board. The folder for this mainboard is stored in the **P6BAP-A+** folder.

***Note:** Never try to install software from a folder that is not specified for use with your mainboard.*

### Folders for this Mainboard

---

For this board, you can install software from the following folders:

#### **Utility Folder**

You can use the software in the following sub-folders:

- AWDFLASH:** Software to erase and install new revisions of the system BIOS
- DIRECTX5:** Software display drivers for Microsoft's DirectX Rev. 5 specification
- PC-CILLIN:** Anti-virus software
- BITWARE:** Software for the built-in fax/modem
- GAMUT:** Audio rack for built-in sound system

#### **CM18X38 Folder**

You can use the software from the following sub-folders:

- AUDIO:** Drivers and software for the built-in audio system
- MODEM:** Drivers and software for the built-in fax/modem

### ***Peripheral Folder***

You can use the software in the following sub-folders:

- KEYBOARD, CD-ROM, MOUSE:** These three folders have drivers for accessories manufactured by BTC. Some system assemblers ship these accessories with complete systems based on this mainboard.

### ***VIA Folder***

The setup program supports to register VIA chipset's function in Windows 95/98.

- IDE :** IDE Bus master drivers for WIN95/98/NT
- IRQ:** This driver is for Windows 95/98. This driver solves some issues regarding the IRQ assignment of PCI Devices.
- Registry:** This driver can register VIA chipset's function.
- USB\_UPDATE:** This driver updates Windows 95 to support USB.
- VxD:** The VxD driver provides support for an AGP graphics adapter.

### ***P6BAP-A+ Folder***

You can use the software in the following sub-folders:

- AUDIO, MODEM:** These folders are empty. A readme file directs you to alternate location with the required software.
- MONITOR :** Hardware monitoring software for Windows 95/98, and Windows NT4.0/5.0

**Note:** *Some folders are subdivided into different operating systems such as DOS, Windows 95, Windows NT, and so on. Always make sure that you are installing the correct software for the operating system on your computer. Some folders are also subdivided into different language versions, such as English, French, German and so on.*

**Note:** *Before installing any software, always inspect the folder for files named README.TXT, INSTALL.TXT, or something similar. These files may contain important information that is not included in this manual.*

---

## Running the Support CD-ROM

---

1. Place the disk in your CD-ROM drive. If you are running Windows with Autoplay enabled, the opening screen of the CD appears automatically. Click on READ ME to read the latest instructions.
2. Click on the item BROWSE THE CD TITLE. This uses Windows Explorer to show the contents of the support CD.
3. Double click on a folder to display the sub-folders.
4. Before installing the software, look for a file named README.TXT, or something similar. This file may contain important information to help you install the software correctly.
5. Some software is installed in separate folders for different operating systems, such as DOS, WIN NT, WIN95/98, and so on. Always log on to the correct folder for the kind of OS you are using.
6. To install the software, you usually execute a file named SETUP.EXE or INSTALL.EXE by double clicking on the filename.

---

## Utility Folder Installation Notes

---

### *Award Flash Memory Utility*

This utility lets you erase the system BIOS stored on a Flash Memory chip on the mainboard, and lets you copy an updated BIOS to the chip. Take care how you use this program. If you erase the current BIOS and fail to write a new BIOS, or write a new BIOS that is incorrect, your system will malfunction.

There are two flash memory utilities called **AWD66.EXE** and **AWD712.EXE**. For this mainboard you must use the **AWD66.EXE** utility. To use the utility, you must be in real-mode DOS (not the DOS box that is available in Windows 95/98/NT). If you are using WINDOWS 95/98, shut down your computer and select the option Restart in DOS in the shut-down dialog box. If you are running Windows NT, shut down your computer and boot from a DOS diskette temporarily in order to run the flash memory utility.

### *DirectX5 Drivers*

The DirectX drivers are for installation only in Windows 95/98. The directX drivers need to be installed before you install an AGP driver. You may be able to get more up-to-date directX drivers from the Microsoft web site. Start the installation by clicking on the file DX5CORE.EXE.

### ***PC-Cillin Anti-Virus Utility***

Anti-virus software is provided for DOS, for WIN95, and WIN 98. Log on to the appropriate directory for your operating system. For DOS, copy all the files in the DOS folder to your hard disk drive. For Windows 95, log on to the Disk 1 folder and run SETUP. For Windows 98, run SETUP.

## **CMI8X38 Folder Installation Notes**

---

### ***Audio Software***

This folder has software and drivers for the sound system that is integrated on this mainboard. Drivers are provided for Windows 95/98, Windows NT, and DOS. An MS-WORD format manual is stored in the MANUAL folder.

#### ***DOS Installation***

Log on to the DOSDRV folder and run the program INSTALL.EXE

#### ***Windows 95/98 Installation***

Please specify the path to the CD-ROM\CMI8X38\AUDIO\W95-98\DRV when your system detects the installed audio system. To install the audio applications, log on to the W95-98 folder, and then log on to the APPS folder. Run the SETUP program.

#### ***Windows NT 4.0 Installation***

1. Press the "Start" button.
2. Move the highlight to "Settings" and select "Control Panel".
3. Double click on the "Multimedia" icon.
4. Select the "Devices" tab.
5. Press the "Add..." button.
6. Select item "Unlisted or Updated Driver" in the "List of Drivers" list box.
7. Specify the path to the PCI audio NT drivers.
8. Select "C-Media CM8738 PCI Device" and press the "OK" button.
9. Choose proper I/O or the "OK" button for the default setting.
10. Restart the Windows NT system.

To install the audio applications, log on to the NT4 folder, and then log on to the APPS folder. Run the SETUP program.

## ***Modem Driver and Software***

Install the Modem driver from the sub-folders for Windows 95/98 or Windows NT4.0.

### ***Windows 95/98***

The modem is a plug and play device so Windows 95/98 will automatically detect the presence of your modem. When the Plug and Play wizard begins to look for modem drivers, click on the button that says ***Have Disk*** and then browse or type in the pathname to the CMI8x58\modem\win9x folder.

### ***Windows NT 4.0***

Follow the instructions in the README file in the WINNT4 sub-folder.

## **VIA Folder Installation Notes**

---

The setup program supports to register VIA chipset's function in Windows 95 and Windows 98.

Installation procedure:

1. Run setup and select "install VIA Chipset Functions 'Registry'", then it will automatically install this program.
2. You can see that it displays "VIA Power Management Controller" and "VIA PCI to USB Universal Host Controller"

Note: If user want to upgrade Windows 95 to Windows 95 OSR 2.1(4.00.950 B), it's necessary to remove USB from other device.

## ***IDE Bus Master Driver***

The IDE Bus Master Drivers are stored in a folder named IDE.

### ***Windows 95/98 Installation***

1. Click the Windows Start button, and then click on Run.
2. Browse to the folder IDE and select the program called SETUP.EXE.
3. Click on the Install button on the setup screen.
4. Follow the instructions on the screen to complete the installation of the Bus Mastering IDE drivers.

### ***Windows NT Installation***

1. Carry out the installation instructions for Windows 95/98 steps 1 to 4.



2. In the Control Panel, select the icon SCSI adapters.
3. Select the Add button on the drivers sheet.
4. Select the item "VIA Bus Master PCI IDE Driver" and click OK.
5. Reboot the system.

### ***Installing the IRQ Routing Driver***

This driver is for Windows 95/98. This driver solves some issues regarding the IRQ assignment of PCI devices.

#### ***Windows 95 Installation***

1. Click the Windows Start button, and then click on Run.
2. Browse to the correct folder and select the program called SETUP.EXE.
3. Follow the instructions on the screen to complete the installation.

#### ***Windows 98 Installation***

1. In the Integrated Peripherals page of the system setup utility, enable the item OnChip USB.
2. In the PNP/PCI Configuration page of the system setup utility, enable the item Assign IRQ for USB.
3. Restart the system and continue with steps 1, 2, and 3 of the Windows 95 installation instructions.

### ***VxD Drivers***

The VxD driver provides support for an AGP graphics adapter. You only need to install this driver if you are running Windows 95, and you have installed the mainboard with an AGP graphics adapter. The VIA VxD driver is for use in Windows 95 version OSR 2.1 (4.00.950 B) or later.

#### ***Windows 95 Installation***

You need the following files installed on your system before beginning the installation:

1. Get the file "USBSUPP.EXE" from Microsoft, which includes the USB supplement and a new memory manager (VMM32.VxD) needed for the AGP DIME (Direct Memory Execute) feature.
2. Get DirectX 5.0 from Microsoft. DirectX 5.0 is the first DirectX version that supports AGP's DIME.
3. Get AGP Master (i.e., AGP VGA) Driver from the vendor of your AGP graphics adapter.

4. Get "VIAGART.VXD", a virtual device manager which usually will be installed in the following installation procedure of the Windows 95 card driver.

#### ***Installation Instructions***

1. Click the Windows Start button, and then click on Run.
2. Browse to the correct folder and select the program called SETUP.EXE.

Follow the instructions on the screen to complete the installation.

## **Mainboard (P6BAP-A+) Installation Notes**

Most of the sub-folders in this folder are empty, with a short README file giving directions to alternate folders for the appropriate software. Two folders contain software that you can install.

#### ***Monitor Sub-folder***

The software in this folder provides a graphical interface to the hardware monitoring feature of this mainboard. The software will run under Windows 95/98 or Windows NT4.0. Follow the installation instructions contained in the file INSTALL.TXT.

## Appendix 1: Quick Jumper Setting Reference

### **JP1: Clear CMOS Memory Jumper**

This jumper lets you erase the system setup settings that are stored in CMOS memory. You might need to erase this data if incorrect settings are preventing your system from operating. To clear the CMOS memory, turn off the system, disconnect the power cable from the mainboard, and short the appropriate pins for a few seconds.

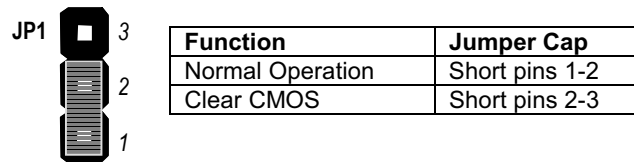

### **JP2: Keyboard Power On Jumper**

This jumper lets you use a typed-in password as a power switch to turn your system on. If you enable this property, you need to define the password or the hot keys using the setup utility. See Chapter 3 for more information.

Function	Jumper Cap
Disable keyboard power on	Short pins 1-2
Enable keyboard power on	Short pins 2-3

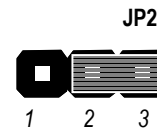

### **JP4: 100MHz System Bus Frequency Select Jumper**

Use this 3-pin jumper to set the system bus frequency. In the normal setting, the system automatically selects the correct frequency according to the kind of processor installed. In the Force 100 MHz setting, the system uses a 100 MHz system bus even if the processor is designed to operate with a 66 MHz bus.

Function	Jumper Cap
Normal	Short pins 1-2
Force 100 MHz	Short pins 2-3



### **JP7: Flash BIOS Enable/Disable Jumper**

The mainboard BIOS is stored on an Erasable Programmable Read Only Memory (EPROM) chip. This means that you can erase the current BIOS and install an updated BIOS whenever new upgrades are released. See Chapter 4 for information on using the Flash BIOS utility. Before erasing the old BIOS and flashing a new BIOS, you must set JP7 to Enable. After the new BIOS is installed, set JP7 to Disable so that the BIOS cannot be erased by accident.

Function	Jumper Cap
Enable flash BIOS	Short pins 1-2
Disable flash BIOS	Open pins 2-3

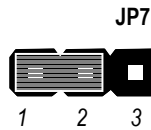

### **JP9: 133MHz System Bus Frequency Select Jumper**

Use this 3-pin jumper to set the system bus frequency. In the normal setting, the system automatically selects the correct frequency according to the kind of processor installed. In the Force 133 MHz setting, the system uses a 133 MHz system bus even if the processor is designed to operate with a 100 MHz bus.

Function	Jumper Cap
66/100MHz	Short pins 1-2
133MHz	Short pins 2-3

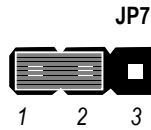

**Note:** When both JP4 and JP9 have the 2-3 pins shorted, the board is set to force a 66 MHz FSB processor to run on a 133 MHz system bus.

**PANEL: Case Switches and Indicators**

Use the Panel connector to implement the switches and indicators on the system case.

Function	Pins
Power Indicator	1+, 2+, 3
Sleep Switch	4, 5
Green Indicator	7+, 8+, 9
Keylock	10, 11
Reset Switch	12, 13
Speaker	15+, 16, 17, 18
Hard Disk Indicator	20+, 21
Power Switch	22+, 23

