P5SJ-A Mainboard

User's Manual





Version 3.0a

Copyright © August 1997 All rights reserved

This publication may not be copied, reproduced, translated, transmitted or reduced to any printed or electronic medium or to any machine readable form, or stored in a retrieval system, either in whole or in part without the written consent of the copyright holders.

The contents of this publication are subject to change. The manufacturer reserves the right to alter the contents of this publication at any time and without notice. The contents of this publication may contain inaccuracies or typographical errors and is supplied for informational use only.

Products are noted in this publication for identification purposes only. Microsoft is a registered trademark and Windows is a trademark of Microsoft Corporation. Pentium is a trademark of Intel Corporation. All other product names or brands may be trademarks or registered trademarks of their respective holders.

Section 1: P5SJ-A Package & Product Information	1.1
About This Manual	1.1
Acrobat Document Features	1.1
Manual Features	1.2
Package Contents	1.3
Component Information	1.5
Expansion Cards & Slots	1.5
Memory Sockets & Modules	1.6
CPU Socket & CPU	1.6
Port & Controller Connections	1.6
Section 2: Using Your Mainboard	2.1
System Controls	2.1
Hardware Controls & Indicators	2.1
CMOS Setup Utility Controls	2.3
Hardware Features	2.6
Onboard Ports	2.6
Connectors	2.6
Optional Hardware	2.8
Firmware & Software	2.9
How To Use The CMOS Setup Utility	2.9
Clearing CMOS	2.9
Flashing The BIOS	2.11
Bus Master Drivers	2.11
Video Drivers	2.11
Disabling Onboard Video Display Card	2.11
Section 3: Reconfiguring Your Mainboard	3.1
Installing Expansion Cards	3.1
ISA Cards & Slots	3.1
Configuring Expansion Card Resources In CMOS Setup	3.2
Adding System Memory	3.6
Memory Configurations	3.6

Installing A CPU Upgrade	3.9
The Basic Procedure	3.9
Configuring External Clock Speed & Factor	3.10
Configuring CPU Voltage	3.10
CPU Jumper Tables & Illustrations	3.12
Adding An IDE Peripheral	3.16
IDE Transfer Modes	3.16
Installing IDE Devices	3.18
Adjusting Display Memory	3.19
Section 4: P5SJ–A Reference Information	4.1
Using This Section	4.1
Jumper Configuration Summary	4.3
Supported CPUs	4.8
Interpreting CPU Markings	4.9
System Memory Specifications	4.11
Memory Configurations	4.11
CMOS Setup Utility Summary	4.12
Using the CMOS Setup Utility	4.12
Accessing The CMOS Setup Utility	4.12
Standard CMOS Setup	4.16
BIOS Features Setup	4.20
Chipset Features Setup	4.25
Power Management Setup	4.27
PNP/PCI Configuration	4.32

In This Section:

About This Manual

Package Contents

Component Information

P5SJ-A Package & Product Information

This manual contains all the information you'll need to use the P5SJ-A mainboard. Please take a moment to familiarize yourself with the design and organization of the manual.

About This Manual

This manual is divided into four sections:

- **Section 1: Package & Product Information**
A brief overview of what comes in the mainboard package, its basic features, layout and component information.
- **Section 2: Using Your Mainboard**
Information on mainboard features that you may make use of in operating your computer.
- **Section 3: Reconfiguring Your Mainboard**
How to change or upgrade the mainboard configuration.
- **Section 4: Reference Information**
A summary of the mainboard's settings and specifications.



The manual uses some icons to call your attention to important information. The icons appear in the sidebar and represent the following:

- Important information
- A recommendation or good idea
- A warning or bad idea
- Danger warning

Online Manual Format

If the support disk for your mainboard is a CD-ROM disc, a copy of the printed manual may be stored on the disc in Adobe Acrobat format. If so, it requires Adobe Acrobat Reader version 3.0 or later to view it. Acrobat Reader for Microsoft Windows95 may also be supplied on the Support Disk. If not, you can obtain a free copy of the Reader software from the Adobe web site which is currently at www.adobe.com as well as other locations.

If you have the online manual, you may want to install Acrobat Reader on your system hard disk. You can copy the manual over as well so that the manual is readily available without having to hunt up the Support Disk when you want to view it.

If you are unfamiliar with Acrobat Reader, please take a moment to view the Reader Online Guide which is available under the Help menu when you run Reader.



P5SJ-A Models

There are two models of the P5SJ-A mainboard. One has a video display feature on board – SIS5598, the other – SIS5582– does not. If you have the model with the onboard display feature, it comes with an external VGA port bracket with an attached cable that connects to the mainboard. Other than this feature, the two models are functionally identical.

You can tell which model you have by looking at the big green heat sink in the middle of the board.

Package Contents

The P5SJ-A mainboard package contains the following items, as noted in the Quick Installation Guide. We've listed them here again for your convenience. Please inspect the package contents and confirm that everything is there. If anything is missing or damaged, call your vendor for instructions before proceeding. The package includes:

- P5SJ-A Mainboard
- Cable Pack:
 - 1 Floppy Controller Cable
 - 1 IDE Controller Cable
 - 1 VGA Port Bracket with attached cable (SIS 5598 model)
- Optional Hardware:
 - External USB dual-port bracket
- Support CD:
 - IDE Bus Master Drivers
 - Display Drivers

The SIS VGA display comes with drivers for a wide range of Operating Systems. These are organized in individual folders. In each folder there is a “readme” file that explains how to install the driver. Please locate the folder for the driver you need and check this file.

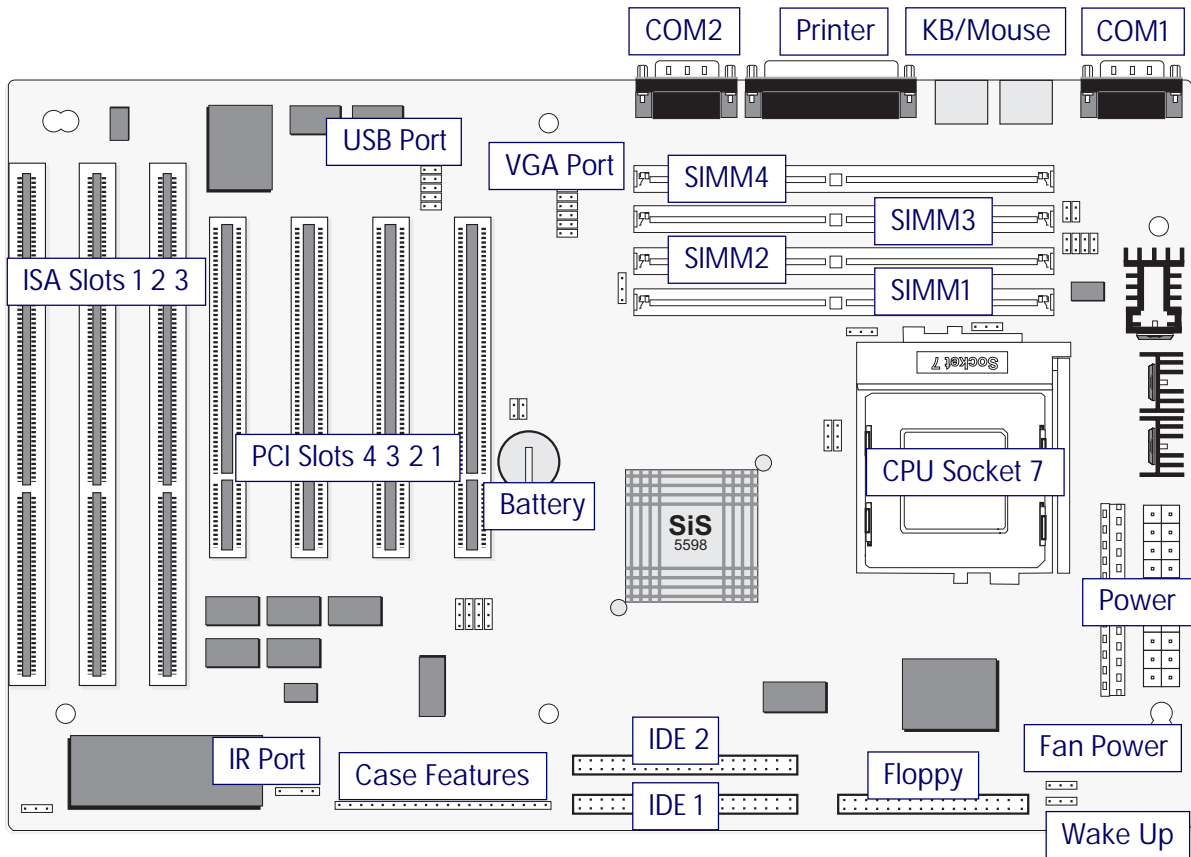

P5SJ-A Layout

The illustration above shows the connectors, sockets and ports and the mainboard. This illustration is referred to later in the manual and there are links back to this page for your reference.

The VGA Port is a connector for the external VGA port bracket. If you have the version of this mainboard with no VGA, this connector is not installed on the board. The USB Port is a connector for the optional external dual USB port bracket.

The IR Port is a connector for an optional IrDA-compatible infrared port module.

Component Information

This section is a brief description of the components on the mainboard that you might need to know about if you want to upgrade or change your system configuration. If your mainboard is already installed in a system, it isn't necessary for you to review this section.

This mainboard uses the ATX 'form factor', a design that integrates many features onto the board including some number of external ports.

Expansion Cards & Slots

The mainboard has seven expansion slots for system expansion or 'add-on' cards. Three of them are ISA slots, the other four are PCI slots. When you get an expansion card, it must use one of these to connect to the computer.

The ISA expansion slots are a legacy of the original IBM PC/AT design. They are 16-bit slots that run at a moderate bus speed. There are many kinds of expansion cards that use this slot design to connect to the computer, some of the most common being sound and modem cards.

PCI slots are the current high-speed 32-bit standard for system expansion cards. They operate at a faster speed and have a greater data throughput than ISA cards.

Expansion cards often make use of system resources, which requires managing the system resource configuration. Most newer expansion cards support the 'Plug and Play' standard that allows an Operating System like Windows95 to automatically detect them and configure system resources as needed. Some older ISA designs may not support this standard and may therefore require manual configuration. You should consult the specifications or documentation for a card to determine if this is the case and what needs do be done to properly configure the card.

Memory Sockets & Modules

There are four memory module sockets on the mainboard. They use 72-pin SIMM memory modules. The sockets are paired into two 'banks.' This means you must install two modules at a time. This mainboard has a very flexible memory design that allows the use of a variety of memory options up to a total of 256MB. There is more information about this in 'Adding System Memory' section of Section 3: Reconfiguring Your Mainboard.

CPU Socket & CPU

The Socket 7 CPU socket supports the full range of Pentium®-class CPUs including MMX Pentiums®. Installing a CPU in the socket is easy. The lever at the side of the socket latches the CPU in place when it is down and releases it when raised.

If you want to install a CPU upgrade or are installing a CPU on the board for the first time, please refer to 'Installing a CPU' in Section 3: Reconfiguring Your Mainboard.

Port & Controller Connections

This mainboard has two external Serial ports, one Parallel port and a PS/2-type keyboard and mouse port built onto the board. There are also several connectors built onto the board. There are connectors for four IDE devices in two 'channels' and for two floppy disk drives. There are also some connectors on the board for some system case features and a CPU cooling fan.

In addition, there is a connector for an optional external double USB (Universal Serial Bus) port bracket that is an option for this mainboard. If you have the version of this mainboard that has the onboard video display card, there is also a connector for an external VGA port bracket.

Details about these connectors are in Section 4: Reference Information.

In This Section:

System Controls

Hardware Features

Firmware & Software

Using Your Mainboard

This section covers the following topics:

- System Controls & Indicators
- Hardware Features
- Firmware & Software

They go over the system control features and status indicators that derive from the mainboard and explain the software that comes with or is built-into the mainboard

System Controls

There are two topics in this section, a explanation of the hardware controls and status indicators that connect from the mainboard to your system case and some information about the parts of the CMOS Setup Utility that allow you customize some system features.

Hardware Controls & Indicators

There are some control features and status indicators that connect from the mainboard to your system case, which is sometimes called the ‘Enclosure’ or ‘Chassis.’ These are:

- Power Switch
- Power Status Indicator
- Suspend Switch
- Suspend Status Indicator
- Reset Switch
- Hard Disk Drive Activity Indicator
- Keyboard Lock

All of these case features connect to the mainboard via connector strip J7. Not all system cases have all of these features, so your system may not have all of them. The functions and options for these are shown in the table on the next page.

Hardware Controls & Indicators

Feature	J7 Pins	Function
Power Switch	19-20	Turns the system power on and off. In some systems, push once for Suspend, push for >4 seconds for Off.
Power Status LED	1-3	When lighted indicates that system is turned on
Suspend Switch	4-5	Puts the system into Suspend state under Operating Systems that support this power management feature
Suspend LED	6-8	When lighted indicates that system is suspended
Reset Switch	9-10	Pressing the Reset switch restarts the system
HDD Activity	17-18	Flashes when hard disk drive is active
Keyboard Lock	11-12	Disables keyboard via a lock mounted on front panel of the case

CMOS Setup Utility Controls

Two sections of the CMOS Setup Utility allow you to configure how some of your system’s features work. These are:

- BIOS Features Setup
- Power Management Setup

The CMOS Setup Utility is a program that is permanently stored in the BIOS chip on the mainboard. The utility creates a system hardware configuration record that it stores in a small amount of battery-supported memory on the board. The BIOS uses this record to function as an interface between the system hardware and the operating system. Most of the settings in the CMOS Setup Utility are made automatically, so you won’t normally need to use this program. You can, however, customize some of the operational features to suit how you prefer to use the program.

The screen illustrations on the next two pages show the Setup Default settings for these two sections of the utility.

The CMOS Setup Utility Summary in Section 4: Reference Information, lists the setting options for each section of the utility including the two noted above.

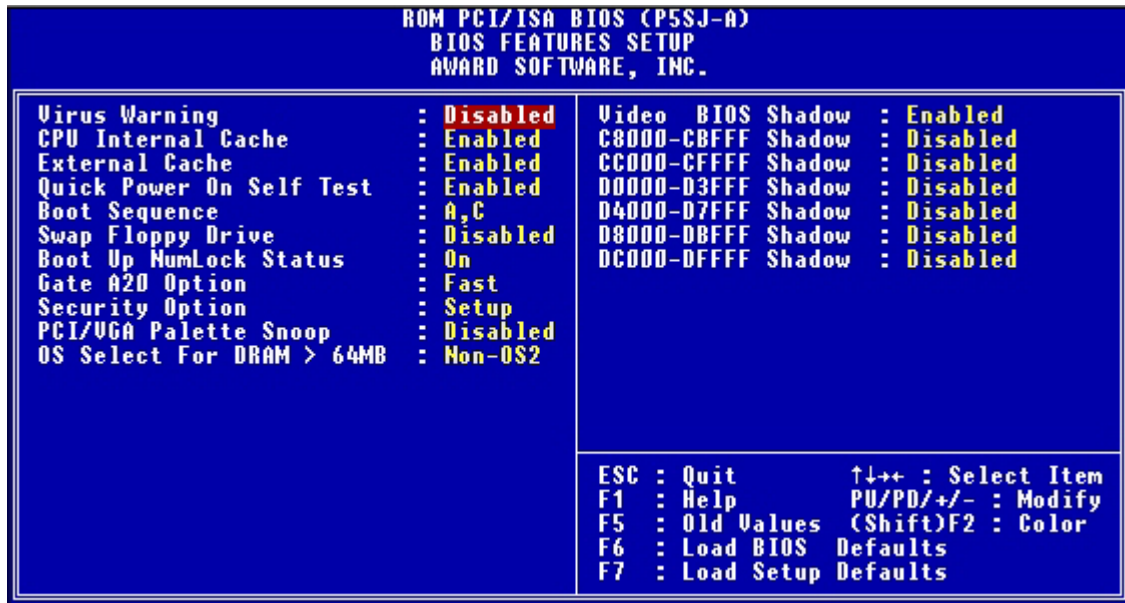

CMOS Setup Utility – BIOS Features Setup
 This section of the setup utility allows you to configure some system features including Virus Warning, Boot Sequence and Security Option.

Virus Warning –
 When enabled, monitors the primary hard disk boot sector and warns of any attempt to write to it.

Boot Sequence –
 Controls the order in which the system checks disk drives for a boot disk.

Security Option –
 Sets the level of password protection for the system.

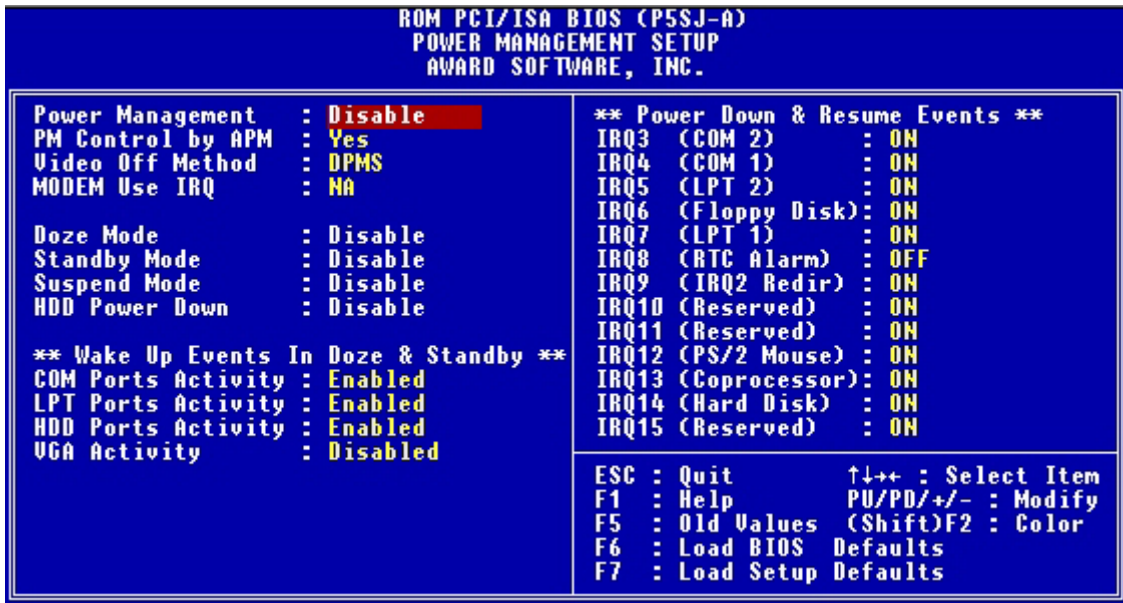

CMOS Setup Utility –
Power Management Setup
This section of the setup utility allows you to configure the power management features supported by the BIOS. These can also operate in tandem with Operating System power management features.

You can use the Min Saving or Max Saving default modes or you can configure the power management features individually in the User Define mode.

Hardware Features

This section is a brief overview of information about the mainboard’s hardware features that connect to external devices.

Onboard Ports

There are five external ports on the mainboard. These are ports standard to most personal computers:

- COM1 Serial Port
A high-speed serial port which can also be configured as the COM3 port in the CMOS Setup Utility.
- COM2 Serial Port
A high-speed serial port which can also be configured as the COM4 port in the CMOS Setup Utility.
- Parallel Port
The parallel port can be configured as a Standard, ECP or EPP parallel port in the CMOS Setup Utility
- PS/2 Keyboard Port
- PS/2 Mouse Port

Connectors

There are several connectors on the mainboard for connecting additional ports and internal peripheral devices

- IDE 1 – Primary IDE Channel
A high-speed serial port which can also be configured as the COM3 port in the CMOS Setup Utility.
- IDE 2 – Secondary IDE Channel
A high-speed serial port which can also be configured as the COM4 port in the CMOS Setup Utility.
- Floppy Connector
The parallel port can be configured as a Standard, ECP or EPP parallel port in the CMOS Setup Utility

```

ROM PCI/ISA BIOS (P5SJ-A)
INTEGRATED PERIPHERALS
AWARD SOFTWARE, INC.

IDE HDD Block Mode      : Enabled
OnChip Primary PCI IDE : Enabled
OnChip Secondary PCI IDE : Enabled
IDE Primary Master PIO  : Auto
IDE Primary Slave PIO   : Auto
IDE Secondary Master PIO : Auto
IDE Secondary Slave PIO : Auto
Primary Master UltraDMA : Auto
Primary Slave UltraDMA  : Auto
Secondary Master UltraDMA : Auto
Secondary Slave UltraDMA : Auto

Onboard FDD Controller  : Enabled
Onboard Serial Port 1   : 3F8/IRQ4
Onboard Serial Port 2   : 2F8/IRQ3
UART 2 Mode             : Standard
Onboard Parallel Port   : 378/IRQ7
Onboard Parallel Mode   : SPP

USB Controller          : Disabled

ESC : Quit           ↑↓+ : Select Item
F1  : Help          PU/PD/+/- : Modify
F5  : Old Values    (Shift)F2 : Color
F6  : Load BIOS Defaults
F7  : Load Setup Defaults

```

CMOS Setup Utility –

Integrated Peripherals

This section of the setup utility configures the IDE and Floppy controllers and the settings for the external ports

This section enables and configures the optional USB and Infrared features.

The screen illustration shows the settings when Setup Defaults are loaded.

Optional Hardware

There two feature connectors on the mainboard for optional ports. These require optional external port hardware.

USB Ports

The USB1 connector on the mainboard supports two Universal Serial Bus ports. An optional external port bracket attaches to the onboard connector via an attached cable.

With the optional port bracket installed you can attach USB devices to the external ports. If the USB ports are installed, the USB Controller line in the Integrated Peripherals section of the CMOS Setup utility must be set to 'Enabled'. USB ports may also require Operating System support for USB devices.

IR Port

The onboard IR connector supports an Infra-Red port module that enables wireless communication between the computer and other computers and devices with infrared capability.

The port module is an optional component. If it is installed, you must set the UART 2 line in the Integrated Peripherals section of the CMOS Setup utility to the appropriate IR mode used by the module.

Firmware & Software

The mainboard hardware is supported by both firmware and software components. Firmware is software that is stored on a chip on the board rather than on disk media.

The firmware component you interface with on this mainboard is the CMOS Setup Utility. This utility establishes various settings used by the BIOS, the basic software that is an interface between the system hardware and software.

The software component is comprised of software drivers that support the PCI IDE controller and the 5598 model onboard VGA video display card.

How To Use The CMOS Setup Utility

The CMOS Setup Utility options are listed in detail in Section 4: Reference Information. This section is just a brief explanation of how to run the program to adjust settings as noted in this and the next section.

To run the CMOS Setup Utility, press the Del or Delete key while the computer is starting up, before the operating starts to load. The utility’s main screen will appear as shown on the next page. To navigate the program, use the controls shown on the screen. The utility has several sections. Many of the features configured by the utility are set to operate automatically when the ‘Setup Defaults’, the recommended mode, are used. With Setup Defaults loaded you can still customize various settings.

Clearing CMOS

Under some unusual circumstances the configuration record created by the CMOS Setup utility and stored on the mainboard can become corrupted and unusable, possibly leading to the board being unable to operate properly. If this happens, the CMOS record can be cleared by setting jumper JP16 to the clear setting for a moment and then setting it back to the Normal setting. Refer to Section 4 for more information.

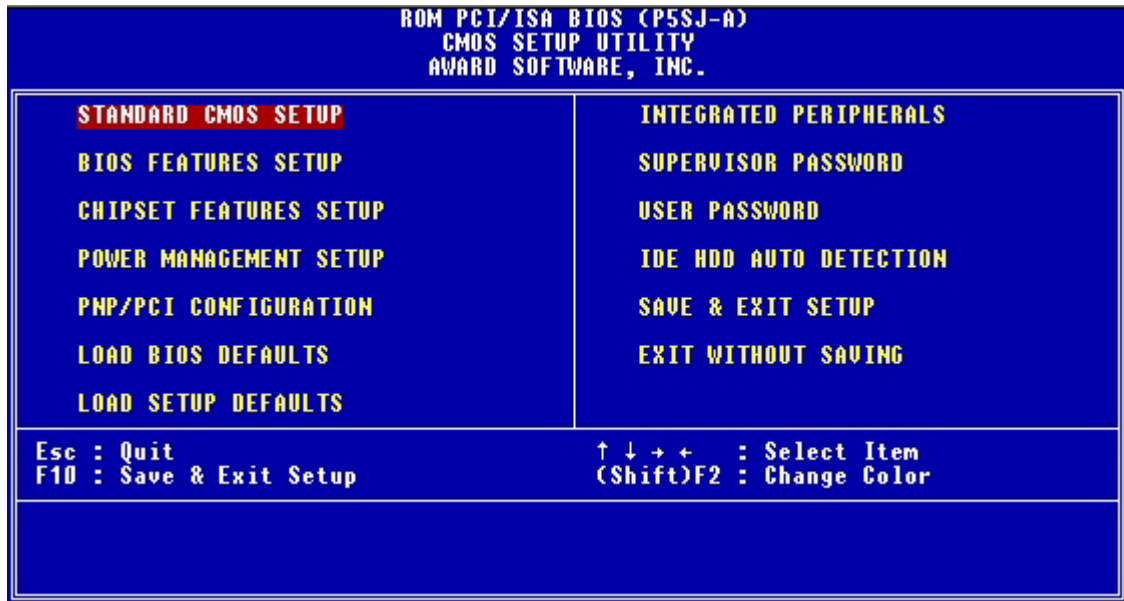

CMOS Setup Utility –

This is the main screen for the setup utility from which you access its various sections. The function and use of each section is covered in Section 4: Reference Information.

Flashing The BIOS

This mainboard uses the Award BIOS. The BIOS is stored on a programmable flash memory chip on the mainboard. Updates to the BIOS can be installed by installing a new BIOS file on the flash chip, which replaces the existing one. You do this using software that comes on the Support Disk. There is an explanation of how to install a BIOS update in a ‘readme’ text file included with the program.

To install a BIOS update, you must set the JP20 ‘Flash Boot Block’ jumper to ‘Enabled’ while installing the BIOS and then set it back to the ‘Disable’ setting for normal operation.

Bus Master Drivers

This mainboard comes with software drivers, for various Operating Systems, that enable the PCI controller to operate in ‘Bus Master’ mode. The drivers are on the Support Disk. The included ‘readme’ file has information on the drivers and installation information.

Video Drivers

The 5598 model of this mainboard has an onboard SIS VGA video display card. A wide variety of display drivers are provided with the board to support various Operating Systems. When you run the installation program you can view information about the drivers and make selections on which to install.

A text file is included that describes the drivers provided.

Disabling Onboard Video Display Card

If you have the 5598 model of this mainboard and want to use a different video display card you can disable the onboard SIS VGA video display. To do this you must set jumpers JP23, 24 and 25 to their ‘Disable’ settings. See Section 4 : Reference Information for more information.

Jumper Settings Mentioned In This Chapter

Function	Jumper	Settings		
CMOS Setup Record	JP16	Normal Clear	1-2 2-3	Default
Flash BootBlock	JP20	Disable Enable	2-3 1-2	Default
Onboard VGA	JP23,24,25	Enable Disable	23:1-2, 24:2-3, 25:1-2 23:2-3, 24:1-2, 25:2-3	Default

In This Section:

Installing Expansion Cards
Adding System Memory
Installing A CPU Upgrade
Adding An IDE Peripheral
Adjusting Display Memory

Reconfiguring Your Mainboard

This section explains how to install new hardware on your mainboard. It covers installing expansion cards, adding system memory, changing the CPU and installing additional IDE peripheral devices such as a hard disk or a CD-ROM drive.

Installing Expansion Cards

There are seven expansion card slots on the mainboard, three ISA slots and four PCI slots. When you get an expansion card, it will come with instructions on how to install it, so this section covers relevant information from the mainboard side only.

ISA Cards & Slots

ISA expansion cards often use system resources in the form of IRQs and DMA channels. Newer cards that comply with the Plug and Play (PnP) standard are designed to allow the Operating System to automatically configure system resources. Cards that do not support PnP may require manual configuration of both the card hardware and settings in the CMOS Setup Utility.

If you have a PnP-compliant card to install there should be little to do other than follow the installation instructions. If, however, you have a non-PnP card and it requires configuring system resources, you may need to review the third part of this section, Configuring Expansion Card Resources In CMOS Setup.

Running CMOS Setup

To run the CMOS Setup utility, press the Delete or the Del key while your computer is first starting up. Select the ‘PNP/PCI CONFIGURATION’ item on the main screen and press the Enter key to open it. When you are finished, press the Esc key once to return to the main screen and then select ‘SAVE & EXIT SETUP’ and press the Enter key to save the new configuration. For more information on this see Section 4: Reference Information.

PCI Cards & Slots

With very few exceptions, any PCI expansion card you are likely to get will be Plug and Play compliant. If you are using an Operating System that supports PnP, such as Windows 95, you should be able to follow the installation instructions that come with the card and have the Operating System automatically recognize and configure the card.

The four PCI slots on the mainboard all have ‘Bus Master’ capability. For installed PCI cards to use this feature an Operating System-specific Bus Master software driver that comes with this mainboard must be installed under your Operating System. These drivers are located on the Support Disk. There is more information about them later in this section.

Configuring Expansion Card Resources In CMOS Setup

The CMOS Setup Utility, which is covered in detail in Section 4: Reference Information, has a section called PNP/PCI Configuration. The default settings in this section allow the Operating System to automatically configure IRQ resources for PnP compliant ISA and PCI Cards.

If you need to install a non-PnP card, you will need to configure any IRQ and DMA settings manually, both on the card and in the CMOS Setup Utility. The following three pages show how to do this.

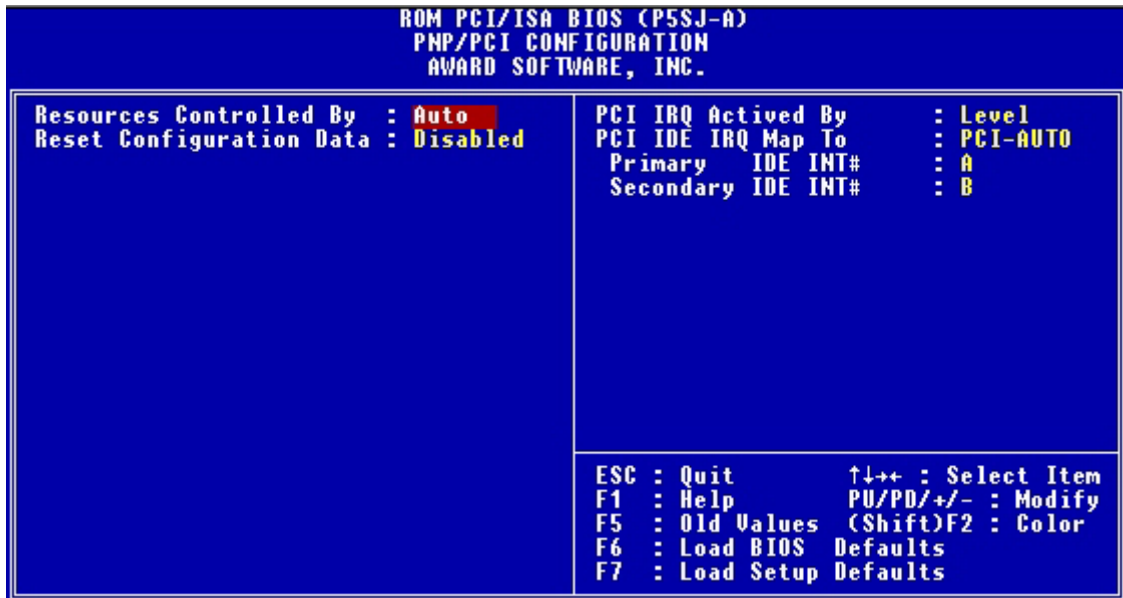

CMOS Setup Utility –

Pnp/PCI Configuration

This is the default screen for this section when Setup Defaults are loaded. If you need to manually configure the IRQ settings, set the first item on the screen to the 'Manual' setting. See the next page.

```

ROM PCI/ISA BIOS (P5SJ-A)
PNP/PCI CONFIGURATION
AWARD SOFTWARE, INC.

Resources Controlled By : Manual
Reset Configuration Data : Disabled

IRQ-3 assigned to : PCI/ISA PnP
IRQ-4 assigned to : PCI/ISA PnP
IRQ-5 assigned to : PCI/ISA PnP
IRQ-7 assigned to : PCI/ISA PnP
IRQ-9 assigned to : PCI/ISA PnP
IRQ-10 assigned to : PCI/ISA PnP
IRQ-11 assigned to : PCI/ISA PnP
IRQ-12 assigned to : PCI/ISA PnP
IRQ-14 assigned to : PCI/ISA PnP
IRQ-15 assigned to : PCI/ISA PnP
DMA-0 assigned to : PCI/ISA PnP
DMA-1 assigned to : PCI/ISA PnP
DMA-3 assigned to : PCI/ISA PnP
DMA-5 assigned to : PCI/ISA PnP
DMA-6 assigned to : PCI/ISA PnP
DMA-7 assigned to : PCI/ISA PnP

PCI IRQ Activated By : Level
PCI IDE IRQ Map To : PCI-AUTO
Primary IDE INT# : A
Secondary IDE INT# : B

ESC : Quit          ↑↓↓+ : Select Item
F1  : Help          PU/PD/+/- : Modify
F5  : Old Values   (Shift)F2 : Color
F6  : Load BIOS Defaults
F7  : Load Setup Defaults

```

CMOS Setup Utility –

Pnp/PCI Configuration

When 'Resources Controlled By' is set to 'Manual' you can individually configure the IRQ & DMA channel settings. The individual defaults are for PnP cards and will still use all the items listed to automatically assign resources as needed.

If you are installing a 'legacy' ISA card that requires manual configuration, you can manually assign the required resources as needed. See the next page for an example.

```

ROM PCI/ISA BIOS (P5SJ-A)
PNP/PCI CONFIGURATION
AWARD SOFTWARE, INC.

Resources Controlled By : Manual
Reset Configuration Data : Disabled

IRQ-3 assigned to : PCI/ISA PnP
IRQ-4 assigned to : PCI/ISA PnP
IRQ-5 assigned to : Legacy ISA
IRQ-7 assigned to : PCI/ISA PnP
IRQ-9 assigned to : PCI/ISA PnP
IRQ-10 assigned to : PCI/ISA PnP
IRQ-11 assigned to : PCI/ISA PnP
IRQ-12 assigned to : PCI/ISA PnP
IRQ-14 assigned to : PCI/ISA PnP
IRQ-15 assigned to : PCI/ISA PnP
DMA-0 assigned to : PCI/ISA PnP
DMA-1 assigned to : PCI/ISA PnP
DMA-3 assigned to : PCI/ISA PnP
DMA-5 assigned to : PCI/ISA PnP
DMA-6 assigned to : PCI/ISA PnP
DMA-7 assigned to : PCI/ISA PnP

PCI IRQ Activated By : Level
PCI IDE IRQ Map To : PCI-AUTO
Primary IDE INT# : A
Secondary IDE INT# : B

ESC : Quit          ↑↓←→ : Select Item
F1  : Help          PU/PD/+/- : Modify
F5  : Old Values   (Shift)F2 : Color
F6  : Load BIOS Defaults
F7  : Load Setup Defaults

```

CMOS Setup Utility – Pnp/PCI Configuration

This screen shows an example of a manually configured IRQ setting for a "Legacy" ISA expansion card. Legacy cards, by definition, are not PnP compliant and must be manually configured if they require an IRQ or DMA channel. See the card manual for specifics.

When an item in the list is configured this way, it is no longer part of the pool of automatically configurable resources. For this reason, don't configure ISA cards this way unless they are Legacy cards.

Adding System Memory

There are some requirements you must follow if you want to install system memory. The memory subsystem has four 72-pin SIMM sockets divided into two banks, SIMM1 & SIMM2 and SIMM3 & SIMM4. You must install SIMM modules in pairs using the same type and speed of module in each bank. This mainboard supports both Fast Page Mode (FPM) and EDO DRAM modules. You can use module sizes from 2MB to 128MB, either single or double-sided. The total supported memory capacity for this mainboard is 256MB.

If your mainboard is already installed in a system, it will have some amount of memory installed on the board. You can tell how much by checking the configuration screen that appears when the computer is starting up. With some memory installed, there will be two sockets available to add additional memory.

Memory Configurations

You can install any system memory combination as long as you follow the basic requirement of installing identical modules in both sockets of a bank, i.e.:

- All modules must be 5 Volt
- Same module memory capacity, e.g. 16MB (MegaBytes)
- Same DRAM memory type, e.g. EDO
- Same operating speed, e.g. 60ns (nanoseconds)

Other than these requirements, there is no limitation on the variety of possible combinations, so they are not listed here.

Note: It is possible to install more memory than the board supports, e.g. four 128MB modules would total 512MB, but the board would ignore 256MB of that. Do not install more than 256MB on this mainboard.



Don't mix DRAM types in the same bank, the system will treat higher performance EDO DRAM as Fast Page and any performance benefit will be lost. It is best to install memory of the same speed in both banks.

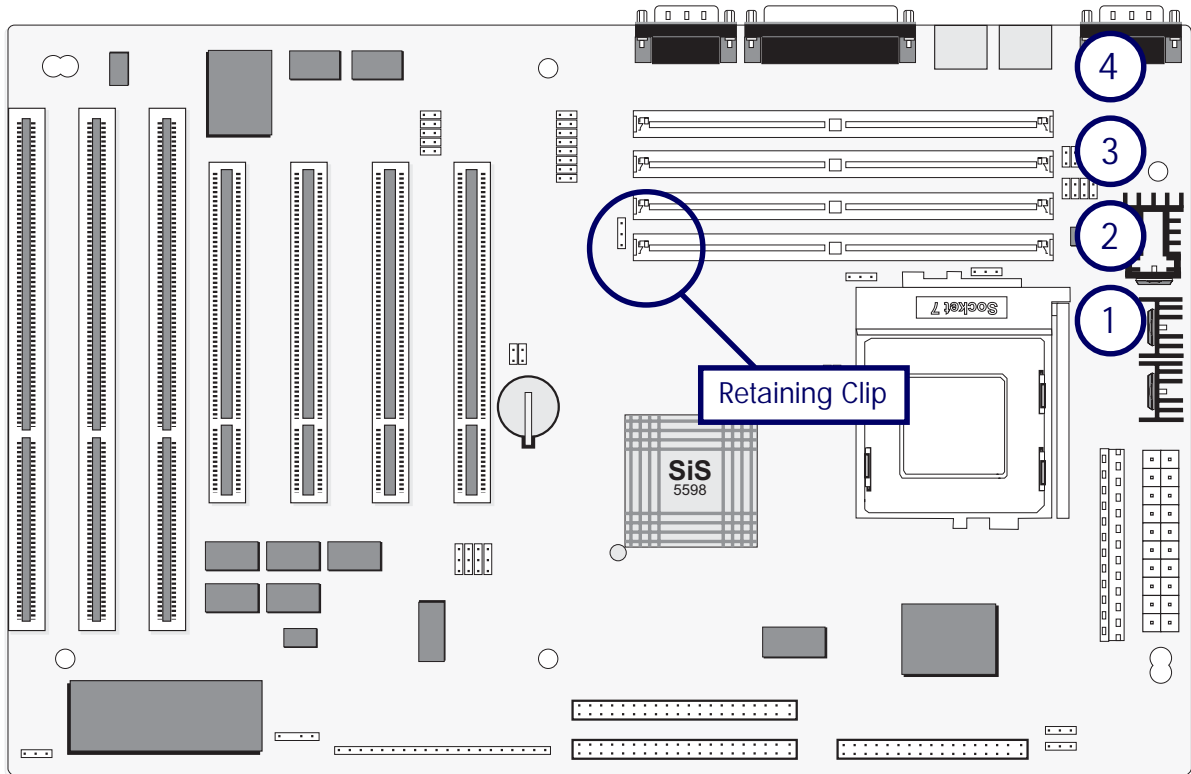

SIMM Sockets

The picture above shows the memory module sockets in detail. The sockets are numbered SIMM1 to SIMM4 starting from the bottom socket in the picture. You must install modules in pairs in either sockets 1 & 2 or 3 & 4.

Modules snap into place and are held in position by a retaining clip at each end of the SIMM socket.

When you want to remove a module, press down on the retaining clips to release the module from the socket.

Installing Memory Modules

To install a module, inset it into the socket at about a 45° angle and then push it up into the retaining clips so that it snaps in place and is at a 90° angle to the board. Modules are designed so that they will only insert in one orientation. If you have trouble inserting the connector edge of the module into the socket, it may be oriented the wrong way. Turn the module around and try again. You shouldn’t need to force it.

If All Sockets Are Occupied

If you want to install more memory and there are no sockets available, you must remove some installed modules and replace them with the upgrade modules.

If you have to do this, make sure to identify what type of memory is already installed. In some cases, there may be a mix of module types. You can tell this by checking the configuration screen that appears while the computer is starting up. Press the Pause key to temporarily interrupt the start-up process while the screen is visible so that you have more time to read it. When you’re done press any key to resume.

Remove the lowest performance and smallest size modules and replace them with the upgrade. For example, if you have the following configuration and you plan to install two 16MB EDO modules:

- SIMM 1 & 2: 8MB Fast Page mode modules
- SIMM 2 & 3: 8MB EDO modules

You should remove the two 8MB FP modules because they are lower performance and replace them with the memory upgrade, resulting in the greatest performance gain.

Installing A CPU Upgrade

If you are installing this mainboard it will not have a CPU installed unless your vendor installed one when you purchased the board. If the mainboard is installed in a system, there will already be a CPU installed. In either case the information and procedure for installing a CPU is the same. Since the more likely scenario is that you are installing an upgrade, this section assumes that is what you are doing.

The Basic Procedure

To install a CPU on this mainboard you need to set up the board for a specific CPU by doing the following:

- Set the External Clock Speed
- Set the Clock Multiplier Factor
- Set the CPU Voltage

You configure the CPU settings by adjusting jumper settings on the board. In order to do this, you will need to know some information about the CPU you plan to install. This should be provided by the CPU vendor or by the vendor you buy the chip from. You’ll need the following information:

- CPU Internal Clock Speed
- CPU Voltage

The internal clock speed is the speed the CPU operates at to process data and is the one used by CPU manufacturers to indicate the speed of the chip, for example, a 133MHz Intel Pentium®. The CPU also has an external clock speed which is the speed at which it interacts with external components.

CPU voltage may either be the same internally and externally or it may be split, depending on the CPU design. Some processors use one voltage for the ‘core’ (Vcore) and another for input/output (Vio).

Configuring External Clock Speed & Factor

To configure the board for a CPU's internal clock speed, you have to set the external clock speed (sometimes referred to as the bus speed) and the clock factor so that the result is the internal clock speed of the CPU you are installing. For example, the default setting for these is:

$66.6\text{MHz} [\text{external clock}] \times 2.0 [\text{clock factor}] = 133.2\text{MHz}$
or, an effective setting of 133MHz.

Since the internal clock speed the CPU is supposed to operate at is fixed, the two factors, external clock and clock factor, are the variables. The CPU manufacturer or vendor's information should tell you what these factors should be.

P Rated CPUs

Cyrix, IBM and AMD all make Pentium®-class CPUs that are performance rated at an Intel Pentium® equivalent speed but actually have a slower internal clock speed. This 'P' rating is used to indicate the CPU's performance rather than its internal clock speed. For example, the Cyrix/IBM P166 has an actual internal clock speed of 133MHz. If you install a CPU of this type, make sure you set the mainboard for the actual internal clock speed of the CPU, not its P rating.

Configuring CPU Voltage

The CPU voltage specification should also be provided in information from the manufacturer or vendor. Standard Pentium® CPUs are single voltage. MMX Pentiums® are dual-voltage. You should set the CPU Voltage jumpers according to the specifications you get with the CPU.

Standard CPU Settings

Intel Pentium CPUs

Internal Clock	External Clock	Clock Factor
75MHz	50MHz	1.5
90MHz	60MHz	1.5
100MHz	66.6MHz	1.5
120MHz	60MHz	2.0
133MHz	66.6MHz	2.0
150MHz	60MHz	2.5
166MHz	66.6MHz	2.5
200MHz	66.6MHz	3.0

Cyrix/IBM 6X86 CPUs

Internal Clock	External Clock	Clock Factor
P120+ (100MHz)	50MHz	2.0
P133+ (110MHz)	55MHz	2.0
P150+ (120MHz)	60MHz	2.0
P166+ (133MHz)	66.6MHz	2.0
P200+ (166MHz)	66.6MHz	3.0

AMD K5 CPUs

Internal Clock	External Clock	Clock Factor
PR75 (75MHz)	50MHz	1.5
PR90 (90MHz)	60MHz	1.5
PR100 (100MHz)	66.6MHz	1.5
PR120 (90MHz)	60MHz	1.5
PR133 (100MHz)	66.6MHz	1.5
PR150 (120MHz)	60MHz	2.0
PR166 (133MHz)	66.6MHz	2.0



In practice, for an Off setting on a two-pin jumper, place the cap over one pin so that it doesn't get lost.

CPU Jumper Tables & Illustrations

The next few pages show the CPU jumper settings. The settings are listed in the tables as follows:

- Where two pins are shorted (connected) by a jumper cap on a three-or-more-pin jumper the shorted pins are listed, e.g. 1-2 or
- For a two-pin jumper, On, if the cap is in place, and Off, if the cap is not in place.

In the jumper illustrations, the Pin 1 position is shaded and the jumpers, shown in a “bird’s eye” view, look like this:



A jumper with a cap in position looks like this:



The default settings are noted in the tables.

CPU Jumper Settings

Function	Jumper	Settings		
External Speed	JP12–JP15	50MHz	12:2-3, 13:2-3, *14:1-2 25MHz, 15:2-3	
		55MHz	12:2-3, 13:2-3, *14:1-2 27.5MHz, 15:1-2	
		60MHz	12:2-3, 13:1-2, *14:1-2 33.3MHz, 15:2-3	
		Default	66.6MHz	12:1-2, 13:2-3, *14:1-2 30MHz, 15:2-3
		75MHz	12:2-3, 13:1-2, *14:1-2 37.5MHz, 15:1-2	

*The 2-3 setting for JP14 sets the PCI bus clock to 32MHz for all speeds.

Internal Clock Factor	JP18	1.5x	BF0:1-2 BF1: 1-2	Default
		2.0x	BF0:2-3BF1: 1-2	
		2.5x	BF0:2-3BF1: 2-3	
		3.0x	BF0:1-2 BF1: 2-3	

I/O Voltage	JP6	STD 3.3V	1-2	Default
		VRE 3.52V	3-4	

Core Voltage	JP22		1-2	3-4	5-6	7-8	Default
On= Cap On		Single*	On	On	On	On	
Off= Cap Off		2.54V	Off	On	Off	On	
		2.84V	On	Off	Off	Off	
		2.94V	On	Off	Off	On	
		3.24V	On	On	Off	Off	
		3.34V	Off	On	On	Off	

* Single means the core voltage is the same as the I/O voltage

External Clock Speed

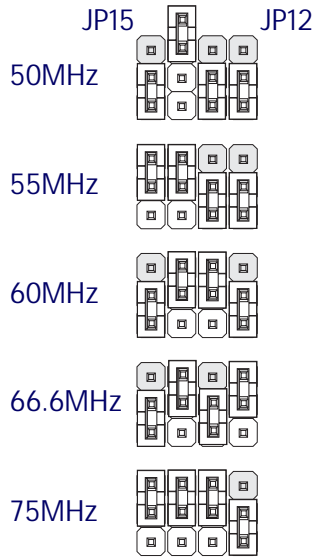

Clock Factor

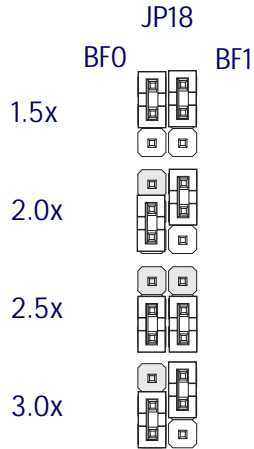

CPU I/O Voltage (Vio)

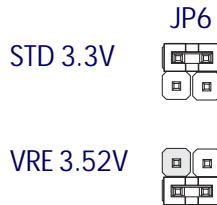

CPU Core Voltage (Vcore)

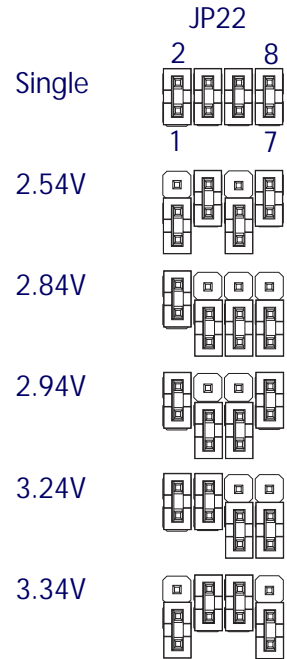

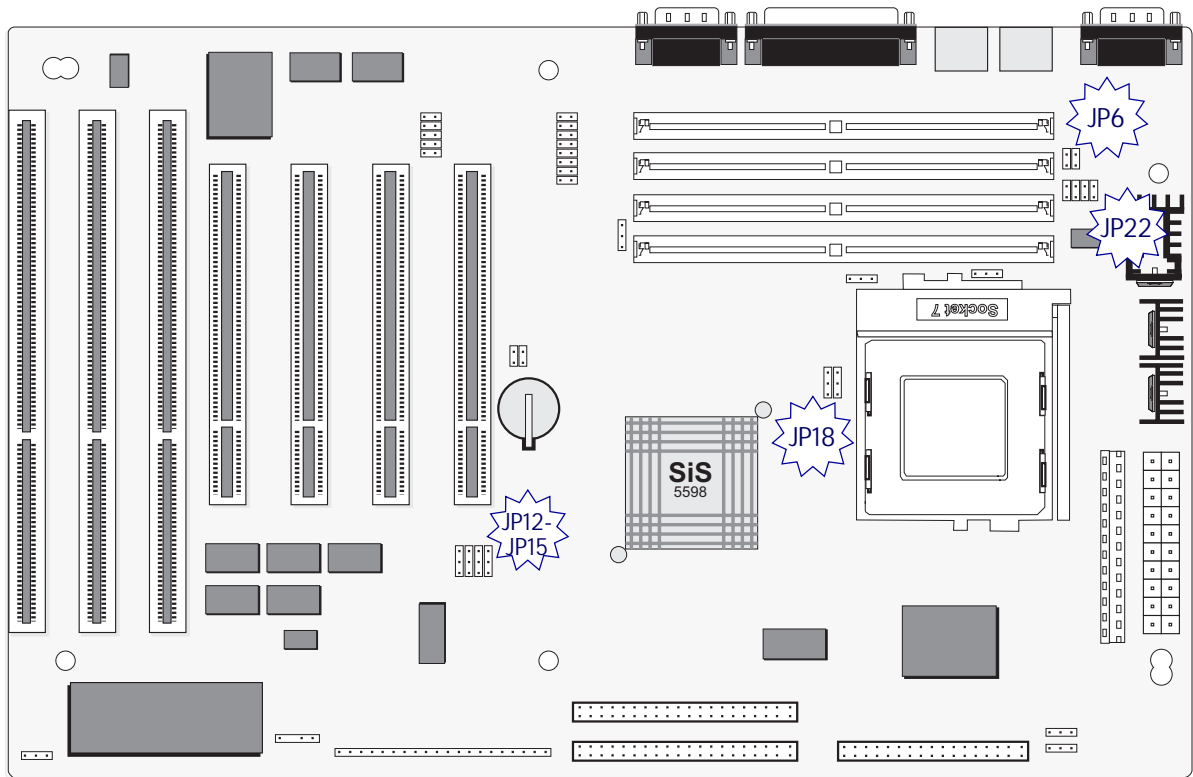

Adding An IDE Peripheral

This section covers some aspects of installing internal IDE peripheral devices as they relate to the mainboard. The onboard Enhanced IDE controller supports up to four devices, two per IDE channel. The primary hard disk drive in most systems is an IDE device. You may want to install more hard disks, a CD-ROM drive or combination of these and other devices. This mainboard supports both PIO and UltraDMA modes, which it can detect automatically. You can install a mix of devices. With the Setup Defaults loaded in the CMOS Setup utility, the system will automatically detect and configure multiple devices of whatever mode.

IDE Transfer Modes

Hard disk read and write operations are executed via the mainboard chipset. The transfer of data between the hard disk and the system takes place using one of a number of transfer modes – either one of several PIO modes or UltraDMA mode.

Although there are several PIO Modes (0 through 4), and this mainboard supports all of them, most current hard disk and CD-ROM drives use either Mode 3 or 4. The greater the mode number, the faster the transfer rate, so you should use the fastest mode the device can operate at. With Setup Defaults loaded in the CMOS Setup Utility, the system will automatically detect the fastest mode a device can use and set it for that mode.

UltraDMA is another transfer method that provides even faster data transfer than PIO modes. To use it you must install a drive that uses this transfer method. Drives that use PIO Mode transfer can not use the UltraDMA setting.

The settings for drive modes are in the Integrated Peripherals section of the CMOS Setup utility. The screen illustration at right shows the Setup Defaults settings.

```

ROM PCI/ISA BIOS (P5SJ-A)
INTEGRATED PERIPHERALS
AWARD SOFTWARE, INC.

IDE HDD Block Mode      : Enabled
OnChip Primary PCI IDE : Enabled
OnChip Secondary PCI IDE : Enabled
IDE Primary Master PIO  : Auto
IDE Primary Slave PIO   : Auto
IDE Secondary Master PIO : Auto
IDE Secondary Slave PIO : Auto
Primary Master UltraDMA : Auto
Primary Slave UltraDMA  : Auto
Secondary Master UltraDMA : Auto
Secondary Slave UltraDMA : Auto

Onboard FDD Controller  : Enabled
Onboard Serial Port 1   : 3F8/IRQ4
Onboard Serial Port 2   : 2F8/IRQ3
UART 2 Mode             : Standard
Onboard Parallel Port   : 378/IRQ7
Onboard Parallel Mode   : SPP

USB Controller          : Disabled

ESC : Quit           ↑↓+ : Select Item
F1  : Help          PU/PD/+/- : Modify
F5  : Old Values   (Shift)F2 : Color
F6  : Load BIOS Defaults
F7  : Load Setup Defaults

```

CMOS Setup Utility –

Integrated Peripherals

The illustration above shows the Setup Defaults settings for this screen. You can install IDE devices under these settings and the system will automatically detect and set the best mode for each device.

You can also set the transfer mode for each device manually, although we recommend using the default settings unless you have a reason not to and you know what you are doing.

Installing IDE Devices

The mainboard’s Enhanced IDE controller supports four devices in two channels, IDE1 and IDE2. These are called the Primary and Secondary IDE channels.

Each channel supports two devices, the first device is called the Master device and the second the Slave device. You must configure any IDE device you install to operate as one or the other. To find out how to configure the device you plan to install you should refer to the manual that comes with the device. You may need to set jumpers or switches to configure it.

IDE Cables

The mainboard comes with one IDE ribbon cable to connect two devices to the mainboard. If you need to install devices on the second channel you will need to get another IDE cable. These are a standard and inexpensive item that you can generally find at any computer supply store. One edge of the cable is colored to indicate the Pin 1 side. When you connect the cable to the mainboard and a device you must orient the cable so that this colored edge is at the Pin 1 side of the connector you are attaching it to.

The mainboard IDE connectors have an orientation cut-out to ensure correct orientation, and the supplied cable has an orientation tab on the side of the connector. Some IDE cables do not have this tab and therefore are not forced to use the correct orientation. You should check that any cable you buy has orientation tabs on the side of the connectors. If you get a cable that does not have them, make sure the cable is correctly oriented when you attach it to the board and the device.

IDE cables have three connectors on them, one at each end and one in-between, closer to one of the ends. When you install a device on the second channel, attach the lone end to the IDE2 connector on the mainboard. The two connectors that are closer to each other are for connecting to IDE devices. The connector on the end is for the Master device and the connector in the middle is for the Slave device.

IDE Devices & CMOS Setup

When you install a new hard disk drive its parameters will be automatically detected by the BIOS and entered in the Standard CMOS Setup section of the CMOS Setup utility if you use the Setup Defaults, which automatically detect any new hard disk drive. All other devices do not use drive parameters and will not show up in the device list on this page.

Adjusting Display Memory

The 5598 model of this mainboard has an onboard display card that uses a part of the system memory as display memory. The default display memory is 1MB. You can increase this in 1MB increments up to a total of 4MB.

Use the ChipSet Features Setup section of the CMOS Setup utility to change the amount of system memory allotted to display memory. The 'VGA Shared Memory Size' line sets the display memory. The screen on the next page shows this.

Remember, when you increase the amount of display memory you are subtracting from the system memory.

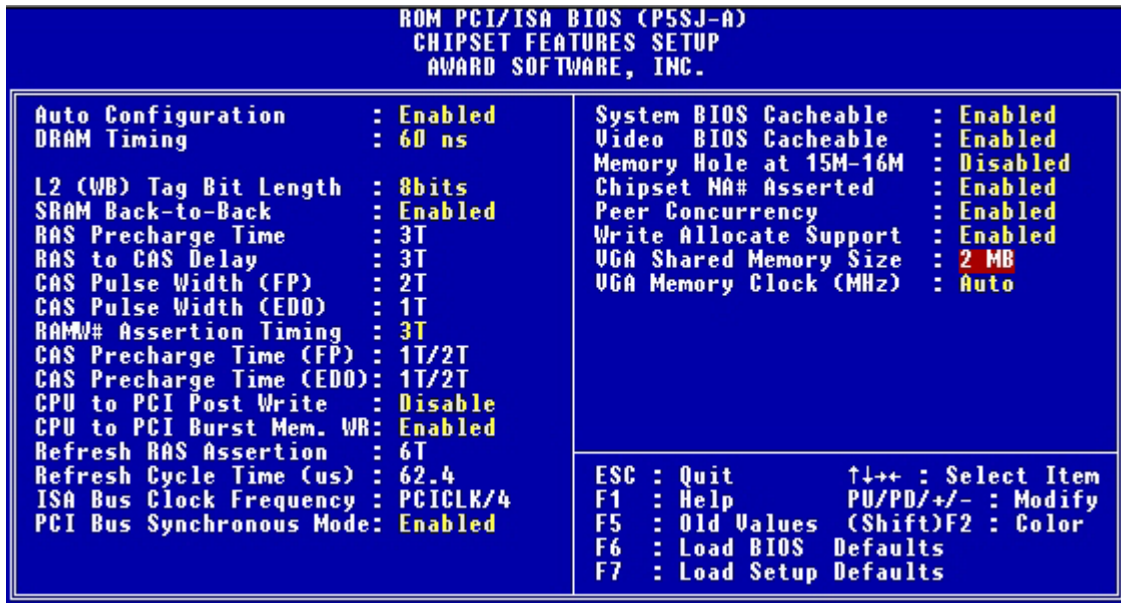

CMOS Setup Utility –

ChipSet Features Setup

The VGA Shared Memory Size line sets the size of the display memory. The display memory is drawn from the total available system memory. The options are 1, 2, 3 or 4MB.

In This Section:

Jumper Summary

Connector Summary

CPU Information

Memory Configurations

CMOS Setup Utility

P5SJ–A Reference Information

This section is a summary of the P5SJ–A’s specifications and settings. It includes the following:

- Jumper Configuration Summary
- Connector Summary
- Supported CPUs
- System Memory Configuration Specifications
- CMOS Setup Utility Summary

Using This Section

The information in this section is presented in a summary format to make it easy to find specific information. If you need related explanations, please refer to the topics earlier in the manual.

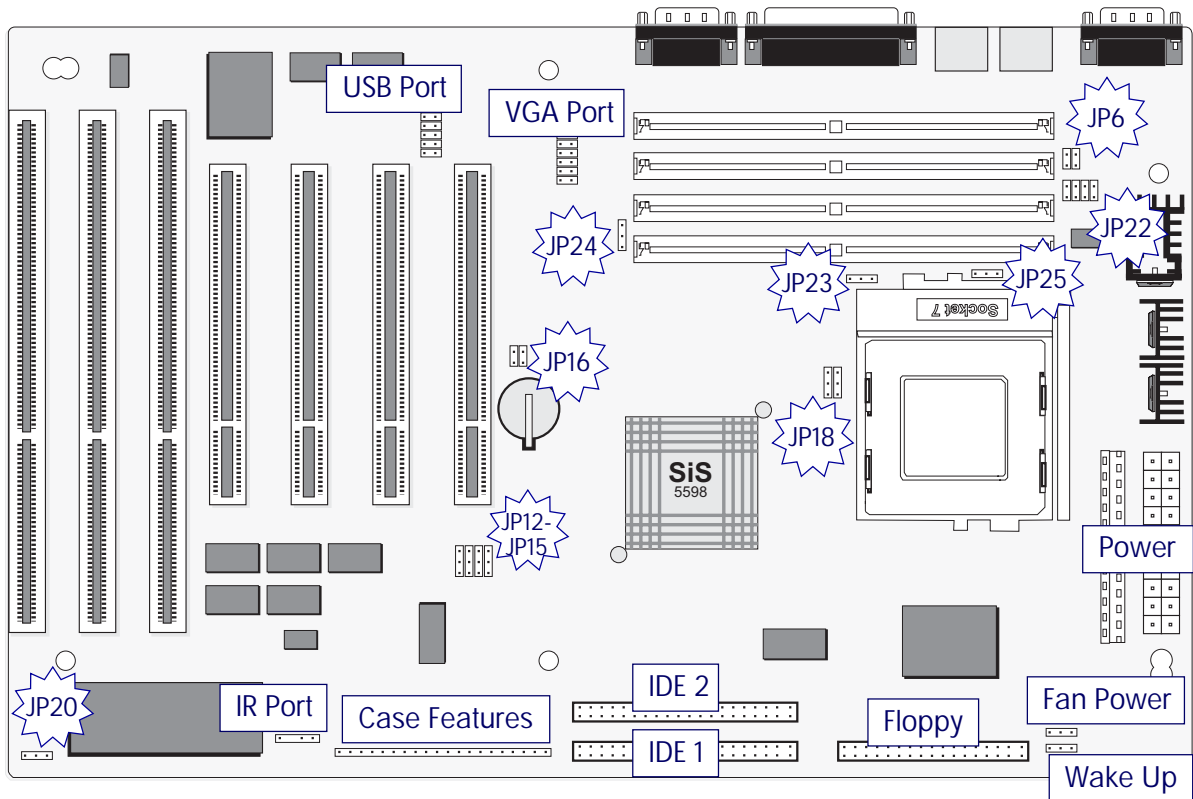

Jumper & Connectors

The illustration above shows the location of the jumpers, port and other connectors on the P5SJ-A mainboard.



In practice, for an Off setting on a two-pin jumper, place the cap over one pin so that it doesn't get lost.

Jumper Configuration Summary

This section lists the jumper setting options for this mainboard. The settings are listed as follows:

- The two pins shorted by a jumper cap on a three-or-more-pin jumper, e.g. 1-2
or
- For a two-pin jumper, On, if the cap is in place, and Off, if a cap is not in place.

In the jumper illustrations, the Pin 1 position is shaded and the jumpers, shown in a “bird’s eye” view, look like this:



A jumper with a cap in position looks like this:



The default settings are noted in the summary tables. Unless you need to upgrade the CPU, disable the onboard VGA feature or upgrade the BIOS, you should not need to change them.

Miscellaneous Jumper Settings

Function	Jumper	Settings		
CMOS Setup Record	JP16	Normal Clear	1-2 2-3	Default
Flash BootBlock	JP20	Disable Enable	2-3 1-2	Default
Onboard VGA	JP23,24,25	Enable Disable	23:1-2, 24:2-3, 25:1-2 23:2-3, 24:1-2, 25:2-3	Default

CPU Jumper Settings

Function	Jumper	Settings						
External Speed	JP12–JP15	50MHz	12:2-3, 13:2-3, *14:1-2	25MHz,	15:2-3			
		55MHz	12:2-3, 13:2-3, *14:1-2	27.5MHz,	15:1-2			
		60MHz	12:2-3, 13:1-2, *14:1-2	33.3MHz,	15:2-3			
		Default	66.6MHz	12:1-2, 13:2-3, *14:1-2	30MHz,	15:2-3		
		75MHz	12:2-3, 13:1-2, *14:1-2	37.5MHz,	15:1-2			
*The 2-3 setting for JP14 sets the PCI bus clock to 32MHz for all speeds.								
Internal Clock Factor	JP18	1.5x	BF0:1-2 BF1: 1-2					
		2.0x	BF0:2-3BF1: 1-2			Default		
		2.5x	BF0:2-3BF1: 2-3					
		3.0x	BF0:1-2 BF1: 2-3					
I/O Voltage	JP6	STD 3.3V	1-2	Default				
		VRE 3.52V	3-4					
Core Voltage On= Cap On Off= Cap Off	JP22	Single*	1-2	3-4	5-6	7-8	Default	
		2.54V	On	On	On	On		
		2.84V	Off	On	Off	On		
		2.94V	On	Off	Off	Off		
		3.24V	On	On	Off	Off		
		3.34V	Off	On	On	Off		
* Single means the core voltage is the same as the I/O voltage								

External Clock Speed

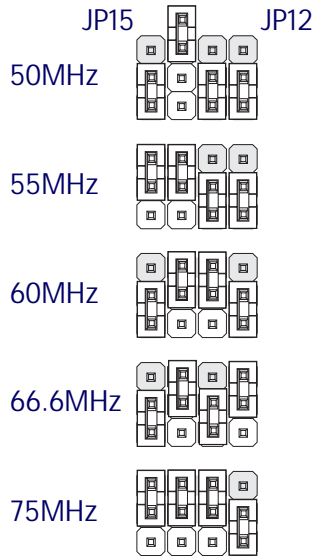

Clock Factor

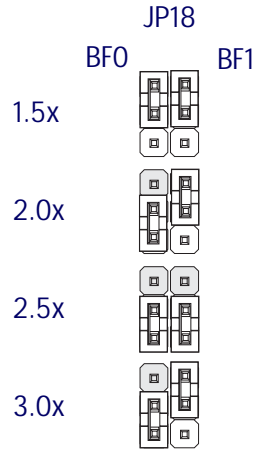

CPU I/O Voltage (Vio)

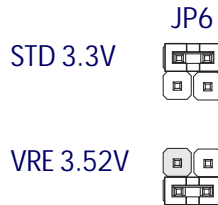

CPU Core Voltage (Vcore)

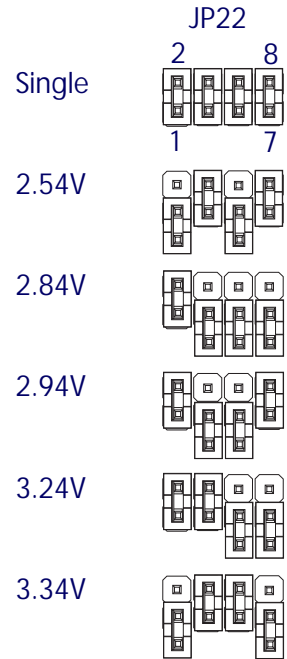

Onboard Connectors

Name	Function	Information
IDE1	First IDE channel	40-pin connector connects to 2-device cable; End device is Primary Master, middle is Slave
IDE2	Second IDE channel	40-pin connector connects to 2-device cable; End device is Secondary Master, middle is Slave
Floppy	Floppy disk drive	34-pin connector connects to 2-device cable; End device is Drive A:, middle is Drive B:
COM1	Serial Port 1	Onboard 9-pin serial port is COM1, can be set to COM3
COM2	Serial Port 2	Onboard 9-pin serial port is COM2, can be set to COM4
CN2	Parallel port	Standard 25-pin parallel Printer port
Mouse	PS/2 Mouse port	Standard PS/2 mouse port
KB	PS/2 Keyboard port	Standard PS/2 keyboard port
J6/VGA	Onboard VGA port	16-pin connector connects to external VGA port
USB1	Onboard USB port	10-pin USB connector connects to dual external USB port
PW1	AT Power Connector	Connects to AT power supply leads P8 & P9
PW2	ATX Power Connector	Connects to ATX power supply lead
J1	CPU Fan Connector	Connects to 2 or 3-pin power lead from CPU fan
CN3/SIR	Infrared port	4-pin connector connects to optional IR port module
J8	Wakeup Connector	Connects to external wakeup signal cable
J7	Feature connector	Connects to case features: Pin 1-3: Power On LED; Pin 4-5: ACPI Switch; Pin 6-8: ACPI LED; Pin 9-10: Reset Switch Pin 11-12: Keyboard Lock; Pin 13-16: Speaker Pin 17-18: Hard Disk LED; Pin 19-20: Power Switch

J7: Case Features Connector

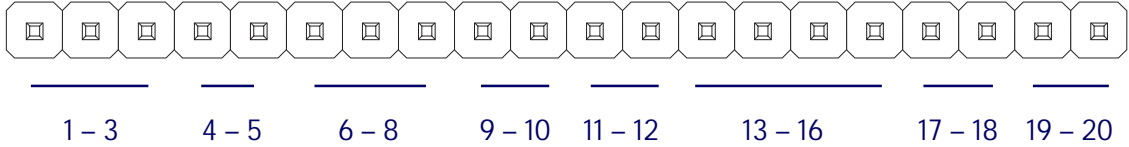

- Pin 1-3: Power On LED
- Pin 4-5: ACPI Switch
- Pin 6-8: ACPI LED
- Pin 9-10: Reset Switch
- Pin 11-12: Keyboard Lock
- Pin 13-16: Speaker
- Pin 17-18: Hard Disk LED
- Pin 19-20: Power Switch

Supported CPUs

This mainboard can use CPUs from Intel, Cyrix, IBM and AMD. The board’s switching CPU power design and jumper configuration options allow the use of all Pentium class processors from all three vendors, including those with MMX features. The correct jumper configuration automatically sets the required power configuration for the CPU.

Processor speeds from 90 to 200MHz are supported as well as single and split voltage CPUs.

Intel CPUs Supported:

Pentium P54C, P54CTB, P54CT, P55C

Cyrix & IBM CPUs Supported:

6X86, 6X86L

AMD CPUs Supported:

K5, K6

Interpreting CPU Markings

If you are installing a CPU and you do not have the information needed to set the CPU jumper configuration you can usually get it from the markings on the CPU. The following information is a guide to reading the markings.

AMD K5 CPU Markings

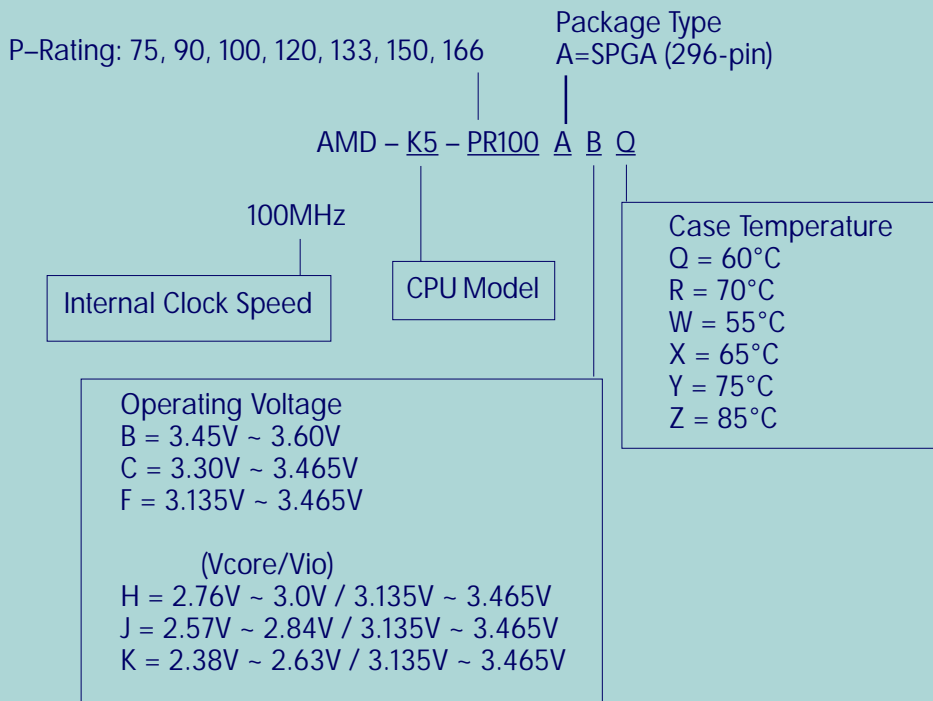

Cyrix 6x86 CPU Markings

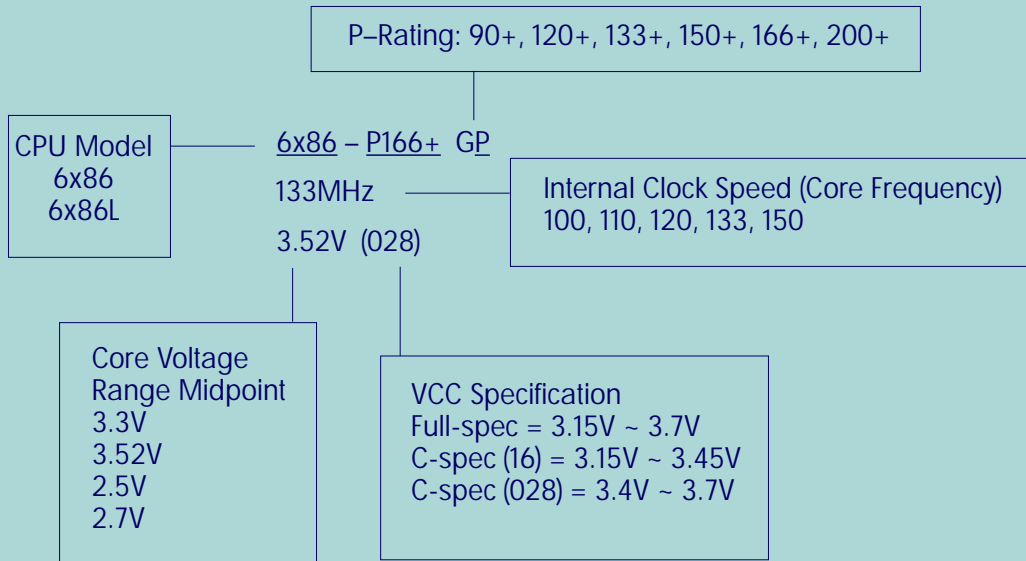

System Memory Specifications

The memory subsystem has four SIMM sockets divided into two banks, SIMM1 & SIMM2 and SIMM3 & SIMM4. Install SIMM modules in pairs using the same type and speed in each bank. This mainboard supports both Fast Page Mode (FPM) and EDO DRAM modules. Modules from 2MB to 128MB are supported, either single or double-sided. Total supported memory capacity is 256MB.

Memory Configurations

You can install any system memory combination as long as you follow the basic requirement of installing identical modules in both sockets of a bank, i.e.:

- All modules must be 5 Volt
- Same module memory capacity, e.g. 16MB (MegaBytes)
- Same DRAM memory type e.g. EDO
- Same operating speed, e.g. 60ns (nanoseconds)

Other than this requirement, there is no limitation on the variety of possible combinations, so they are not listed here.

Note: It is possible to install more memory than the board supports, e.g. four 128MB modules would total 512MB, but the board would ignore 256MB of that. Do not install more than 256MB on this mainboard.

CMOS Setup Utility Summary

This section explains the entries in the CMOS Setup Utility program. This utility is permanently stored on the BIOS chip on the mainboard. It creates a record of the mainboard’s and some system configuration information and stores it in battery-supported memory on the mainboard. This record must be intact and accurate in order for the mainboard to operate.

After a brief explanation of how to operate the utility there is a summary of the entries and options for all sections of the utility. Under normal conditions, once your system is set up, you should have little or no need to use this utility.

Using the CMOS Setup Utility

This mainboard uses the Award system BIOS. It is stored in a Flash ROM memory chip on the mainboard. The BIOS uses a software program, also stored on the same chip to create a system configuration record which is saved in a small amount of special “CMOS” memory on the mainboard.

Accessing The CMOS Setup Utility

When you turn on your computer, a message appears on the screen indicating you can run the Setup program by pressing the Del key (it’s on the keypad.) The message appears after the POST (Power On Self Test).

If you want to run Setup but you don’t respond in time before the message disappears, you can reset the system by pressing the Ctrl + Alt + Delete keys at the same time, or by pushing the system Reset button. The message will then reappear.

After you press the Del or Delete key the program menu screen will appear, displaying the Setup utility section names and some command instructions.



Menu Commands

If you look at the lower portion of the screen illustration you’ll see a section that lists the control commands for this level of the program. You execute a command by pressing the key for that command. The program commands are :

Quit

This command will close the Setup program when you press the ESC key.

Save & Exit Setup

This will save the current settings and close the Setup program when you press the F10 key.

Select Item

You can use the arrow keys on your keyboard to move around the screen and select a menu item. An item is highlighted when it is selected.

Change Color

Change the program color scheme by pressing Shift + F2.

The section at the bottom of the screen displays a brief explanation of a highlighted menu item’s function.

There are six main sections to the Setup program:

- Standard CMOS Setup
Date, time, disk drive, video display and error handling
- BIOS Features Setup
System customization features and video display settings
- Chipset Features Setup
Chipset settings, memory configuration feature for specialized add-on cards and VGA memory configuration
- Power Management Setup
Sets up the “green” power management features
- PNP/PCI Configuration
PCI expansion slot and system resource settings
- Integrated Peripherals
IDE channels and onboard port settings

The other main menu items interact with these main sections:

- Load BIOS Defaults
Loads minimum settings from the BIOS ROM.
- Load Setup Defaults
Loads standard settings from the BIOS ROM.
- Password Setting
Sets system password which is configured by the Security Option item in BIOS Features Setup.
- IDE HDD Auto Detection
Automatically detects the drive parameters of any installed IDE hard disk drives and enters them automatically in the Standard CMOS Setup.
- HDD Low Level Format
Hard disk drive low level format program. See the warning in the section about using this.
- Save & Exit Setup
Saves the current settings and exits the program.
- Exit Without Saving
Discards any changes made during the current session and exits the program.

To enter a section of the Setup program, highlight the menu item and press the Enter key.

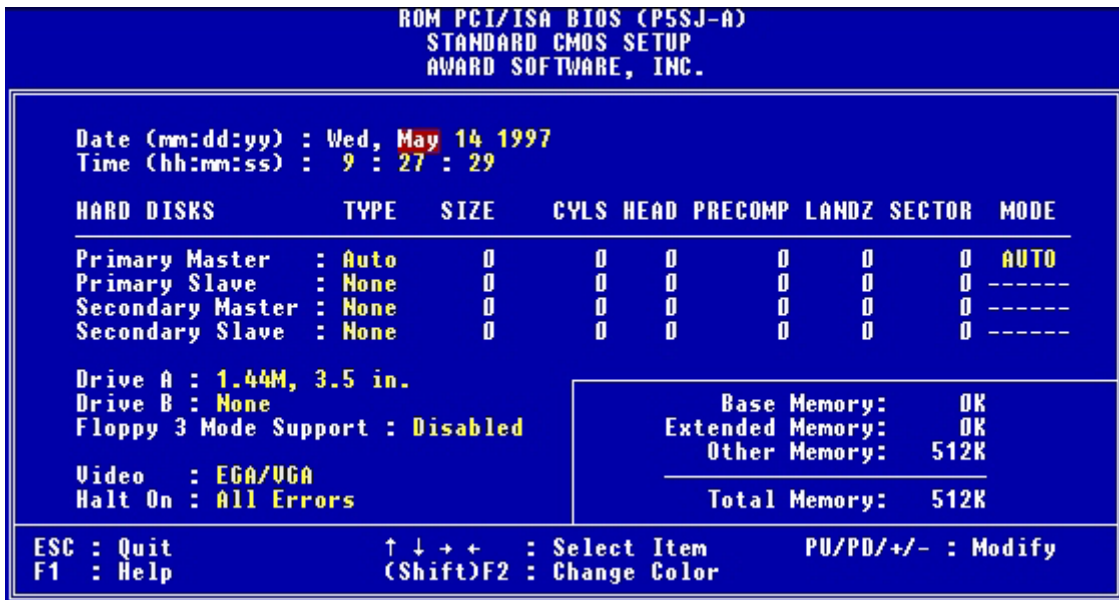

Standard CMOS Setup

To enter this section, highlight this menu item in the main menu and press the Enter key. The screen above will appear.

Note:

Due to a technical limitation in producing the illustration of this screen, the memory figures shown are not standard. Your system will display the figures for the memory installed on the mainboard.

Menu Commands

If you look at the lower portion of the screen illustration you'll see a section that lists the control commands for this level of the program. You execute a command by pressing the key for that command. The program commands are :

Quit

This command will close the Setup program when you press the ESC key.

Help

This displays information about the highlighted item when you press the F10 key.

Select Item

You can use the arrow keys on your keyboard to move around the screen and select a menu item. An item is highlighted when it is selected.

Change Color

You can change the program color scheme by pressing Shift + F2.

Modify

To change the setting of a highlighted selection you can press either the Page Up (PU) and Page Down (PD) keys or the Plus (+) and Minus (–) keys. Pressing a key once will switch to the next setting option for the selected item.

If your mainboard is already installed in a working system the proper entries are already entered on this screen and you shouldn’t change them except for adjusting the Date and Time entries if necessary.

Date & Time

The first two lines on the screen are the date and time settings for the system clock.

Hard Disk Type & Parameters

Use the IDE HDD Auto Detection feature to automatically enter the drive parameters of IDE hard disk drives in these fields. If you have only SCSI hard disk drives installed in your system leave the settings here at None. Only hard disk information needs to be entered here. Other IDE devices do not use this.

For an IDE hard drive, you should set the entry to “Auto” and the BIOS will automatically detect all drive information needed. You can use the IDE HDD Auto Detection utility described later to supervise the auto-detection process. If you want to do this, leave the drive set to “None”. You can also enter specifications manually by using the “User” option.

Large Hard Disk Modes

The last of the drive parameter entries – Mode – has four options, Normal, LBA, Large and Auto. The Mode settings are for IDE hard disks only.

Normal

For IDE hard disks of 528MB or less.

LBA

This stands for Logical Block Addressing, the current standard access mode for large IDE hard disk drives. It allows the use of hard disks larger than 528MB by causing the IDE controller to translate between the logical address it creates and the hard disk’s actual physical address. The maximum drive size supported is 8.4GB.

Large

For 1GB or smaller drives with more than 1024 cylinders and no LBA support. This access mode causes the Operating System to treat the drive as if it has fewer than 1024 cylinders by dividing the cylinder total in half and doubling the number of heads. Drives needing this mode are less common.

Most large IDE hard disk drives currently available use the LBA mode. Use the AUTO setting to automatically detect the correct mode for new drives.

Floppy Disk Drives

The two floppy disk drive items set the drive type for drives A and B, and must be entered manually. The options are

360KB, 5.25 in.

1.2MB, 5.25 in.

720KB, 3.5 in.

1.44MB, 3.5 in.

2.88MB, 3.5 in.

None

Highlight the listing after each drive name and select the appropriate entry.

Floppy 3Mode Support

3Mode is a Japanese 3.5-inch floppy disk drive specification. If this type of drive is installed you should enable this feature. The default setting is Disabled.

Video Display Types

You set this according to the type of display card in your system. This should normally be left on EGA/VGA. The options are:

EGA/VGA

Mono (for Hercules or MDA)

CGA 40

CGA 80

Error Handling

The last line – Halt On – sets when the system stops if an error occurs. The options are:

All Errors (Default)

No Errors

All, But Keyboard

All, But Diskette

All, But Disk/Key

When you are finished in this section, exit to the main menu screen by pressing the Esc key.

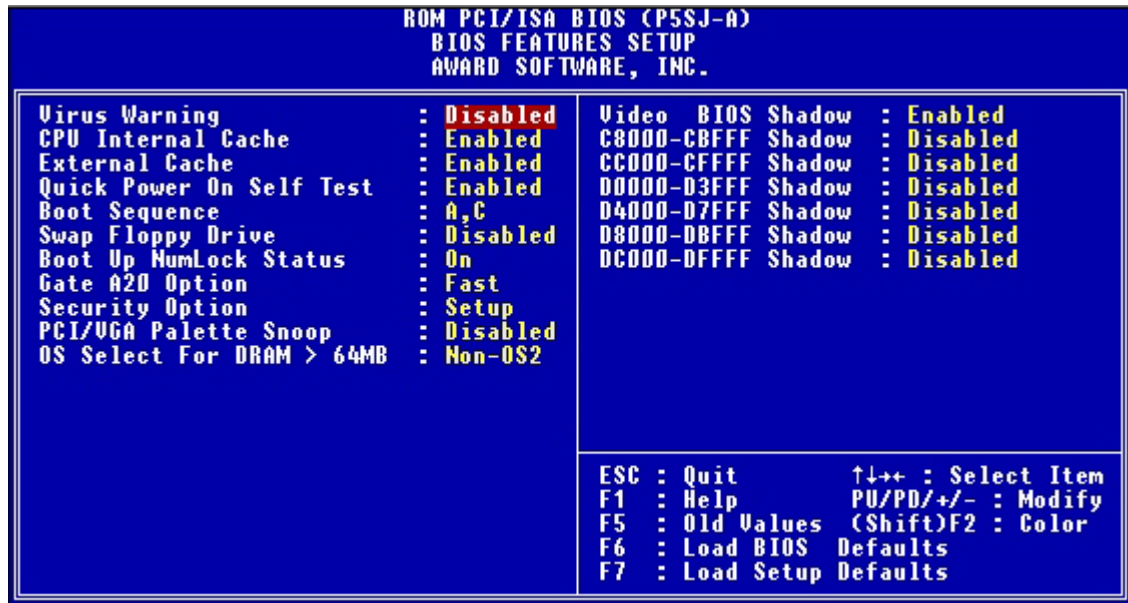

BIOS Features Setup

To enter this section of the Setup program, highlight this menu item in the main menu and press the Enter key. The following screen will appear.

Menu Commands

If you look at the lower portion of the screen illustration you’ll see a section that lists the control commands for this level of the program. You execute a command by pressing the key for that command. The program commands are :

Quit

This command will close the Setup program when you press the ESC key.

Help

This displays information about the highlighted item when you press the F10 key.

Select Item

You can use the arrow keys on your keyboard to move around the screen and select a menu item. An item is highlighted when it is selected.

Modify

To change the setting of a highlighted selection you can press either the Page Up (PU) and Page Down (PD) keys or the Plus (+) and Minus (-) keys. Pressing a key once will switch to the next setting option for the selected item.

Change Color

Change the program color scheme by pressing Shift + F2.

Old Values

If you make changes during the current session and you don’t want to keep them you can recall the last set of saved values for this page by pressing the F5 key.

Load BIOS Defaults

Pressing F6 loads the BIOS Default settings for this page.

Load Setup Defaults

Pressing F7 loads the Setup Default settings for this page.

If your mainboard is already installed in a working system the proper entries are already entered on this screen and you shouldn’t change them.

Virus Warning

This protects the primary hard disk's boot sector and partition table from infection. Any attempt to write to them will halt the system and produce a warning message. If this happens, you can either allow the system to continue or stop it and boot from a virus-free bootable floppy disk. Use an anti-virus utility located on the floppy disk to check the hard disk. The default setting is Disabled.

CPU Internal Cache

This enables CPU's Level 1 built-in cache. Leave it enabled to maintain system performance. The default setting is Enabled.

External Cache

This is the Level 2 external cache of either 256KB or 512KB. Leave this enabled to maintain system performance. The default setting is Enabled.

Quick Power On Self Test

This feature speeds up the Power On Self Test (POST) by skipping some parts of the POST. If your system is functioning normally, you can enable this feature to speed the boot process. The default setting is Enabled.

Boot Sequence

This determines the order in which the computer checks drives for an operating system. This allows you to configure the system to boot from a CD-ROM drive as well as the drive A: floppy disk drive and the drive C: boot hard disk. The options are:

A, C

C,A

C, CD-ROM, A

CD-ROM, C, A

Swap Floppy Drive

This switches the floppy drive assignments so that drive A is treated as drive B; and drive B; as drive A; under DOS. The default setting is Disabled.

Boot Up NumLock Status

This item allows you to select which mode the numeric keypad on an IBM-compatible extended keyboard is set to when the computer boots up. The options are:

On – Numeric keypad mode (Default)

Off – Cursor control mode

Gate A20 Option

This sets the gate A20 control. The two options are:

Fast – Recommended default

Normal

Security Option

This sets when password protection is active. The two options are:

System – Password required at boot up

Setup – Password controls access to Setup utility

You create a password using the Password Setting option in the main menu. If no password is set, the system ignores this item.

PCI/VGA Palette Snoop

If your video display card has an MPEG card attached to the feature connector, the display may invert to black on white while booting. If this happens with your system configuration, enable this feature to correct the problem. The default setting is Disabled.

OS Select For DRAM >64MB

If your system has more than 64MB of system memory installed and you are using the OS/2 operating system, set this to the OS2 setting. The default setting, Non-OS2, is for all other operating systems.

Video BIOS Shadow

This copies the video display card BIOS into system DRAM to increase display speed and is required for system performance. The default setting is Enabled.

Shadowing Address Ranges

The next six lines, from C8000-CBFFF Shadow to DC000-DFFFF Shadow are address ranges for shadowing other expansion card ROMs. If there are any expansion cards with ROMs installed in your system, you have to know the address range they use to shadow them specifically. The default setting for all of these is Disabled.

When you are done in this section press the Esc key to return to the main menu.

```

ROM PCI/ISA BIOS (P5SJ-A)
CHIPSET FEATURES SETUP
AWARD SOFTWARE, INC.

Auto Configuration      : Enabled
DRAM Timing            : 60 ns

L2 (WB) Tag Bit Length : 8bits
SRAM Back-to-Back      : Enabled
RAS Precharge Time     : 3T
RAS to CAS Delay       : 3T
CAS Pulse Width (FP)   : 2T
CAS Pulse Width (EDO)  : 1T
RAMW# Assertion Timing : 3T
CAS Precharge Time (FP) : 1T/2T
CAS Precharge Time (EDO) : 1T/2T
CPU to PCI Post Write  : Disable
CPU to PCI Burst Mem. WR: Enabled
Refresh RAS Assertion  : 6T
Refresh Cycle Time (us) : 62.4
ISA Bus Clock Frequency : PCICLK/4
PCI Bus Synchronous Mode: Enabled

System BIOS Cacheable  : Enabled
Video BIOS Cacheable   : Enabled
Memory Hole at 15M-16M : Disabled
Chipset NA# Asserted   : Enabled
Peer Concurrency       : Enabled
Write Allocate Support  : Enabled
VGA Shared Memory Size : 2 MB
VGA Memory Clock (MHz) : Auto

ESC : Quit          ↑↓↓+ : Select Item
F1  : Help         PU/PD/+/- : Modify
F5  : Old Values   (Shift)F2 : Color
F6  : Load BIOS Defaults
F7  : Load Setup Defaults

```

Chipset Features Setup

To enter this section of the Setup program, highlight this menu item in the main menu and press the Enter key. The following screen will appear.

Menu Commands

The menu commands for this screen are the same as for the BIOS Features Setup screen.

Auto Configuration

Everything on this screen except for the Memory Hole and VGA Shared Memory Size item is set automatically when auto-configuration is active. If you disable it you can set the values manually, although we recommend against this. Don't disable automatic configuration unless you know what you are doing. The default setting is Enabled.

Memory Hole At 15M–16M

Some special add-on cards require a 1MB address space between 15 and 16MB. The documentation for this type of card should tell you if it needs this. The default setting is Disabled.

VGA Shared Memory Size

This sets the size of the 5598 model’s onboard video display memory. The video memory is drawn from the total installed system memory. The options are 1MB, 2MB, 3MB and 4MB. The default setting is 1MB.

To return to the main menu press the Esc key.

```

ROM PCI/ISA BIOS (P5SJ-A)
POWER MANAGEMENT SETUP
AWARD SOFTWARE, INC.

Power Management      : Disable
PM Control by APM    : Yes
Video Off Method     : DPMS
MODEM Use IRQ       : NA

Doze Mode            : Disable
Standby Mode        : Disable
Suspend Mode        : Disable
HDD Power Down      : Disable

** Wake Up Events In Doze & Standby **
COM Ports Activity  : Enabled
LPT Ports Activity  : Enabled
HDD Ports Activity  : Enabled
UGA Activity        : Disabled

** Power Down & Resume Events **
IRQ3 (COM 2)       : ON
IRQ4 (COM 1)       : ON
IRQ5 (LPT 2)       : ON
IRQ6 (Floppy Disk) : ON
IRQ7 (LPT 1)       : ON
IRQ8 (RTC Alarm)   : OFF
IRQ9 (IRQ2 Redir)  : ON
IRQ10 (Reserved)   : ON
IRQ11 (Reserved)   : ON
IRQ12 (PS/2 Mouse) : ON
IRQ13 (Coprocessor): ON
IRQ14 (Hard Disk)  : ON
IRQ15 (Reserved)   : ON

ESC : Quit          ↑↓+ : Select Item
F1  : Help          PU/PD/+/- : Modify
F5  : Old Values   (Shift)F2 : Color
F6  : Load BIOS Defaults
F7  : Load Setup Defaults

```

Power Management Setup

To enter this section of the Setup program, highlight this menu item in the main menu and press the Enter key. The following screen will appear.

Menu Commands

The menu commands for this screen are the same as for the BIOS Features Setup screen.

What Power Management Does

Power management lets you set up your computer to save electricity when it is not actively in use by putting the system into progressively greater power saving modes. In the power management scheme there are four system states which proceed in the following sequence:

Normal

Doze

Standby

Suspend

Power Management

This controls the entire power management scheme. There are four settings:

User Defined

You set the power saving options manually

Disable

Turns off all power management

Max Saving

Maximizes power saving by activating maximum power saving settings after one minute of system inactivity

Min Saving

Produces less power saving by activating moderate power saving settings after one hour of system inactivity

PM Control By APM

When this is set to Yes the Advanced Power Management feature in Microsoft Windows controls power management operation. The default setting is No.

Video Off Method

This governs monitor power saving by controlling how power management blanks the monitor screen. The default setting blanks the screen and turns off vertical and horizontal scanning and requires a monitor with “green” features. If you don’t have this type of monitor, use the Blank option. DPMS (Display Power Management System) allows the BIOS to control the video display card if the card has the DPMS feature.

V/H SYNC+Blank	(Default)
Blank	(Non-green monitor, less saving)
DPMS	(Display card must support DPMS)

Video Off Option

This governs in what modes the video display gets turned off. The options are:

Susp,Stby-> Off	(Off in Suspend & Standby)
Susp-> Off	(Off in Suspend)
All Modes Off	(Off in Doze, Suspend & Standby)
Always On	(No video shut off)

Modem Use IRQ

If you have a modem installed in your system you can enter which IRQ it is using so that APM can control it. The default setting is NA (Not Applicable).

Doze Mode

This sets the period of system inactivity after which the system goes into Doze mode, the most limited power saving state. The settings range from 1 minute to 1 hour and can be set manually when power management is in User Define mode. The default setting is Disabled. When the system goes into power saving mode, power management will skip to the next mode in the sequence if this is disabled.

Standby Mode

This sets the period of system inactivity after which the system goes into Standby mode, the intermediate power saving state. The settings range from 1 minute to 1 hour and can be set manually when power management is in User Define mode. The default setting is Disabled. When the system goes into power saving mode, power management will skip to the next mode in the sequence if this is disabled.

Suspend Mode

This sets the period of system inactivity after which the system goes into Suspend mode, the maximum power saving state. The settings range from 1 minute to 1 hour and can be set manually when power management is in User Define mode. The default setting is Disabled. When the system goes into power saving mode, power management will skip to the next mode in the sequence if this is disabled.

HDD Power Down

This shuts down IDE hard disks that support a power saving mode after a specified time period. The settings range from 1 to 15 minutes and can be set manually when power management is in User Define mode. HDD Power Down does not affect SCSI hard disks. The default setting is Disabled.

The system automatically resumes from any power saving mode when there is system activity such as keyboard activity or an IRQ wake-up event like mouse movement or a modem ring.

Wake Up Events In Doze & Standby

The system will resume from Doze or Standby mode if there is any activity on the ports listed here when set to ‘Enabled’. The system won’t wake up from such activity if an item is set to ‘Disabled’. The default settings are:

COM Ports Activity	Enabled
LPT Ports Activity	Enabled
HDD Ports Activity	Enabled
VGA Activity	Enabled

Power Down & Resume Event

This section allows setting the resume status of individual IRQs. When set to ON, activity will wake up the system. When set to OFF activity is ignored.

When you are finished you can press the Esc key to return to the main menu.

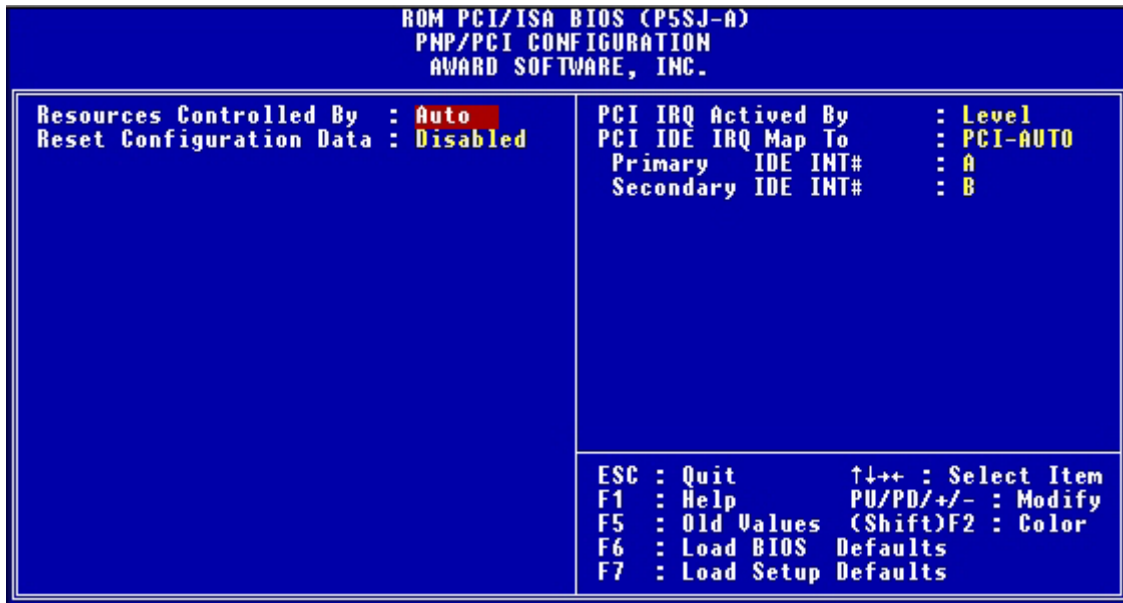

PNP/PCI Configuration

To enter this section of the Setup program, highlight this menu item in the main menu and press the Enter key. The following screen will appear.

Menu Commands

The menu commands for this screen are the same as for the BIOS Features Setup screen.

```

ROM PCI/ISA BIOS (P5SJ-A)
PNP/PCI CONFIGURATION
AWARD SOFTWARE, INC.

Resources Controlled By : Manual
Reset Configuration Data : Disabled

IRQ-3 assigned to : PCI/ISA PnP
IRQ-4 assigned to : PCI/ISA PnP
IRQ-5 assigned to : PCI/ISA PnP
IRQ-7 assigned to : PCI/ISA PnP
IRQ-9 assigned to : PCI/ISA PnP
IRQ-10 assigned to : PCI/ISA PnP
IRQ-11 assigned to : PCI/ISA PnP
IRQ-12 assigned to : PCI/ISA PnP
IRQ-14 assigned to : PCI/ISA PnP
IRQ-15 assigned to : PCI/ISA PnP
DMA-0 assigned to : PCI/ISA PnP
DMA-1 assigned to : PCI/ISA PnP
DMA-3 assigned to : PCI/ISA PnP
DMA-5 assigned to : PCI/ISA PnP
DMA-6 assigned to : PCI/ISA PnP
DMA-7 assigned to : PCI/ISA PnP

PCI IRQ Activated By : Level
PCI IDE IRQ Map To : PCI-AUTO
Primary IDE INT# : A
Secondary IDE INT# : B

ESC : Quit          ↑↓↓+ : Select Item
F1  : Help          PU/PD/+/- : Modify
F5  : Old Values   (Shift)F2 : Color
F6  : Load BIOS Defaults
F7  : Load Setup Defaults

```

Resources Controlled By

When this line is set to Auto the BIOS will automatically configure IRQ and DMA resources. This is the recommended setting. If you set this line to Manual, the screen changes as shown above and allows manual configuration. In general you should only need to do this if you are installing an ISA card that requires manual configuration.

Reset Configuration Data

The default setting is 'Disabled'. If you need to clear the ESCD data, set this to 'Enabled'. The data will clear automatically and the BIOS will reset this line to the 'Disabled' setting.

PCI Activated By

The default setting is ‘Level’. The other setting is ‘Edge’. This entry affects all the PCI slots. Use the default setting.

PCI IDE IRQ Map To

Most of PCI IDE cards are non-PCI compliant. This line defines the IRQ Routing to make them work properly. The available settings are:

PCI-AUTO (default)

ISA

PCI-SLOT1

PCI-SLOT2

PCI-SLOT3

PCI-SLOT4

If you set this option to ‘ISA’, both the ‘Primary IDE INT#’ and ‘Secondary IDE INT#’ options below it will not appear on the screen.

Primary/Secondary IDE INT#

These define the primary/secondary IDE INT# of a PCI IDE card. The setting options are:

A (Primary IDE INT# default)

B (Secondary IDE INT# default)

C

D

When you are finished you can press the Esc key to return to the main menu.

Load BIOS Defaults

To invoke this command highlight it in the main menu and press Enter. A message will appear asking if you want to load the BIOS defaults. Press the Y key and then the Enter key. The BIOS default settings will load. Press the N key if you want to cancel.

This loads a set of troubleshooting default values permanently stored in the BIOS ROM. The settings are not optimal and turn off all the performance features. Standard CMOS Setup is not affected by this command.

Load Setup Defaults

To invoke this command highlight it in the main menu and press Enter. A message will appear asking if you want to load the Setup defaults. Press the Y key and then the Enter key. The Setup default settings will load. Press the N key if you want to cancel.

This loads a set of optimized default values permanently stored in the BIOS ROM. Use this command to load default settings for normal system operation. Standard CMOS Setup is not affected by this command.

```

ROM PCI/ISA BIOS (P5SJ-A)
INTEGRATED PERIPHERALS
AWARD SOFTWARE, INC.

IDE HDD Block Mode      : Enabled
OnChip Primary PCI IDE : Enabled
OnChip Secondary PCI IDE : Enabled
IDE Primary Master PIO  : Auto
IDE Primary Slave PIO   : Auto
IDE Secondary Master PIO : Auto
IDE Secondary Slave PIO : Auto
Primary Master UltraDMA : Auto
Primary Slave UltraDMA  : Auto
Secondary Master UltraDMA : Auto
Secondary Slave UltraDMA : Auto

Onboard FDD Controller  : Enabled
Onboard Serial Port 1   : 3F8/IRQ4
Onboard Serial Port 2   : 2F8/IRQ3
UART 2 Mode             : Standard
Onboard Parallel Port   : 378/IRQ7
Onboard Parallel Mode   : SPP

USB Controller          : Disabled

ESC : Quit           ↑↓+ : Select Item
F1  : Help          PU/PD/+/- : Modify
F5  : Old Values    (Shift)F2 : Color
F6  : Load BIOS Defaults
F7  : Load Setup Defaults

```

Integrated Peripherals

This section sets the IDE transfer mode for all IDE channels. It also configures the other onboard ports.

Menu Commands

The menu commands for this screen are the same as for the BIOS Features Setup screen.

IDE HDD Block Mode

Enables hard disk drive block transfer mode . The setting options are:

Enabled (default)

Disabled

On-Chip Primary/Secondary PCI IDE

Enables or Disables the Primary or Secondary PCI controllers. Selecting “Disabled” releases IRQ14.

Enabled (default)

Disabled

IDE Primary/Secondary Master/ Slave PIO

These four lines set the hard disk PIO transfer mode, which affects the hard disk data transfer rate. The system will auto-detect the PIO mode of a device in any of these positions when they are set to ‘Auto’, the recommended setting. Alternatively, you can set the mode manually. Modes 0 to 4 are supported.

Primary/Master Master/Slave Ultra DMA

These four lines enable hard disk UltraDMA transfer mode, which requires a drive that supports this data transfer method. The system will auto-detect an UltraDMA device in any of these four positions when they are set to ‘Auto’, the recommended setting. The other setting is ‘Disabled’. You can leave these set to Auto without effect if there are no UltraDMA devices installed.

Onboard FDD Controller

Enables or Disables the onboard Floppy Drive controller.

Onboard Serial Port 1/2

Sets the I/O address for serial ports 1/2.

3F8/IRQ4 (default of Onboard serial Port 1)

2F8/IRQ3(default of Onboard serial Port 2)

3E8/IRQ4

2E8/IRQ3

Disabled

UART 2 Mode

Sets mode for the second serial port UART. If you select an IR module type, the second serial port will not be available. The setting options are:

Standard (default) – (used by COM2 serial port)

ASKIR

HPSIR

Onboard Parallel Port

Sets the I/O address for the onboard parallel port. The setting options are:

378H/IRQ7 (default)

Disabled

278H/IRQ5

3BCH/IRQ7

If you set this option to ‘Disabled’, the ‘Onboard Parallel Mode’ option below will not appear on the screen.

Onboard Parallel Mode

Selects the parallel port mode. The setting options are:

SPP (default)

ECP/EPP

EPP/SPP

ECP

If you set this option to ‘SPP’ or ‘EPP/SPP’, the ‘ECP Mode Use DMA’ option will not appear on the screen. If you set this option to ‘SPP’ or ‘ECP’, the ‘Parallel Port EPP Type’ option will not appear on the screen.

ECP Mode Use DMA

Selects the ECP Mode DMA channel. The setting options are:

3 (default)

1

Parallel Port EPP Type

Sets the EPP protocol version. The setting options are:

EPP 1.7 (default)

EPP 1.9

USB Controller

Enables or Disables the onboard USB port controller.

Password Setting

To invoke this command highlight it in the main menu and press Enter. A message will appear prompting you to enter a password.

Type in a password. The password is case sensitive, and can be up to 8 alphanumeric characters. Press Enter when you finish typing in the password.

If you typed in a password, the message “Confirm Password” will appear. Confirm the password by typing it again and pressing Enter. The message box will close.

If you don’t want to set a password after you invoke this command, or if you want to eliminate an existing password, press Enter without typing anything else. The message “Password Disabled” will appear and the message box will close.

When you set a password, the Security Option line in BIOS Features Setup controls when the password is required. You can set the option to require the password when the system boots up or when calling up the Setup utility. The mainboard ships with no password.

IDE HDD Auto Detection

When you install an IDE hard drive, you can use this feature to automatically detect the drive parameters and enter them in the appropriate Hard Disk section of Standard CMOS Setup. However, since the Auto settings in Standard CMOS Setup perform the same function, you do not need to configure IDE hard disk drives from here. If you want to use this feature, highlight it in the main menu and press the Enter key.

Save And Exit Setup

When you select this and press Enter the values entered during the current session are recorded in CMOS memory.

Exit Without Saving

When you select this and press Enter the Setup Utility closes without recording any changes made during the current session.