



# P4Twins-HDTV

## User Manual

Version 1.1

Published November 2005

Copyright©2005 ASRock INC. All rights reserved.

---

**Copyright Notice:**

No part of this manual may be reproduced, transcribed, transmitted, or translated in any language, in any form or by any means, except duplication of documentation by the purchaser for backup purpose, without written consent of ASRock Inc.

Products and corporate names appearing in this manual may or may not be registered trademarks or copyrights of their respective companies, and are used only for identification or explanation and to the owners' benefit, without intent to infringe.

**Disclaimer:**

Specifications and information contained in this manual are furnished for informational use only and subject to change without notice, and should not be constructed as a commitment by ASRock. ASRock assumes no responsibility for any errors or omissions that may appear in this manual.

With respect to the contents of this manual, ASRock does not provide warranty of any kind, either expressed or implied, including but not limited to the implied warranties or conditions of merchantability or fitness for a particular purpose.

In no event shall ASRock, its directors, officers, employees, or agents be liable for any indirect, special, incidental, or consequential damages (including damages for loss of profits, loss of business, loss of data, interruption of business and the like), even if ASRock has been advised of the possibility of such damages arising from any defect or error in the manual or product.



This device complies with Part 15 of the FCC Rules. Operation is subject to the following two conditions:

- (1) this device may not cause harmful interference, and
- (2) this device must accept any interference received, including interference that may cause undesired operation.

**ASRock Website:** <http://www.asrock.com>

---

## Contents

<b>1 Introduction .....</b>	<b>5</b>
1.1 Package Contents .....	5
1.2 Specifications .....	6
1.3 Motherboard Layout .....	9
1.4 ASRock 8CH I/O .....	10
<b>2 Installation .....</b>	<b>11</b>
Pre-installation Precautions .....	11
2.1 CPU Installation .....	12
2.2 Installation of CPU Fan and Heatsink .....	12
2.3 Installation of Memory Modules (DIMM) .....	13
2.4 Expansion Slots .....	14
2.5 Jumpers Setup .....	15
2.6 Onboard Headers and Connectors .....	15
2.7 Installing VGA_HDTV Panel to Enjoy HDTV (High- Definition TV) / TV Support Function .....	19
2.7.1 HDTV (High-Definition TV) Support Function .....	20
2.7.2 TV Support Function .....	22
2.8 Untied Overclocking Technology .....	23
2.9 Serial ATA (SATA) Hard Disks Installation .....	23
2.10 Making a SATA Driver Diskette For SATA Operation in "RAID" Mode .....	23
<b>3 BIOS SETUP UTILITY .....</b>	<b>25</b>
3.1 Introduction .....	25
3.1.1 BIOS Menu Bar .....	25
3.1.2 Navigation Keys .....	26
3.2 Main Screen .....	26
3.3 Advanced Screen .....	27
3.3.1 CPU Configuration .....	27
3.3.2 Chipset Configuration .....	28
3.3.3 ACPI Configuration .....	31
3.3.4 IDE Configuration .....	32
3.3.5 PCIPnP Configuration .....	34
3.3.6 Floppy Configuration .....	35
3.3.7 Super IO Configuration .....	35
3.3.8 USB Configuration .....	37
3.4 Hardware Health Event Monitoring Screen .....	37
3.5 Boot Screen .....	38
3.5.1 Boot Settings Configuration .....	38

---

3.6	Security Screen .....	39
3.7	Exit Screen .....	40
<b>4</b>	<b>Software Support .....</b>	<b>41</b>
4.1	Install Operating System .....	41
4.2	Support CD Information .....	41
4.2.1	Running Support CD .....	41
4.2.2	Drivers Menu .....	41
4.2.3	Utilities Menu .....	41
4.2.4	Contact Information .....	41

---

## Chapter 1 Introduction

Thank you for purchasing ASRock P4Twins-HDTV motherboard, a reliable motherboard produced under ASRock's consistently stringent quality control. It delivers excellent performance with robust design conforming to ASRock's commitment to quality and endurance. In this manual, chapter 1 and 2 contain introduction of the motherboard and step-by-step guide to the hardware installation. Chapter 3 and 4 contain the configuration guide to BIOS setup and information of the Support CD.



Because the motherboard specifications and the BIOS software might be updated, the content of this manual will be subject to change without notice. In case any modifications of this manual occur, the updated version will be available on ASRock website without further notice. You may find the latest memory and CPU support lists on ASRock website as well. ASRock website <http://www.asrock.com>

### 1.1 Package Contents

ASRock P4Twins-HDTV Motherboard

(Micro ATX Form Factor: 9.6-in x 9.6-in, 24.4 cm x 24.4 cm)

ASRock P4Twins-HDTV Quick Installation Guide

ASRock P4Twins-HDTV Support CD

One 80-conductor Ultra ATA 66/100/133 IDE Ribbon Cable

One Ribbon Cable for a 3.5-in Floppy Drive

One Serial ATA (SATA) Data Cable (Optional)

One Serial ATA (SATA) HDD Power Cable (Optional)

One ASRock 8CH I/O

One ASRock MR Card (Optional)

One ASRock VGA\_HDTV Panel

One VGA\_2x8 Cable

One AV/S\_2x3 Cable

---

## 1.2 Specifications

<b>Platform</b>	- Micro ATX Form Factor: 9.6-in x 9.6-in, 24.4 cm x 24.4 cm
<b>CPU</b>	- Socket 478 for Intel® Pentium® 4 / Celeron® D (Prescott, Northwood) processor - Chipset capable to FSB 1066 MHz - Supports Hyper-Threading Technology (see <b>CAUTION 1</b> ) - Supports Untied Overclocking Technology (see <b>CAUTION 2</b> )
<b>Chipset</b>	- Northbridge: ATI™ Radeon® Xpress 200 chipset - Southbridge: ULI® M1573
<b>Memory</b>	- 2 x DDR DIMM slots - Support DDR400/333/266 - Max. capacity: 4GB - 2 x DDRII DIMM slots - Support DDRII667/533 - Max. capacity: 4GB
<b>Hybrid Booster</b>	- CPU Frequency Stepless Control (see <b>CAUTION 3</b> ) - ASRock U-COP (see <b>CAUTION 4</b> ) - Boot Failure Guard (B.F.G.)
<b>Expansion Slot</b>	- 2 x PCI slots - 1 x PCI Express x 16 slot - 1 x PCI Express x 1 slot - 1 x AMR slot
<b>Graphics</b>	- Integrated ATI™ Radeon® X300 based graphics - DirectX 9.0 VGA - Pixel Shader 2.0 - Max. shared memory 128MB
<b>Audio</b>	- Realtek ALC850 7.1 channel AC'97 audio codec
<b>LAN</b>	- Realtek PHY RTL8201CL - Speed: 10/100Mb Ethernet - Supports Wake-On-LAN
<b>Rear Panel I/O</b>	ASRock 8CH I/O - 1 x PS/2 Mouse - 1 x PS/2 Keyboard Port - 1 x Serial Port: COM1 - 1 x Parallel Port (ECP/EPP Support) - 4 x Ready-to-Use USB 2.0 Ports - 1 x RJ-45 Port - Audio Jack: Side Speaker/Rear Speaker/Central Bass/Line in/Front Speaker/Microphone (see <b>CAUTION 5</b> )

---

<b>Connector</b>	<ul style="list-style-type: none"> <li>- 4 x Serial ATA 1.5Gb/s connectors (Supports RAID 0, 1, JBOD) (No support for "Hot Plug" function)</li> <li>- 2 x ATA133 IDE connector (supports 4 x IDE devices)</li> <li>- 1 x Floppy connector</li> <li>- 1 x Game header</li> <li>- 1 x IR header</li> <li>- 1 x VGA header</li> <li>- 1 x TV-OUT header (supports YPbPr and AV)</li> <li>- CPU/Chassis FAN connector</li> <li>- 20 pin ATX power connector</li> <li>- 4 pin 12V power connector</li> <li>- CD in header</li> <li>- Front panel audio connector</li> <li>- 2 x USB 2.0 headers (support 4 USB 2.0 ports) (see <b>CAUTION 6</b>)</li> </ul>
<b>BIOS Feature</b>	<ul style="list-style-type: none"> <li>- 4Mb AMI BIOS</li> <li>- AMI Legal BIOS</li> <li>- Supports "Plug and Play"</li> <li>- ACPI 1.1 Compliance Wake Up Events</li> <li>- Supports jumperfree</li> <li>- SMBIOS 2.3.1 Support</li> </ul>
<b>Support CD</b>	- Drivers, Utilities, AntiVirus Software
<b>Hardware Monitor</b>	<ul style="list-style-type: none"> <li>- CPU Temperature Sensing</li> <li>- Chassis Temperature Sensing</li> <li>- CPU Overheat Shutdown to Protect CPU Life</li> <li>- CPU Fan Tachometer</li> <li>- Chassis Fan Tachometer</li> <li>- Voltage Monitoring: +12V, +5V, +3.3V, Vcore</li> </ul>
<b>OS</b>	- Microsoft® Windows® 2000/XP/XP 64-bit compliant
<b>Certifications</b>	- FCC, CE, WHQL

---

---

### **CAUTION!**

1. About the setting of "Hyper Threading Technology", please check page 28.
2. This motherboard supports Untied Overclocking Technology. Please read "Untied Overclocking Technology" on page 23 for details.
3. Although this motherboard offers stepless control, it is not recommended to perform over-clocking. Frequencies other than the recommended CPU bus frequencies may cause the instability of the system or damage the CPU.
4. While CPU overheat is detected, the system will automatically shutdown. Before you resume the system, please check if the CPU fan on the motherboard functions properly and unplug the power cord, then plug it back again. To improve heat dissipation, remember to spray thermal grease between the CPU and the heatsink when you install the PC system.
5. For microphone input, this motherboard supports both stereo and mono modes. For audio output, this motherboard supports 2-channel, 4-channel, 6-channel, and 8-channel modes. Please check the table on page 10 for proper connection.
6. Power Management for USB 2.0 works fine under Microsoft® Windows® XP SP1 or SP2 / 2000 SP4.



## 1.3 Motherboard Layout

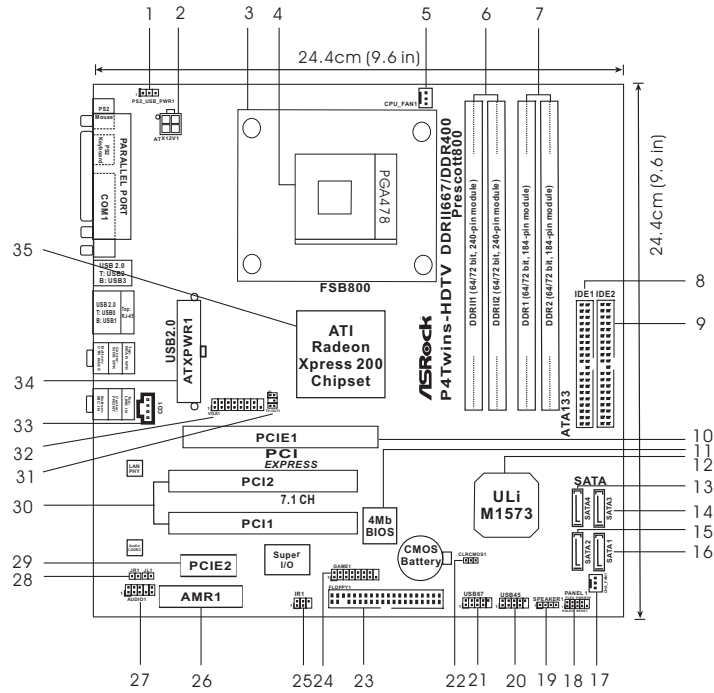

- |    |  |    |                                       |
|----|--|----|---------------------------------------|
| 1  | PS2_USB_PWR1 Jumper  | 18 | System Panel Header (PANEL1)          |
| 2  | ATX 12V Connector (ATX12V1)                                | 19 | Chassis Speaker Header (SPEAKER 1)    |
| 3  | CPU Heatsink Retention Module                              | 20 | USB 2.0 Header (USB45, Blue)          |
| 4  | CPU Socket   | 21 | USB 2.0 Header (USB67, Blue)          |
| 5  | CPU Fan Connector (CPU_FAN1)                               | 22 | Clear CMOS Jumper (CLRCMOS1)          |
| 6  | 2 x 240-pin DDRII DIMM Slots<br>(DDR11_1, DDR11_2; Yellow) | 23 | Floppy Connector (FLOPPY1)            |
| 7  | 2 x 184-pin DDR DIMM Slots<br>(DDR1, DDR2; Blue)           | 24 | Game Port Header (GAME1)              |
| 8  | Primary IDE Connector (IDE1, Blue)                         | 25 | Infrared Module Connector (IR1)       |
| 9  | Secondary IDE Connector (IDE2, Black)                      | 26 | AMR Slot (AMR1)                       |
| 10 | PCI EXPRESS Slot (PCIE1)                                   | 27 | Front Panel Audio Header (AUDIO1)     |
| 11 | BIOS FW H Chip   | 28 | JR1 / JL1 Jumpers                     |
| 12 | South Bridge Controller                                    | 29 | PCI EXPRESS Slot (PCIE2)              |
| 13 | Fourth Serial ATA Connector (SATA4, black)                 | 30 | PCI Slots (PCI1- 2)                   |
| 14 | Third Serial ATA Connector (SATA3, black)                  | 31 | TV-OUT Header (TV-OUT1)               |
| 15 | Secondary Serial ATA Connector (SATA2, black)              | 32 | VGA Header (VGA1)                     |
| 16 | Primary Serial ATA Connector (SATA1, blue)                 | 33 | Internal Audio Connector: CD1 (Black) |
| 17 | Chassis Fan Connector (CHA_FAN1)                           | 34 | ATX Power Connector (ATXPWR1)         |
|    |  | 35 | North Bridge Controller               |

## 1.4 ASRock 8CH I/O

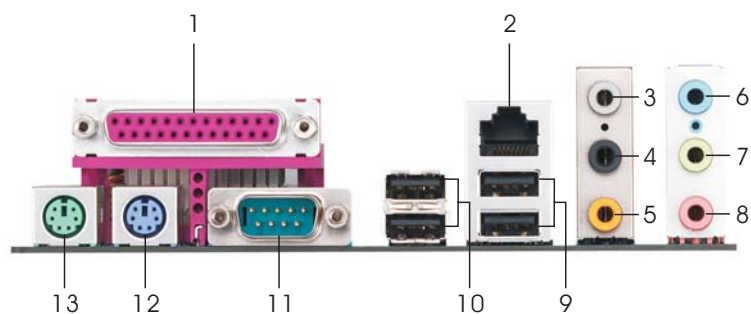

- |                           |                                |
|---------------------------|--------------------------------|
| 1 Parallel Port           | 8 Microphone (Pink)            |
| 2 RJ-45 Port              | 9 USB 2.0 Ports (USB01)        |
| 3 Side Speaker (Gray)     | 10 USB 2.0 Ports (USB23)       |
| 4 Rear Speaker (Black)    | 11 Serial Port: COM1           |
| 5 Central / Bass (Orange) | 12 PS/2 Keyboard Port (Purple) |
| 6 Line In (Light Blue)    | 13 PS/2 Mouse Port (Green)     |
| *7 Front Speaker (Lime)   |                                |

\* If you use 2-channel speaker, please connect the speaker's plug into "Front Speaker Jack". See the table below for connection details in accordance with the type of speaker you use.

**TABLE for Audio Output Connection**

Audio Output Channels	Front Speaker (No. 7)	Rear Speaker (No. 4)	Central / Bass (No. 5)	Side Speaker (No. 3)
2	V	--	--	--
4	V	V	--	--
6	V	V	V	--
8	V	V	V	V

---

## Chapter 2 Installation

**P4Twins-HDTV** is a Micro ATX form factor (9.6-in x 9.6-in, 24.4 cm x 24.4 cm) motherboard. Before you install the motherboard, study the configuration of your chassis to ensure that the motherboard fits into it.

### Pre-installation Precautions

Take note of the following precautions before you install motherboard components or change any motherboard settings.

1. Unplug the power cord from the wall socket before touching any component.
2. To avoid damaging the motherboard components due to static electricity, NEVER place your motherboard directly on the carpet or the like. Also remember to use a grounded wrist strap or touch a safety grounded object before you handle components.
3. Hold components by the edges and do not touch the ICs.
4. Whenever you uninstall any component, place it on a grounded anti-static pad or in the bag that comes with the component.



Before you install or remove any component, ensure that the power is switched off or the power cord is detached from the power supply. Failure to do so may cause severe damage to the motherboard, peripherals, and/or components.

---

## 2.1 CPU Installation

- Step 1. Unlock the socket by lifting the lever up to a 90° angle.
- Step 2. Position the CPU directly above the socket such that its marked corner matches the base of the socket lever.
- Step 3. Carefully insert the CPU into the socket until it fits in place.



The CPU fits only in one correct orientation. DO NOT force the CPU into the socket to avoid bending of the pins.

- Step 4. When the CPU is in place, press it firmly on the socket while you push down the socket lever to secure the CPU. The lever clicks on the side tab to indicate that it is locked.



STEP 1:  
Lift The Socket Lever Up to 90°

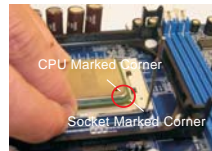

STEP 2/STEP 3:  
Match The CPU Marked Corner  
to The Socket Marked Corner



STEP 4:  
Push Down And Lock  
The Socket Lever

## 2.2 Installation of CPU Fan and Heatsink

This motherboard adopts 478-pin CPU socket to support Intel® Pentium® 4 / Celeron® CPU. It requires larger heatsink and cooling fan to dissipate heat. You also need to spray thermal grease between the CPU and the heatsink to improve heat dissipation. Make sure that the CPU and the heatsink are securely fastened and in good contact with each other. Then connect the CPU fan to the CPU\_FAN connector (CPU\_FAN1, see p.9 No. 5). For proper installation, please kindly refer to the instruction manuals of the CPU fan and the heatsink.

---

## 2.3 Installation of Memory Modules (DIMM)

This motherboard is equipped with two 184-pin DDR (Double Data Rate) DIMM slots and two 240-pin DDRII (Double Data Rate) DIMM slots.



1. It is not allowed to install DDR into DDRII slot or DDRII into DDR slot; otherwise, this motherboard and DIMM may be damaged.
2. It is not allowed to install both DDR and DDRII to this motherboard at the same time; otherwise, this motherboard and DIMM may be damaged.



Please make sure to disconnect power supply before adding or removing DIMMs or the system components.

Step 1. Unlock a DIMM slot by pressing the retaining clips outward.

Step 2. Align a DIMM on the slot such that the notch on the DIMM matches the break on the slot.

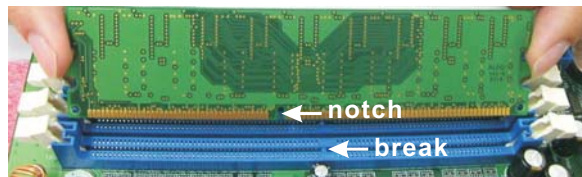
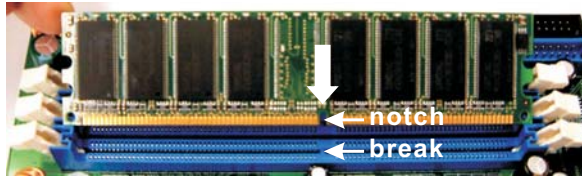

The DIMM only fits in one correct orientation. It will cause permanent damage to the motherboard and the DIMM if you force the DIMM into the slot at incorrect orientation.

Step 3. Firmly insert the DIMM into the slot until the retaining clips at both ends fully snap back in place and the DIMM is properly seated.

---

## 2.4 Expansion Slots (PCI, AMR, and PCI Express Slots)

There are 2 PCI slots, 1 AMR slot and 2 PCI Express slot on this motherboard.

**PCI slots:** PCI slots are used to install expansion cards that have the 32-bit PCI interface.

**AMR slot:** AMR slot is used to insert an ASRock MR card (optional) with v.92 Modem functionality.

**PCI Express Slots:** PCIE1 (PCI Express x16 slot) is used for PCI Express cards with x16 lane width graphics cards.

PCIE2 (PCI Express x1 slot) is used for PCI Express cards, such as Gigabit LAN card, SATA2 card, etc.

### Installing an expansion card

- Step 1. Before installing the expansion card, please make sure that the power supply is switched off or the power cord is unplugged. Please read the documentation of the expansion card and make necessary hardware settings for the card before you start the installation.
- Step 2. Remove the system unit cover (if your motherboard is already installed in a chassis).
- Step 3. Remove the bracket facing the slot that you intend to use. Keep the screws for later use.
- Step 4. Align the card connector with the slot and press firmly until the card is completely seated on the slot.
- Step 5. Fasten the card to the chassis with screws.
- Step 6. Replace the system cover.

## 2.5 Jumpers Setup

The illustration shows how jumpers are setup. When the jumper cap is placed on pins, the jumper is "Short". If no jumper cap is placed on pins, the jumper is "Open". The illustration shows a 3-pin jumper whose pin1 and pin2 are "Short" when jumper cap is placed on these 2 pins.

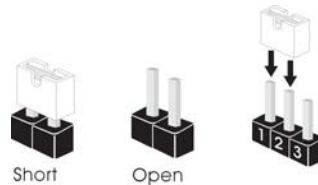

Jumper	Setting	Description
PS2_USB_PWR1 (see p.9 No. 1)	<div style="display: flex; justify-content: space-around;"> <div style="text-align: center;"> <p>1_2</p> <p>+5V</p> </div> <div style="text-align: center;"> <p>2_3</p> <p>+5VSB</p> </div> </div>	Short pin2, pin3 to enable +5VSB (standby) for PS/2 or USB wake up events.

Note: To select +5VSB, it requires 2 Amp and higher standby current provided by power supply.

JR1(see p.9 No. 28)	
JL1(see p.9 No. 28)	

Note: If the jumpers JL1 and JR1 are short, both the front panel and the rear panel audio connectors can work.

Clear CMOS (CLR CMOS1, 3-pin jumper) (see p.9 No. 22)	<div style="display: flex; justify-content: space-around;"> <div style="text-align: center;"> <p>1_2</p> <p>Default</p> </div> <div style="text-align: center;"> <p>2_3</p> <p>Clear CMOS</p> </div> </div>
---	---

Note: CLR CMOS1 allows you to clear the data in CMOS. The data in CMOS includes system setup information such as system password, date, time, and system setup parameters. To clear and reset the system parameters to default setup, please turn off the computer and unplug the power cord from the power supply. After waiting for 15 seconds, use a jumper cap to short pin2 and pin3 on CLR CMOS1 for 5 seconds. However, please do not clear the CMOS right after you update the BIOS. If you need to clear the CMOS when you just finish updating the BIOS, you must boot up the system first, and then shut it down before you do the clear-CMOS action.

## 2.6 Onboard Headers and Connectors



Onboard headers and connectors are NOT jumpers. Do NOT place jumper caps over these headers and connectors. Placing jumper caps over the headers and connectors will cause permanent damage of the motherboard!

FDD connector  
(33-pin FLOPPY1)  
(see p.9 No. 23)



Note: Make sure the red-striped side of the cable is plugged into Pin1 side of the connector.

**Primary IDE Connector (Blue)**

(39-pin IDE1, see p.9, No. 8)

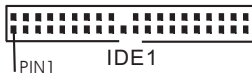

**Secondary IDE Connector (Black)**

(39-pin IDE2, see p.9, No. 9)



connect the blue end  
to the motherboard



connect the black end  
to the IDE devices

80-conductor ATA 66/100/133 cable

Note: If you use only one IDE device on this motherboard, please set the IDE device as "Master". Please refer to the instruction of your IDE device vendor for the details. Besides, to optimize compatibility and performance, please connect your hard disk drive to the primary IDE connector (IDE1, blue) and CD-ROM to the secondary IDE connector (IDE2, black).

**Serial ATA Connectors**

(SATA1: see p.9 No. 16)

(SATA2: see p.9 No. 15)

(SATA3: see p.9 No. 14)

(SATA4: see p.9 No. 13)



These four Serial ATA (SATA) connectors support SATA data cables for internal storage devices. The current SATA interface allows up to 1.5 Gb/s data transfer rate.

**Serial ATA (SATA)  
Data Cable**



Either end of the SATA data cable can be connected to the SATA hard disk or the SATA connector on the motherboard.

**Serial ATA (SATA)  
Power Cable**

(Optional)



Please connect the black end of SATA power cable to the power connector on each drive. Then connect the white end of SATA power cable to the power connector of the power supply.

**VGA\_2x8 Cable**



Please connect either end of VGA\_2X8 cable to J1 jumper of VGA\_HDTV panel and the other end to VGA1 header of this motherboard.

**AV/S\_2x3 Cable**



Please connect either end of AV/S\_2x3 cable to J2 jumper of VGA\_HDTV panel and the other end to TV-OUT header of this motherboard.



**VGA Header**  
(VGA1: see p.9 No. 32)

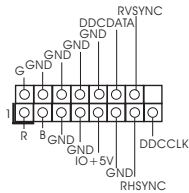

Please connect either end of VGA\_2X8 cable to VGA header.

**TV-OUT Header**  
(TV-OUT1: see p.9 No. 31)

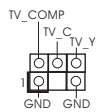

Please connect either end of AV/S\_2X3 cable to TV-OUT header.

**USB 2.0 Header**  
(9-pin USB67)  
(see p.9 No. 21)

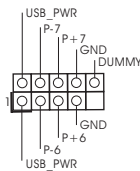

ASRock 8CH I/O accommodates 4 default USB 2.0 ports. If those USB 2.0 ports on the I/O panel are not sufficient, this USB 2.0 header is available to support 2 additional USB 2.0 ports.

**USB 2.0 Header**  
(9-pin USB45)  
(see p.9 No. 20)

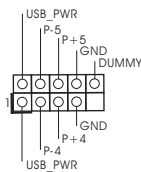

ASRock 8CH I/O accommodates 4 default USB 2.0 ports. If those USB 2.0 ports on the I/O panel are not sufficient, this USB 2.0 header is available to support 2 additional USB 2.0 ports.

**Infrared Module Header**  
(5-pin IR1)  
(see p.9 No. 25)

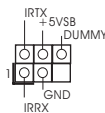

This header supports an optional wireless transmitting and receiving infrared module.

**Internal Audio Connectors**  
(4-pin CD1)  
(CD1: see p.9 No. 33)



CD1

This connector allows you to receive stereo audio input from sound sources such as a CD-ROM, DVD-ROM, TV tuner card, or MPEG card.

---

### Front Panel Audio Header

(9-pin AUDIO1)  
(see p.9 No. 27)

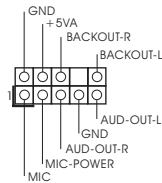

This is an interface for front panel audio cable that allows convenient connection and control of audio devices.

---

### System Panel Header

(9-pin PANEL1)  
(see p.9 No. 18)

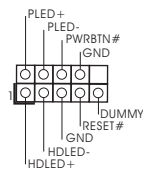

This header accommodates several system front panel functions.

---

### Chassis Speaker Header

(4-pin SPEAKER 1)  
(see p.9 No. 19)

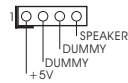

Please connect the chassis speaker to this header.

---

### Chassis Fan Connector

(3-pin CHA\_FAN1)  
(see p.9 No. 17)

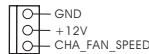

Please connect a chassis fan cable to this connector and match the black wire to the ground pin.

---

### CPU Fan Connector

(3-pin CPU\_FAN1)  
(see p.9 No. 5)

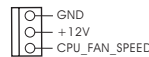

Please connect a CPU fan cable to this connector and match the black wire to the ground pin.

---

### ATX Power Connector

(20-pin ATXPWR1)  
(see p.9 No. 34)



Please connect an ATX power supply to this connector.

---

### ATX 12V Connector

(4-pin ATX12V1)  
(see p.9 No. 2)



Please connect an ATX 12V power supply to this connector.

---

### Game Port Header

(15-pin GAME1)  
(see p.9 No. 24)

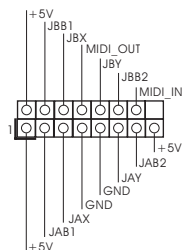

Connect a Game cable to this header if the Game port bracket is installed.

---

## 2.7 Installing VGA\_HDTV Panel to Enjoy HDTV (High-Definition TV) / TV Support Function

Additional VGA\_HDTV panel with VGA and 3 RCA-type component video output, that allows PC to connect to all high-definition TV with component video input capability (YPbPr) or TV with AV input capability.

### ASRock VGA\_HDTV Layout

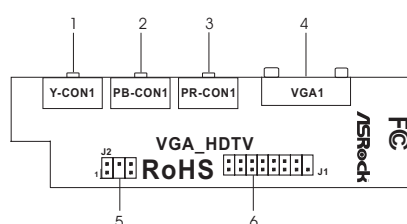

- 1 Y-CON1: RCA-type component video connector (green)
- 2 PB-CON1: RCA-type component video connector (blue) / AV (composite) signal connector
- 3 PR-CON1: RCA-type component video connector (red)
- 4 VGA1: 25pin D-Sub (blue) for VGA monitor
- 5 J2 header
- 6 J1 header

### Installing VGA\_HDTV Panel

- Step 1. Either end of the VGA\_2X8 cable can be connected to the J1 jumper of VGA\_HDTV panel or the VGA1 header of this motherboard.
- Step 2. Either end of the AV/S\_2X3 cable can be connected to the J2 jumper of VGA\_HDTV panel or the TV-OUT header of this motherboard.
- Step 3. Connect the output connectors to all high-definition TV with component video input capability (YPbPr) or TV with AV input capability.
- Step 4. Secure the VGA\_HDTV panel with the bracket to the chassis.



1. You must have a monitor attached to your computer to install the VGA driver correctly in advance.
2. After installing the VGA driver to the computer, this motherboard supports static "Auto Sensing" feature. That is, if you install the stand alone HDTV, TV, or VGA monitor before your computer boots, the system can display correctly on the output device you use. Therefore, if you only install HDTV or TV instead of VGA monitor, it is not necessary for you to enable the TV display setting in Windows control panel or change BIOS setup, and you can enjoy the HDTV or TV display function directly.

---

### 2.7.1 HDTV (High-Definition TV) Support Function

View computer output directly on your High Definition Television (HDTV) or other devices with component video input capability. Provide a big-screen experience for your computer that is ideal for playing games, giving presentations, watching movies, and browsing the Internet.

HDTV uses YPbPr connectors to receive input. The HDTV Component Video Adapter can be used in place of the standard AV Output cable to connect to an HDTV or other component video input devices, using component video cables.

#### Connecting to HDTV With Component Video (YPbPr) Output Capability

Step 1. Connect the Male/Male RCA patch cables to the Typical HDTV component Video Input connectors and the RCA-type component video connectors (Y-CON1, PB-CON1, and PR-CON1) (Y-CON1, see page 19, No. 1; PB-CON1, see page 19, No. 2; PR-CON1, see page 19, No. 3) of the VGA\_HDTV panel.

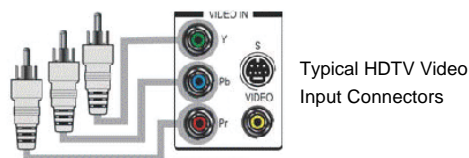

Male/Male RCA Patch Cables -  
available from consumer  
electronics dealer



Please correctly connect the Male/Male RCA patch cables to both HDTV Video Input connectors and RCA-type component video connectors according to the functions of the connectors distinguished by the same color (green, blue, and red). For example, you need to connect the red Male/Male RCA patch cable to the red port (PR) of HDTV and the red port (PR-CON1) of VGA\_HDTV panel. Please see your HDTV and Male/Male RCA patch cables manuals for configuration information specific to your device.

Step 2. Turn on your computer and wait system to boot into OS.

Step 3. Change HDTV display settings.



For maximum performance when you watch DVD movies or play computer games on your HDTV, you should find the mode and screen resolution that provide the best result on your TV, and use those settings exclusively.

- 
- A. Click the Windows **Start** button, point at **Settings**, and then click **Control Panel**.
  - B. Double-click the **Display** icon, click the **Settings** tab, and use the Screen Area slider to select the resolution you want.



If the resolution you select is not related to a specific timing, the system will reduce the resolution to the closest supported timing.

- C. Click the **Advanced** button, then click the **Displays** tab.
- D. Click the **YPbPr** tab.
- E. Click **OK**.
- F. Click the **Advanced** button.
- G. Click the **Adapter** tab, then click the **List All Modes** button.
- H. You can only choose 480i and 480p modes (640 x 480; 704 x 480; 720 x 480), 720p modes (960 x 720; 1280 x 720), or 1080i modes (1920 x 1080). Click the mode according to your HDTV screen.
  - 60Hz = Progressive
  - 30Hz = Interlaced



In DOS mode, only 480p is supported for HDTV output.

## Connecting to VGA Monitor and HDTV With Component Video (YPbPr) Output Capability

When you install both VGA monitor cable and Male/Male RCA patch cables to VGA\_HDTV panel at the same time, the default enabled screen is the VGA monitor. You are able to switch the monitor display to HDTV display by following the below instruction.

- Step 1. Connect one end of the VGA monitor cable to your monitor, and the other end to the VGA port (VGA1, see page 19, No. 4) of VGA\_HDTV panel.
- Step 2. Connect the Male/Male RCA patch cables to the Typical HDTV component Video Input connectors and the RCA-type component video connectors (Y-CON1, PB-CON1, and PR-CON1) (Y-CON1, see page 19, No. 1; PB-CON1, see page 19, No. 2; PR-CON1, see page 19, No. 3) of the VGA\_HDTV panel.
- Step 3. Turn on your computer and wait system to boot into OS.
- Step 4. Enable the TV display. Please follow the below steps:
  - A. Access the Windows **Control Panel**. Double-click **Display**.
  - B. Click the **Settings** tab and then the **Advanced** button.
  - C. Click the **ATI Displays** tab. Click the **TV** button.

- 
- D. Click the enable button or disable button accordingly for YPbPr display output.



Enable Button (Green)



Disable Button (Red)

- E. Click **OK** or **Apply** to save the changes or use hot key to do fast switching between CRT and YPbPr. (Default hot key is **Alt-F5**.)
- F. Your HDTV will start to display.
- Step 5. Change HDTV display settings. (Please refer to Step 3 on page 20 for details.)

## 2.7.2 TV Support Function

### Connecting to TV With AV Output Capability

- Step 1. Connect the AV video cable to the Typical TV Video Input connector (yellow) and the RCA-type component video connector (blue) / AV (composite) signal connector (PB-CON1, see page 19, No. 2) of the VGA\_HDTV panel.
- Step 2. Turn on your computer and wait system to boot into OS.

### Connecting to VGA Monitor and TV With AV Output Capability

When you install both VGA monitor cable and AV video cable to VGA\_HDTV panel at the same time, the default enabled screen is the VGA monitor. You are able to switch the monitor display to TV display by following the below instruction.

- Step 1. Connect one end of the VGA monitor cable to your monitor, and the other end to the VGA port (VGA1, see page 19, No. 4) of VGA\_HDTV panel.
- Step 2. Connect the AV video cable to the Typical TV Video Input connector (yellow) and the RCA-type component video connector (blue) / AV (composite) signal connector (PB-CON1, see page 19, No. 2) of the VGA\_HDTV panel.
- Step 3. Turn on your computer and wait system to boot into OS.
- Step 4. Switch the monitor display to TV display and select proper TV format. For selecting proper TV format, please follow the below steps:
- Click the Windows **Start** button, point at **Settings**, and then click **Control Panel**.
  - Double-click the **Display** icon, click the **Settings** tab, and use the Screen Area slider to select the resolution you want.
  - Click the **Advanced** button, then click the **Displays** tab.
  - Click the **TV** tab, and select **NTSC, PAL**.
  - Your TV will start to display.

---

## 2.8 Untied Overclocking Technology

This motherboard supports Untied Overclocking Technology, which means during overclocking, FSB enjoys better margin due to fixed PCI / PCIE buses. Before you enable Untied Overclocking function, please enter "Overclock Mode" option of BIOS setup to set the selection from [Auto] to [CPU, PCIE, Async.]. Therefore, CPU FSB is untied during overclocking, but PCI and PCIE buses are in the fixed mode so that FSB can operate under a more stable overclocking environment.

## 2.9 Serial ATA (SATA) Hard Disks Installation

This motherboard adopts Uli M1573 southbridge chipset that supports Serial ATA (SATA) hard disks and RAID functions (RAID 0, 1, JBOD). You may install SATA hard disks on this motherboard for internal storage devices. This section will guide you to install the SATA hard disks.

- STEP 1: Install the SATA hard disks into the drive bays of your chassis.
- STEP 2: Connect the SATA power cable to the SATA hard disk.
- STEP 3: Connect one end of the SATA data cable to the motherboard's SATA connector.
- STEP 4: Connect the other end of the SATA data cable to the SATA hard disk.



If you plan to use RAID 0, RAID 1, or JBOD functions on SATA, SATA HDDs must not operate in ATA Combination Mode enabled. Please refer to page 32 for details.

---

## 2.10 Making a SATA Driver Diskette For Windows 2000 /XP / XP 64-bit Installation

If you want to install Windows 2000, Windows XP, or Windows XP 64-bit OS on your SATA HDDs, you will need to make a SATA driver before you start the OS installation.

STEP 1: Insert the ASRock Support CD into your optical drive to boot your system. (Do NOT insert any floppy diskette into the floppy drive at this moment!)

STEP 2: During POST at the beginning of system boot-up, press <F11> key, and then a window for boot devices selection appears. Please select CD-ROM as the boot device.

STEP 3: When you see the message on the screen, "Do you want to generate Serial ATA driver diskette [YN]?", press <Y>.

STEP 4: Then you will see these messages,

**Please insert a diskette into the floppy drive.**

**WARNING! Formatting the floppy diskette will lose ALL data in it!**

**Start to format and copy files [YN]?**

Please insert a floppy diskette into the floppy drive, and press <Y>.

STEP 5: The system will start to format the floppy diskette and copy SATA drivers into the floppy diskette.

Once you have the SATA driver diskette ready, you may start to install Windows 2000 / Windows XP / Windows XP 64-bit on your system directly without setting the RAID configuration on your system, or you may start to use "RAID Installation Guide" to set RAID 0 / RAID 1 / JBOD configuration before you install the OS. Before you start to configure the RAID function, you need to check the installation guide in the Support CD for proper configuration. Please find the document, "Guide to SATA Hard Disks Installation and RAID Configuration", at the following path in the Support CD:

**.. \ Information \ Manual \ RAID Installation Guide \ English.pdf**



---

## Chapter 3 BIOS SETUP UTILITY

### 3.1 Introduction

This section explains how to use the BIOS SETUP UTILITY to configure your system. The BIOS FWH chip on the motherboard stores the BIOS SETUP UTILITY. You may run the BIOS SETUP UTILITY when you start up the computer. Please press <F2> during the Power-On-Self-Test (POST) to enter the BIOS SETUP UTILITY, otherwise, POST will continue with its test routines.

If you wish to enter the BIOS SETUP UTILITY after POST, restart the system by pressing <Ctl> + <Alt> + <Delete>, or by pressing the reset button on the system chassis. You may also restart by turning the system off and then back on.



Because the BIOS software is constantly being updated, the following BIOS setup screens and descriptions are for reference purpose only, and they may not exactly match what you see on your screen.

#### 3.1.1 BIOS Menu Bar

The top of the screen has a menu bar with the following selections:

- Main** To set up the system time/date information
- Advanced** To set up the advanced BIOS features
- H/W Monitor** To display current hardware status
- Boot** To set up the default system device to locate and load the Operating System
- Security** To set up the security features
- Exit** To exit the current screen or the BIOS SETUP UTILITY

Use <←> key or <→> key to choose among the selections on the menu bar, and then press <Enter> to get into the sub screen.

### 3.1.2 Navigation Keys

Please check the following table for the function description of each navigation key.

Navigation Key(s)	Function Description
← / →	Moves cursor left or right to select Screens
↑ / ↓	Moves cursor up or down to select items
+ / -	To change option for the selected items
<Enter>	To bring up the selected screen
<F1>	To display the General Help Screen
<F9>	To load optimal default values for all the settings
<F10>	To save changes and exit the BIOS SETUP UTILITY
<ESC>	To jump to the Exit Screen or exit the current screen

### 3.2 Main Screen

When you enter the BIOS SETUP UTILITY, the Main screen will appear and display the system overview

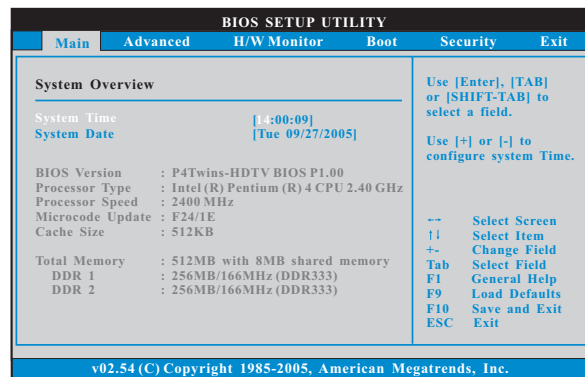

#### System Time [Hour:Minute:Second]

Use this item to specify the system time.

#### System Date [Day Month/Date/Year]

Use this item to specify the system date.

### 3.3 Advanced Screen

In this section, you may set the configurations for the following items: CPU Configuration, Chipset Configuration, ACPI Configuration, IDE Configuration, PCI/PnP Configuration, Floppy Configuration, SuperIO Configuration, and USB Configuration.

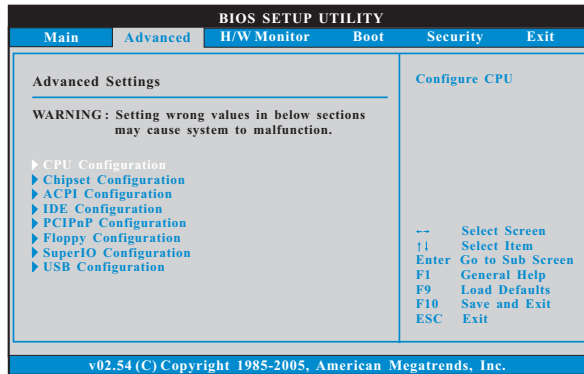

Setting wrong values in this section may cause the system to malfunction.

#### 3.3.1 CPU Configuration

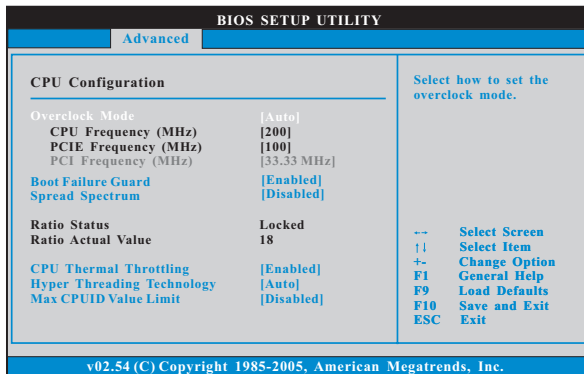

##### Overclock Mode

Use this to select Overclock Mode. The default value is [Auto]. Configuration options: [Auto], [CPU, PCIE, Sync.] and [CPU, PCIE, Async.]. If Overclock Mode is set to [Auto], you are not allowed to select PCI Frequency; if you select [CPU, PCIE, Sync.] or [CPU, PCIE, Async.], then PCI Frequency can be selected as [sync with CPU], [33.33 MHz], [33.80 MHz], [34.28 MHz], [34.78 MHz], [35.29 MHz], [35.82 MHz], [36.36 MHz], [36.92 MHz], or [37.50 MHz]. The default value of PCI Frequency is [33.33 MHz].

##### Boot Failure Guard

Enable or disable the feature of Boot Failure Guard.

---

### Spread Spectrum

The default value of this option is [Auto].

### Ratio Status

This is a read-only item, which displays whether the ratio status of this motherboard is “Locked” or “Unlocked”. If it shows “Unlocked”, you will find an item **Ratio CMOS Setting** appears to allow you changing the ratio value of this motherboard. If it shows “Locked”, then the item **Ratio CMOS Setting** will be hidden. If you use the ratio value to time the CPU frequency, it will be equal to the core speed of the installed processor.

### Ratio Actual Value

This is a read-only item, which displays the ratio actual value of this motherboard.

### CPU Thermal Throttling

You may select [Enabled] to enable P4 CPU internal thermal control mechanism to keep the CPU from overheated.

### Hyper Threading Technology

To enable this feature, it requires a computer system with an Intel Pentium®4 processor that supports Hyper-Threading technology and an operating system that includes optimization for this technology, such as Microsoft® Windows® XP. Set to [Auto] if using Microsoft® Windows® XP, or Linux kernel version 2.4.18 or higher. This option will be hidden if the installed CPU does not support Hyper-Threading technology.

### Max CPUID Value Limit

For Prescott CPU only, some OSes (ex. NT4.0) cannot handle the function with disable. This should be enabled in order to boot legacy OSes that cannot support CPUs with extended CPUID functions.

## 3.3.2 Chipset Configuration

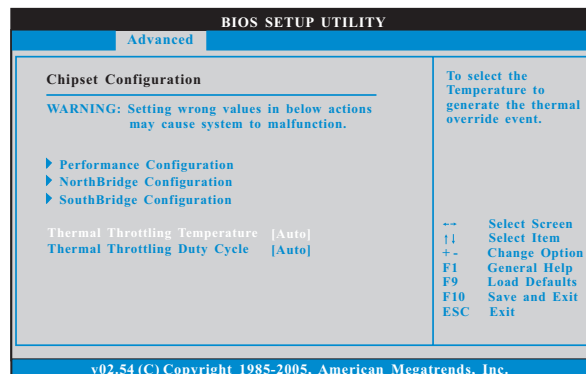

---

## Performance Configuration

### DRAM Frequency

If [Auto] is selected, the motherboard will detect the memory module (s) inserted and assigns appropriate frequency automatically. You may also select other value as operating frequency: [Auto], [Sync with CPU], [133MHz (DDR 266)], [166MHz (DDR 333)], [200MHz (DDR 400)]. If DDRII DIMM is inserted to DDRII slot, you may select [Auto], [Sync with CPU], [200MHz (DDRII 400)], [266MHz (DDRII 533)], [333MHz (DDRII 667)] as operating frequency.

### Overclock DRAM Speed

Use this to select overclock DRAM speed. The default value is [None].

### Flexibility Option

The default value of this option is [Disabled]. It will allow better tolerance for memory compatibility when it is set to [Enabled].

### CAS Latency (CL)

Use this item to adjust the latency time for memory accessing. Configuration options for DDR: [Auto], [2.0], [3.0], and [2.5]. Configuration options for DDRII: [Auto], [3.0], [4.0], and [5.0]. The default value is [Auto].

### Cycle time (TRAS)

Use this to adjust TRAS values. Configuration options for DDR: [Auto], [2CLK] to [8CLK]. configuration options for DDRII: [Auto], [2CLK] to [128CLK]. The default value is [Auto].

### RAS# to CAS# Delay (TRCD)

This controls the latency between the DRAM active command and the read / write command. Configuration options for DDR: [Auto], [2 DRAM Clocks] to [4 DRAM Clocks]. Configuration options for DDRII: [Auto], [2 DRAM Clocks] to [15 DRAM Clocks]. The default value is [Auto].

### RAS# Precharge Time (TRP)

Use this to adjust TRP values. Configuration options for DDR: [Auto], [1CLK], [2CLK], [3CLK]. Configuration options for DDRII: [Auto], [1CLK] to [15CLK]. The default value is [Auto].

### MA Timing

Use this to adjust values for MA timing. Configuration options: [Auto], [2T], [1T], [1.5T]. The default value is [Auto].

### Write to Write Turn Around

Configuration options for DDR: [Auto], [0CLK] to [3CLK]. Configuration options for DDRII: [Auto], [0CLK] to [7CLK]. The default value is [Auto].

### Read to Write Turn Around

Configuration options for DDR: [Auto], [0CLK] to [3CLK]. Configuration options for DDRII: [Auto], [0CLK] to [7CLK]. The default value is [Auto].

---

**Write to Read Turn Around**

Configuration options for DDR: [Auto], [0CLK] to [3CLK]. Configuration options for DDRII: [Auto], [0CLK] to [7CLK]. The default value is [Auto].

**DRAM Voltage**

Use this to select DRAM voltage. Configuration options: [Auto], [High], [Normal], and [Low]. The default value is [Auto].

**NorthBridge Configuration****Share Memory**

This allows you to set share memory feature. The default value is [Auto]. Configuration options: [Auto], [16MB], [32MB], [64MB], and [128MB].

**Primary Graphics Adapter**

This item will switch the PCI Bus scanning order while searching for video card. It allows you to select the type of Primary VGA in case of multiple video controllers. The default value of this feature is [PCI]. Configuration options: [Onboard], [PCI] and [PCI Express].

**Surround View Function**

This allows you to disable or enable surround view function. The default value is [Disabled].

**Video Display Devices**

This allows you to select video display devices. The default value is [Auto]. Configuration options: [CRT], and [TV].

**TV Standard**

This allows you to set TV standard feature. The default value is [NTSC]. Configuration options: [NTSC], [PAL], [PAL-M], [PAL-60], [NTSC-JAP], [PAL-CN], [PAL-N].

**SouthBridge Configuration****OnBoard LAN**

This allows you to enable or disable the "OnBoard LAN" feature.

**OnBoard AC'97 Audio**

Select [Auto], [Enabled] or [Disabled] for the onboard AC'97 Audio feature.

**OnBoard MC'97 Modem**

Select [Auto] or [Disabled] for the onboard MC'97 Modem feature.

**Thermal Throttling Temperature**

To select the temperature to generate the thermal override event. Configuration options: [Auto], [Disabled], [30° C], [35° C], [40° C], [45° C], [50° C], [55° C], [60° C], [65° C], [70° C], [75° C]. If you select [Disabled], you will not find Thermal Throttling Duty Cycle option appear. The default value is [Auto].

**Thermal Throttling Duty Cycle**

To select duty cycle of the STPCLK# signal when the thermal override event is generated. Configuration options: [Auto], [12.5%], [25.00%], [37.50%], [50.00%], [62.50%], [75.00%], [87.50%]. The default value is [Auto].

---

### 3.3.3 ACPI Configuration

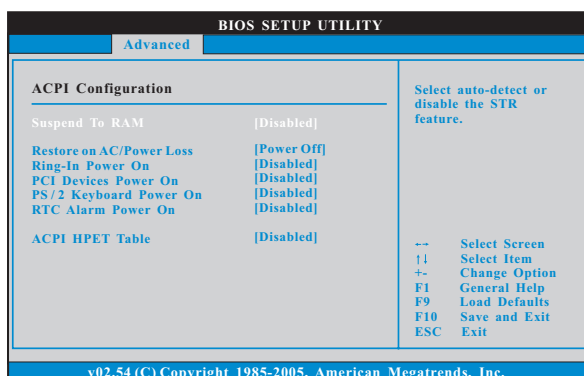

#### Suspend to RAM

This field allows you to select whether to auto-detect or disable the Suspend-to-RAM feature. Select [Auto] will enable this feature if the system supports it. The default value is [Disabled].

#### Restore on AC/Power Loss

This allows you to set the power state after an unexpected AC/Power loss. If [Power Off] is selected, the AC/Power remains off when the power recovers. If [Power On] is selected, the AC/Power resumes and the system starts to boot up when the power recovers.

#### Ring-In Power On

Use this item to enable or disable Ring-In signals to turn on the system from the power-soft-off mode.

#### PCI Devices Power On

Use this item to enable or disable PCI devices to turn on the system from the power-soft-off mode.

#### PS/2 Keyboard Power On

Use this item to enable or disable PS/2 keyboard to turn on the system from the power-soft-off mode.

#### RTC Alarm Power On

Use this item to enable or disable RTC (Real Time Clock) to power on the system.

#### ACPI HPET Table

Use this item to enable or disable ACPI HPET table feature. It will include ACPI High Precision Event Timer Table for OS if you set this option to [Enabled].

---

### 3.3.4 IDE Configuration

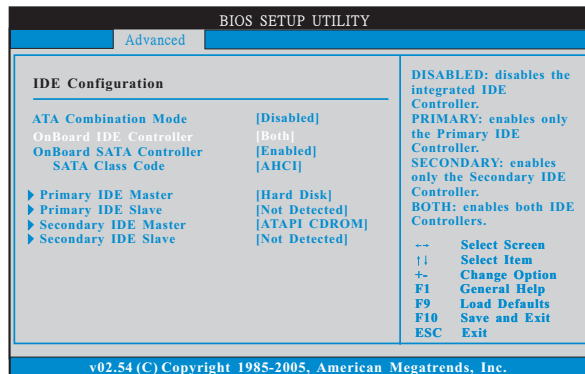

#### ATA Combination Mode

The default value is [Disabled]. If you set this option as [Enabled], the options OnBoard IDE Controller, OnBoard SATA Controller, and SATA Class Code will not appear. Then, PATA devices will only connect to secondary channel, SATA devices will only connect to SATA1 and it will work as primary channel.

#### OnBoard IDE Controller

You may enable either the primary IDE channel or the secondary IDE channel. Or you may enable both the primary and the secondary IDE channels by selecting [Both]. Set to [Disabled] will disable the both. Configuration options: [Disabled], [Primary], [Secondary], [Both].

#### OnBoard SATA Controller

Use this item to enable or disable the "OnBoard SATA Controller" feature. The default value is [Enabled].

#### SATA Class Code

Use this to program SATA controller's class code. Configuration options: [AHCI], [RAID]. The default value is [AHCI].



---

### IDE Device Configuration

You may set the IDE configuration for the device that you specify. We will use the “Primary IDE Master” as the example in the following instruction, which can be applied to the configurations of “Primary IDE Slave”, “Secondary IDE Master”, and “Secondary IDE Slave” as well.

### IDE Device Configuration

You may set the IDE configuration for the device that you specify. We will use the “Primary IDE Master” as the example in the following instruction.

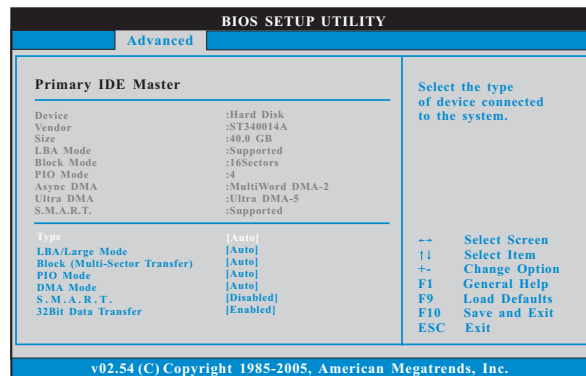

### TYPE

Use this item to configure the type of the IDE device that you specify. Configuration options: [Not Installed], [Auto], [CD/DVD], and [ARMD].

**[Not Installed]:** Select [Not Installed] to disable the use of IDE device.

**[Auto]:** Select [Auto] to automatically detect the hard disk drive.



After selecting the hard disk information into BIOS, use a disk utility, such as FDISK, to partition and format the new IDE hard disk drives. This is necessary so that you can write or read data from the hard disk. Make sure to set the partition of the Primary IDE hard disk drives to active.

**[CD/DVD]:** This is used for IDE CD/DVD drives.

**[ARMD]:** This is used for IDE ARMD (ATAPI Removable Media Device), such as MO.

### LBA/Large Mode

Use this item to select the LBA/Large mode for a hard disk > 512 MB under DOS and Windows; for Netware and UNIX user, select [Disabled] to disable the LBA/Large mode.

---

### Block (Multi-Sector Transfer)

The default value of this item is [Auto]. If this feature is enabled, it will enhance hard disk performance by reading or writing more data during each transfer.

### PIO Mode

Use this item to set the PIO mode to enhance hard disk performance by optimizing the hard disk timing.

### DMA Mode

DMA capability allows the improved transfer-speed and data-integrity for compatible IDE devices.

### S.M.A.R.T.

Use this item to enable or disable the S.M.A.R.T. (Self-Monitoring, Analysis, and Reporting Technology) feature. Configuration options: [Disabled], [Auto], [Enabled].

### 32-Bit Data Transfer

Use this item to enable 32-bit access to maximize the IDE hard disk data transfer rate.

## 3.3.5 PCIPnP Configuration

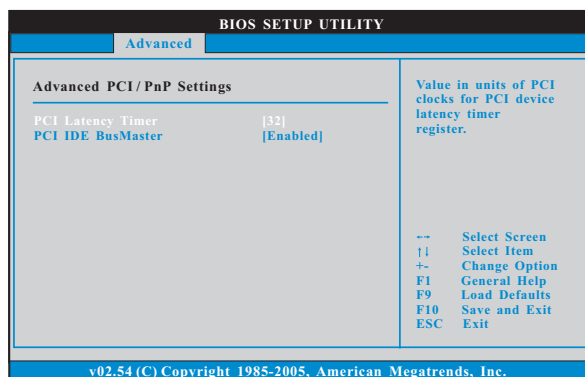

### PCI Latency Timer

The default value is 32. It is recommended to keep the default value unless the installed PCI expansion cards' specifications require other settings.

### PCI IDE BusMaster

Use this item to enable or disable the PCI IDE BusMaster feature.

---

### 3.3.6 Floppy Configuration

In this section, you may configure the type of your floppy drive.

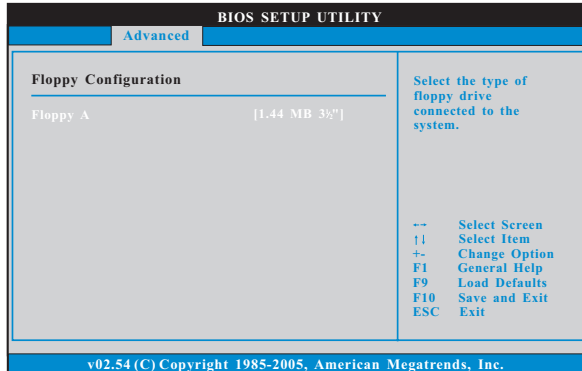

### 3.3.7 Super IO Configuration

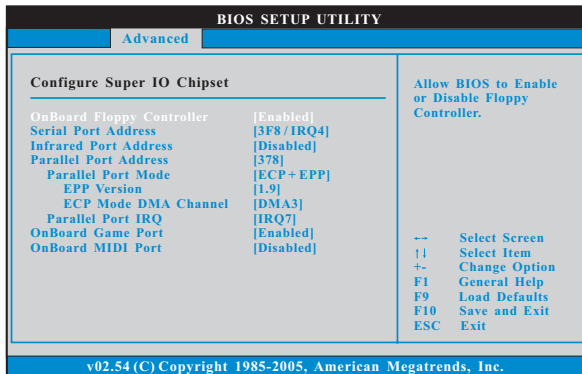

#### OnBoard Floppy Controller

Use this item to enable or disable floppy drive controller.

#### Serial Port Address

Use this item to set the address for the onboard serial port or disable it.

Configuration options: [Disabled], [3F8 / IRQ4], [2F8 / IRQ3], [3E8 / IRQ4], [2E8 / IRQ3].

#### Infrared Port Address

Use this item to set the address for the onboard infrared port or disable it.

Configuration options: [Disabled], [2F8 / IRQ3], and [2E8 / IRQ3].

---

**Parallel Port Address**

Use this item to set the address for the onboard parallel port or disable it. Configuration options: [Disabled], [378], and [278].

**Parallel Port Mode**

Use this item to set the operation mode of the parallel port. The default value is [ECP+EPP]. If this option is set to [ECP+EPP], it will show the EPP version in the following item, "EPP Version". Configuration options: [Normal], [Bi-Directional], and [ECP+EPP].

**EPP Version**

Use this item to set the EPP version. Configuration options: [1.9] and [1.7].

**ECP Mode DMA Channel**

Use this item to set the ECP mode DMA channel. Configuration options: [DMA0], [DMA1], and [DMA3].

**Parallel Port IRQ**

Use this item to set the IRQ for the parallel port. Configuration options: [IRQ5] and [IRQ7].

**OnBoard Game Port**

Use this item to enable the Game Port or disable it.

**OnBoard MIDI Port**

Use this item to select the address for the MIDI Port or disable it. Configuration options: [Disabled], [300], and [330].

### 3.3.8 USB Configuration

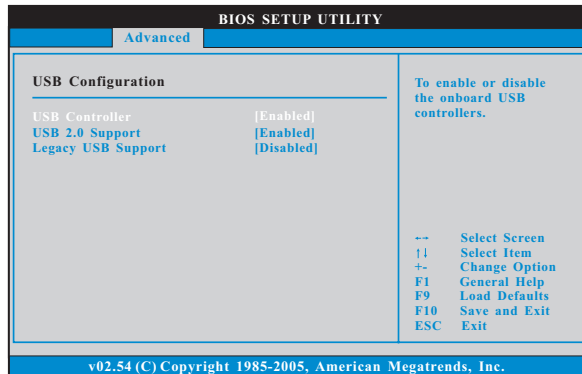

#### USB Controller

Use this item to enable or disable the use of USB controller.

#### USB 2.0 Support

Use this item to enable or disable the USB 2.0 support.

#### Legacy USB Support

Use this item to enable or disable the support to emulate legacy I/O devices such as mouse, keyboard,... etc. Or you may select [Auto] so that the system will start to auto-detect; if there is no USB device connected, "Auto" option will disable the legacy USB support.

### 3.4 Hardware Health Event Monitoring Screen

In this section, it allows you to monitor the status of the hardware on your system, including the parameters of the CPU temperature, motherboard temperature, CPU fan speed, chassis fan speed, and the critical voltage.

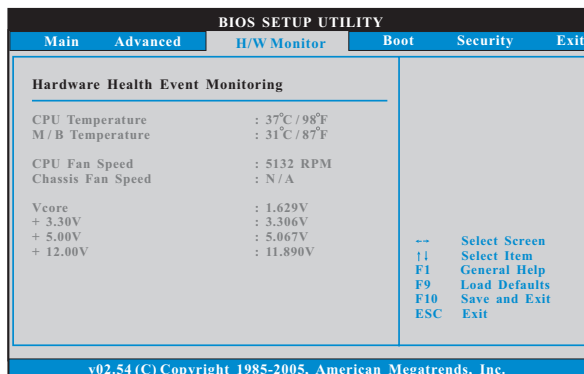

---

### 3.5 Boot Screen

In this section, it will display the available devices on your system for you to configure the boot settings and the boot priority.

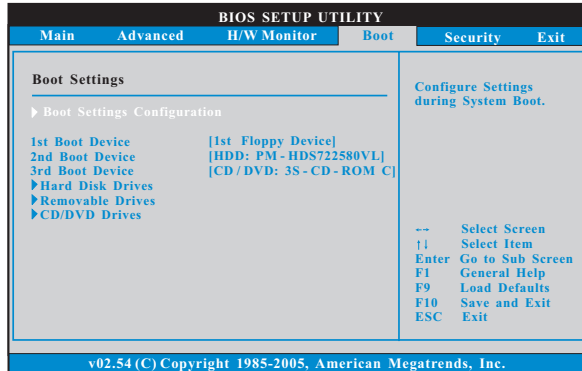

#### 3.5.1 Boot Settings Configuration

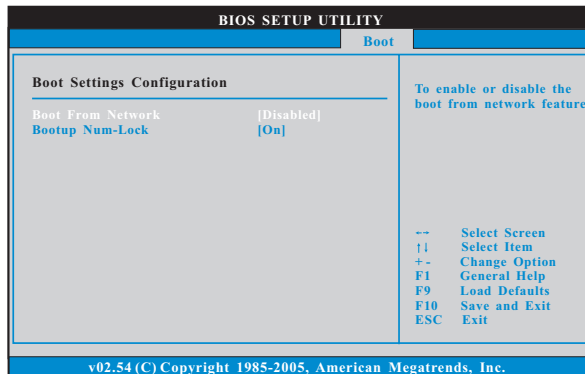

##### Boot From Network

Use this item to enable or disable the Boot From Network feature.

##### Boot Up Num-Lock

If this item is set to [On], it will automatically activate the Numeric Lock function after boot-up.

---

### 3.6 Security Screen

In this section, you may set or change the supervisor/user password for the system. For the user password, you may also clear it.

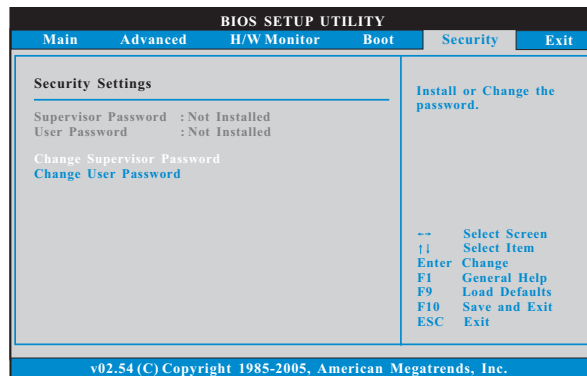

---

### 3.7 Exit Screen

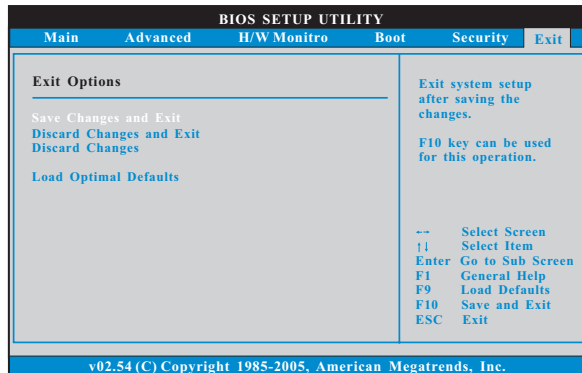

#### Save Changes and Exit

When you select this option, it will pop-out the following message, "Save configuration changes and exit setup?" Select [OK] to save the changes and exit the BIOS SETUP UTILITY.

#### Discard Changes and Exit

When you select this option, it will pop-out the following message, "Discard changes and exit setup?" Select [OK] to exit the BIOS SETUP UTILITY without saving any changes.

#### Discard Changes

When you select this option, it will pop-out the following message, "Discard changes?" Select [OK] to discard all changes.

#### Load Optimal Defaults

When you select this option, it will pop-out the following message, "Load optimal defaults?" Select [OK] to load the default values for all the setup configurations.



---

## **Chapter 4 Software Support**

### **4.1 Install Operating System**

This motherboard supports various Microsoft® Windows® operating systems: 2000 / XP / XP 64-bit. Because motherboard settings and hardware options vary, use the setup procedures in this chapter for general reference only. Refer to your OS documentation for more information.

### **4.2 Support CD Information**

The Support CD that came with the motherboard contains necessary drivers and useful utilities that enhance the motherboard features.

#### **4.2.1 Running The Support CD**

To begin using the support CD, insert the CD into your CD-ROM drive. The CD automatically displays the Main Menu if "AUTORUN" is enabled in your computer. If the Main Menu did not appear automatically, locate and double click on the file "ASSETUP.EXE" from the BIN folder in the Support CD to display the menus.

#### **4.2.2 Drivers Menu**

The Drivers Menu shows the available devices drivers if the system detects installed devices. Please install the necessary drivers to activate the devices.

#### **4.2.3 Utilities Menu**

The Utilities Menu shows the applications software that the motherboard supports. Click on a specific item then follow the installation wizard to install it.

#### **4.2.4 Contact Information**

If you need to contact ASRock or want to know more about ASRock, welcome to visit ASRock's website at <http://www.asrock.com>; or you may contact your dealer for further information.