

P4TSE-D2

FCC Information and Copyright

This equipment has been tested and found to comply with the limits of a Class B digital device, pursuant to Part 15 of the FCC Rules. These limits are designed to provide reasonable protection against harmful interference in a residential installation. This equipment generates, uses and can radiate radio frequency energy and, if not installed and used in accordance with the instructions, may cause harmful interference to radio communications. There is no guarantee that interference will not occur in a particular installation.

The vendor makes no representations or warranties with respect to the contents here of and specially disclaims any implied warranties of merchantability or fitness for any purpose. Further the vendor reserves the right to revise this publication and to make changes to the contents here of without obligation to notify any party beforehand. Duplication of this publication, in part or in whole, is not allowed without first obtaining the vendor's approval in writing.

The content of this user's manual is subject to be changed without notice and we will not be responsible for any mistakes found in this user's manual. All the brand and product names are trademarks of their respective companies.

Content

LAYOUT OF P4TSE-D2 (FOR VERSION 1.X ONLY) 1

LAYOUT OF P4TSE-D2 (FOR VERSION 7.X ONLY) 2

ENGLISH..... 3

 P4TSE-D2 Features.....3

 Package contents.....5

 How to set up Jumper.....5

 CPU Installation.....6

 DDR DIMM Modules: DDRA1, DDRB17

 Installing DDR Module.....7

 Jumpers, Headers, Connectors & Slots.....8

FRANÇAIS 16

 Caractéristiques de P4TSE-D2..... 16

WARPSPEEDER™ 19

 Introduction..... 19

 System Requirement..... 19

 Installation 20

 Usage..... 21

TROUBLE SHOOTING..... 30

DÉPANNAGE..... 31

Layout of P4TSE-D2 (for version 1.x only)

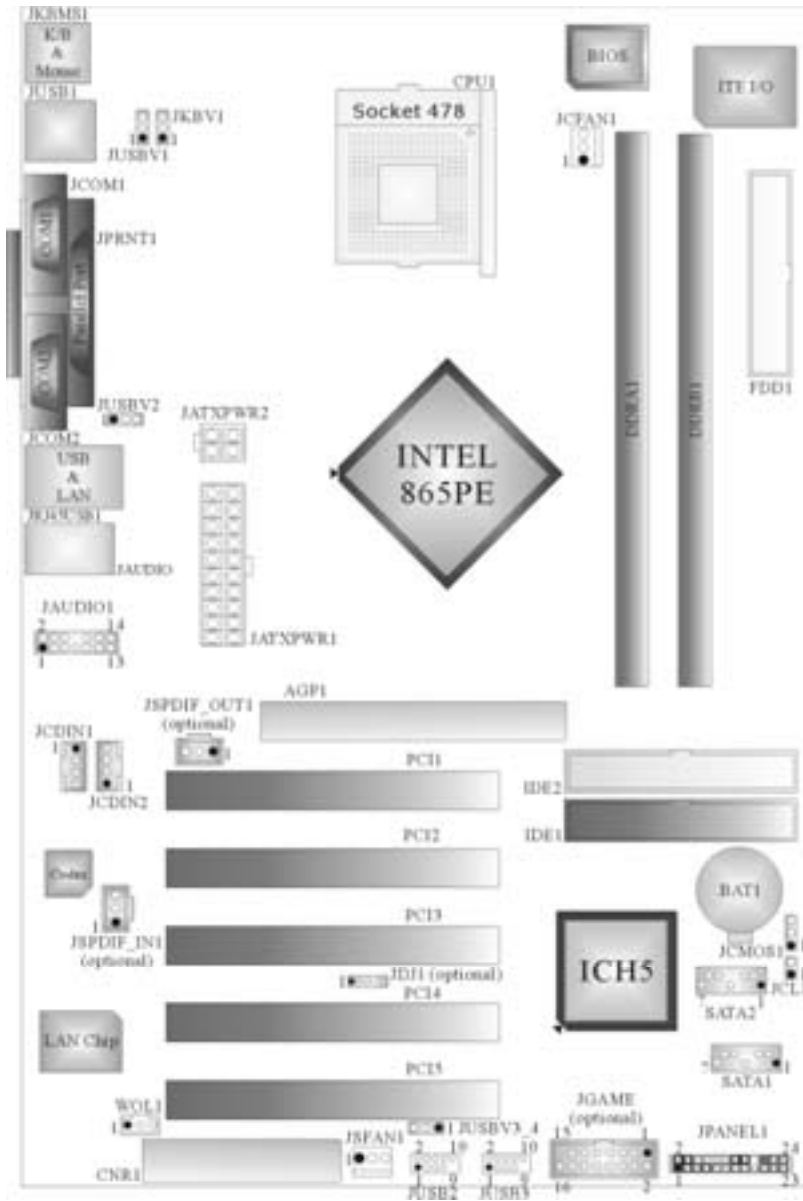

Layout of P4TSE-D2 (for version 7.x only)

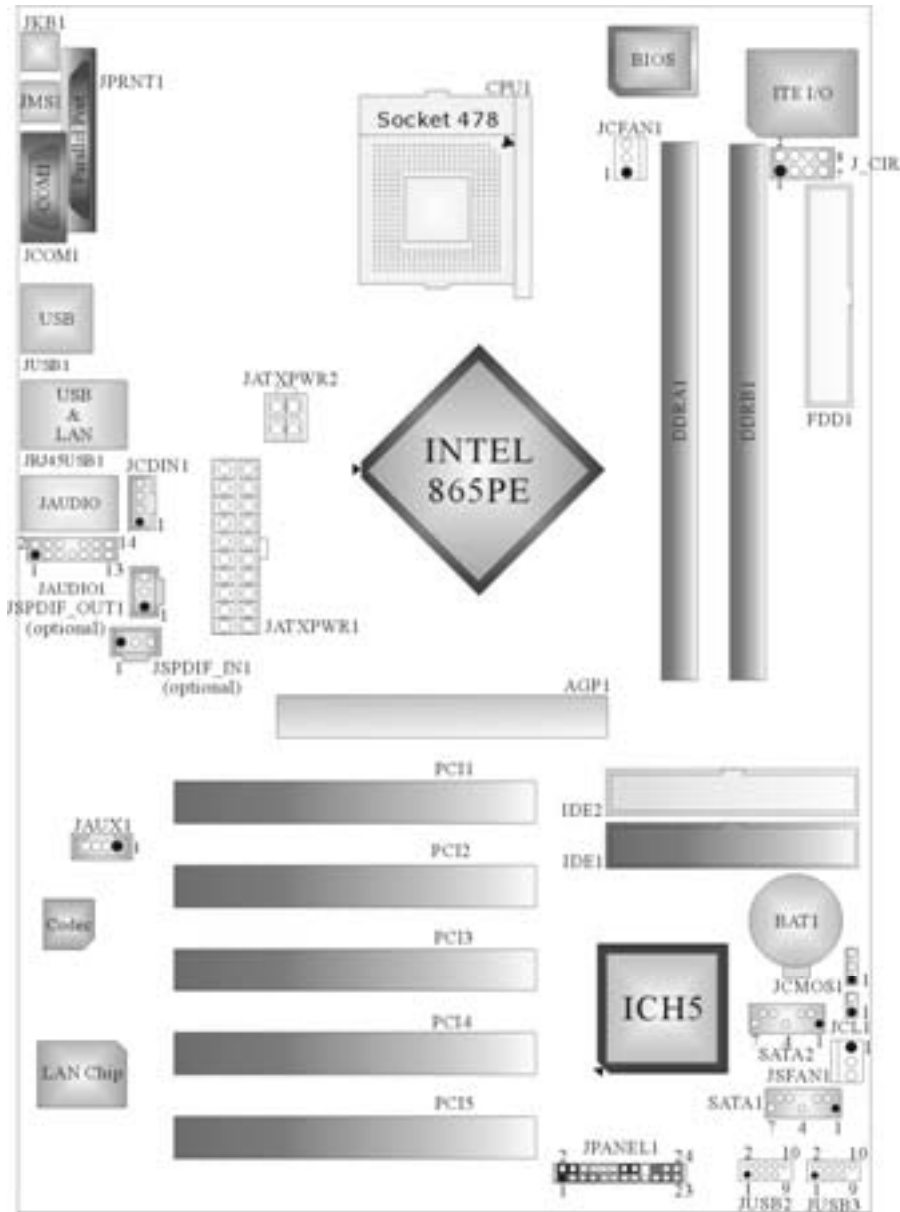

English

P4TSE-D2 Features

A. Hardware

CPU

- Provides Socket-478.
- Supports the Intel® Pentium® 4 processor to 3.2GHz.
- Front Side Bus at 400/533/800 MHz.
- Supports Hyper-Threading Technology.
- Supports Intel® Pentium® 4 Northwood CPU. (Willamette not supported)
- Supports Intel® Pentium® 4 478 Prescott CPU. (for versions above 1.2 only)

Chipset

- North Bridge: Intel 865PE.
- South Bridge: Intel ICH5.

Main Memory

- Supports one or two 64-bit wide DDR data channels with 1 DIMMs per-channel.
- Available bandwidth up to 3.2GB/s (DDR400) for single-channel mode and 6.4GB/s (DDR 400) for dual channel mode.
- Supports 128-Mb, 256-Mb, 512-Mb DDR technologies.
- Supports only x8, x16 DDR devices. (Does not support registered DIMMs and ECC)
- Supports four bank devices.
- Maximum memory size is 2GB.

Super I/O

- Chip: ITE IT8712.
- Low Pin Count Interface.
- Provides the most commonly used legacy Super I/O functionality.
- Environment Control initiatives,
 - H/W Monitor
 - ITE's "Smart Guardian" function

Slots

- Five 32-bit PCI bus master slots.
- One CNR slot. (not available on version 7.x)
- One AGP 4X/ 8X compatible slot.

On Board IDE

- Supports four IDE disk drives.
- Supports PIO Mode 4, and Ultra DMA 33/66/100 Bus Master Mode.

LAN (optional for version 1.x)

- Chip: RTL8100C/ RTL8110S.
- Supports 10 Mb/s and 100 Mb/s auto-negotiation operation. (with LAN chip RTL8100C)
- Supports 10 Mb/s, 100 Mb/s and 1000 Mb/s auto-negotiation. (with LAN chip RTL8110S) (optional)
- Half / Full duplex capability.
- Supports ACPI, PCI power management.

LAN (for version 7.x only)

- Chip: RTL8100C.
- Supports 10 Mb/s and 100 Mb/s auto-negotiation operation.
- Half / Full duplex capability.
- Supports ACPI, PCI power management.

On Board AC'97 Sound Codec (for version 1.0 and 1.1 only)

- Chip: CMI9739A.
- Compliant with AC'97 specification.
- Supports 6 channels.

On Board AC'97 Sound Codec (for version 1.2 and above only)

- Chip: CMI9761A
- Compliant with Intel® AC'97 Rev 2.3 specification.
- Meet with Microsoft® PC2001 requirements.
- Supports 6 channels.
- Supports stereo microphone.
- Advanced power management and power saving capabilities.

On Board Peripherals***a. Rearside***

- 2 serial ports. (version 7.x support 1 serial port only)
- 1 parallel port. (SPP/EPP/ECP mode)
- Audio ports in vertical position.
- 1 LAN jack (optional)
- 1 PS/2 mouse
- 1 PS/2 keyboard.
- 4 USB2.0 ports.

b. FrontSide

- 1 floppy port supports 2 FDDs with 360K, 720K, 1.2M, 1.44M and 2.88Mbytes.
- 4 USB2.0 ports.
- 1 front audio header
- 1 S/PDIF Out header. (optional for both version)
- 1 S/PDIF In header. (optional for both version)
- 1 Audio DJ header. (optional in versions 1.x) (not available on version 7.x)

Dimensions

- ATX Form Factor: 20.3 X 30.5cm (W X L) (for version 1.x)
- ATX Form Factor: 20.4 X 29.5cm (W X L) (for version 7.x)

B. BIOS & Software

BIOS

- Support Award legal BIOS.
- Support APM.
- Support ACPI.
- Support USB Function.

Software

- Supports Warpspeeder™, 9th Touch™, WinFlasher™, BootBlocker™, FLASHER™ and StudioFun!™ (optional).
- Offers the highest performance for Windows 98 SE, Windows 2000, Windows Me, Windows XP, UNIX series, etc.

Package contents

- HDD Cable X 1
- FDD Cable X 1
- User's Manual X 1
- Fully Setup Driver CD X 1
- StudioFun! Application CD X 1 (optional)
- USB 2.0 Cable X1 (optional)
- S/PDIF Out/ In Cable X 1 (optional)
- Rear I/O Panel for ATX Case X 1
- Serial ATA Cable X1 (optional)
- Serial ATA Power Switch Cable X 1 (optional)

How to set up Jumper

The illustration shows to how set up jumper. When the Jumper cap is placed on pins, the jumper is "close". If no jumper cap is placed on the pins, the jumper is "open". The illustration shows a 3-pin jumper whose pin1 and 2 are "close" when jumper cap is placed on these 2 pins.



Jumper open



Jumper close

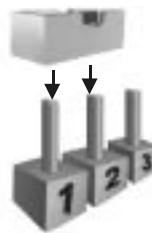

Pin1-2 close

CPU Installation

Step1: Pull the lever sideways away from the socket and then raise the lever up to a 90-degree angle.

Step2: Look for the white dot/cut edge. The white dot/cut edge should point wards the lever pivot. The CPU will fit only in the correct orientation.

Step3: Hold the CPU down firmly, and then close the lever to complete the installation.

Step4: Put the CPU Fan on the CPU and buckle it. Connect the CPU fan power cable to the JCFAN1. This completes the installation.

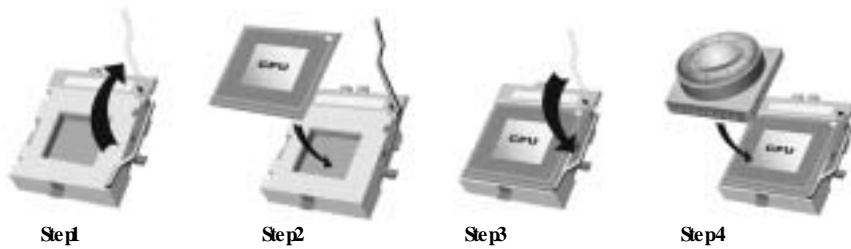

CPU Fan Header: JCFAN1

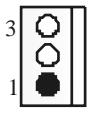
 JCFAN1	Pin	Assignment
	1	Ground
	2	+12V
	3	FAN RPM rate Sense

System Fan Header: JSFAN1

 JSFAN1	Pin	Assignment
	1	Ground
	2	+12V
	3	FAN RPM rate Sense

DDR DIMM Modules: DDRA1, DDRB1

■ *Dual Channel Guidelines*

Matched DIMM configuration in each channel

- Same Density (128MB, 256MB, 512MB, 1GB, etc.)
- Same DRAM technology (128M-bit, 256M-bit, or 512M-bit)
- Same DRAM bus width (x8 or x16)
- Both either single-sided or dual-sided

Matched in both Channel A and Channel B memory channels

- Populate symmetrical memory slots

Optimal platform performance with Dual Channel, DDR400, matched DIMMs

- Fully loaded configurations can be single or double sided DIMMs

When not using DDR400, best performance obtained with

- Symmetrical DIMM population and matched double-sided DIMMs

■ *Dual Channel Configuration Table*

- Dual Channel Configuration Table

DIMM Slot	DDRA1	DDR B1	System Density
Fully Loaded Config	128MB -- 1GB	128MB -- 1GB	256MB -- 2GB

DRAM Access Time: 2.5V Unbuffered/ no registered (without ECC) DDR SDRAM
PC2100/ PC2700/ PC3200 Type required.

DRAM Type: 128MB/ 256MB/ 512MB/ 1GB DIMM Module (184 pin)

Installing DDR Module



1. Unlock a DIMM slot by pressing the retaining clips outward. Align a DIMM on the slot such that the notch on the DIMM matches the break on the slot.
2. Insert the DIMM vertically and firmly into the slot until the retaining chip snap back in place and the DIMM is properly seated.

Jumpers, Headers, Connectors & Slots

Floppy Disk Connector: FDD1

The motherboard provides a standard floppy disk connector that supports 360K, 720K, 1.2M, 1.44M and 2.88M floppy disk types. This connector supports the provided floppy drive ribbon cables.

Hard Disk Connectors: IDE1/ IDE2

The motherboard has a 32-bit Enhanced PCI IDE Controller that provides PIO Mode 0 to Mode 4, Bus Master, and Ultra DMA 33/ 66/ 100 functionality. It has two HDD connectors IDE1 (primary) and IDE2 (secondary).

The IDE connectors can connect a master and a slave drive; therefore, you can connect up to four hard disk drives. The first hard drive should always be connected to IDE1.

Peripheral Component Interconnect Slots: PCI 1-5

This motherboard is equipped with 5 standard PCI slots. PCI stands for Peripheral Component Interconnect, and it is a bus standard for expansion cards. This PCI slot is designated as 32 bits.

Accelerated Graphics Port Slot: AGP1

Your monitor will attach directly to that video card. This motherboard supports video cards for PCI slots, but it is also equipped with an Accelerated Graphics Port (AGP). An AGP card will take advantage of AGP technology for improved video efficiency and performance, especially with 3D graphics.

Communication Network Riser Slot: CNR1 (does not provide on version 7.X)

The CNR specification is an open Industry Standard Architecture, and it defines a hardware scalable riser card interface, which supports modem only.

Serial ATA Connector: SATA1/ SATA2

The motherboard has a PCI to SATA Controller with 2 channels SATA interface, it satisfies the SATA 1.0 spec and with transfer rate of 1.5Gb/s.

Pin	Assignment	Pin	Assignment
1	Ground	2	TX+
3	TX-	4	Ground

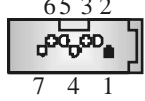
 SATA1/ SATA2	5	RX-	6	RX+
	7	Ground		

Case Open Connector: JCL1

 JCL1	Pin	Assignment
	1	Case Open Signal
	2	Ground

AUDIO DJ Connector: JDJ1 (optional on version 1.x only) (does not support on version 7.x)

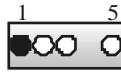
 JDJ1	Pin	Assignment	Pin	Assignment
	1	SMBDATA	2	SMBCLK
	3	INT_B	4	KEY
	5	ATX_PWROK		

Game Header: JGAME (optional on version 1.x) (does not support on version 7.x)

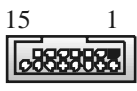
 JGAME			
Pin	Assignment	Pin	Assignment
1	+5V	2	+5V
3	Joy stick B Button 1	4	Joy stick A Button 1
5	Joy stick B Coordinate X	6	Joy stick A Coordinate X
7	MDI Output	8	Ground
9	Joy stick B Coordinate Y	10	Ground
11	Joy stick B Button 2	12	Joy stick A Coordinate Y
13	MDI Input	14	Joy stick A Button 2
15	NA	16	+5V

Front Panel Connector: JPANEL1

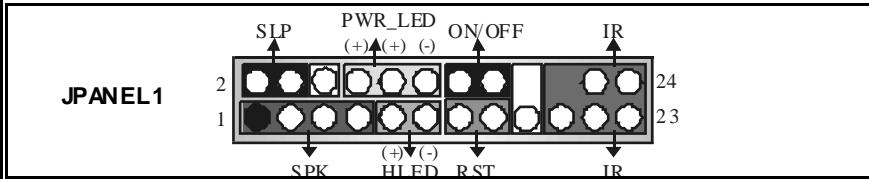

Pin	Assignment	Function	Pin	Assignment	Function
1	+5V	Speaker Connector	2	Sleep Control	Sleep Button
3	NA		4	Ground	
5	NA		6	NA	POWER LED
7	Speaker		8	Power LED (+)	
9	HDD LED (+)	10	Power LED (+)		
11	HDD LED (-)	11	HDD LED (-)	12	Power LED (-)
13	Ground	Reset Button	14	Power Button	Power-on Button
15	Reset Control		16	Ground	
17	NA		18	KEY	
19	NA	IrDA Connector	20	KEY	IrDA Connector
21	+5V		22	Ground	
23	IRTX		24	IRRX	

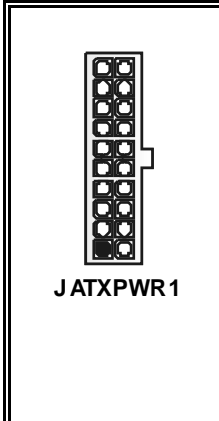

Power Connectors: JATXPWR1/ JATXPWR2



PIN	Assignment	PIN	Assignment
1	+3.3V	11	+3.3V
2	+3.3V	12	-12V
3	Ground	13	Ground
4	+5V	14	PS_ON
5	Ground	15	Ground
6	+5V	16	Ground
7	Ground	17	Ground
8	PW_OK	18	-5V
9	Standby Voltage +5V	19	+5V
10	+12V	20	+5V



 JATXPWR2	PIN	Assignment	PIN	Assignment
	1	+12V	3	Ground
	2	+12V	4	Ground

Power Source Selection for Keyboard/ Mouse: JKBV1 (does not support on version 7.x)

JKBV1	Assignment	Description
 Pin 1-2 close	+5V	+5V for key board and mouse
 Pin 2-3 close	+5V Standby Voltage	PS/2 Mouse and PS/2 Keyboard are powered with +5V standby v oltag e

Note: In order to support the function: "Power-on system via keyboard and mouse", "JKBV1" jumper cap should be placed on pin 2-3.



Power Source Selection for USB: JUSBV1/ JUSBV2/ JUSBV3_4 (does not support on version 7.x)

JUSBV1/JUSBV2/ JUSBV3_4	Assignment	Description
 Pin 1-2 close	+5V	JUSBV1: 5V for USB at the JUSB1 connector port JUSBV2: 5V for USB at the JRJ45USB1 coonector port JUSBV3_4: 5V for USB at the JUSB23 connector ports
 Pin 2-3 close	+5V Standby Voltage	JUSBV1: JUSB1 port powered with standby v oltag e of 5V JUSBV2: JRJ45USB1 port powered with standby v oltag e of 5V

		JUSBV3_4: JUSB2/3 ports powered with standby voltage of 5V
--	--	--

Note: In order to support the function: "Power-on system via USB device", "JUSBV1/JUSBV2/ JUSBV3_4" jumper cap should be placed on pin 2-3 respectively.

Clear CMOS Jumper: JCMOS1

JCMOS1	Assignment
 Pin 1-2 Close	Normal Operation (default)
 Pin 2-3 Close	Clear CMOS Data

※ **Clear CMOS Procedures:**

1. Remove AC power line.
2. Set the jumper to "Pin 2-3 Close".
3. Wait for five seconds.
4. Set the jumper to "Pin 1-2 Close".
5. Power on the AC.
6. Reset your desired password or clear the CMOS data.

CD-ROM Audio-In Header: JCDIN1/(JCDIN2=>does not support on version 7.x)

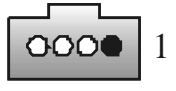
 JCDIN1/ JCDIN2	Pin	Assignment
	1	Left Channel Input
	2	Ground
	3	Ground
	4	Right Channel Input

Front Panel Audio Header: JAUDIO1

			
Pin	Assignment	Pin	Assignment
1	Mic In/ Center	2	Ground
3	Mic Power/ Bass	4	Audio Power
5	Right Line Out/ Speaker Out Right	6	Right Line Out/ Speaker Out Right
7	Reserv ed	8	Key
9	Left Line Out/ Speaker Out Left	10	Left Line Out/ Speaker Out Left
11	Right Line In/ Rear Speaker Right	12	Right Line In/ Rear Speaker Right
13	Left Line In/ Rear Speaker Left	14	Left Line In/ Rear Speaker Left

Digital Audio Connector: JSPDIF_OUT1 (optional for all versions)

		Pin	Assignment
JSPDIF_OUT1		1	+5V
		2	SPDIF_OUT
		3	Ground

Digital Audio Connector: JSPDIF_IN1 (optional for all versions)

		Pin	Assignment
JSPDIF_IN1		1	+5V
		2	SPDIF_IN
		3	Ground

Auxiliary Audio-In Connector: JAUX1 (only for version 7.x)

		Pin	Assignment
JAUX1		1	Left channel AUX_IN
		2	CD_Ground
		3	CD_Ground
		4	Righ channel AUX_IN

Consumer Infrared Header: J_CIR (only for version 7.x)

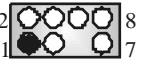
 <p>J_CIR</p>	Pin	Assignment	Pin	Assignment
	1	Ground	2	+5V Standby
	3	CIRRX	4	CIRTX
	5	Key	6	Power-on Button
	7	SMBDT	8	SMBCK

Wake On LAN Header: WO L1 (does not support on version 7.x)

 <p>WO L1</p>	Pin	Assignment
	1	+5V Standby
	2	Ground
	3	Wake up

Front USB Header: JUSB2/3

 <p>JUSB2/3</p>	Pin	Assignment	Pin	Assignment
	1	+5V	2	+5V
	3	USB-	4	USB-
	5	USB+	6	USB+
	7	Ground	8	Ground
	9	KEY	10	NC

Back Panel Connectors

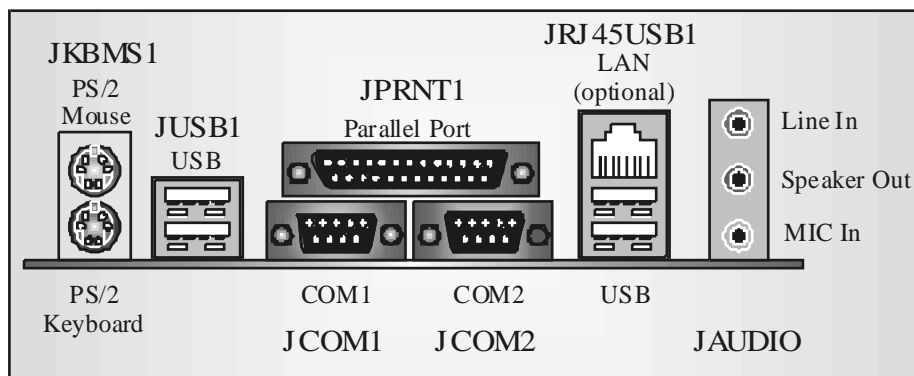

▶ for version 1.x

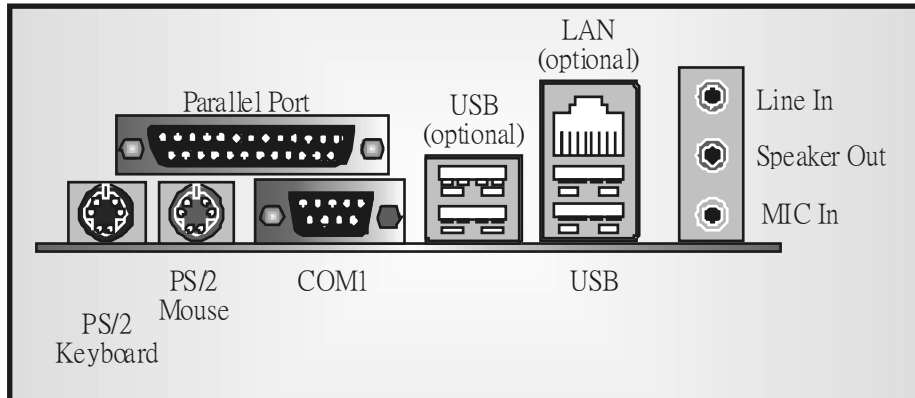

▶ for version 7.x

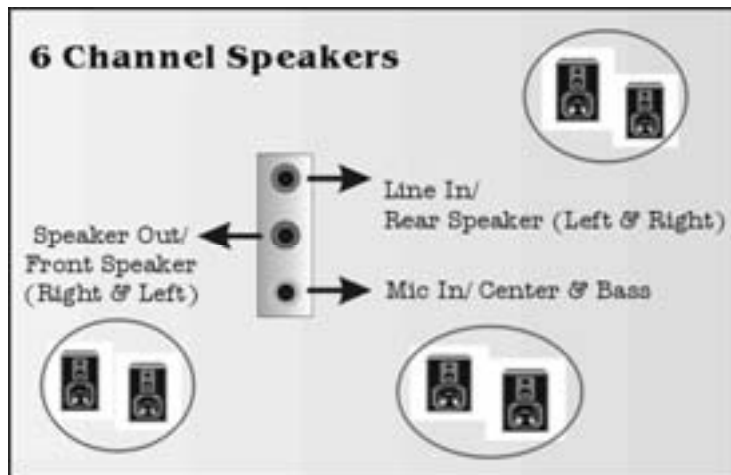

Français

Caractéristiques de P4TSE-D2

A. Matériel

Processeur

- Avec Socket 478.
- Supporte Intel® Pentium® 4 processeur jusqu' à 3.2GHz.
- FSB 400/ 533/ 800 MHz.
- Supporte technologie Hyper-Threading.
- Supporte processeur Intel® Pentium® 4 Northwood. (Willamette ne supporte pas)
- Supporte processeur Intel® Pentium® 4 478 Prescott. (seulement pour version au-dessus de 1.2)

Jeu de Puces

- North Bridge: Intel 865PE.
- South Bridge: Intel ICH5.

Mémoire Principale

- Supporte un ou deux canaux de données DDR de 64 bits de large avec 1 DIMM par canal.
- Bande passante disponible jusqu'à 3.2Go/s (DDR400) pour le mode canal simple et 6.4Go/s (DDR 400) pour mode canal double.
- Supporte les technologies DDR 128 Mo, 256 Mo, 512 Mo.
- Supporte seulement les périphériques DDR x8,x16. (Ne supporte pas les DIMM et ECC en registres)
- Supporte quatre banques de mémoire
- La taille maximum de la mémoire est de 2Go.

Super E/S

- Puce: ITE IT8712.
- Interface de Comptage de Broche Faible.
- Offre la fonctionnalité Super E/S héritée la plus couramment utilisée.
- Initiatives de Contrôle d'Environnement,
 - Moniteur H/W
 - Fonction "Smart Guardian" de ITE

Slots

- Cinq slots de maîtrise de bus PCI 32 bits.
- Un slot CNR (non disponible sur la version 7.x)
- Un slot compatible AGP 4X/8X.

IDE intégré

- Supporte quatre lecteurs de disque IDE.
- Supporte PIO Mode 4 et Ultra DMA 33/66/100 Bus Master Mode.

LAN (optionnel pour la version 1.x)

- Puce: RTL8100C/ RTL8110S.
- Supporte le fonctionnement en auto-négociation 10 Mb/s et 100 Mb/s. (avec puce LAN RTL8100C)
- Supporte l'auto-négociation 10 Mb/s, 100 Mb/s et 1000 Mb/s. (avec puce LAN RTL8110S) (optionnel)
- Capacité Half/Full duplex.
- Supporte la gestion d'alimentation ACPI, PCI.

LAN (seulement pour version 7.x)

- Puce: RTL8100C.
- Supporte le fonctionnement en auto-négociation 10Mb/s et 100 Mb/s.
- Capacité Half/ Full duplex.
- Supporte la gestion d'alimentation ACPI, PCI.

Codec Son AC'97 intégré (seulement pour version 1.x)

- Puce: CMI9739A.
- Conforme aux spécifications AC'97.
- Interface AC'97.
- Supporte 6 canaux.

Codec Son AC'97 intégré (pour la version 7.x seulement)

- Puce: CMI9761A
- Conforme aux spécifications Intel® AC'97 Rev 2.3.
- Répond aux exigences de Microsoft® PC2001.
- Supporte 6 canaux.
- Supporte le microphone stéréo.
- Gestion d'alimentation avancée et capacités d'économie d'énergie.
- Fonction S/PDIF Entrée/ Sortie:
 - Sortie : 96/ 48 kHz avec 24/ 20/ 16 bits
 - Entrée: 48/ 44,1 kHz avec 20/ 16 bits
 - Entrée S/PDIF est dotée du support des fonctionnalités d'interruption, auto-verrouillage, anti-bruit, et anti-distorsion.

Périphériques intégré

a. Côté arrière

- 2 ports série. (la version 7.x prend en charge seulement 1 port série)
- 1 port parallèle. (mode SPP/EPP/ECP)
- 1 port audio en position verticale.
- 1 port LAN. (optionnel)
- 1 souris PS/2.
- 1 clavier PS/2.
- 4 ports USB2.0.

b. Côté frontal

- 1 port disquette prenant en charge 2 FDD avec 360K, 720K, 1.2M, 1.44M et 2.88 Mo.

-
-
- 4 ports USB2.0.
 - 1 en-tête audio avant.
 - 1 Embase de Sortie S/PDIF. (optionnelle pour les deux versions)
 - 1 Embase d'Entrée S/PDIF. (optionnelle pour la version 7.x) (non disponible sur la version 1.x)
 - 1 Embase DJ Audio (non disponible sur la version 7.x)

Dimensions

- Facteur de forme ATX: 20.3 X 30.5cm (Larg X L) (pour version 1.x)
- Facteur de forme ATX: 20.4 X 29.5cm (Larg X L) (pour version 7.x)

B. BIOS et Logiciel

BIOS

- Award legal BIOS.
- APM1.2.
- ACPI.
- Fonction USB.

Logiciel

- Supports Wapspeeder™, 9th Touch™, WinFlasher™, BodBlocker™, FLASHER™ et StudioFun™ (optionnel).
- Offrant la meilleure performance pour Windows 98 SE, Windows 2000, Windows Me, Windows XP, UNIX series, etc.

WarpSpeeder™



Introduction

[WarpSpeeder™], a new powerful control utility, features three user-friendly functions including Overclock Manager, Overvoltage Manager, and Hardware Monitor.

With the Overclock Manager, users can easily adjust the frequency they prefer or they can get the best CPU performance with just one click. The Overvoltage Manager, on the other hand, helps to power up CPU core voltage and Memory voltage. The cool Hardware Monitor smartly indicates the temperatures, voltage and CPU fan speed as well as the chipset information. Also, in the About panel, you can get detail descriptions about BIOS model and chipsets. In addition, the frequency status of CPU, memory, AGP and PCI along with the CPU speed are synchronically shown on our main panel.

Moreover, to protect users' computer systems if the setting is not appropriate when testing and results in system fail or hang, [WarpSpeeder™] technology assures the system stability by automatically rebooting the computer and then restart to a speed that is either the original system speed or a suitable one.

System Requirement

OS Support: Windows 98 SE, Windows Me, Windows 2000, Windows XP

DirectX: DirectX 8.1 or above. (The Windows XP operating system includes DirectX 8.1. If you use Windows XP, you do not need to install DirectX 8.1.)

Installation

1. Execute the setup execution file, and then the following dialog will pop up. Please click "Next" button and follow the default procedure to install.

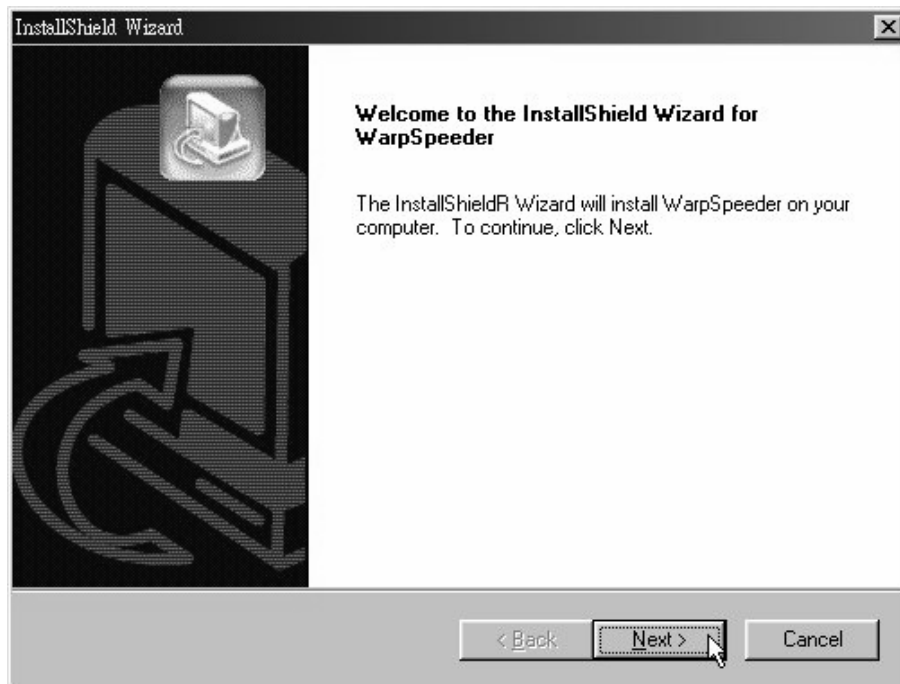

2. When you see the following dialog in setup procedure, it means setup is completed. If the "Launch the WarpSpeeder Tray Utility" checkbox is checked, the Tray Icon utility and [WarpSpeeder™] utility will be automatically and immediately launched after you click "Finish" button.



Usage

The following figures are just only for reference, the screen printed in this user manual will change according to your motherboard on hand.

[WarpSpeeder™] includes 1 tray icon and 5 panels:

1. Tray Icon:

Whenever the Tray Icon utility is launched, it will display a little tray icon on the right side of Windows Taskbar.

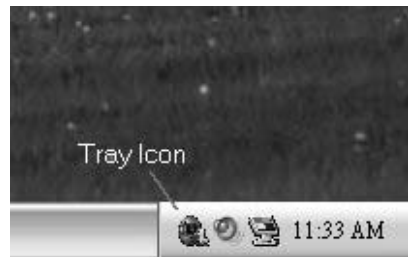

This utility is responsible for conveniently invoking [WarpSpeeder™] Utility. You can use the mouse by clicking the left button in order to invoke [WarpSpeeder™] directly from the little tray icon or you can right-click the little tray icon to pop up a popup menu as following figure. The “Launch Utility” item in the popup menu has the same function as mouse left-click on tray icon and “Exit” item will close Tray Icon utility if selected.



2. Main Panel

If you click the tray icon, [WarpSpeeder™] utility will be invoked. Please refer to the following figure; the utility's first window you will see is Main Panel.

Main Panel contains features as follows:

- a. Display the CPU Speed, CPU external clock, Memory clock, AGP clock, and PCI clock information.
- b. Contains About, Voltage, Overclock, and Hardware Monitor Buttons for invoking respective panels.
- c. With a user-friendly Status Animation, it can represent 3 overclock percentage stages:

Duck walking => overclock percentage from 100% ~ 110 %

Duck running => overclock percentage from 110% ~ 120%

Duck Burning => overclock percentage from 120% ~ above

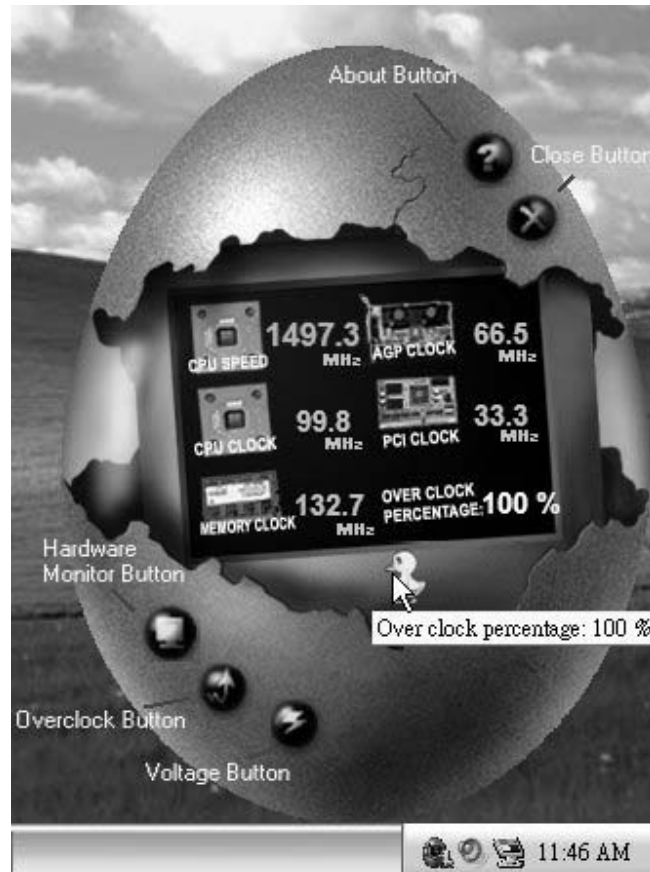

3. Voltage Panel

Click the Voltage button in Main Panel, the button will be highlighted and the Voltage Panel will slide out to up as the following figure.

In this panel, you can decide to increase CPU core voltage and Memory voltage or not. The default setting is "No". If you want to get the best performance of overclocking, we recommend you click the option "Yes".



4. Overclock Panel

Click the Overclock button in Main Panel, the button will be highlighted and the Overclock Panel will slide out to left as the following figure.



Overclock Panel contains the these features:

- a. “-3MHz button”, “-1MHz button”, “+1MHz button”, and “+3MHz button”: provide user the ability to do real-time overclock adjustment.

Warning: Manually overclock is potentially dangerous, especially when the overclocking percentage is over 110 %. We strongly recommend you verify every speed you overclock by click the Verify button. Or, you can just click Auto overclock button and let [WarpSpeeder™] automatically gets the best result for you.

- b. “Recovery Dialog button”: Pop up the following dialog. Let user select a restoring way if system need to do a fail-safe reboot.

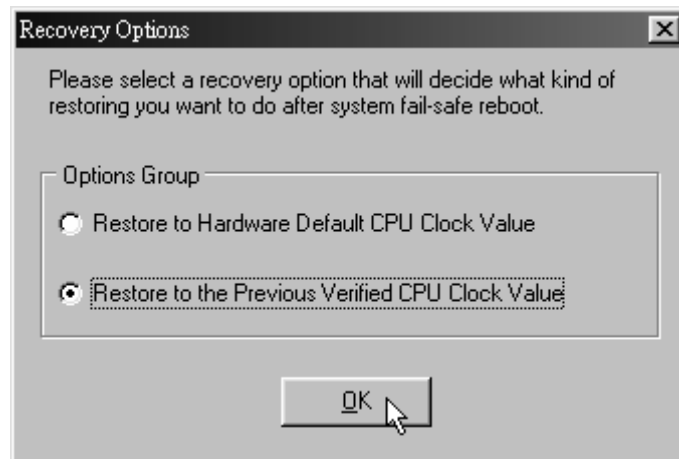

- c. "Auto-overclock button": User can click this button and [WarpSpeeder™] will set the best and stable performance and frequency automatically. [WarpSpeeder™] utility will execute a series of testing until system fail. Then system will do fail-safe reboot by using Watchdog function. After reboot, the [WarpSpeeder™] utility will restore to the hardware default setting or load the verified best and stable frequency according to the Recovery Dialog's setting.
- d. "Verify button": User can click this button and [WarpSpeeder™] will proceed a testing for current frequency. If the testing is ok, then the current frequency will be saved into system registry. If the testing fail, system will do a fail-safe rebooting. After reboot, the [WarpSpeeder™] utility will restore to the hardware default setting or load the verified best and stable frequency according to the Recovery Dialog's setting.

Note: Because the testing programs, invoked in Auto-overclock and Verify, include DirectDraw, Direct3D and DirectShow tests, the DirectX 8.1 or newer runtime library is required. And please make sure your display card's color depth is High color (16 bit) or True color (24/32 bit) that is required for Direct3D rendering.

5. Hardware Monitor Panel

Click the Hardware Monitor button in Main Panel, the button will be highlighted and the Hardware Monitor panel will slide out to left as the following figure.

In this panel, you can get the real-time status information of your system. The information will be refreshed every 1 second.



6. About Panel

Click the About button in Main Panel, the button will be highlighted and the About Panel will slide out to up as the following figure.

In this panel, you can get model name and detail information in hints of all the chipset that are related to overclocking. You can also get the mainboard's BIOS model and the Version number of [WarpSpeeder™] utility.

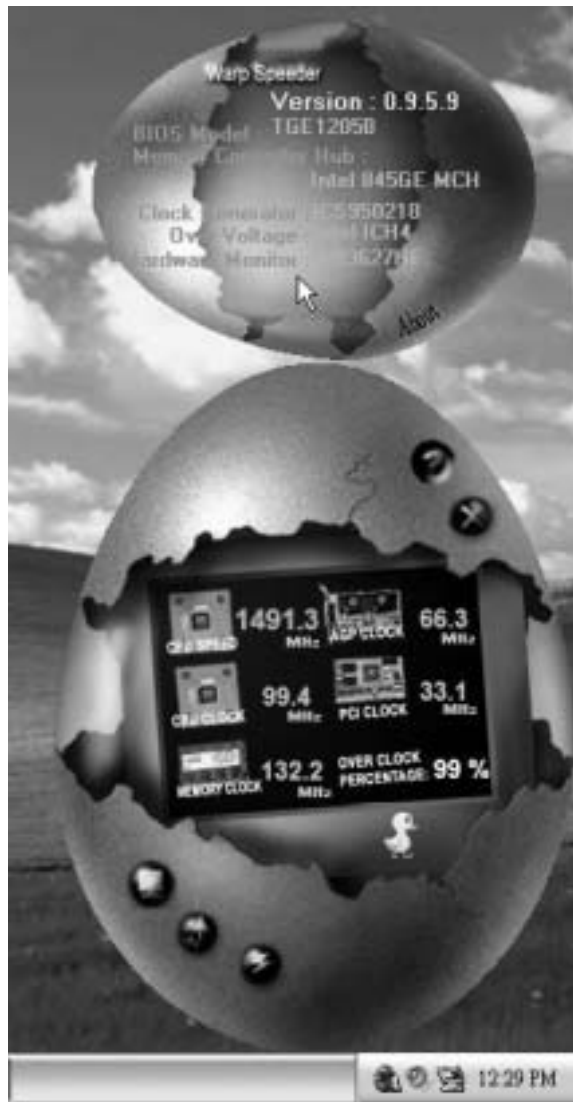

Note: Because the overclock, overvoltage, and hardware monitor features are controlled by several separate chipset, [WarpSpeeder™] divide these features to separate panels. If one chipset is not on board, the correlative button in Main panel will be disabled, but will not interfere other panels'

functions. This property can make [WarpSpeeder™] utility more robust.

Trouble Shooting

PROBABLE CAUSE	SOLUTION
No power to the system at all. Power light don't illuminate, fan inside power supply does not turn on. Indicator light on keyboard does not turn on.	<ul style="list-style-type: none"> * Make sure power cable is securely plugged in. * Replace cable. * Contact technical support.
System inoperative. Keyboard lights are on, power indicator lights are lit, hard drive is spinning.	<ul style="list-style-type: none"> * Using even pressure on both ends of the DIMM, press down firmly until the module snaps into place.
System does not boot from hard disk drive, can be booted from CD-ROM drive.	<ul style="list-style-type: none"> * Check cable running from disk to disk controller board. Make sure both ends are securely plugged in; check the drive type in the standard CMOS setup. * Backing up the hard drive is extremely important. All hard disks are capable of breaking down at any time.
System only boots from CD-ROM. Hard disk can be read and applications can be used but booting from hard disk is impossible.	<ul style="list-style-type: none"> * Back up data and applications files. Reformat the hard drive. Re-install applications and data using backup disks.
Screen message says "Invalid Configuration" or "CMOS Failure."	<ul style="list-style-type: none"> * Review system's equipment. Make sure correct information is in setup.
Cannot boot system after installing second hard drive.	<ul style="list-style-type: none"> * Set master/slave jumpers correctly. * Run SETUP program and select correct drive types. Call drive manufacturers for compatibility with other drives.

Dépannage

PROBLÈME	SOLUTION
Pas d'alimentation au système. Les voyants lumineux ne s'allument pas, le ventilateur à l'intérieur du bloc d'alimentation ne se met pas en marche. Le voyant du clavier ne s'allume pas	<ul style="list-style-type: none"> * Assurez-vous que le câble d'alimentation est bien branché * Remplacez le câble * Contactez le service d'assistance technique

PROBLÈME	SOLUTION
Le système ne fonctionne pas. Les voyants du clavier sont allumés, les voyants de l'alimentation aussi, le disque dur tourne.	<ul style="list-style-type: none"> * En exerçant une pression uniforme sur les deux extrémités du DIMM poussez le module vers le bas jusqu'à ce qu'il s'enclenche.

PROBLÈME	SOLUTION
Le système ne se réinitialise pas du disque dur, réinitialisation possible depuis le lecteur CD-ROM.	<ul style="list-style-type: none"> * Vérifiez le câble du disque à la carte du contrôleur de disque. Assurez-vous que les deux extrémités sont bien branchées ; vérifiez le type de lecteur dans la configuration standard de CMOS. * Il est très important d'effectuer des sauvegardes du disque dur. Les disques durs peuvent tomber en panne à n'importe quel moment.

PROBLÈME	SOLUTION
Le système ne se réinitialise que depuis le CD-ROM. Le disque dur peut être lu et les applications sont utilisables mais il est impossible d'effectuer de réinitialisation depuis le disque dur.	<ul style="list-style-type: none"> * Effectuez une sauvegarde des fichiers des données et d'application. Reformatez le disque dur. Ré-installez les applications et les données sauvegardées sur les disques de secours.

PROBLÈME	SOLUTION
Un message s'affiche indiquant que la configuration n'est pas valide ou qu'il y a une panne du CMOS.	<ul style="list-style-type: none"> * Vérifiez l'équipement du système. Assurez-vous que les informations de la configuration sont correctes.

PROBLÈME	SOLUTION
Impossible de réinitialiser le système après l'installation d'un deuxième disque dur.	<ul style="list-style-type: none"> * Réglez les cavaliers maître/esclave correctement. * Exécutez le programme SETUP et sélectionnez les types de lecteur. Contactez les fabricants pour toute question de compatibilité avec les autres disques.

12/31/2003

P4TSE-D2 BIOS Setup

BIOS Setup	1
1 Main Menu.....	3
2 Standard CMOS Features	6
3 Advanced BIOS Features.....	9
4 Advanced Chipset Features.....	12
5 Integrated Peripherals	15
6 Power Management Setup	19
7 PnP/PCI Configurations	23
8 PC Health Status	25
9 Frequency Control	27

P4TSE-D2 BIOS Setup

BIOS Setup

Introduction

This manual discussed Award™ Setup program built into the ROM BIOS. The Setup program allows users to modify the basic system configuration. This special information is then stored in battery-backed RAM so that it retains the Setup information when the power is turned off.

The Award BIOS™ installed in your computer system's ROM (Read Only Memory) is a custom version of an industry standard BIOS. This means that it supports Intel Pentium® 4 processor input/output system. The BIOS provides critical low-level support for standard devices such as disk drives and serial and parallel ports.

Adding important has customized the Award BIOS™, but nonstandard, features such as virus and password protection as well as special support for detailed fine-tuning of the chipset controlling the entire system.

The rest of this manual is intended to guide you through the process of configuring your system using Setup.

Plug and Play Support

These AWARD BIOS supports the Plug and Play Version 1.0A specification. ESCD (Extended System Configuration Data) write is supported.

EPA Green PC Support

This AWARD BIOS supports Version 1.03 of the EPA Green PC specification.

APM Support

These AWARD BIOS supports Version 1.1&1.2 of the Advanced Power Management (APM) specification. Power management features are implemented via the System Management Interrupt (SMI). Sleep and Suspend power management modes are supported. This AWARD BIOS can manage power to the hard disk drives and video monitors .

ACPI Support

Award ACPI BIOS support Version 1.0 of Advanced Configuration and Power interface specification (ACPI). It provides ASL code for power management and device configuration capabilities as defined in the ACPI specification, developed by Microsoft, Intel and Toshiba.

P4TSE-D2 BIOS Setup

PCI Bus Support

This AWARD BIOS also supports Version 2.1 of the Intel PCI (Peripheral Component Interconnect) local bus specification.

DRAM Support

DDR DRAM (Double Data Rate Synchronous DRAM) are supported.

Supported CPUs

This AWARD BIOS supports the Intel Pentium® 4 CPU.

Using Setup

In general, you use the arrow keys to highlight items, press <Enter> to select, use the <PgUp> and <PgDn> keys to change entries, press <F1> for help and press <Esc> to quit. The following table provides more detail about how to navigate in the Setup program by using the keyboard.

Keystroke	Function
Up arrow	Move to previous item
Down arrow	Move to next item
Left arrow	Move to the item on the left (menu bar)
Right arrow	Move to the item on the right (menu bar)
Move Enter	Move to the item you desired
PgUp key	Increase the numeric value or make changes
PgDn key	Decrease the numeric value or make changes
+ Key	Increase the numeric value or make changes
- Key	Decrease the numeric value or make changes
Esc key	Main Menu – Quit and not save changes into CMOS Status Page Setup Menu and Option Page Setup Menu – Exit Current page and return to Main Menu
F1 key	General help on Setup navigation keys
F5 key	Load previous values from CMOS
F7 key	Load the optimized defaults
F10 key	Save all the CMOS changes and exit

P4TSE-D2 BIOS Setup

1 Main Menu

Once you enter Award BIOS™ CMOS Setup Utility, the Main Menu will appear on the screen. The Main Menu allows you to select from several setup functions. Use the arrow keys to select among the items and press <Enter> to accept and enter the sub-menu.

⚠WARNING

The information about BIOS defaults on this manual (**Figure 1,2,3,4,5,6,7,8,9**) is just only for reference, please refer to the BIOS installed on board for update information.

■ **Figure 1. Main Menu**

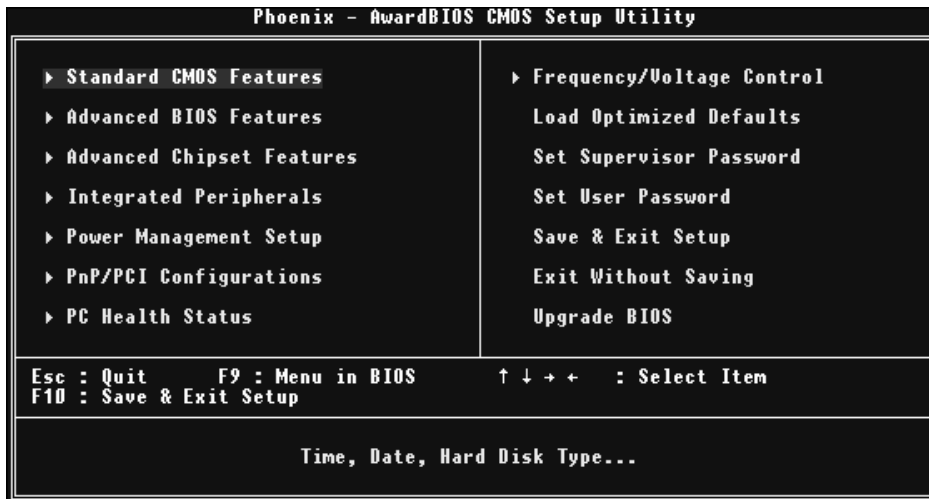

Standard CMOS Features

This submenu contains industry standard configurable options.

Advanced BIOS Features

This submenu allows you to configure enhanced features of the BIOS.

Advanced Chipset Features

This submenu allows you to configure special chipset features.

P4TSE-D2 BIOS Setup

Integrated Peripherals

This submenu allows you to configure certain IDE hard drive options and Programmed Input/ Output features.

Power Management Setup

This submenu allows you to configure the power management features.

PnP/PCI Configurations

This submenu allows you to configure certain "Plug and Play" and PCI options.

PC Health Status

This submenu allows you to monitor the hardware of your system.

Frequency Control

This submenu allows you to change CPU Vcore Voltage and CPU/PCI clock. **(However, this function is strongly recommended not to use. Not properly change the voltage and clock may cause CPU or M/B damage!)**

Load Optimized Defaults

This selection allows you to reload the BIOS when the system is having problems particularly with the boot sequence. These configurations are factory settings optimized for this system. A confirmation message will be displayed before defaults are set.



```
Load Optimized Defaults (Y/N)? N
```

Set Supervisor Password

Setting the supervisor password will prohibit everyone except the supervisor from making changes using the CMOS Setup Utility. You will be prompted with to enter a password.



```
Enter Password:
```

Set User Password

If the Supervisor Password is not set, then the User Password will function in the same way as the Supervisor Password. If the Supervisor Password is set and the User Password is set, the "User" will only be able to view configurations but will not be able to change them.



```
Enter Password:
```

P4TSE-D2 BIOS Setup

Save & Exit Setup

Save all configuration changes to CMOS(memory) and exit setup. Confirmation message will be displayed before proceeding

```
SAVE to CMOS and EXIT (Y/N)? Y
```

Exit Without Saving

Abandon all changes made during the current session and exit setup. Confirmation message will be displayed before proceeding

```
Quit Without Saving (Y/N)? N
```

Upgrade BIOS

This submenu allows you to upgrade bios.

```
BIOS UPDATE UTILITY (Y/N)? N
```

P4TSE-D2 BIOS Setup

2 Standard CMOS Features

The items in Standard CMOS Setup Menu are divided into 10 categories. Each category includes no, one or more than one setup items. Use the arrow keys to highlight the item and then use the <PgUp> or <PgDn> keys to select the value you want in each item.

■ **Figure 2. Standard CMOS Setup**

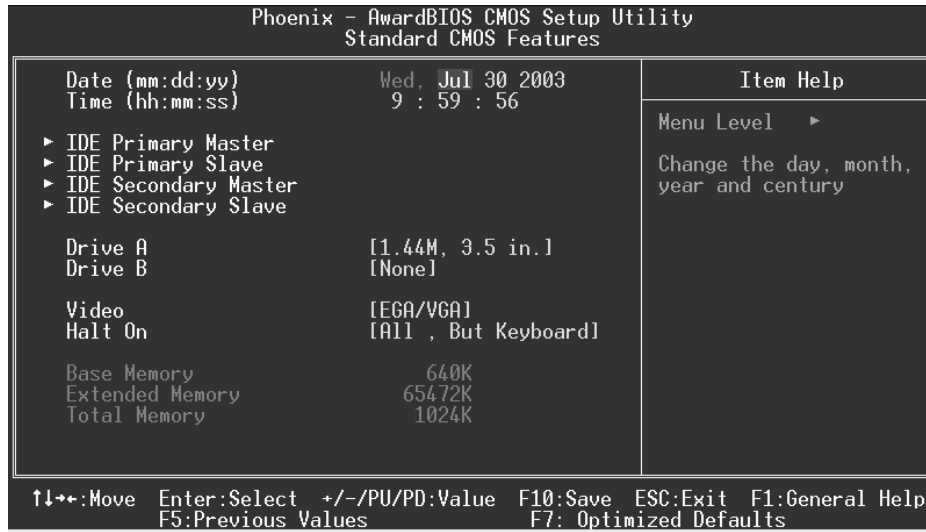

P4TSE-D2 BIOS Setup

Main Menu Selections

This table shows the selections that you can make on the Main Menu.

Item	Options	Description
Date	mm : dd : yy	Set the system date. Note that the 'Day' automatically changes when you set the date.
Time	hh : mm : ss	Set the system internal clock.
IDE Primary Master	Options are in its sub menu.	Press <Enter> to enter the sub menu of detailed options
IDE Primary Slave	Options are in its sub menu.	Press <Enter> to enter the sub menu of detailed options.
IDE Secondary Master	Options are in its sub menu.	Press <Enter> to enter the sub menu of detailed options.
IDE Secondary Slave	Options are in its sub menu.	Press <Enter> to enter the sub menu of detailed options.
Drive A Drive B	360K, 5.25 in 1.2M, 5.25 in 720K, 3.5 in 1.44M, 3.5 in 2.88M, 3.5 in None	Select the type of floppy disk drive installed in your system.
Video	EGA/VGA CGA 40 CGA 80 MONO	Select the default video device.

P4TSE-D2 BIOS Setup

Item	Options	Description
Halt On	All Errors No Errors All, but Keyboard All, but Diskette All, but Disk/ Key	Select the situation in which you want the BIOS to stop the POST process and notify you.
Base Memory	N/A	Displays the amount of conventional memory detected during boot up.
Extended Memory	N/A	Displays the amount of extended memory detected during boot up.
Total Memory	N/A	Displays the total memory available in the system.

P4TSE-D2 BIOS Setup

3 Advanced BIOS Features

■ Figure 3. Advanced BIOS Setup

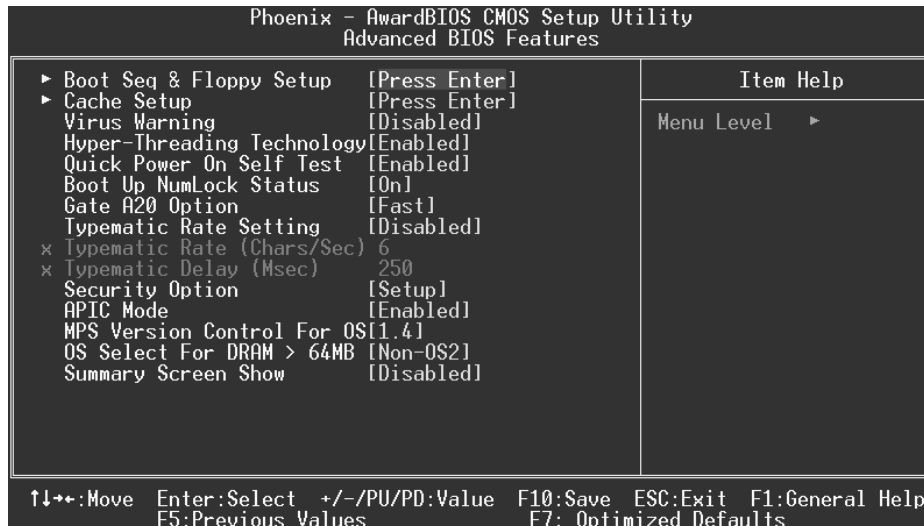

Boot Seq & Floppy Setup

First/ Second/ Third/ Boot Other Device

These BIOS attempt to load the operating system from the device in the sequence selected in these items.

The Choices: Floppy, LS120, HDD-0, SCSI, CDROM, HDD-1, HDD-2, HDD-3, ZIP100, LAN, HPT370, Disabled, Enabled.

Swap Floppy Drive

For systems with two floppy drives, this option allows you to swap logical drive assignments.

The Choices: Disabled (default), Enabled.

Boot Up Floppy Seek

Enabling this option will test the floppy drives to determine if they have 40 or 80 tracks. Disabling this option reduces the time it takes to boot-up.

The Choices: Disabled, Enabled (default).

Report NO FDD for Win95

The Choices: NO (default).

P4TSE-D2 BIOS Setup

Cache Setup

CPU L1 & L2 Cache

Depending on the CPU/ chipset in use, you may be able to increase memory access time with this option.

Enabled (default)	Enable cache.
Disabled	Disable cache.

Virus Warning

This option allows you to choose the Virus Warning feature that is used to protect the IDE Hard Disk boot sector. If this function is enabled and an attempt is made to write to the boot sector, BIOS will display a warning message on the screen and sound an alarm beep.

Enabled	Virus protection is activated.
Disabled (default)	Virus protection is disabled.

Hyper-Threading Technology

This option allows you to enable or disabled Hyper-Threading Technology. “Enabled” for Windows XP and Linux 2.4.x (OS optimized for Hyper-Threading Technology). “Disable” for other OS (OS not optimized for Hyper-Threading Technology).

The Choices: Enabled (Default), Disabled.

Quick Power On Self Test

Enabling this option will cause an abridged version of the Power On Self-Test (POST) to execute after you power up the computer.

Disabled	Normal POST.
Enabled (default)	Enable quick POST.

Boot Up NumLock Status

Selects the NumLock. State after power on.

On (default)	Numpad is number keys.
Off	Numpad is arrow keys.

Gate A20 Option

Select if chipset or keyboard controller should control Gate A20.

Normal	A pin in the keyboard controller controls Gate A20.
Fast (default)	Lets chipset control Gate A20.

Typematic Rate Setting

When a key is held down, the keystroke will repeat at a rate determined by the keyboard controller. When enabled, the typematic rate and typematic delay can be configured.

The Choices: Disabled (default), Enabled.

P4TSE-D2 BIOS Setup

Typematic Rate (Chars/Sec)

Sets the rate at which a keystroke is repeated when you hold the key down.

The Choices: 6 (default), 8,10,12,15,20,24,30.

Typematic Delay (Msec)

Sets the delay time after the key is held down before it begins to repeat the keystroke.

The Choices: 250 (default), 500,750,1000.

Security Option

This option will enable only individuals with passwords to bring the system online and/or to use the CMOS Setup Utility.

System

A password is required for the system to boot and is also required to access the Setup Utility.

Setup (default)

A password is required to access the Setup Utility only.

This will only apply if passwords are set from the Setup main menu.

APIC Mode

Selecting Enabled enables ACPI device mode reporting from the BIOS to the operating system.

The Choices: Enabled (default), Disabled.

MPS Version Control For OS

The BIOS supports version 1.1 and 1.4 of the Intel multiprocessor specification.

Select version supported by the operation system running on this computer.

The Choices: 1.4 (default), 1.1.

OS Select For DRAM > 64MB

A choice other than Non-OS2 is only used for OS2 systems with memory exceeding 64MB.

The Choices: Non-OS2 (default), OS2.

Summary Screen Show

This item allows you to enable/disable the summary screen. Summary screen means system configuration and PCI device listing.

The choices: Enabled, Disabled (default).

P4TSE-D2 BIOS Setup

4 Advanced Chipset Features

This submenu allows you to configure the specific features of the chipset installed on your system. This chipset manage bus speeds and access to system memory resources, such as DRAM. It also coordinates communications with the PCI bus. The default settings that came with your system have been optimized and therefore should not be changed unless you are suspicious that the settings have been changed incorrectly.

■ Figure 4. Advanced Chipset Setup

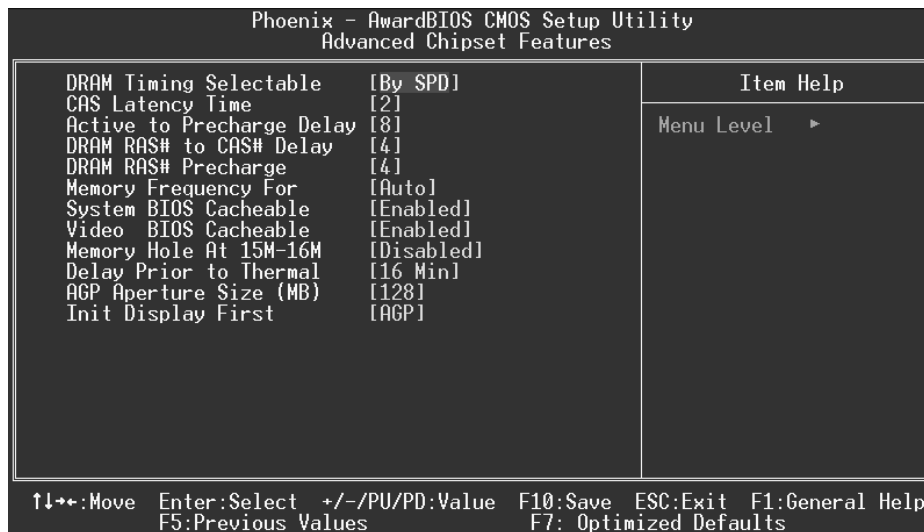

DRAM Timing Selectable

When synchronous DRAM is installed, the number of clock cycles of CAS latency depends on the DRAM timing.

The Choices: By SPD (default), Manual.

CAS Latency Time

When synchronous DRAM is installed, the number of clock cycles of CAS latency depends on the DRAM timing.

The Choices: 1.5, 2 (default), 2.5, 3.

Active to Precharge Delay

This item controls the number of DRAM clocks to activate the precharge delay.

The Choices: 8 (default), 7, 6, 5

P4TSE-D2 BIOS Setup

DRAM RAS# to CAS# Delay

This field let you insert a timing delay between the CAS and RAS strobe signals, used when DRAM is written to, read from, or refreshed. Fast gives faster performance; and slow gives more stable performance. This field applies only when synchronous DRAM is installed in the system.

The Choices: 4 (default), 3, 2.

DRAM RAS# Precharge

If an insufficient number of cycle is allowed for RAS to accumulate its charge before DRAM refresh, the refresh may be incomplete, and the DRAM may fail to retain data. Fast gives faster performance; and Slow gives more stable performance. This field applies only when synchronous DRAM is installed in the system.

The Choices: 4 (default), 3, 2.

Memory Frequency For

This item allows you to select the Memory Frequency.

The Choices: Auto (default), DDR266, DDR300, DDR400.

System BIOS Cacheable

Selecting Enabled allows you caching of the system BIOS ROM at F0000h~FFFFh, resulting a better system performance. However, if any program writes to this memory area, a system error may result.

The Choices: Enabled (default), Disabled.

Video BIOS Cacheable

Select Enabled allows caching of the video BIOS, resulting a better system performance. However, if any program writes to this memory area, a system error may result.

The Choices: Disabled, Enabled (default).

Video RAM Cacheable

This option allows you to enable or disable VGA RAM cache capability.

The Choices: Disabled (default), Enabled

Memory Hole At 15M-16M

You can reserve this area of system memory for ISA adapter ROM. When this area is reserved it cannot be cached. The user information of peripherals that need to use this area of system memory usually2 discussed their memory requirements.

The Choices: Disabled (default), Enabled.

Delay Prior to Thermal

Set this item to enable the CPU Thermal function to engage after the specified time.

The Choices: 4 Min, 8 Min, 16 Min (default), 32 Min.

P4TSE-D2 BIOS Setup

AGP Aperture Size (MB)

Select the size of the Accelerated Graphics Port (AGP) aperture. The aperture is a portion of the PCI memory address range dedicated for graphics memory address space. Host cycles that hit the aperture range are forwarded to the AGP without any translation.

The Choices: 64, 4, 8, 16, 32, **128** (default), 256.

Init Display First

This item allows you to decide to active whether PCI Slot or on-chip VGA first.

The Choices: **AGP** (default), PCI Slot.

P4TSE-D2 BIOS Setup

5 Integrated Peripherals

■ Figure 5. Integrated Peripherals

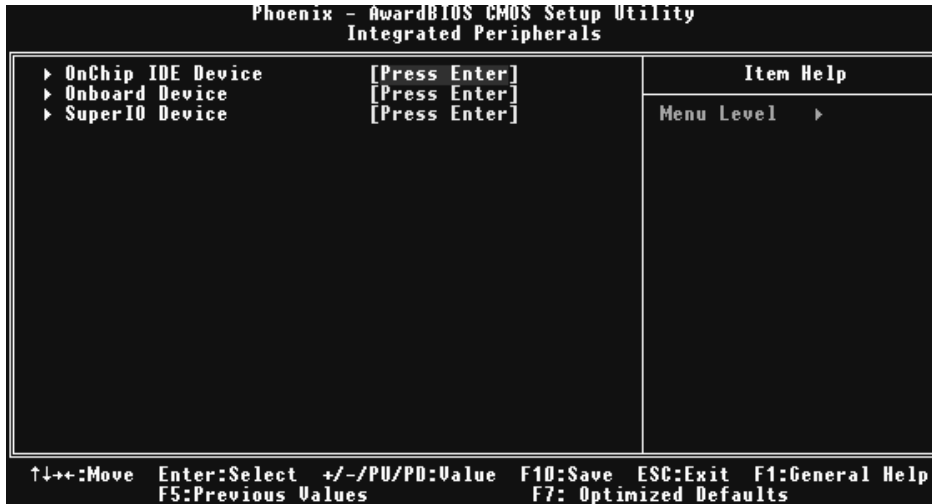

Onboard IDE Device

Press Enter to configure the onboard IDE Controllers.

IDE HDD Block Mode

Block mode is also called block transfer, multiple commands, or multiple sector read / write. If your IDE hard drive supports block mode (most new drives do), select Enabled for automatic detection of the optimal number of block mode (most new drives do), select Enabled for automatic detection of the optimal number of block read / write per sector where the drive can support.

The Choices: Enabled (default), Disabled.

IDE DMA transfer access

The Choices: Enabled (default), Disabled.

On-Chip Primary/ Secondary PCI IDE

This item allows you to enable or disable the primary/ secondary IDE Channel.

The Choices: Enabled (Default), Disabled.

Primary / Secondary /Master / Slave PIO

The IDE PIO (Programmed Input / Output) fields let you set a PIO mode (0-4) for each of the IDE devices that the onboard IDE interface supports. Modes 0 to 4 will increased performance progressively. In Auto mode, the system

P4TSE-D2 BIOS Setup

automatically determines the best mode for each device.

The Choices: Auto (default), Mode0, Mode1, Mode2, Mode3, Mode4.

Primary / Secondary /Master / Slave UDMA

Ultra DMA/100 functionality can be implemented if it is supported by the IDE hard drives in your system. As well, your operating environment requires a DMA driver (Windows 95 OSR2 or a third party IDE bus master driver). If your hard drive and your system software both support Ultra DMA/100, select Auto to enable BIOS support.

The Choices: Auto (default), Disabled.

On-Chip Serial ATA

This item allows you to choose "Disabled" to disabled SATA Controller, "Auto" auto arrange by bios, "Combined Mode" PATA and SATA are combined with a maximum of 2 IDE drives in each channels, "Enhanced Mode" enabled SATA and PATA with a maximum of 6 IDE drives, "SATA Only" SATA is operating in legacy mode.

The Choices: Auto (default), Disabled, Combined Mode, Enhanced Mode, SATA Only.

Serial ATA Port0/1 Mode

The Choices: Primary Master(default), Primary Slave, Secondary Master, Secondary Slave, SATA0 Master, SATA1 Master.

Onboard Device

Press Enter to configure the onboard Device.

USB Controller

Select Enabled if your system contains a Universal Serial Bus (USB) controller and you have USB peripherals.

The Choices: Enabled (default), Disabled

USB 2.0 Controller

The Choices: enabled (default), disabled.

USB Keyboard/Mouse Support

This item allows you to enable or disable the USB Keyboard/ Mouse Legacy Support.

Enabled	Enable USB Keyboard/Mouse Support.
Disabled (default)	Disable USB Keyboard/Mouse Support.

AC97 Audio

This item allows you to decide to enable/ disable to support AC97 Audio.

The Choices: Auto (default), Disabled.

P4TSE-D2 BIOS Setup

AC97 Modem (does not support on version 7.x)

This item allows you to decide to enable/ disable to support AC97 Modem.

The Choices: **Auto** (default), Disabled.

Onboard PCI LAN

This item allows you to enable or disable the onboard PCI LAN.

The Choices: **Enabled** (default), disabled.

Onboard LAN Boot ROM

Decide whether to invoke the boot ROM of the onboard LAN chip.

The Choices: Disabled, **Enable** (default).

Super IO Device

Press Enter to configure the Super I/O Device.

Power On Function (does not support on version 7.x)

This item allows you to choose the power on function.

The Choices: **Button Only** (default), Password, Hot Key, Mouse Left, Mouse Right, Any Key, Keyboard 98.

KB Power on Password (does not support on version 7.x)

Input password and press Enter to set the Keyboard power on password .

HOT Key power ON (does not support on version 7.x)

Input password and press Enter to set the Keyboard power on password .

The Choices: **Ctrl-F1**(default) , Ctrl-F2 , Ctrl-F3 , Ctrl-F4 , Ctrl-F5, Ctrl-F6 , Ctrl-F7 , Ctrl-F8 , Ctrl-F9, Ctrl-F10 , Ctrl-F11 , Ctrl-F12 .

Onboard FDC Controller

Select Enabled if your system has a floppy disk controller (FDC) installed on the system board and you wish to use it. If install and FDC or the system has no floppy drive, select Disabled in this field.

The Choices: **Enabled** (default), Disabled.

Onboard Serial Port 1

Select an address and corresponding interrupt for the first and second serial ports.

The Choices: **3F8/IRQ4** (default), Disabled, Auto, 2F8/IRQ3, 3E8/IRQ4, 2E8/IRQ3.

Onboard Serial Port 2

Select an address and corresponding interrupt for the first and second serial ports

The Choices: **2F8/IRQ3** (default), Disabled, Auto, 3F8/IRQ4 , 3E8/IRQ4, 2E8/IRQ3.

UART Mode Select

This item allows you to determine which Infrared (IR) function of onboard I/O

P4TSE-D2 BIOS Setup

chip.

The Choices: **Normal** (default) (does not support on version 7.x), ASKIR, IrDA, SCR (does not support on version 7.x).

UR2 Duplex Mode

Select the value required by the IR device connected to the IR port. Full-duplex mode permits simultaneous two-direction transmission. Half-duplex mode permits transmission in one direction only at a time.

The Choices: **Half** (default), Full.

Onboard Parallel Port

This item allows you to determine access onboard parallel port controller with which I/O Address.

The Choices: **378/IRQ7** (default), 278/IRQ5, 3BC/IRQ7, Disabled.

Parallel Port Mode

The default value is SPP.

SPP (default)	Using Parallel port as Standard Printer Port.
EPP	Using Parallel Port as Enhanced Parallel Port.
ECP	Using Parallel port as Extended Capabilities Port.
ECP+EPP	Using Parallel port as ECP & EPP mode.

ECP Mode Use DMA

Select a DMA Channel for the port.

The Choices: **3** (default), 1.

Power After Power Fail

This setting specifies whether your system will reboot after a power fail or interrupts occurs.

off	Leaves the computer in the power off state.
on	Reboots the computer.
Former-Sts	Restores the system to the status before power failure or interrupt occurs.

The Choices: **off** (default), on, Former-Sts.

Game Port Address (does not support on version 7.x)

Game Port I/O Address.

The Choices: **201** (default), 209, Disabled.

Midi Port Address (does not support on version 7.x)

Midi Port Base I/O Address.

The Choices: **330** (default), 300, Disabled.

Midi Port IRQ (does not support on version 7.x)

This determines the IRQ in which the Midi Port can use.

The Choices: **10** (default), 5.

P4TSE-D2 BIOS Setup

6 Power Management Setup

The Power Management Setup Menu allows you to configure your system to utilize energy conservation and power up/power down features.

■ **Figure 6. Power Management Setup**

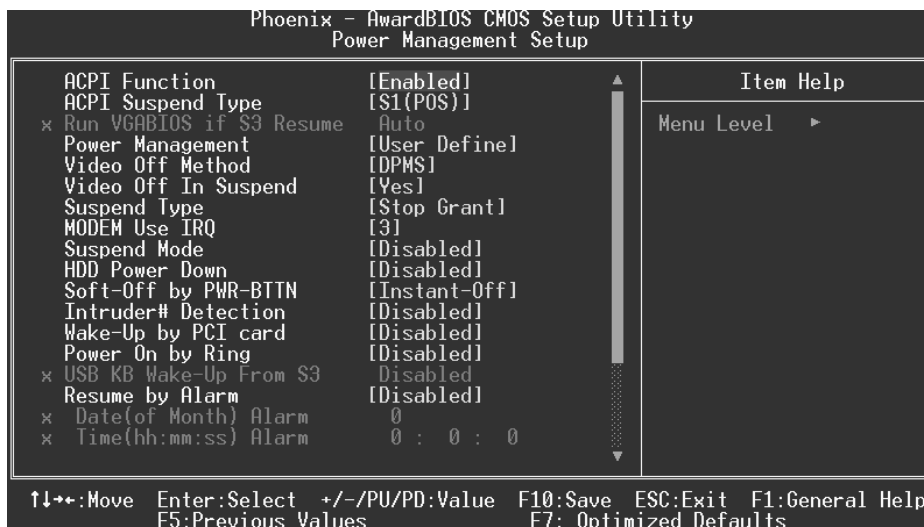

ACPI Function

This item displays the status of the Advanced Configuration and Power Management (ACPI).

The Choices: Enabled (default), Disabled.

ACPI Suspend Type (does not support on version 7.x)

The item allows you to select the suspend type under the ACPI operating system.

The Choices: S1 (POS) Power on Suspend
S3 (STR) Suspend to RAM
S1 & S3 POS+STR

Run VGABIOS if S3 Resume

Choosing Enabled will make BIOS run VGA BIOS to initialize the VGA card when system wakes up from S3 state. The system time is shortened if you disable the function, but system will need AGP driver to initialize the card. So, if the AGP driver of the VGA card does not support the initialization feature, the display may work abnormally or not function after S3.

The Choices: Auto (default), Yes, No.

P4TSE-D2 BIOS Setup

Power Management

This category allows you to select the type (or degree) of power saving and is directly related to the following modes:

- 1.HDD Power Down.
- 2.Doze Mode.
- 3.Suspend Mode.

There are four options of Power Management, three of which have fixed mode settings

Min. Saving

Minimum power management.

Doze Mode = 1 hr.

Standby Mode = 1 hr

Suspend Mode = 1 hr.

HDD Power Down = 15 min

Max Saving

Maximum power management only available for sl CPU's.

Doze Mode = 1 min

Standby Mode = 1 min.

Suspend Mode = 1 min.

HDD Power Down = 1 min.

User Defined (default)

Allows you to set each mode individually.

When not disabled, each of the ranges are from 1 min. to 1 hr. except for HDD Power Down which ranges from 1 min. to 15 min. and disable.

Video Off Method

This option determines the manner in which the monitor is goes blank.

V/H SYNC+Blank

This selection will cause the system to turn off the vertical and horizontal synchronization ports and write blanks to the video buffer.

Blank Screen

This option only writes blanks to the video buffer.

DPMS (default)

Initial display power management signaling

P4TSE-D2 BIOS Setup

Video Off In Suspend

This determines the manner in which the monitor is blanked.

The Choices: Yes (default), No.

Suspend Type

Select the Suspend Type.

The Choices: Stop Grant (default, PwrOn Suspend).

MODEM Use IRQ

This determines the IRQ, which can be applied in MODEM use.

The Choices:3 (default)/ 4 / 5 / 7 / 9 / 10 / 11 / NA.

Suspend Mode

When enabled and after the set time of system inactivity, all devices except the CPU will be shut off.

The Choices: Disabled (default), 1Min, 2Min, 4Min, 8Min, 12Min, 20Min, 30Min, 40Min, 1Hour.

HDD Power Down

When enabled and after the set time of system inactivity , the hard disk drive will be powered down while all other devices remain active.

The Choices: Disabled (default), 1Min, 2Min, 3Min, 4Min, 5Min, 6Min, 7Min, 8Min, 9Min, 10Min, 11Min, 12Min, 13Min, 14Min, 15Min.

Soft-Off by PWR-BTTN

Pressing the power button for more than 4 seconds forces the system to enter the Soft-Off state when the system has "hung."

The Choices: Delay 4 Sec, Instant-Off (default).

Intruder# Detection

This item allows you to enabled or disable intruder# detection

The Choices: Disabled (default), Enabled.

Wake-Up by PCI card

When you select Enable, a PME signal from PCI card returns the system to Full On state.

The Choices: Enabled, Disabled (default).

Power On by Ring

An input signal on the serial Ring Indicator (RI) line (in other words, an

P4TSE-D2 BIOS Setup

incoming call on the modem) awakens the system from a soft off state.

The Choices: Enabled, **Disabled** (default).

USB Keyboard/ Mouse Wake-Up from S3 (does not support on version 7.x)

This item allows you to enable or disabled wake up from S3 from USB keyboard/ Mouse.

The Choices: **Disabled** (Default), Enabled.

Resume by Alarm

This function is for setting date and time for your computer to boot up. During Disabled, you cannot use this function. During Enabled, Choose the Date and Time.

Alarm: **Date (of Month) Alarm** You can choose which month the system will boot up.

Time (hh:mm:ss) Alarm You can choose what hour, minute and second the system will boot up.

Note: If you have change the setting, you must let the system boot up until it goes to the operating system, before this function will work.

Reload Global Timer Event

Reload Global Timer Events are I/O events whose occurrence can prevent the system from entering a power saving mode or can awaken the system from such a mode. In effect, the system remains alert for anything, which occurs to a device, which is configured as *Enabled*, even when the system is in a power down mode.

Primary IDE 0/1

Secondary IDE 0/1

FDD, COM, LPT Port

PCI PIRQ [A-D]#

P4TSE-D2 BIOS Setup

7 PnP/PCI Configurations

This section describes configuring the PCI bus system. PCI, or Personal Computer Interconnect, is a system which allows I/O devices to operate at speeds nearing the speed of the CPU itself uses when communicating with its own special components. This section covers some very technical items and it is strongly recommended that only experienced users should make any changes to the default settings.

■ Figure 7. PnP/PCI Configurations

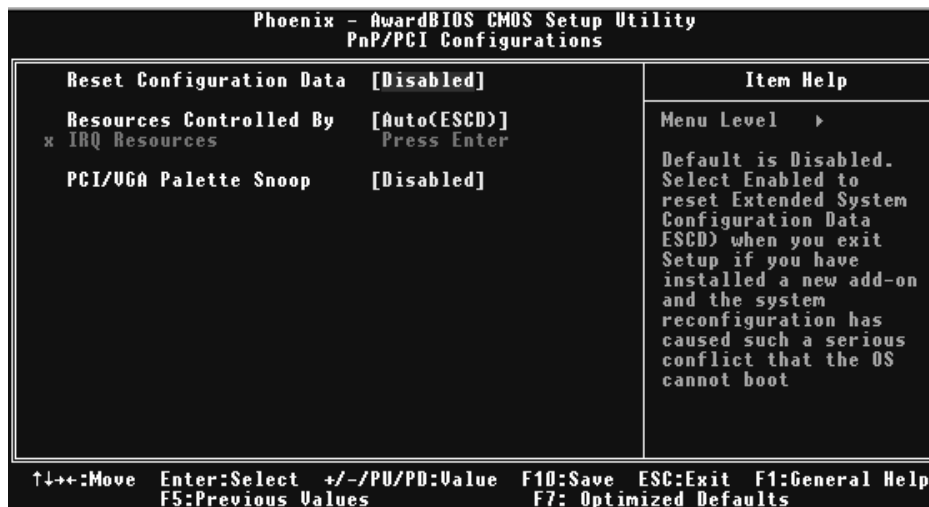

Reset Configuration Data

The system BIOS supports the PnP feature which requires the system to record which resources are assigned and protects resources from conflict. Every peripheral device has a node, which is called ESCD. This node records which resources are assigned to it. The system needs to record and update ESCD to the memory locations. These locations (4K) are reserved in the system BIOS. If the Disabled (default) option is chosen, the system's ESCD will update only when the new configuration varies from the last one. If the Enabled option is chosen, the system is forced to update ESCDs and then is automatically set to the "Disabled" mode.

The above settings will be shown on the screen only if "Manual" is chosen for the resources controlled by function.

Legacy is the term, which signifies that a resource is assigned to the ISA Bus and provides non-PnP ISA add-on cards. PCI / ISA PnP signifies that a resource is assigned to the PCI Bus or provides for ISA PnP add-on cards and peripherals.

The Choices: Disabled (default), Enabled.

P4TSE-D2 BIOS Setup

Resources Controlled By

By Choosing “**Auto(ESCD)**” (default), the system BIOS will detect the system resources and automatically assign the relative IRQ and DMA channel for each peripheral. By Choosing “**Manual**”, the user will need to assign IRQ & DMA for add-on cards. Be sure that there are no IRQ/DMA and I/O port conflicts.

IRQ Resources

This submenu will allow you to assign each system interrupt a type, depending on the type of device using the interrupt. When you press the “Press Enter” tag, you will be directed to a submenu that will allow you to configure the system interrupts. This is only configurable when “Resources Controlled By” is set to “Manual”.

IRQ-3	assigned to	PCI Device
IRQ-4	assigned to	PCI Device
IRQ-5	assigned to	PCI Device
IRQ-7	assigned to	PCI Device
IRQ-9	assigned to	PCI Device
IRQ-10	assigned to	PCI Device
IRQ-11	assigned to	PCI Device
IRQ-12	assigned to	PCI Device
IRQ-14	assigned to	PCI Device
IRQ-15	assigned to	PCI Device

PCI / VGA Palette Snoop

Choose Disabled or Enabled. Some graphic controllers which are not VGA compatible take the output from a VGA controller and map it to their display as a way to provide boot information and VGA compatibility.

However, the color information coming from the VGA controller is drawn from the palette table inside the VGA controller to generate the proper colors, and the graphic controller needs to know what is in the palette of the VGA controller. To do this, the non-VGA graphic controller watches for the Write access to the VGA palette and registers the snoop data. In PCI based systems, where the VGA controller is on the PCI bus and a non-VGA graphic controller is on an ISA bus, the Write Access to the palette will not show up on the ISA bus if the PCI VGA controller responds to the Write.

In this case, the PCI VGA controller should not respond to the Write, it should only snoop the data and permit the access to be forwarded to the ISA bus. The non-VGA ISA graphic controller can then snoop the data on the ISA bus. Unless you have the above situation, you should disable this option.

Disabled (default)	Disables the function.
Enabled	Enables the function.

P4TSE-D2 BIOS Setup

8 PC Health Status

■ Figure 8. PC Health Status

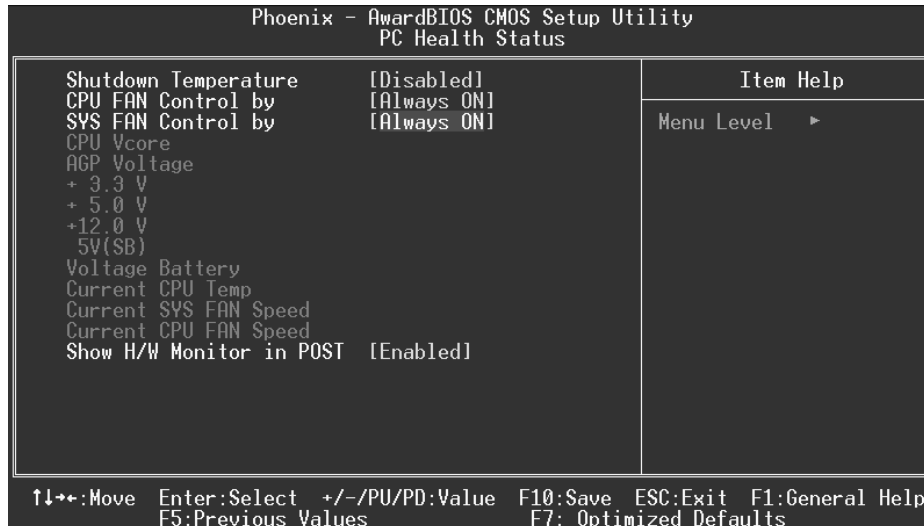

Shutdown Temperature

This item allows you to set up the CPU shutdown Temperature. This item only effective under Windows 98 ACPI mode.

The Choices: 60°C/140°F, 65°C/149°F, **Disabled** (default).

CPU FAN Control by (does not support on version 7.x)

The Choice “smart” can make your CPU FAN to reduce noise.

The Choices: Always On(default), smart.

SYS FANControl by (does not support on version 7.x)

The Choice “smart” can make your System FAN to reduce noise.

The Choices: Always On (default), smart.

CPU Vcore/ AGP Voltage/ +3.3V/ +5.0V/ +12V/ 5V (SB)/ Voltage Battery

Detect the system’s voltage status automatically.

P4TSE-D2 BIOS Setup

Current CPU Temp

Show you the current CPU temperature.

Current SYS FAN Speed

This field displays the current speed SYSTEM fan.

Current CPU FAN Speed

This field displays the current CPUFAN speed.

Show H/W Monitor in POST

If you computer contain a monitoring system, it will show PC health status during POST stage. The item offers several delay time to select you want.

The Choices: Enabled (default), Disabled .

P4TSE-D2 BIOS Setup

9 Frequency Control

■ Figure 9. Frequency Control



CPU Clock Ratio

The Choices: **8 X**(default), 9X, 10X, 11X, 12X, 13X, 14 X, 15X, 16X, 17X, 18X, 19X, 20 X, 21 X, 22 X, 23 X.

CPU Voltage (does not support on version 7.x)

This item allows you to select CPU Voltage Regulator.

The Choices: **Default** (default), +2.5%, +5.5%, +8.1%.

DIMM Voltage (does not support on version 7.x)

This item allows you to select DDR Voltage Regulator.

The Choices: **2.5V** (Default), 2.6V, 2.7V, 2.8V.

Auto Detect PCI Clk

This item allows you to enable / disable auto Detect PCI Clock.

The Choices: **Enabled** (default), Disabled.

Spread Spectrum

This item allows you to enable/disable the Spread Spectrum function.

The Choices: **Enabled** (default), Disabled.

P4TSE-D2 BIOS Setup

CPU Clock

This item allows you to select CPU Clock, and CPU over clocking.



If unfortunately, the system's frequency that you are selected is not functioning, there are two methods of booting-up the system.

Method 1: Clear the COMS data by setting the JCOMS1 ((2-3) closed)) as "ON" status. All the CMOS data will be loaded as defaults setting.

Method 2: Press the <Insert> key and Power button simultaneously, after that keep-on pressing the <Insert> key until the power-on screen showed. This action will boot-up the system according to FSB of the processor.

※ **It's strongly recommended to set CPU Vcore and clock in default setting. If the CPU Vcore and clock are not in default setting, it may cause CPU or M/B damage.**