

FCC Information and Copyright

This equipment has been tested and found to comply with the limits of a Class B digital device, pursuant to Part 15 of the FCC Rules. These limits are designed to provide reasonable protection against harmful interference in a residential installation. This equipment generates, uses and can radiate radio frequency energy and, if not installed and used in accordance with the instructions, may cause harmful interference to radio communications. There is no guarantee that interference will not occur in a particular installation.

The vendor makes no representations or warranties with respect to the contents here and specially disclaims any implied warranties of merchantability or fitness for any purpose. Further the vendor reserves the right to revise this publication and to make changes to the contents here without obligation to notify any party beforehand.

Duplication of this publication, in part or in whole, is not allowed without first obtaining the vendor's approval in writing.

The content of this user's manual is subject to be changed without notice and we will not be responsible for any mistakes found in this user's manual. All the brand and product names are trademarks of their respective companies.

TABLE OF CONTENTS

Chapter 1: Introduction 1

 1.1 P4 TPT with LAN Features..... 1

 1.2 Package Contents..... 3

 1.3 P4 TPT with LAN Layout (Version 7.5)..... 4

 1.4 Components of P4 TPT with LAN (Version 7.5)..... 5

Chapter 2: Hardware Installation..... 6

 2.1 Central Processing Unit (CPU)..... 6

 2.2 FAN Headers..... 7

 2.3 Memory Module Installation..... 8

 2.4 Connectors and Slots 9

Chapter 3: Headers & Jumpers Setup.....10

 3.1 How to Setup Jumpers.....10

 3.2 Detail Settings.....10

Chapter 4: Useful Help.....14

 4.1 Award BIOS Beep Code.....14

 4.2 Troubleshooting.....14

Chapter 5: WarpSpeederTM15

 5.1 Introduction.....15

 5.2 System Requirement.....15

 5.3 Installation.....16

CHAPTER 1: INTRODUCTION

1.1 P4 TPT WITH LAN FEATURES

A. Hardware

CPU

- Supports Socket 478.
- Supports Intel Pentium 4 Processor.
- Supports Intel Celeron/Celeron D Processor
- Supports Intel Pentium 4 478 Northwood/Prescott Processor up to 2.8GHz.
- Front side bus at 400/533/667/Fuzzy 800 MHz.

Chipset

- North Bridge: Intel 845PE.
- South Bridge: Intel ICH4.

Main Memory

- Supports up to 2 DDR devices.
- Supports:
 - FSB800 (Fuzzy): DDR400 (Maximum 2 single side type)
 - FSB667: DDR333 (Maximum 2 double/single side type)
 - FSB533: DDR333 (Maximum 2 double/single side type)
- Maximum memory size is 2GB.

DIMM Socket Location	DDR Module	Total Memory Size (MB)
DIMM1	64MB/128MB/256MB/512MB/1GB *1	Max is 2 GB.
DIMM2	64MB/128MB/256MB/512MB/1GB *1	

Super I/O

- Chip: ITE IT8712F
- Provides the most commonly used legacy Super I/O functionality.
- Environment Control initiatives:
 - H/W Monitor
 - ITE's "Smart Guardian" function.

Slots

- 5 32bit PCI bus master slots.
- 1 AGP 4X slot.

P4 TPT with LAN

Onboard IDE

- Support 4 IDE disk drives.
- Supports PIO mode 0~4, Bus Master, and Ultra DMA 33/66/100 function.

LAN

- Chip: RTL8100C
- Supports 10 Mb/s and 100 Mb/s auto-negotiation.
- Half/Full duplex capability.
- Supports personal Firewall setup.
- Supports ACPI power management.

Onboard AC'97 Sound Codec

- Chip: CMI9761A
- Compliant with AC'97 Version 2.3 specification for CMI9761A.
- Support 6 channels.
- Supports stereo MIC.

Rear (back) Side Connectors

- 1 parallel port.
- 1RJ-45 LAN jack.
- 1 Audio port.
- 1 PS/2 keyboard & mouse port.
- 2 Serial ports. (JCOM2 is optional).
- 4 USB 2.0 ports. (JUSB1 is optional.)

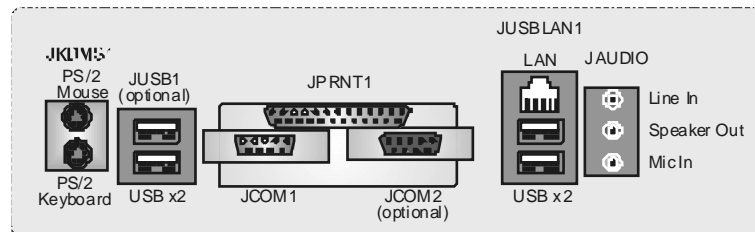

Front Side On-board Peripherals

- 2 IDE hard disk devices.
- 2 USB headers support 4 USB 2.0 ports. (JUSB4 is optional.)
- 1 CD-in connector.
- 1 Front Audio header.
- 1 Chassis open header.
- 1 S/PDIF out connector (optional).
- 1 Floppy port supports 2 FDD with 360K, 720K, 1.2M, 1.44M and 2.88Mbytes.

P4 TPT with LAN

Dimension

- ATX form Factor: 18.5cm (W) x 29.3cm (L)

B. BIOS & Software

BIOS

- Award legal BIOS.
- Supports APM1.2.
- Supports ACPI.
- Supports USB Function.

Software

- Supports 9th TouchTM, FlaserTM, BootblockerTM, WinFlasherTM, and WarpspeederTM.
- Offers the highest performance for Windows 98, Windows NT, Windows 2000, Windows ME, Windows XP, Linux, UNIX series, etc.

1.2 PACKAGE CONTENTS

- FDD Cable X 1
- HDD Cable X 1
- User's Manual X 1
- Fully Setup Driver CD X 1
- Rear I/O Panel for ATX Case X 1
- USB 2.0 Cable X1 (optional)
- S/PDIF Cable X 1 (optional)

P4 TPT with LAN

1.4 COMPONENTS OF P4 TPT WITH LAN (VERSION 7.5)

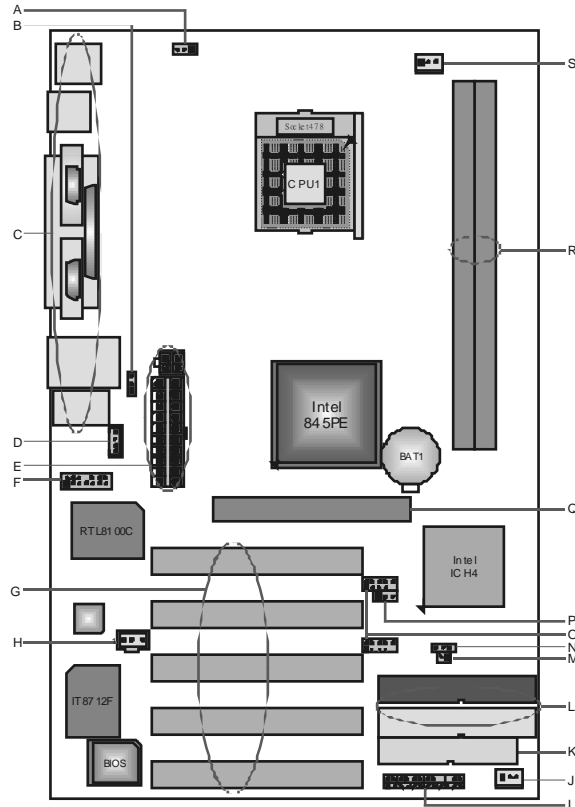

- | | |
|--|---|
| A. JKB_USBV1: Power source for JKBMS1 & JUSB1. (JUSB1 is optional.) | K. FDD1: Floppy disk connector. |
| B. JUSBV2: Power source for USB ports on JUSBLAN1. | L. IDE1/2: Hard disk connectors. |
| C. Back Panel Connectors (Rear Side). | M. JCI1: Case open Header (optional). |
| D. JCDIN1: CD-ROM audio-in header. | N. JCMOS1: Clear CMOS Header. |
| E. JATXPWR1/2: ATX power source. | O. JUSB3/4: Front USB headers (JUSB4 is optional). |
| F. JAUDIO1: Audio out header. | P. JUSBV3: Power source for JUSB3/4. |
| G. PCI1~5: Peripheral Component Interconnect slots. | Q. AGP1: Accelerated Graphics Port slot. |
| H. JSPDIF_OUT1: Digital audio out header (optional). | R. DDR1~2: DDR memory modules. |
| I. JPANEL1: Front panel connector. | S. JCFAN1: CUP fan connector. |
| J. JSFAN1: System fan connector. | |

CHAPTER 2: HARDWARE INSTALLATION

2.1 CENTRAL PROCESSING UNIT (CPU)

Step 1: Pull the lever sideways away from the socket and then raise the lever up to a 90-degree angle.

Step 2: Look for the white dot/cut edge. The white dot/cut edge should point wards the lever pivot. The CPU will fit only in the correct orientation.

Step 3: Hold the CPU down firmly, and then dose the lever to complete the installation.

Step 4: Put the CPU Fan on the CPU and buckle it. Connect the CPU FAN power cable to the JCFAN1. This completes the installation.

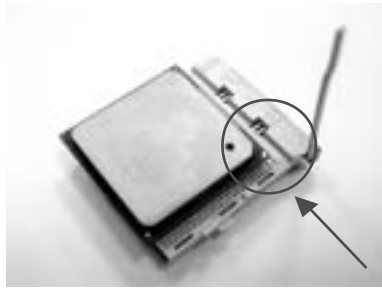

P4 TPT with LAN

2.2 FAN HEADERS

These fan headers support cooling fans built in the computer. The fan wiring and plug may be different according to the fan manufacturer. Connect the fan cable to the connector while matching the black wire to pin#1.

CPU FAN Header: JCFAN1

 JCFAN1	Pin	Assignment
	1	Ground
	2	+12V
	3	FAN RPM rate sense

System Fan Header: JSFAN1

 JSFAN1	Pin	Assignment
	1	Ground
	2	+12V
	3	FAN RPM rate sense

Note:

The JCFAN1 and JSFAN1 support 3-pin head connector. When connecting with wires onto connectors, please note that the red wire is the positive and should be connected to pin#2, and the black wire is Ground and should be connected to GND.

P4 TPT with LAN

2.3 MEMORY MODULE INSTALLATION

1. Unlock a DIMM slot by pressing the retaining clips outward. Align a DIMM on the slot such that the notch on the DIMM matches the break on the Slot.

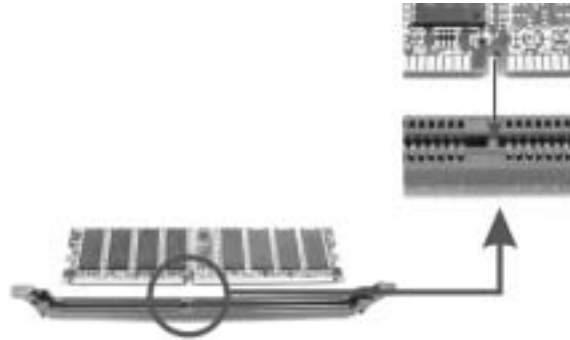

2. Insert the DIMM vertically and firmly into the slot until the retaining chip snap back in place and the DIMM is properly seated.

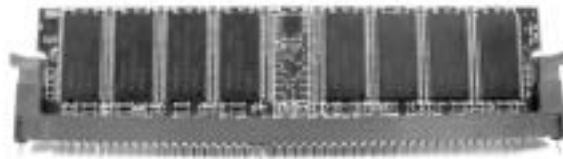

Note:

To assure the system safety, if you need to change DDR modules, firstly, please unplug the 20-pin power cable with the power connector, and then you can change the modules. Afterwards, plug in the cable the power connector again, and finally you can boot up the system.

P4 TPT with LAN

2.4 CONNECTORS AND SLOTS

Floppy Disk Connector: FDD1

The motherboard provides a standard floppy disk connector that supports 360K, 720K, 1.2M, 1.44M and 2.88M floppy disk types. This connector supports the provided floppy drive ribbon cables.

Hard Disk Connectors: IDE1/IDE2

The motherboard has a 32-bit Enhanced PCI IDE Controller that provides PIO Mode 0~5, Bus Master, and Ultra DMA 33/ 66/ 100 functionality. It has two HDD connectors IDE1 (primary) and IDE2 (secondary).

The IDE connectors can connect a master and a slave drive, so you can connect up to four hard disk drives. The first hard drive should always be connected to IDE1.

Peripheral Component Interconnect Slots: PCI 1~5

This motherboard is equipped with 5 standard PCI slots. PCI stands for Peripheral Component Interconnect, and it is a bus standard for expansion cards. This PCI slot is designated as 32 bits.

Accelerated Graphics Port Slot: AGP1

Your monitor will attach directly to that video card. This motherboard supports video cards for PCI slots, but it is also equipped with an Accelerated Graphics Port (AGP). An AGP card will take advantage of AGP technology for improved video efficiency and performance, especially with 3D graphics.

CHAPTER 3: HEADERS & JUMPERS SETUP



3.1 HOW TO SETUP JUMPERS

The illustration shows how to set up jumpers. When the jumper cap is placed on pins, the jumper is “close”, if not, that means the jumper is “open”.





3.2 DETAIL SETTINGS

JKB_USBV1: Power Source Selection Header for JKBMS1 & JUSB2

JKB_USBV1	Assignment	Description
 1 Pin 1-2 close (Default)	+5V	+5V for PS/2 keyboard/ mouse and USB at the JUSB1 connector port.
 1 Pin 2-3 close	+5V Standby Voltage	PS/2 keyboard /mouse and USB at the JUSB1 at the JUSB1 connector port are powered with +5V standby voltage.

JUSBV2/JUSBV3: Power Source Selection Header for JUSBLAN1 & JUSB3/JUSB4

JUSBV2/JUSBV3	Assignment	Description
1  Pin 1-2 close (Default)	+5V	JUSBV2: +5V for USB at the JUSBLAN1 connector port. JUSBV3: +5V for JUSB3/JUSB4.
1  Pin 2-3 close	+5V standby Voltage	JUSBV2: USB port at JUSBLAN1 is powered with standby voltage of 5V. JUSBV3: JUSB3/4 ports powered with standby voltage of 5V.

Note:

In order to support this function “Power-o system via USB device,” “JUSBV2 /JUSBV3” jumper cap should be placed on Pin 2-3 individually.

P4 TPT with LAN

JUSB3/JUSB4 Front USB Header (JUSB4 is optional.)



This header allows user to connect additional USB cable on the PC front panel, and also can be connected with internal USB devices, like USB card reader.

 <p>JUSB3/JUSB4</p>	Pin	Assignment	Pin	Assignment
	1	+5V (f used)	2	+5V (f used)
	3	USB-	4	USB-
	5	USB+	6	USB+
	7	Ground	8	Ground
	9	Key	10	NC

JATXPWR1/JATXPWR2: Power Source Connectors

JATXPWR1: This connector allows user to connect 20-pin power connector on the ATX power supply.

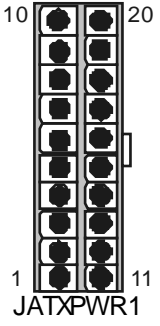
JATXPWR2: By connecting this connector, it will provide +12V to CPU power circuit.

 <p>JATXPWR1</p>	Pin	Assignment	Pin	Assignment
	1	+3.3V	11	+3.3V
	2	+3.3V	12	-12V
	3	Ground	13	Ground
	4	+5V	14	PS_ON
	5	Ground	15	Ground
	6	+5V	16	Ground
	7	Ground	17	Ground
	8	PW_OK	18	-5V
	9	Standby Voltage +5V	19	+5V
	10	+12V	20	+5V
 <p>JATXPWR2</p>	Pin	Assignment	Pin	Assignment
	1	+12V	3	Ground
	2	+12V	4	Ground

JCDIN1: CD-ROM Audio-in Connector

This connector allows user to connect the audio source from the variety devices, like CD-ROM, DVD-ROM, PCI sound card, PCI TV turner card etc..

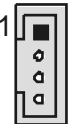
 <p>JCDIN1</p>	Pin	Assignment
	1	Left channel input
	2	Ground
	3	Ground
	4	Right channel input

P4 TPT with LAN

JSPDIF_OUT1: Digital Audio Connector (optional)

This connector allows user to connect the PCI bracket SPDIF output header.

 JSPDIF_OUT1	Pin	Assignment
	1	+5V
	2	SPDIF_OUT
	3	Ground

JCL1: Case Open Header

This connector allows system to monitor PC case open status. If the signal has been triggered, it will record to the CMOS and show the message on next boot-up.

 JCL1	Pin	Assignment
	1	Case open signal
	2	Ground

JAUDIO1: Front Panel Audio Header

This header allows user to connect the front audio out put cable with the PC front panel. It will disable the output on back panel audio connectors.

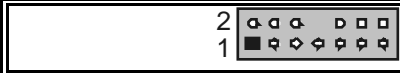
 JAUDIO1			
Pin	Assignment	Pin	Assignment
1	Mic in/center	2	Ground
3	Mic power/Bass	4	Audio power
5	Right line out/Speaker out Right	6	Right line out/Speaker out Right
7	Reserved	8	Key
9	Left line out/Speaker out Left	10	Left line out/Speaker out Left
11	Right line in/Rear speaker Right	12	Right line in/Rear speaker Right
13	Left line in/Rear speaker Left	14	Left line in/Rear speaker Left

P4 TPT with LAN



JPANEL1: Front Panel Header

This 24-pin connector includes Power-on, Reset, HDD LED, Power LED, Sleep button, speaker and IrDA Connection. It allows user to connect the PC case's front panel switch functions.

2	1	24	23	JPANEL1	
Pin	Assignment	Function	Pin	Assignment	Function
1	+5V	Speaker Connector	2	Sleep control	Sleep button
3	N/A		4	Ground	
5	N/A		6	N/A	N/A
7	Speaker	Hard drive LED	8	Power LED (+)	Power LED
9	HDD LED (+)		10	Power LED (+)	
11	HEE LED (-)		12	Power LED (-)	
13	Ground	Reset button	14	Power button	Power-on button
15	Reset control		16	Ground	
17	N/A		18	Key	
19	N/A	IrDA Connector	20	Key	IrDA Connector
21	+5V		22	Ground	
23	IRTX		24	IRRX	

JCMOS1: Close CMOS Header

By placing the jumper on pin2-3, it allows user to restore the BIOS safe setting and the CMOS data, please carefully follow the procedures to avoid damaging the motherboard.

JCMOS1	Assignment
 Pin 1-2 close	Normal Operation (Default).
 Pin 2-3 close	Clear CMOS data.

※ Clear CMOS Procedures:

1. Remove AC power line.
2. Set the jumper to "Pin 2-3 dose".
3. Wait for five seconds.
4. Set the jumper to "Pin 1-2 dose".
5. Power on the AC.
6. Reset your desired password or clear the CMOS data.

CHAPTER 4: USEFUL HELP

4.1 AWARD BIOS BEEP CODE

Beep	Meaning
One long beep followed by two short beeps	Video card not found or video card memory bad
High-low siren sound	CPU overheated, system will shut down automatically
One Short beep when system boot-up	No error found during POST
Long beeps every other second	No DRAM detected or install

4.2 TROUBLESHOOTING

Probable	Solution
1. No power to the system at all Power light don't illuminate, fan inside power supply does not turn on. 2. Indicator light on key board does not turn on.	1. Make sure power cable is securely plugged in. 2. Replace cable. 3. Contact technical support.
System inoperative. Keyboard lights are on, power indicator lights are lit, and hard drive is spinning.	Using even pressure on both ends of the DIMM, press down firmly until the module snaps into place.
System does not boot from hard disk drive, can be booted from CD-ROM drive.	1. Check cable running from disk to disk controller board. Make sure both ends are securely plugged in; check the drive type in the standard CMOS setup. 2. Backing up the hard drive is extremely important. All hard disks are capable of breaking down at any time.
System only boots from CD-ROM. Hard disk can be read and applications can be used but booting from hard disk is impossible.	Back up data and applications files. Reformat the hard drive. Re-install applications and data using backup disks.
Screen message says "Invalid Configuration" or "CMOS Failure."	Review system's equipment. Make sure correct information is in setup.
Cannot boot system after installing second hard drive.	Set master/slave jumpers correctly. Run SETUP program and select correct drive types. Call the drive manufacturers for compatibility with other drives.

CHAPTER 5: WARPSPEEDER™



5.1 INTRODUCTION

[WarpSpeeder™], a new powerful control utility, features three user-friendly functions including Overclock Manager, Overvoltage Manager, and Hardware Monitor.

With the Overdock Manager, users can easily adjust the frequency they prefer or they can get the best CPU performance with just one click. The Overvoltage Manager, on the other hand, helps to power up CPU core voltage and Memory voltage. The cool Hardware Monitor smartly indicates the temperatures, voltage and CPU fan speed as well as the chipset information. Also, in the About panel, you can get detail descriptions about BIOS model and chipsets. In addition, the frequency status of CPU, memory, AGP and PCI along with the CPU speed are synchronically shown on our main panel.

Moreover, to protect users' computer systems if the setting is not appropriate when testing and results in system fail or hang, [WarpSpeeder™] technology assures the system stability by automatically rebooting the computer and then restart to a speed that is either the original system speed or a suitable one.

5.2 SYSTEM REQUIREMENT

OS Support: Windows 98 SE, Windows Me, Windows 2000, Windows XP
DirectX: DirectX 8.1 or above. (The Windows XP operating system includes DirectX 8.1. If you use Windows XP, you do not need to install DirectX 8.1.)

P4 TPT with LAN

5.3 *INSTALLATION*

1. Execute the setup execution file, and then the following dialog will pop up. Please click “Next” button and follow the default procedure to install.



2. When you see the following dialog in setup procedure, it means setup is completed. If the “Launch the WarpSpeeder Tray Utility” checkbox is checked, the Tray Icon utility and [WarpSpeeder™] utility will be automatically and immediately launched after you click “Finish” button.



P4 TPT with LAN

Usage:

The following figures are just only for reference, the screen printed in this user manual will change according to your motherboard on hand.

[WarpSpeeder™] includes 1 tray icon and 5 panels:

1. Tray Icon:

Whenever the Tray Icon utility is launched, it will display a little tray icon on the right side of Windows Taskbar.



This utility is responsible for conveniently invoking [WarpSpeeder™] Utility. You can use the mouse by clicking the left button in order to invoke [WarpSpeeder™] directly from the little tray icon or you can right-click the little tray icon to pop up a popup menu as following figure. The "Launch Utility" item in the popup menu has the same function as mouse left-click on tray icon and "Exit" item will close Tray Icon utility if selected.



2. Main Panel

If you click the tray icon, [WarpSpeeder™] utility will be invoked. Please refer to the following figure; the utility's first window you will see is Main Panel.

Main Panel contains features as follows:

- a. Display the CPU Speed, CPU external clock, Memory dock, AGP dock, and PCI dock information.
- b. Contains About, Voltage, Overclock, and Hardware Monitor Buttons for invoking respective panels.
- c. With a user-friendly Status Animation, it can represent 3 overclock percentage stages:

P4 TPT with LAN

Man walking → overdock percentage from 100% ~ 110 %

Panther running → overclock percentage from 110% ~ 120%

Car racing → overclock percentage from 120% ~ above

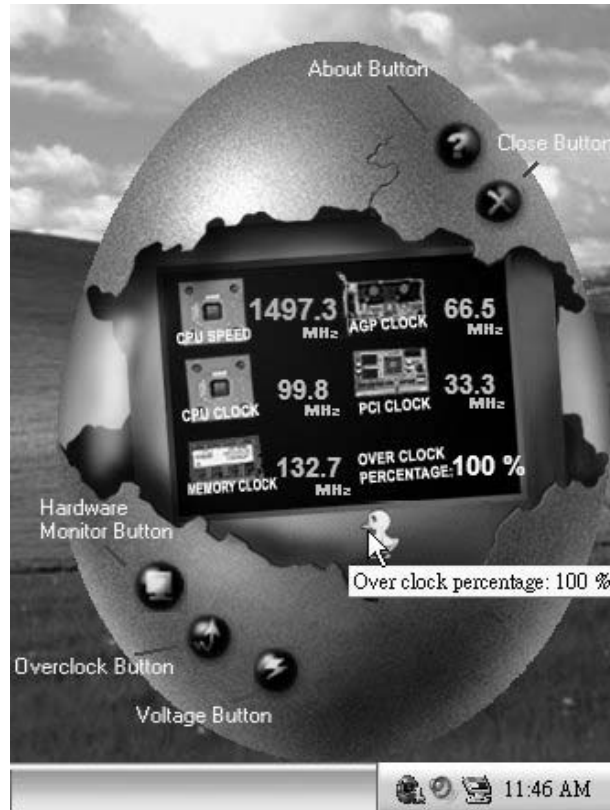

P4 TPT with LAN

3. Voltage Panel

Click the Voltage button in Main Panel, the button will be highlighted and the Voltage Panel will slide out to up as the following figure.

In this panel, you can decide to increase CPU core voltage and Memory voltage or not. The default setting is "No". If you want to get the best performance of overclocking, we recommend you click the option "Yes".



P4 TPT with LAN

4. Overclock Panel

Click the Overclock button in Main Panel, the button will be highlighted and the Overdock Panel will slide out to left as the following figure.



Overclock Panel contains the these features:

- “-3MHz button”, “-1MHz button”, “+1MHz button”, and “+3MHz button”: provide user the ability to do real-time overclock adjustment.

Warning:

Manually overclock is potentially dangerous, especially when the overclocking percentage is over 110 %. We strongly recommend you verify every speed you overclock by click the Verify button. Or, you can just click Auto overclock button and let [WarpSpeeder™] automatically gets the best result for you.

- “Recovery Dialog button”: Pop up the following dialog. Let user select a restoring way if system need to do a fail-safe reboot.

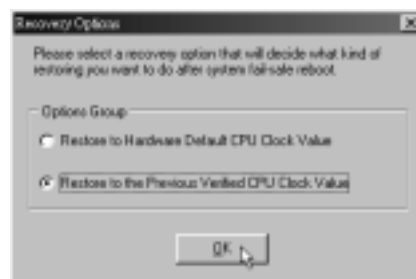

P4 TPT with LAN

- c. "Auto-overclock button": User can click this button and [WarpSpeeder™] will set the best and stable performance and frequency automatically. [WarpSpeeder™] utility will execute a series of testing until system fail. Then system will do fail-safe reboot by using Watchdog function. After reboot, the [WarpSpeeder™] utility will restore to the hardware default setting or load the verified best and stable frequency according to the Recovery Dialog's setting.
- d. "Verify button": User can click this button and [WarpSpeeder™] will proceed a testing for current frequency. If the testing is ok, then the current frequency will be saved into system registry. If the testing fail, system will do a fail-safe rebooting. After reboot, the [WarpSpeeder™] utility will restore to the hardware default setting or load the verified best and stable frequency according to the Recovery Dialog's setting.

Note:

Because the testing programs, invoked in Auto-overclock and Verify, include DirectDraw, Direct3D and DirectShow tests, the DirectX 8.1 or newer runtime library is required. And please make sure our display card's color depth is High color (16 bit) or True color (24/32 bit) that is required for Direct3D rendering.

5. Hardware Monitor Panel

Click the Hardware Monitor button in Main Panel, the button will be highlighted and the Hardware Monitor panel will slide out to left as the following figure.

In this panel, you can get the real-time status information of your system. The information will be refreshed every 1 second.



P4 TPT with LAN

6. About Panel

Click the “about” button in Main Panel, the button will be highlighted and the About Panel will slide out to up as the following figure.

In this panel, you can get model name and detail information in hints of all the chipset that are related to overclocking. You can also get the mainboard’s BIOS model and the Version number of [WarpSpeeder™] utility.

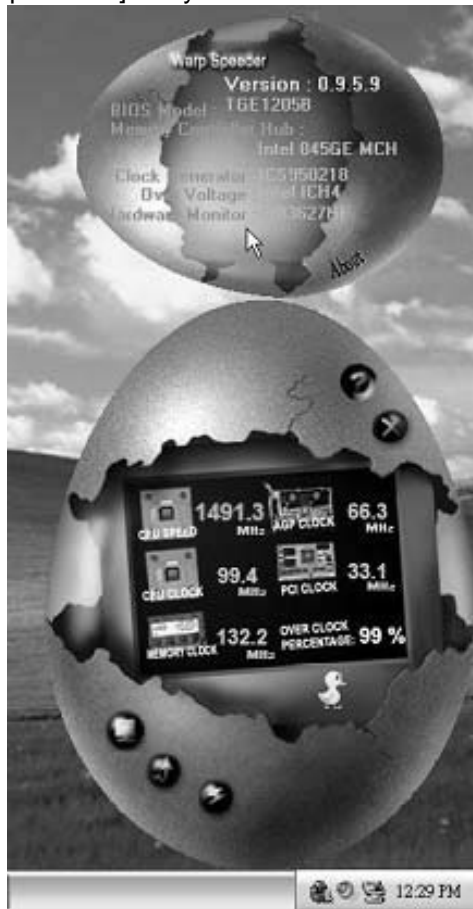

Note:

Because the overclock, overvoltage, and hardware monitor features are controlled by several separate chipset, [WarpSpeeder™] divide these features to separate panels. If one chipset is not on board, the correlative button in Main panel will be disabled, but will not interfere other panels' functions. This property can make [WarpSpeeder™] utility more robust.

P4 TPT with LAN

7/30, 2004

P4TPT
BIOS Setup

BIOS Setup	1
1 Main Menu.....	3
2 Standard CMOS Features	7
3 Advanced BIOS Features.....	10
4 Advanced Chipset Features	14
5 Integrated Peripherals	17
6 Power Management Setup	21
7 PnP/PCI Configurations.....	26
8 PC Health Status	28
9 Frequency Control	29

BIOS Setup

Introduction

This manual discussed Award™ Setup program built into the ROM BIOS. The Setup program allows users to modify the basic system configuration. This special information is then stored in battery-backed RAM so that it retains the Setup information when the power is turned off.

The Award BIOS™ installed in your computer system's ROM (Read Only Memory) is a custom version of an industry standard BIOS. This means that it supports Intel Pentium® 4 processor input/output system. The BIOS provides critical low-level support for standard devices such as disk drives and serial and parallel ports.

Adding important has customized the Award BIOS™, but nonstandard, features such as virus and password protection as well as special support for detailed fine-tuning of the chipset controlling the entire system.

The rest of this manual is intended to guide you through the process of configuring your system using Setup.

Plug and Play Support

These AWARD BIOS supports the Plug and Play Version 1.0A specification. ESCD (Extended System Configuration Data) write is supported.

EPA Green PC Support

This AWARD BIOS supports Version 1.03 of the EPA Green PC specification.

APM Support

These AWARD BIOS supports Version 1.1&1.2 of the Advanced Power Management (APM) specification. Power management features are implemented via the System Management Interrupt (SMI). Sleep and Suspend power management modes are supported. This AWARD BIOS can manage power to the hard disk drives and video monitors .

ACPI Support

Award ACPI BIOS support Version 1.0 of Advanced Configuration and Power interface specification (ACPI). It provides ASL code for power management and device configuration capabilities as defined in the ACPI specification, developed by Microsoft, Intel and Toshiba.

P4TPT BIOS Manual

PCI Bus Support

This AWARD BIOS also supports Version 2.1 of the Intel PCI (Peripheral Component Interconnect) local bus specification.

DRAM Support

DDR DRAM (Double Data Rate Synchronous DRAM) are supported.

Supported CPUs

This AWARD BIOS supports the Intel Pentium[®] 4 CPU.

Using Setup

In general, you use the arrow keys to highlight items, press <Enter> to select, use the <PgUp> and <PgDn> keys to change entries, press <F1> for help and press <Esc> to quit. The following table provides more detail about how to navigate in the Setup program by using the keyboard.

Keystroke	Function
Up arrow	Move to previous item
Down arrow	Move to next item
Left arrow	Move to the item on the left (menu bar)
Right arrow	Move to the item on the right (menu bar)
Move Enter	Move to the item you desired
PgUp key	Increase the numeric value or make changes
PgDn key	Decrease the numeric value or make changes
+ Key	Increase the numeric value or make changes
- Key	Decrease the numeric value or make changes
Esc key	Main Menu – Quit and not save changes into CMOS Status Page Setup Menu and Option Page Setup Menu – Exit Current page and return to Main Menu
F1 key	General help on Setup navigation keys
F5 key	Load previous values from CMOS
F6 key	Load the fail-safe defaults from BIOS default table
F7 key	Load the optimized defaults
F9 key	Open menu in BIOS.
F10 key	Save all the CMOS changes and exit

1 Main Menu

Once you enter Award BIOS™ CMOS Setup Utility, the Main Menu will appear on the screen. The Main Menu allows you to select from several setup functions. Use the arrow keys to select among the items and press <Enter> to accept and enter the sub-menu.

!! WARNING !!

The information about BIOS defaults on manual (**Figure 1,2,3,4,5,6,7,8,9**) is just for reference; please refer to the BIOS installed on board, for update information.

■ **Figure 1. Main Menu**

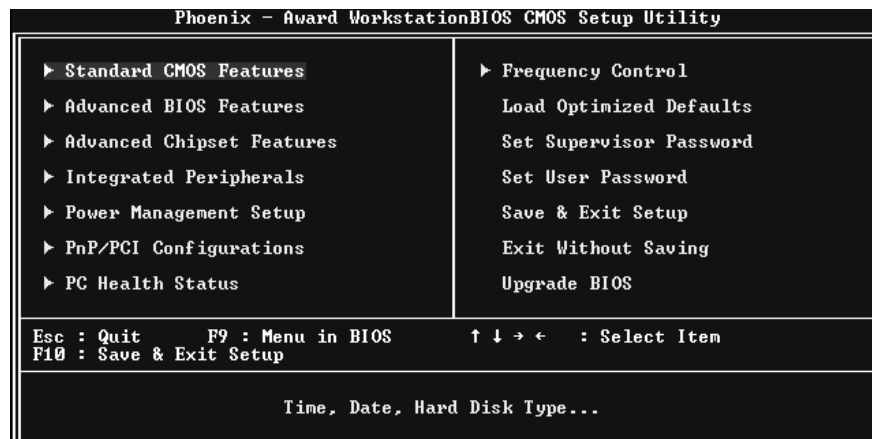

Standard CMOS Features

This submenu contains industry standard configurable options.

Advanced BIOS Features

This submenu allows you to configure enhanced features of the BIOS.

Advanced Chipset Features

This submenu allows you to configure special chipset features.

Integrated Peripherals

This submenu allows you to configure certain IDE hard drive options and Programmed Input/ Output features.

Power Management Setup

This submenu allows you to configure the power management features.

P4TPT BIOS Manual

PnP/PCI Configurations

This submenu allows you to configure certain “Plug and Play” and PCI options.

PC Health Status

This submenu allows you to monitor the hardware of your system.

Frequency Control

This submenu allows you to change CPU Vcore Voltage and CPU/PCI clock. **(However, this function is strongly recommended not to use. Not properly change the voltage and clock may cause CPU or M/B damage!)**

Load Optimized Defaults

This selection allows you to reload the BIOS when the system is having problems particularly with the boot sequence. These configurations are factory settings optimized for this system. A confirmation message will be displayed before defaults are set.



Load Optimized Defaults (Y/N)? N

Set Supervisor Password

Setting the supervisor password will prohibit everyone except the supervisor from making changes using the CMOS Setup Utility. You will be prompted with to enter a password.



Enter Password:

Set User Password

If the Supervisor Password is not set, then the User Password will function in the same way as the Supervisor Password. If the Supervisor Password is set and the User Password is set, the “User” will only be able to view configurations but will not be able to change them.



Enter Password:

P4TPT BIOS Manual

Save & Exit Setup

Save all configuration changes to CMOS(memory) and exit setup. Confirmation message will be displayed before proceeding.

```
SAVE to CMOS and EXIT (Y/N)? Y
```

Exit Without Saving

Abandon all changes made during the current session and exit setup. Confirmation message will be displayed before proceeding.

```
Quit Without Saving (Y/N)? N
```

Upgrade BIOS

This submenu allows you to upgrade bios.

```
BIOS UPDATE UTILITY (Y/N)? N
```

P4TPT BIOS Manual

2 Standard CMOS Features

The items in Standard CMOS Setup Menu are divided into 10 categories. Each category includes no, one or more than one setup items. Use the arrow keys to highlight the item and then use the <PgUp> or <PgDn> keys to select the value you want in each item.

■ Figure 2. Standard CMOS Setup

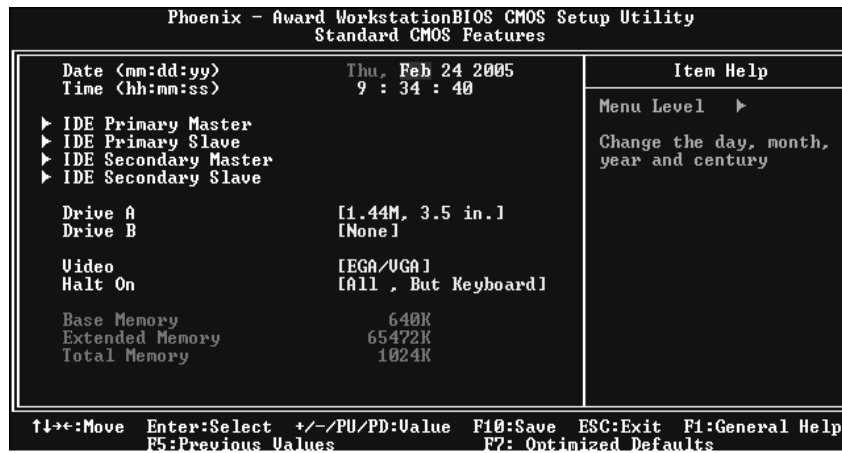

P4TPT BIOS Manual

Main Menu Selections

This table shows the selections that you can make on the Main Menu.

Item	Options	Description
Date	mm : dd : yy	Set the system date. Note that the 'Day' automatically changes when you set the date.
Time	hh : mm : ss	Set the system internal clock.
IDE Primary Master	Options are in its sub menu.	Press <Enter> to enter the sub menu of detailed options
IDE Primary Slave	Options are in its sub menu.	Press <Enter> to enter the sub menu of detailed options.
IDE Secondary Master	Options are in its sub menu.	Press <Enter> to enter the sub menu of detailed options.
IDE Secondary Slave	Options are in its sub menu.	Press <Enter> to enter the sub menu of detailed options.
Drive A Drive B	360K, 5.25 in 1.2M, 5.25 in 720K, 3.5 in 1.44M, 3.5 in 2.88M, 3.5 in None	Select the type of floppy disk drive installed in your system.
Video	EGA/VGA CGA 40 CGA 80 MONO	Select the default video device.

P4TPT BIOS Manual

Item	Options	Description
Halt On	All Errors No Errors All, but Keyboard All, but Diskette All, but Disk/ Key	Select the situation in which you want the BIOS to stop the POST process and notify you.
Base Memory	N/A	Displays the amount of conventional memory detected during boot up.
Extended Memory	N/A	Displays the amount of extended memory detected during boot up.
Total Memory	N/A	Displays the total memory available in the system.

3 Advanced BIOS Features

■ Figure 3. Advanced BIOS Setup

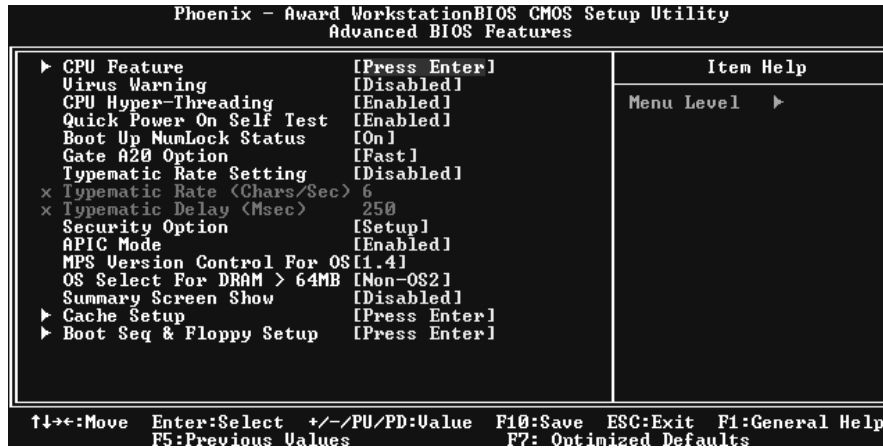

CPU Feature

This allows you to choose CPU related settings.

Thermal Management

Allow you to choose the thermal management method of your monitor.

The Choices: Thermal Monitor 1 (default), Thermal Monitor2.

Notes: The choices will be different according to your CPU features.

TM2 Bus Ratio

Represents the frequency. Bus ratio of the throttled performance state that will be initiated when the on-die sensor goes from not hot to hot.

The Choices: 0X (default).

TM2 Bus VID

Represents the voltage of the throttled performance state that will be initiated when the on-die sensor goes from not hot to hot.

The Choices: 0.8375 (default).

Limit CPU ID Max Val

Set limit CPU ID maximum vale to 3, it should be disabled for Win XP.

The Choices: Disabled (default), Enabled.]

P4TPT BIOS Manual

Virus Warning

This option allows you to choose the Virus Warning feature that is used to protect the IDE Hard Disk boot sector. If this function is enabled and an attempt is made to write to the boot sector, BIOS will display a warning message on the screen and sound an alarm beep.

Enabled	Virus protection is activated.
Disabled (default)	Virus protection is disabled.

CPU Hyper-Threading

This option allows you to enable or disabled CPU Hyper-Threading.

The Choices: **Enabled** (Default), Disabled.

Quick Power On Self Test

Enabling this option will cause an abridged version of the Power On Self-Test (POST) to execute after you power up the computer.

Disabled	Normal POST.
Enabled (default)	Enable quick POST.

Boot Up NumLock Status

Selects the NumLock. State after power on.

On (default)	Numpad works as number keys.
Off	Numpad works as arrow keys.

Gate A20 Option

Select if chipset or keyboard controller should control Gate A20.

Normal	A pin in the keyboard controller controls Gate A20.
Fast (default)	Lets chipset control Gate A20.

Typematic Rate Setting

When a key is held down, the keystroke will repeat at a rate determined by the keyboard controller. When enabled, the typematic rate and typematic delay can be configured.

The Choices: **Disabled** (default), Enabled.

Typematic Rate (Chars/Sec)

Sets the rate at which a keystroke is repeated when you hold the key down.

The Choices: **6** (default), 8,10,12,15,20,24,30.

Typematic Delay (Msec)

Sets the delay time after the key is held down before it begins to repeat the keystroke.

The Choices: **250** (default), 500,750,1000.

Security Option

This option will enable only individuals with passwords to bring the system online and/or to use the CMOS Setup Utility.

P4TPT BIOS Manual

System	A password is required for the system to boot and is also required to access the Setup Utility.
Setup (default)	A password is required to access the Setup Utility only.

This will only apply if passwords are set from the Setup main menu.

APIC Mode

Selecting Enabled enables ACPI device mode reporting from the BIOS to the operating system.

The Choices: Enabled (default), Disabled.

MPS Version Control For OS

The BIOS supports version 1.1 and 1.4 of the Intel multiprocessor specification. Select version supported by the operation system running on this computer.

The Choices: 1.4 (default), 1.1.

OS Select For DRAM > 64MB

A choice other than Non-OS2 is only used for OS2 systems with memory exceeding 64MB.

The Choices: Non-OS2 (default), OS2.

Summary Screen Show

This item allows you to enable/disable the summary screen. Summary screen means system configuration and PCI device listing.

The choices: Enabled, Disabled (default).

Cache Setup

CPU L3 Cache

Depending on the CPU/chipset in use, you may be able to increase memory access time with this option.

Enabled (default)	Enable cache.
Disabled	Disable cache.

Boot Seq & Floppy Setup

First/ Second/ Third/ Boot Other Device

These BIOS attempt to load the operating system from the device in the sequence selected in these items.

The Choices: Floppy, LS120, HDD-0, SCSI, CDROM, HDD-1, HDD-2, HDD-3, ZIP100, LAN, HPT370, Disabled.

Swap Floppy Drive

For systems with two floppy drives, this option allows you to swap logical drive assignments.

The Choices: Disabled (default), Enabled.

P4TPT BIOS Manual

Boot Up Floppy Seek

Enabling this option will test the floppy drives to determine if they have 40 or 80 tracks. Disabling this option reduces the time it takes to boot-up.

The Choices: Disabled, **Enabled** (default).

4 Advanced Chipset Features

This submenu allows you to configure the specific features of the chipset installed on your system. This chipset manage bus speeds and access to system memory resources, such as DRAM and external cache. It also coordinates communications with the PCI bus. The default settings that came with your system have been optimized and therefore should not be changed unless you are suspicious that the settings have been changed incorrectly.

■ Figure 4. Advanced Chipset Setup



DRAM Timing Selectable

When synchronous DRAM is installed, the number of clock cycles of CAS latency depends on the DRAM timing.

The Choices: By SPD (default), Manual.

CAS Latency Time

When synchronous DRAM is installed, the number of clock cycles of CAS latency depends on the DRAM timing.

The Choices: 1.5 (default), 2, 2.5, 3

Active to Precharge Delay

This item controls the number of DRAM clocks to activate the precharge delay.

The Choices: 7 (default), 6, 5.

P4TPT BIOS Manual

DRAM RAS# to CAS# Delay

This field let you insert a timing delay between the CAS and RAS strobe signals, used when DRAM is written to, read from, or refreshed. Fast gives faster performance; and slow gives more stable performance. This field applies only when synchronous DRAM is installed in the system.

The Choices: 3 (default), 2.

DRAM RAS# Precharge

If an insufficient number of cycle is allowed for RAS to accumulate its charge before DRAM refresh, the refresh may be incomplete, and the DRAM may fail to retain data. Fast gives faster performance; and Slow gives more stable performance. This field applies only when synchronous DRAM is installed in the system.

The Choices: 3 (default), 2.

Turbo Mode

This option allows you to enable or disable Turbo Mode.

The Choices: Disabled (Default) , Enabled.

Memory Frequency For

This item allows you to select the Memory Frequency.

The Choices: Auto (default), PC100, PC133.

System BIOS Cacheable

Selecting Enabled allows you caching of the system BIOS ROM at F0000h~FFFFh, resulting a better system performance. However, if any program writes to this memory area, a system error may result.

The Choices: Enabled (default), Disabled.

Video BIOS Cacheable

Select Enabled allows caching of the video BIOS, resulting a better system performance. However, if any program writes to this memory area, a system error may result.

The Choices: Disabled (default), Enabled.

Video RAM Cacheable

This option allows you to enable or disable VGA RAM cache capability.

The Choices: Disabled (Default), Enabled

Memory Hole At 15M-16M

You can reserve this area of system memory for ISA adapter ROM. When this area is reserved it cannot be cached. The user information of peripherals that need to use this area of system memory usually2 discussed their memory requirements.

The Choices: Disabled (default), Enabled.

P4TPT BIOS Manual

Delayed Transaction

The chipset has an embedded 32-bit posted write buffer to support delay transactions cycles. Select Enabled to support compliance with PCI specification version 2.1.

The Choices: Enabled (default), Disabled.

AGP Aperture Size (MB)

Select the size of the Accelerated Graphics Port (AGP) aperture. The aperture is a portion of the PCI memory address range dedicated for graphics memory address space. Host cycles that hit the aperture range are forwarded to the AGP without any translation.

The Choices: 64 (default), 4, 8, 16, 32, 128, 256.

5 Integrated Peripherals

■ Figure 5. Integrated Peripherals

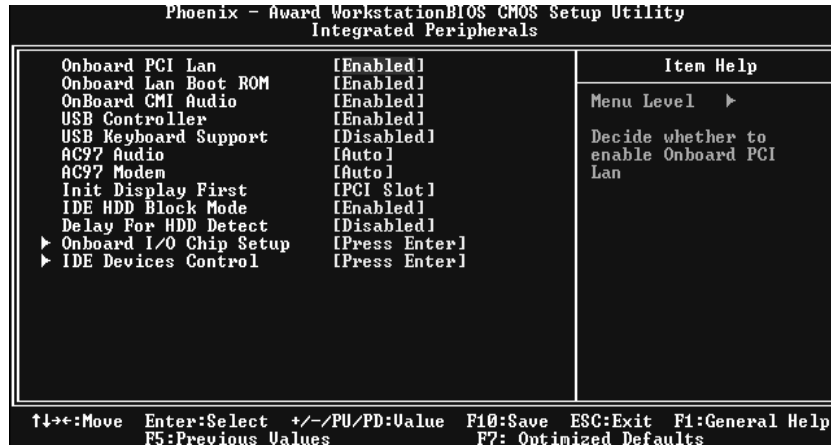

Onboard PCI LAN

This item allows you to enable or disable the Onboard PCI LAN controller.

The Choices: Enabled (default), Disabled.

Onboard LAN Boot ROM

This item allows you to enable or disable the Onboard LAN Boot ROM controller.

The Choices: Enabled (default), Disabled.

Onboard CMI Audio

This item allows you to enable or disabled the onboard CMI 8738 Audio Chip.

The Choices: Enabled (Default), Disabled.

USB Controller

Select Enabled if your system contains a Universal Serial Bus (USB) controller and you have USB peripherals.

The Choices: Enabled (default), Disabled.

USB Keyboard Support

The default value is disabled.

Enabled

Enable USB Keyboard Support.

Disabled (default)

Disable USB Keyboard Support.

P4TPT BIOS Manual

AC97 Audio/ Modem

This item allows you to decide to enable/ disable to support AC97 Audio/Modem.

The Choices: Auto (default), Disabled.

Init Display First

This item allows you to decide to active whether PCI Slot or on-chip VGA first.

The Choices: PCI Slot (default), AGP.

IDE HDD Block Mode

Block mode is also called block transfer, multiple commands, or multiple sector read / write. If your IDE hard drive supports block mode (most new drives do), select Enabled for automatic detection of the optimal number of block mode (most new drives do), select Enabled for automatic detection of the optimal number of block read / write per sector where the drive can support.

The Choices: Enabled (default), Disabled.

Delay For HDD Detect

Some old hard disk drive need much time to wait it ready, if your hard disk drive can not been detected try to set this item to enable.

The Choices: Disabled (Default), Enabled.

Onboard I/O Chip Setup

Press Enter to configure Super IO device.

Onboard FDC Controller

Select Enabled if your system has a floppy disk controller (FDC) installed on the system board and you wish to use it. If install and FDC or the system has no floppy drive, select Disabled in this field.

The Choices: Enabled (default), Disabled.

Onboard Serial Port 1

Select an address and corresponding interrupt for the first and second serial ports.

The Choices: 3F8/IRQ4 (default), Disabled, Auto, 2F8/IRQ3, 3E8/IRQ4, 2E8/IRQ3.

Onboard Serial Port 2

Select an address and corresponding interrupt for the first and second serial ports

The Choices: 2F8/IRQ3 (default), Disabled, Auto, 3F8/IRQ4, 3E8/IRQ4, 2E8/IRQ3.

P4TPT BIOS Manual

UART Mode Select

This item allows you to determine which Infrared (IR) function of onboard I/O chip.

The Choices: Normal (default), ASKIR, IrDA, SCR.

UR2 Duplex Mode

Select the value required by the IR device connected to the IR port. Full-duplex mode permits simultaneous two-direction transmission. Half-duplex mode permits transmission in one direction only at a time.

The Choices: Half (default), Full.

Onboard Parallel Port

This item allows you to determine access onboard parallel port controller with which I/O Address.

The Choices: 378/IRQ7 (default), 278/IRQ5, 3BC/IRQ7, Disabled.

Parallel Port Mode

The default value is SPP.

SPP (default)	Using Parallel Port as Standard Printer Port.
EPP	Using Parallel Port as Enhanced Parallel Port.
ECP	Using Parallel Port as Extended Capabilities Port.
ECP+EPP	Using Parallel Port as ECP & EPP mode.

ECP Mode Use DMA

Select a DMA Channel for the port.

The Choices: 3 (default), 1.

Game Port Address

Game Port I/O Address.

The Choices: 201 (default), 209, Disabled.

Midi Port Address

Midi Port Base I/O Address.

The Choices: 330 (default), 300, Disabled.

Midi Port IRQ

This determines the IRQ in which the Midi Port can use.

The Choices: 10 (default), 5.

P4TPT BIOS Manual

IDE Devices Control

Press Enter to configure the onboard IDE Controllers.

On-Chip Primary/ Secondary PCI IDE

This item allows you to enable or disable the primary/ secondary IDE Channel.

The Choices: Enabled (Default), Disabled.

Primary / Secondary /Master / Slave PIO

The IDE PIO (Programmed Input / Output) fields let you set a PIO mode (0-4) for each of the IDE devices that the onboard IDE interface supports.

Modes 0 to 4 will increase performance progressively. In Auto mode, the system automatically determines the best mode for each device.

The Choices: Auto (default), Mode0, Mode1, Mode2, Mode3, and Mode4.

Primary / Secondary /Master / Slave UDMA

Ultra DMA/100 functionality can be implemented if it is supported by the IDE hard drives in your system. As well, your operating environment requires a DMA driver (Windows 95 OSR2 or a third party IDE bus master driver). If your hard drive and your system software both support Ultra DMA/100, select Auto to enable BIOS support.

The Choices: Auto (default), Disabled.

6 Power Management Setup

The Power Management Setup Menu allows you to configure your system to utilize energy conservation and power up/power down features.

■ **Figure 6. Power Management Setup**

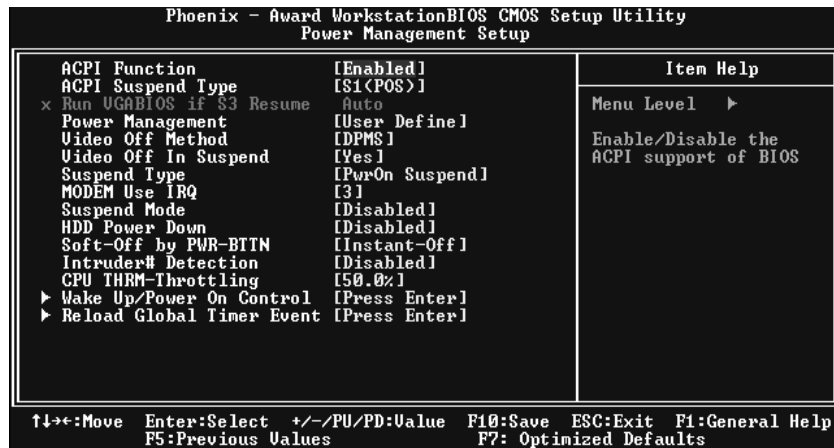

ACPI Function

This item displays the status of the Advanced Configuration and Power Management (ACPI).

The Choices: Enabled (default), Disabled.

ACPI Suspend Type (Optional: not for P4TPT version 7.0)

The item allows you to select the suspend type under the ACPI operating system.

The Choices: S1 (POS) (default) Power on Suspend
S3 (STR) Suspend to RAM
S1 & S3 POS+STR

Run VGABIOS if S3 Resume (Optional: not for P4TPT version 7.0)

Choosing Enabled will make BIOS run VGA BIOS to initialize the VGA card when system wakes up from S3 state. The system time is shortened if you disable the function, but system will need AGP driver to initialize the card. So, if the AGP driver of the VGA card does not support the initialization feature, the display may work abnormally or not function after S3.

The Choices: Auto (default), Yes, No.

P4TPT BIOS Manual

Power Management

This category allows you to select the type (or degree) of power saving and is directly related to the following modes:

- 1.HDD Power Down.
- 2.Doze Mode.
- 3.Suspend Mode.

There are four options of Power Management, three of which have fixed mode settings

Min. Saving

Minimum power management.
Doze Mode = 1 hr.
Standby Mode = 1 hr
Suspend Mode = 1 hr.
HDD Power Down = 15 min

Max Saving

Maximum power management only available for sl CPU's.
Doze Mode = 1 min
Standby Mode = 1 min.
Suspend Mode = 1 min.
HDD Power Down = 1 min.

User Defined (default)

Allow you to set each mode individually.
When not disabled, each of the ranges are from 1 min. to 1 hr. except for HDD Power Down which ranges from 1 min. to 15 min. and disable.

Video Off Method

This option determines the manner in which the monitor is goes blank.

V/H SYNC + Blank

This selection will cause the system to turn off the vertical and horizontal synchronization ports and write blanks to the video buffer.

Blank Screen

This option only writes blanks to the video buffer.

DPMS (default)

Initial display power management signaling.

P4TPT BIOS Manual

Video Off In Suspend

This determines the manner in which the monitor is blanked.

The Choices: Yes (default), No.

Suspend Type

This item allows you to select the legacy suspend mode method.

The Choices: Stop Grant, **PwrOn Suspend** (default).

MODEM Use IRQ

This determines the IRQ, which can be applied in MODEM use.

The Choices:3 (default)

4 / 5 / 7 / 9 / 10 / 11 / NA

Suspend Mode

When enabled and after the set time of system inactivity, all devices except the CPU will be shut off.

The Choices: Disabled (default), 1Min, 2Min, 4Min, 8Min, 12Min, 20Min, 30Min, 40Min, and 1Hour.

HDD Power Down

When enabled and after the set time of system inactivity, the hard disk drive will be powered down while all other devices remain active.

The Choices: Disabled (default), 1Min, 2Min, 3Min, 4Min, 5Min, 6Min, 7Min, 8Min, 9Min, 10Min, 11Min, 12Min, 13Min, 14Min, 15Min.

Soft-Off by PWR-BTTN

Pressing the power button for more than 4 seconds forces the system to enter the Soft-Off state when the system has "hung."

The Choices: Delay 4 Sec, **Instant-Off** (default).

Intruder# Detection

This item allows you to enable or disable intruder# detection.

The Choices: Disabled (**Default**), Enabled.

CPU THRM-Throttling

Select the CPU THRM-Throttling rate.

The Choices: 87.5%, 75.5%, 62.5%, **50.0%** (default), 37.5%, 25%, 12.5%.

P4TPT BIOS Manual

Wake-Up/Power On Control

If you highlight the literal “Press Enter” next to the “Wake-Up/ Power On Control” label and then press the enter key, it will take you a submenu with the following options:

Wake-Up by PCI card

When you select enable, a PME signal from PCI card returns the system to Full On state.

The Choices: Enabled, **Disabled** (default).

Power On by Ring

An input signal on the serial Ring Indicator (RI) line (in other words, an incoming call on the modem) awakens the system from a soft off state.

The Choices: Enabled, **Disabled** (default).

Wake Up On LAN

To use this function, you need a LAN add-on card which support power on function. It should also support the wake-up on LAN jumper.

The Choices: Enabled, **Disabled** (default).

USB KB Wake-Up From S3 (Optional: not for P4TPT version 7.0)

This item allows you to enable/ disable USB KB wake up from S3.

The Choices: **Disabled** (default), Enabled.

Resume by Alarm

This function is for setting date and time for your computer to boot up. During Disabled, you cannot use this function. During Enabled, Choose the Date and Time.

Alarm: **Date (of Month) Alarm** You can choose which month the system will boot up.

Time (hh:mm:ss) Alarm You can choose what hour, minute and second the system will boot up.

Note: If you have change the setting, you must let the system boot up until it goes to the operating system, before this function will work.

KBD Power On Function

This item allows you to select the various functions of KB to Power on the system.

The Choices: **Disabled** (Default), Enabled.

KB Power On Password

This item allows you to enter a password with at least 5 characters.

HOT Key Power On

This item allows you to set the hot key to power on system.

The Choices: **Ctrl-F1** (Default), Ctrl-F2, Ctrl-F3, Ctrl-F4, Ctrl-F5, Ctrl-F6, Ctrl-F7, Ctrl-F8, Ctrl-F9, Ctrl-F10, Ctrl-F11, Ctrl-F12.

P4TPT BIOS Manual

PWRON After PWR-Fail

This field determines the action the system will automatically take when power is restored to a system that had lost power previously without any subsequent manual intervention. There are 3 sources that provide current to the CMOS area that retains these Power-On instructions; the motherboard battery (3V), the Power Supply (5VSB), and the Power Supply (3.3V). While AC is not supplying power, the motherboard uses the motherboard battery (3V). If AC power is supplied and the Power Supply is not turned on, 5VSB from the Power Supply is used. When the Power Supply is eventually turned on 3.3V from the Power Supply will be used.

There are 3 options: "Former-Sts", "On", "Off".

"Off" (default) Means always set CMOS to the "Off" status when AC power is lost.

"On" Means always set CMOS to the "On" status when AC power is lost

"Former-Sts" Means to maintain the last status of the CMOS when AC power is lost.

For example: If set to "Former-Sts" and AC power is lost when system is live, then after AC power is restored, the system will automatically power on. If AC power is lost when system is not live, system will remain powered off.

Reload Global Timer Event

Reload Global Timer Events are I/O events whose occurrence can prevent the system from entering a power saving mode or can awaken the system from such a mode. In effect, the system remains alert for anything, which occurs to a device, which is configured as *Enabled*, even when the system is in a power down mode.

Primary IDE 0/1

Secondary IDE 0/1

FDD, COM, LPT Port

PCI PIRQ [A-D]#

7 PnP/PCI Configurations

This section describes configuring the PCI bus system. PCI, or Personal Computer Interconnect, is a system that allows I/O devices to operate at speeds nearing the speed of the CPU itself uses when communicating with its own special components. This section covers some very technical items and it is strongly recommended that only experienced users should make any changes to the default settings.

■ **Figure 7. PnP/PCI Configurations**



Reset Configuration Data

The system BIOS supports the PnP feature that requires the system to record which resources are assigned and protects resources from conflict. Every peripheral device has a node, which is called ESCD. This node records which resources are assigned to it. The system needs to record and update ESCD to the memory locations. These locations (4K) are reserved in the system BIOS. If the Disabled (default) option is chosen, the system's ESCD will update only when the new configuration varies from the last one. If the Enabled option is chosen, the system is forced to update ESCDs and then is automatically set to the "Disabled" mode.

The above settings will be shown on the screen only if "Manual" is chosen for the resources controlled by function.

Legacy is the term, which signifies that a resource is assigned to the ISA Bus and provides non-PnP ISA add-on cards. PCI / ISA PnP signifies that a resource is assigned to the PCI Bus or provides for ISA PnP add-on cards and peripherals.

The Choices: Disabled (default), Enabled.

P4TPT BIOS Manual

Resources Controlled By

By Choosing “**Auto (ESCD)**” (default), the system BIOS will detect the system resources and automatically assign the relative IRQ and DMA channel for each peripheral. By Choosing “**Manual**”, the user will need to assign IRQ & DMA for add-on cards. Be sure that there are no IRQ/DMA and I/O port conflicts.

IRQ Resources

This submenu will allow you to assign each system interrupt a type, depending on the type of device using the interrupt. When you press the “Press Enter” tag, you will be directed to a submenu that will allow you to configure the system interrupts. This is only configurable when “Resources Controlled By” is set to “Manual”.

IRQ-3	assigned to	PCI Device
IRQ-4	assigned to	PCI Device
IRQ-5	assigned to	PCI Device
IRQ-7	assigned to	PCI Device
IRQ-9	assigned to	PCI Device
IRQ-10	assigned to	PCI Device
IRQ-11	assigned to	PCI Device
IRQ-12	assigned to	PCI Device
IRQ-14	assigned to	PCI Device
IRQ-15	assigned to	PCI Device

PCI/ VGA Palette Snoop

Choose Disabled or Enabled. Some graphic controllers that are not VGA compatible take the output from a VGA controller and map it to their display as a way to provide boot information and VGA compatibility.

However, the color information coming from the VGA controller is drawn from the palette table inside the VGA controller to generate the proper colors, and the graphic controller needs to know what is in the palette of the VGA controller. To do this, the non-VGA graphic controller watches for the Write access to the VGA palette and registers the snoop data. In PCI based systems, where the VGA controller is on the PCI bus and a non-VGA graphic controller is on an ISA bus, the Write Access to the palette will not show up on the ISA bus if the PCI VGA controller responds to the Write.

In this case, the PCI VGA controller should not respond to the Write, it should only snoop the data and permit the access to be forwarded to the ISA bus. The non-VGA ISA graphic controller can then snoop the data on the ISA bus. Unless you have the above situation, you should disable this option.

Disabled (default)	Disables the function.
Enabled	Enables the function.

8 PC Health Status

■ Figure 8. PC Health Status

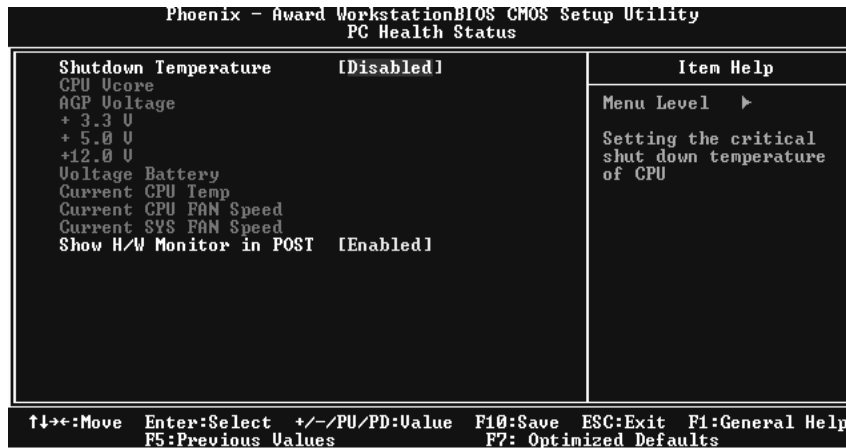

Shutdown Temperature

This item allows you to set up the CPU shutdown Temperature. This item only effective under Windows 98 ACPI mode.

The Choices: 60°C/140°F, 65°C/149°F, 70°C/158°F, **Disabled** (default).

CPU Vore/AGP Voltage/+3.3V/+5.0V/+12V//Voltage Battery

Detect the system's voltage status automatically.

Current CPU Temp

Show you the current CPU1 temperature.

Current CPU FAN Speed

This field displays the current CPUFAN speed.

Current SYS FAN Speed

This field displays the current speed SYSTEM fan.

Show H/W Monitor in POST

If you computer contain a monitoring system, it will show PC health status during POST stage. The item offers several delay time to select you want.

The Choices: **Enabled** (default), Disabled.

9 Frequency Control

■ Figure 9. Frequency Control

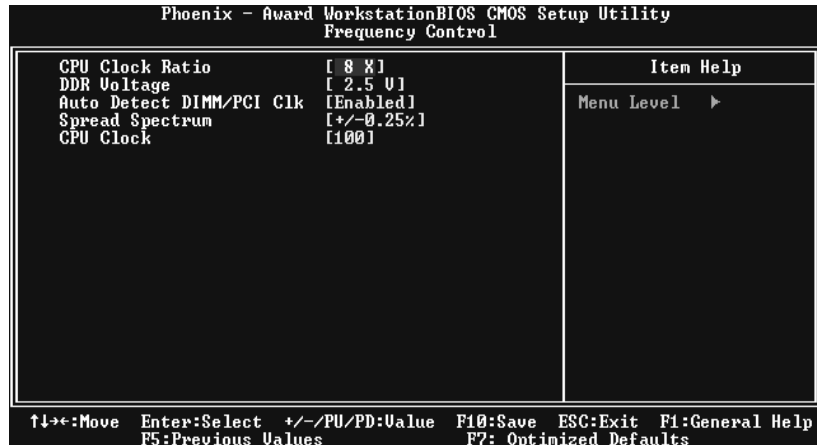

CPU Clock Ratio

This item allows you to select the CPU Ratio.

DDR Voltage

This item allows you to select DDR Voltage Regulator.

The Choices: 2.5V (Default), 2.6, 2.7, and 2.8.

Auto Detect DIMM/PCI Clk

This item allows you to enable / disable auto Detect PCI Clock.

The Choices: Enabled (default), Disabled.

CPU Clock

This item allows you to select CPU Clock, and CPU over clocking.



If unfortunately, the system's frequency that you are selected is not functioning, there are two methods of booting-up the system.

Method 1: Clear the COMS data by setting the JCOMS1 ((2-3) closed)) as "ON" status. All the CMOS data will be loaded as defaults setting.

Method 2: Press the <Insert> key and Power button simultaneously, after that keep-on pressing the <Insert> key until the power-on screen showed. This action will boot-up the system according to FSB of the processor.

※ **It's strongly recommended to set CPU Vcore and clock in default setting. If the CPU Vcore and clock are not in default setting, it may cause CPU or M/B damage.**