

***P4XFM/P4XFMU/P4MFM/P4MFMU
P4MFU533/P4MFP533
P4MFU533T/P4MFP533T
USER'S MANUAL***

M/B For Socket 478 Pentium 4 Processor

NO. G03-P4XFMR9A

Release date: March 2003

Trademark:

* Specifications and Information contained in this documentation are furnished for information use only, and are subject to change at any time without notice, and should not be construed as a commitment by manufacturer.

TABLE OF CONTENT

USER'S NOTICE	1
MANUAL REVISION INFORMATION	1
COOLING SOLUTIONS	1
CHAPTER1 INTRODUCTION OF P4XFM//P4XFMU/P4MFM/P4MFMU/ P4MFU533/P4MFP533/P4MFMU533T/P4MFP533T MOTHERBOARD	
1-1 FEATURE OF MOTHERBOARD	2
1-2 SPECIFICATION	3
1-3 PERFORMANCE LIST.....	4
1-4 LAYOUT DIAGRAM & JUMPER SETTING.....	5
CHAPTER 2 HARDWARE INSTALLATION	
2-1 HARDWARE INSTALLATION STEPS	7
2-2 CHECKING MOTHERBOARD'S JUMPER SETTING	7
2-3 INSTALL CPU	8
2-3-1 GLOSSARY.....	8
2-3-2 ABOUT INTEL PENTIUM 4 478-PIN CPU.....	9
2-4 INSTALL MEMORY.....	9
2-5 EXPANSION CARD	10
2-5-1 PROCEDURE FOR EXPANSION CARD INSTALLATION	10
2-5-2 ASSIGNING IRQ FOR EXPANSION CARD	11
2-5-3 INTERRUPT REQUEST TABLE FOR THIS MOTHERBOARD	11
2-5-4 AGP SLOT	12
2-6 CONNECTORS, HEADERS.....	12
2-6-1 CONNECTORS	12
2-6-2 HEADERS	15
2-7 STARTING UP YOUR COMPUTER	18
CHAPTER 3 INTRODUCING BIOS	
3-1 ENTERING SETUP	19
3-2 GETTING HELP.....	19
3-3 THE MAIN MENU	20
3-4 STANDARD CMOS FEATURES.....	21
3-5 ADVANCED BIOS FEATURES.....	22
3-6 ADVANCED CHIPSET FEATURES.....	24
3-6-1 DRAM TIMING SETTINGS	25
3-6-2 AGP FUNCTION SETTINGS.....	26
3-6-3 PCI TIMING SETTINGS.....	26
3-7 INTEGRATED PERIPHERALS	26
3-7-1 ONCHIP IDE FUNCTION.....	27
3-7-2 ONCHIP DEVICE FUNCTION	28
3-7-3 ONCHIP SUPER IO FUNCTION	29
3-8 POWER MANAGEMENT SETUP	30
3-8-1 PM WAKE UP EVENTS	31
3-8-1.1 IRQS ACTIVITIES	31
3-9 PNP/PCI CONFIGURATION SETUP.....	32
3-9-1 IRQ RESOURCES.....	33
3-10 PC HEALTH STATUS.....	33
3-11 MISCELLANEOUS CONTROL.....	34
3-12 LOAD STANDARD/OPTIMIZED DEFAULTS.....	35
3-13 SET SUPERVISOR/USER PASSWORD	35
CHAPTER 4 DRIVER & FREE PROGRAM INSTALLATION	
MAGIC INSTALL SUPPORTS WINDOWS 9X/ME/NT4.0/2000/XP	36
4-1 VIA 4 IN 1 INSTALL VIA SERVICE PACK 4 IN 1 DRIVER	37
4-2 VGA INSTALL VIA P4M266 VGA DRIVER.....	38
4-3 SOUND INSTALL ALC/CM I AUDIO CODEC DRIVER	39
4-4 LAN INSTALL VIA 10/100MB LAN CONTROLLER DRIVER	41
4-5 PC-HEALTH WINBOND HARDWARE DOCTOR MONITORING SOFTWARE.....	42
4-6 MAGIC BIOS INSTALL BIOS LIVE UPDATE UTILITY	43
4-7 USB2.0 INSTALL VIA USB2.0 DEVICE DRIVER.....	44
4-8 PC-CILLIN INSTALL PC-CILLIN2002 ANTI-VIRUS PROGRAM.....	45
4-9 HOW TO DISABLE ON-BOARD SOUND	46
4-10 HOW TO UPDATE BIOS	46

USER'S NOTICE

COPYRIGHT OF THIS MANUAL BELONGS TO THE MANUFACTURER. NO PART OF THIS MANUAL, INCLUDING THE PRODUCTS AND SOFTWARE DESCRIBED IN IT MAY BE REPRODUCED, TRANSMITTED OR TRANSLATED INTO ANY LANGUAGE IN ANY FORM OR BY ANY MEANS WITHOUT WRITTEN PERMISSION OF THE MANUFACTURER.

THIS MANUAL CONTAINS ALL INFORMATION REQUIRED TO USE P4XFM/P4XFMU/P4MFM/P4MFU533/P4MFP533/P4MFU533T/P4MFP533T MOTHER-BOARD AND WE DO ASSURE THIS MANUAL MEETS USER'S REQUIREMENT BUT WILL CHANGE, CORRECT ANY TIME WITHOUT NOTICE. MANUFACTURER PROVIDES THIS MANUAL "AS IS" WITHOUT WARRANTY OF ANY KIND, AND WILL NOT BE LIABLE FOR ANY INDIRECT, SPECIAL, INCIDENTAL OR CONSEQUENTIAL DAMAGES (INCLUDING DAMAGES FOR LOSS OF PROFIT, LOSS OF BUSINESS, LOSS OF USE OF DATA, INTERRUPTION OF BUSINESS AND THE LIKE).

PRODUCTS AND CORPORATE NAMES APPEARING IN THIS MANUAL MAY OR MAY NOT BE REGISTERED TRADEMARKS OR COPYRIGHTS OF THEIR RESPECTIVE COMPANIES, AND THEY ARE USED ONLY FOR IDENTIFICATION OR EXPLANATION AND TO THE OWNER'S BENEFIT, WITHOUT INTENT TO INFRINGE.

Manual Revision Information

Reversion	Revision History	Date
9.0	Ninth Edition	March 2003

Item Checklist

- P4XFM/P4XFMU/P4MFM/P4MFMU/P4MFU533/P4MFP533/P4MFMU533T/P4MFP533T motherboard
- Cable for IDE/Floppy
- Cable for COM2 Connector (Option)
- CD for motherboard utilities
- Cable for USB Port 3/4 (Option)
- P4XFM/P4XFMU/P4MFM/P4MFMU/P4MFU533/P4MFP533/P4MFMU533T/P4MFP533T User's Manual

Intel Pentium 4 Processor Family

Cooling Solutions

As processor technology pushes to faster speeds and higher performance, thermal management becomes increasingly crucial when building computer systems. Maintaining the proper thermal environment is key to reliable, long-term system operation. The overall goal in providing the proper thermal environment is keeping the processor below its specified maximum case temperature. Heatsinks induce improved processor heat dissipation through increased surface area and concentrated airflow from attached fans. In addition, interface materials allow effective transfers of heat from the processor to the heatsink. For optimum heat transfer, Intel recommends the use of thermal grease and mounting clips to attach the heatsink to the processor.

When selecting a thermal solution for your system, please refer to the website below for collection of heatsinks evaluated and recommended by Intel for use with Intel processors. Note, those heatsinks are recommended for maintaining the specified Maximum T case requirement. In addition, this collection is not intended to be a comprehensive listing of all heatsinks that support Intel processors.

For vendor list of heatsink and fan, please visit :

<http://developer.intel.com/design/Pentium4/components/index>

Chapter 1

Introduction of P4XFM/P4XFMU/P4MFM/P4MFMU/ P4MFU533/P4MFP533/P4MFU533T/P4MFP533T Motherboard

1-1 Feature of motherboard

The P4XFM/ P4XFMU/ P4MFM/ P4MFMU/ P4MFU533/ P4MFP533/ P4MFU533T/ P4MFP533T motherboard is design for use Intel Pentium 4 Processor in 478 Pin Package Processor with the VIA P4X266E/P4M266/P4M266A(CE) Chipset delivers a high performance and professional desktop platform solution. Which utilize the Socket 478 design and the memory size expandable to 2.0GB.

These motherboards use the newest VIA P4X266E/P4M266/P4M266A(CE) Chipset. Supports 533MHz System Bus in data transfer rate for P4XFM/P4XFMU/P4MFU533/ P4MFP533/P4MFU533T/P4MFP533T, ***P4MFU533T/P4MFP533T motherboard supports Hyper Threading CPU***, and 400MHz System Bus in data transfer rate in P4MFM/P4MFMU. The motherboard provided 100MHz/133MHz Memory clock frequency, support PC133/ PC100 SDRAM and DDR266/DDR200 DDR Module. The VIA VT8233A/VT8235 V-Link LPC South Bridge in P4XFM/ P4XFMU/ P4MFM/ P4MFMU/ P4MFU533/ P4MFP533/ P4MFU533T /P4MFP533T offer ULTRA ATA **133** to provide speedier HDD throughout that boosts overall system performance.

The P4MFP533T embedded VIA VT6103 PHYceiver offer LAN function provide 10/100 MHz full and half duplex operation.

These motherboards also has an integrated AC'97 2.1 CODEC on board which is fully compatible with Sound Blaster Pro® that gives you the best sound quality and compatibility.

The P4MFM/P4MFMU/P4MFU533/P4MFP533/P4MFU533T/P4MFP533T integrated High Performance & High Quality 3D Accelerator supports Ultra-AGP II with 2GB/s bandwidth, built-in MPEG-2/1 Video Decoder and Video Accelerator supports VCD DVD HDTV decoding and playback, supports graphic and video overlay function. Built-in programmable 24-bit true-color RAMDAC up to 250MHz pixel clock. Programmable frame buffer size from 8MB and up to 32MB. For those wanting even greater graphic performance, an AGP 4X slot is included on the board, support AGP 2X/4X capability and Fast write Transaction.

With USB control as well as capability of expanding to 4 USB 1.1 function ports for P4XFM/P4MFM delivering 2x12Mb/s bandwidth, expanding to 6 USB 2.0 function ports for P4XFMU/P4MFMU/P4MFU533/P4MFP533/P4MFU533T/P4MFP533T delivering 480Mb/s bandwidth and rich connectivity, these motherboards meet future USB demand also has built-in hardware monitor function to monitor and protect your computer.

A useful software tool “Magic BIOS” examines the BIOS version automatically with the correct version available on the web, links the site for users to download the latest version of BIOS and updates the BIOS. Use “Magic BIOS”, users can download and update BIOS automatically and completed under the OS easily.

These motherboards provide high performance & meets future specification demand. It is really wise choice for your computer.

1-2 Specification

Spec	Description
------	-------------

Design	* Micro ATX form factor 4 layers PCB size: 24.4x24.4cm
Chipset	* VIA P4X266E North Bridge Chipset for P4XFM/P4XFMU VIA P4M266 North Bridge Chipset for P4MFM/P4MFMU P4M266A North Bridge for P4MFU533/P4MFP533 P4M266A(CE) North Bridge for P4MFU533T/P4MFP533T * VIA VT8233A South Bridge Chipset for P4XFM/P4MFM VIA VT8235 South Bridge for P4XFMU/P4MFMU /P4MFU533/P4MFP533/P4MFU533T/P4MFP533T
CPU Socket (mPGA478B Socket)	* Support Intel Pentium 4 478 Pin package utilizes Flip-Chip Pin Grid Array (FC-PGA2) package processor * Support 1.5G~2.8G 478 Pin Pentium 4 processor <i>P4MFU533T/P4MFP533T Support Hyper Threading CPU</i> * Reserves support for future Intel Pentium 4 processors
Memory Socket	* 168-pin SDR SDRAM module socket x2 and 184-pin DDR Module socket x 2 * Support 2 pcs PC133 SDRAM Module expandable to 1.0GB, or 2 pcs DDR266/DDR200 DDR Modules Expandable to 2.0GB
Expansion Slot	* AGP slot x1 support AGP 2.0 & 4X mode * 32-bit PCI slot x3
Integrate IDE	* Two PCI IDE controllers support PCI Bus Mastering, ATA PIO/DMA and the ULTRA DMA 33/66/100/133 functions that deliver the data transfer rate up to 133 MB/s
LAN (for P4MFP533 /P4MFP533T)	* Support Fast Ethernet LAN function provide 10/100 Mb/s data transfer rate
VGA (Only for P4Mxxx Serial Model)	* Integrated High Performance & High Quality 3D Accelerator * Support Ultra-AGP II with 2GB/s bandwidth * Built-in programmable 24-bit true-color RAMDAC up to 250MHz pixel clock * Programmable frame buffer size from 8MB and up to 32MB.
Audio	* AC'97 Digital Audio controller integrated * AC'97 Audio CODEC on board * Audio driver and utility included
BIOS	* Award 2MB Flash ROM
Multi I/O	* PS/2 keyboard and PS/2 mouse connectors * Floppy disk drive connector x1 * Parallel port x1, Serial port X2 * USB connector x2 * USB headers x4 (connecting cable option) * Audio connector (Line-in, Line-out , MIC & Game Port)

1-3 Performance List

The following performance data list is the testing result of some popular benchmark testing programs. These data are just referred by users, and there is no responsibility

for different testing data values gotten by users (the different Hardware & Software configuration will result in different benchmark testing results.)

Performance Test Report

CPU: Intel Pentium 4 1.9GHz mPGAB package
DRAM: 256MB DDR266 x1 (SAMSUNG K4H280838B-TCB0)
 256MB SDRAM x1 (KINGMAX KSV684T4A1A-06)
VGA Expansion Card: NVIDIA Geforce2 MX-400 64MB (1024x768xHi-color)
Hard Disk Driver: IBM DTLA-305040 (ATA-100)
BIOS: Award Optimal default
OS: Win 98SE

	DDR266	PC133 SDRAM
3D Mark 2000	5432	5360
3D Mark 2001	2509	2479
3D Winbench 2000	104	102
Final Reality	9.99	9.06
Content Creation Winstone 2000	43.2	41.5
Content Creation Winstone 2001	50.3	49.5
Content Creation Winstone 2002	20.1	18.6
Business Winstone2001	44.1	42.8
Winbench 99:		
CPU Mark 99	111	101
FPU Winmark 99	6610	6610
Business Disk Winmark99	7150	7090
Hi-end Disk Winmark99	18800	18500
Business Graphic Winmark	434	428
Hi-end Graphic Winmark	1260	1230
SYS Mark 2000/2001 : SISMark 2000/2001 Rating (Internet Content Creation / Office Productivity)		
SISMark 2000	208 (226/195)	200 (217/188)
SISMark 2001	150 (175/129)	142 (160/126)
SISOFT Sandra 2001 :		
Dhrystone ALU MIPS	3626	3630
Whetstone FPU MFLOPS	1137/2371	1135/2368
Int ALU/RAM MB/S	1181	701
Float FPU/RAM MB/S	1183	701
Integer SSE2 IT/S	7547	7554
Floating-Point SSE2 IT/S	9352	9350
QUAKE3 DEMO1 FPS	169.1	146.7
DEMO2 FPS	169.7	146.1
WCPUID System/CPU Clock	101/1918.93	101/1918.93

1-4 Layout Diagram & Jumper Setting

(For P4MFP533/P4MFP533T)

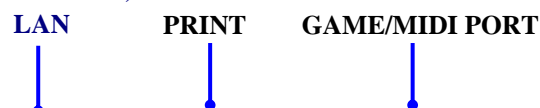

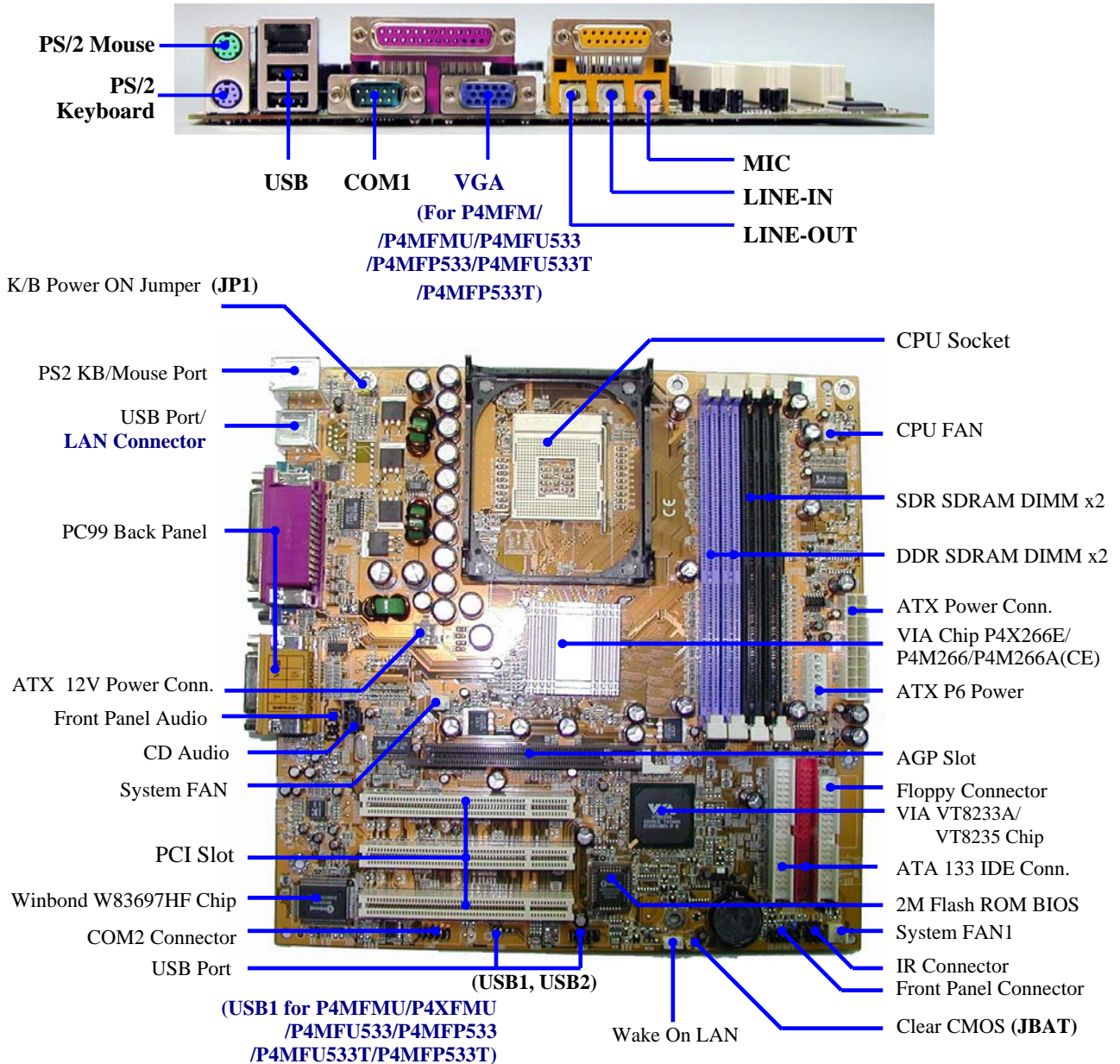

Jumpers

Jumper	Name	Description	Page
JBAT	CMOS RAM Clear	3-pin Block	P.7
JP1	Keyboard Power On Enable/Disabled	3-pin Block	P.7

Connectors

Connector	Name	Description	Page
ATXPWR	ATX Power Connector	20-pin Block	P.12
ATX12V	ATX 12V Power Connector	4-pin Block	P.12
ATXP6	ATX P6 Power Connector	6-pin Block	P.13
PS2KBM	PS/2 Mouse & PS/2 Keyboard Connector	6-pin Female	P.13
CN1	USB Port Connector	4-pin Connector	P.13
LAN (for P4MFP533/ P4MFP533T)	RJ-45 LAN Port Connector	RJ-45 Connector	P.13
PARALL	Parallel Port Connector	25-pin Female	P.13
AUDIO_GAME	Audio/Game Connector	3 phone jack + 15-pin Connector	P.13
COM1	Serial Port COM1 Connector	9-pin Connector	P.13
VGA	VGA Connector	15-pin Female	P.13
FDD	Floppy Driver Connector	34-pin Block	P.14
IDE1/IDE2	Primary/Secondary IDE Connector	40-pin Block	P.14

Only for P4MFM/P4MFMU/P4MFU533/P4MFP533/P4MFU533T/P4MFP533T

Headers

Header	Name	Description	Page
COM2	Serial Port COM2 header	9-pin Block	P.15
AUDIO	SPEAKER, MIC header	9-pin Block	P.15
USB2	USB Port Headers	9-pin Block	P.15
USB1 (for P4MFMU/P4XFMU/ P4MFU533/P4MFP533/ P4MFU533T/P4MFP533T)	USB Port Headers	9-pin Block	P.15
HD LED	IDE activity LED	2-pin Block	P.15
RESET	Reset switch lead	2-pin Block	P.15
SPEAK	PC Speaker connector	4-pin Block	P.15
PWR LED	Power LED	2-pin Block	P.16
PWR BTN	Power switch	2-pin Block	P.16
WOL	Wake On-LAN Headers	3-pin Block	P.16
SFAN1, SYSFAN, CPUFAN	FAN Headers	3-pin Block	P.16
IR	IR infrared module Headers	5-pin Block	P.17
CD_IN	CD Audio-In Headers	4-pin Block	P.17

Expansion Sockets

Socket/Slot	Name	Description	Page
ZIF Socket 478 Pin	CPU Socket	478-pin mPGA CPU Socket	P.9
SDR1, SDR2	SDRAM Module Socket	168-pin SDR SDRAM Module Expansion Socket	P.9
DDR1, DDR2	DDR Module Socket	184-pin DDR Module Socket	P.9
PCI1 ~ PCI3	PCI Slot	32-bit PCI Local Bus Expansion slots	P.10
AGP	AGP 4X Mode Slot	AGP Expansion Slot	P.12

Chapter 2

Hardware installation

2-1 Hardware installation Steps

Before using your computer, you had better complete the following steps:

-
-
1. Check motherboard jumper setting
 2. Install CPU and Fan
 3. Install System Memory (DIMM)
 4. Install Expansion cards
 5. Connect IDE and Floppy cables, Front Panel /Back Panel cable
 6. Connect ATX Power cable
 7. Power-On and Load Standard Default
 8. Reboot
 9. Install Operating System
 10. Install Driver and Utility

2-2 Checking Motherboard's Jumper Setting

(1) CMOS RAM Clear (3-pin) : JBAT

A battery must be used to retain the motherboard configuration in CMOS RAM short 1-2 pins of JBAT to store the CMOS data.

To clear the CMOS, follow the procedure below:

1. Turn off the system and unplug the AC power
2. Remove ATX power cable from ATX power connector
3. Locate JBAT and short pins 2-3 for a few seconds
4. Return JBAT to its normal setting by shorting pins 1-2
5. Connect ATX power cable back to ATX power connector

Note: When should clear CMOS

1. *Troubleshooting*
2. *Forget password*
3. *After over clocking system boot fail*

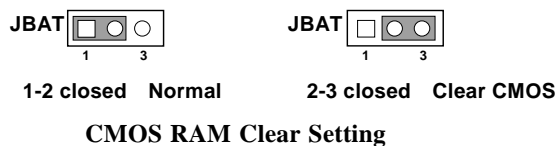
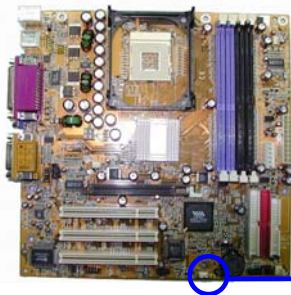

(2) Keyboard Power On function Enabled/Disabled: JP1

When setting Enabled you can using keyboard by key in password to power on system.

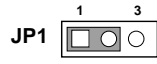
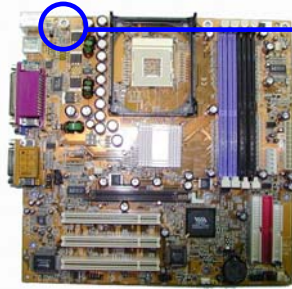

1-2 closed K/B Power ON Disable
(Default)

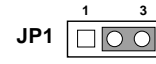

2-3 closed K/B Power ON Enabled

Keyboard Power On Setting

2-3 Install CPU

2-3-1 Glossary

Chipset (or core logic) - two or more integrated circuits which control the interfaces between the system processor, RAM, I/O devices, and adapter cards.

Processor slot/socket - the slot or socket used to mount the system processor on the motherboard.

Slot (AGP, PCI, ISA, RAM) - the slots used to mount adapter cards and system RAM.

AGP - Accelerated Graphics Port - a high speed interface for video cards; runs at 1X (66MHz), 2X (133MHz), or 4X (266MHz).

PCI - Peripheral Component Interconnect - a high speed interface for video cards, sound cards, network interface cards, and modems; runs at 33MHz.

ISA - Industry Standard Architecture - a relatively low speed interface primarily used for sound cards and modems; runs at approx. 8MHz.

Serial Port - a low speed interface typically used for mouse and external modems.

Parallel Port - a low speed interface typically used for printers.

PS/2 - a low speed interface used for mouse and keyboards.

USB - Universal Serial Bus - a medium speed interface typically used for mouse, keyboards, scanners, and some digital cameras.

Sound (interface) - the interface between the sound card or integrated sound connectors and speakers, MIC, game controllers, and MIDI sound devices.

LAN (interface) - **Local Area Network** - the interface to your local area network.

BIOS (Basic Input/Output System) - the program logic used to boot up a computer and establish the relationship between the various components.

Driver - software, which defines the characteristics of a device for use by another device or other software.

Processor - the "central processing unit" (CPU); the principal integrated circuit used for doing the "computing" in "personal computer"

Front Side Bus Frequency - the working frequency of the motherboard, which is generated by the clock generator for CPU, DRAM and PCI BUS.

CPU L2 Cache - the flash memory inside the CPU, normal it depend on CPU type.

2-3-2 About Intel Pentium 4 478-pin CPU

This motherboard provides a 478-pin surface mount, Zero Insertion Force (ZIF) socket, referred to as the mPGA478B socket supports Intel Pentium 4 processor in the 478 Pin package utilizes Flip-Chip Pin Grid Array (FC-PGA2) package technology.

The CPU that comes with the motherboard should have a cooling FAN attached to prevent overheating. If this is not the case, then purchase a correct cooling FAN before you turn on your system.

WARNING! Be sure that there is sufficient air circulation across the processor's heatsink and CPU cooling FAN is working correctly, otherwise it may cause the processor and motherboard overheat and damage, you may install an auxiliary cooling FAN, if necessary.

To install a CPU, first turn off your system and remove its cover. Locate the ZIF socket and open it by first pulling the level sideways away from the socket then upward to a 90-degree angle. Insert the CPU with the correct orientation as shown below. The notched corner should point toward the end of the level. Because the CPU has a corner pin for two of the four corners, the CPU will only fit in the orientation as shown.

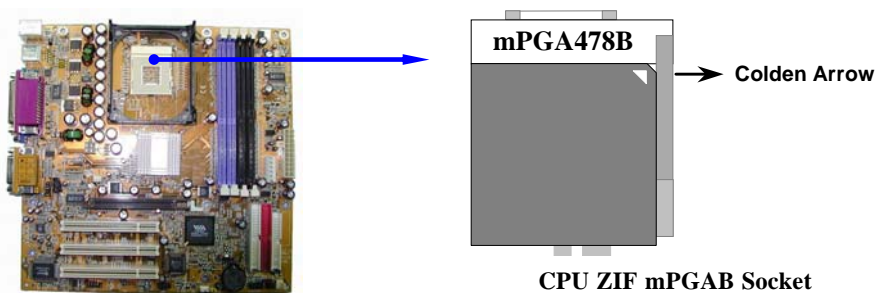

When you put the CPU into the ZIF socket. No force require to insert of the CPU, then press the level to Locate position slightly without any extra force.

2-4 Install Memory

This motherboard provides **two** 184-pin DDR DUAL INLINE MEMORY MODULES (DIMM) sites for DDR memory expansion available from minimum memory size of 64MB to maximum memory size of 2.0GB SDR SDRAM, or **two** 168-pin SDR DIMM sites for SDRAM memory for maximum memory size of 2.0GB.

Valid Memory Configurations

Bank	184-pin DDR DIMM	PCS	Total Memory
Bank 0, 1 (DDR1)	DDR266/DDR200 DDR DRAM Module	X1	64MB~1.0GB
Bank 2, 3 (DDR2)	DDR266/DDR200 DDR DRAM Module	X1	64MB~1.0GB
Total	System Memory (Max. 2.0GB)	X2	64MB~2.0GB
Bank	168-pin SDR DIMM	PCS	Total Memory
Bank 0, 1 (SDR1)	PC133/PC100 SDR DRAM Module	X1	64MB~1.0GB
Bank 2, 3 (SDR2)	PC133/PC100 SDR DRAM Module	X1	64MB~1.0GB
Total	System Memory (Max. 2.0GB)	X1	64MB~2.0GB

Generally, installing SDR/DDR SDRAM modules to your motherboard is very easy, you can refer to figure 2-4 to see what a 168-pin SDR/184-pin DDR SDRAM module looks like.

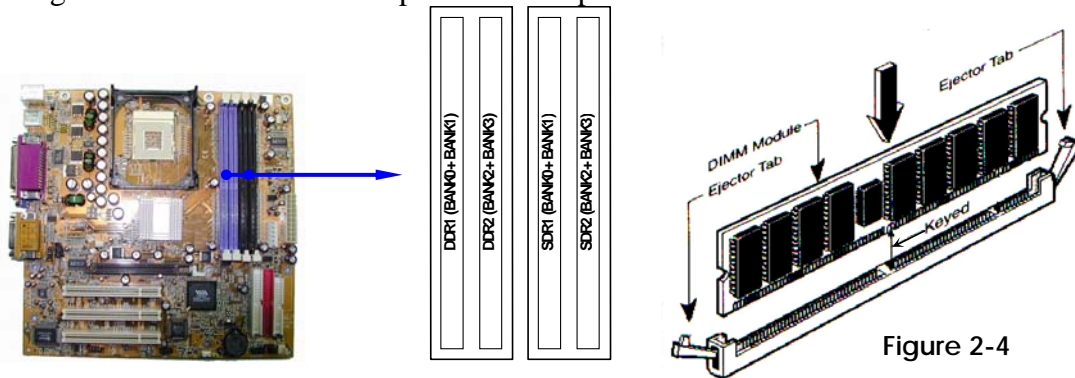

Figure 2-4

NOTE! When you install DIMM module fully into the DIMM socket the eject tab should be locked into the DIMM module very firmly and fit into its indentation on both sides.

WARNING! For the SDR SDRAM CLOCK is set at 133MHz, use only PC133/DDR266-compliant SDR/DDR Modules. When this motherboard operate at 133Mhz, most system will not even boot if non-compliant modules are used because of the strict timing issues, if your SDR/DDR Modules are not PC133/DDR266-compliant, set the SDRAM clock to 100MHz to ensure system stability.

NOTE! It is only can install either SDRAM or DDR Module at one time. Don't install both DDR Module and SDR Module at same time, it will have risk to damage your Memory and Motherboard.

2-5 Expansion Cards

WARNING! Turn off your power when adding or removing expansion cards or other system components. Failure to do so may cause severe damage to both your motherboard and expansion cards.

2-5-1 Procedure For Expansion Card Installation

1. Read the documentation for your expansion card and make any necessary hardware or software setting for your expansion card such as jumpers.
2. Remove your computer's cover and the bracket plate on the slot you intend to use.
3. Align the card's connectors and press firmly.
4. Secure the card on the slot with the screen you remove above.
5. Replace the computer system's cover.
6. Set up the BIOS if necessary.
7. Install the necessary software driver for your expansion card.

2-5-2 Assigning IRQs For Expansion Card

Some expansion cards need an IRQ to operate. Generally, an IRQ must exclusively assign to one use. In a standard design, there are 16 IRQs available but most of them are already in use.

Standard Interrupt Assignments

IRQ	Priority	Standard function
0	N/A	System Timer
1	N/A	Keyboard Controller
2	N/A	Programmable Interrupt
3 *	8	Communications Port (COM2)
4 *	9	Communications Port (COM1)
5 *	6	Sound Card (sometimes LPT2)
6 *	11	Floppy Disk Controller
7 *	7	Printer Port (LPT1)
8	N/A	System CMOS/Real Time Clock
9 *	10	ACPI Mode when enabled
10 *	3	IRQ Holder for PCI Steering
11 *	2	IRQ Holder for PCI Steering
12 *	4	PS/2 Compatible Mouse Port
13	N/A	Numeric Data Processor
14 *	5	Primary IDE Channel
15 *	1	Secondary IDE Channel

* These IRQs are usually available for ISA or PCI devices.

2-5-3 Interrupt Request Table For This Motherboard

Interrupt request are shared as shown the table below:

	INT A	INT B	INT C	INT D	INT E	INT F	INT G	INT H
Slot 1	√							
Slot 2		√						
Slot 3			√					
Onboard USB 1					√			
Onboard USB 2								√
AC97/MC97			√					

IMPORTANT! If using PCI cards on shared slots, make sure that the drivers support “Shared IRQ” or that the cards don’t need IRQ assignments. Conflicts will arise between the two PCI groups that will make the system unstable or cards inoperable.

2-5-4 AGP Slot

This motherboard provides an AGP Slot, support the 2X/4X AGP VGA card.

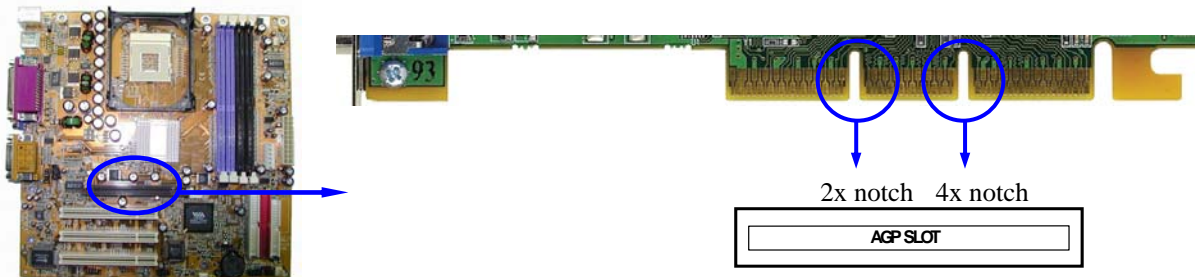

2-6 Connectors, Headers

2-6-1 Connectors

(1) Power Connector (20-pin block) : ATXPWR

ATX Power Supply connector. This is a new defined 20-pins connector that usually comes with ATX case. The ATX Power Supply allows to use soft power on momentary switch that connect from the front panel switch to 2-pins Power On jumper pole on the motherboard. When the power switch on the back of the ATX power supply turned on, the full power will not come into the system board until the front panel switch is momentarily pressed. Press this switch again will turn off the power to the system board.

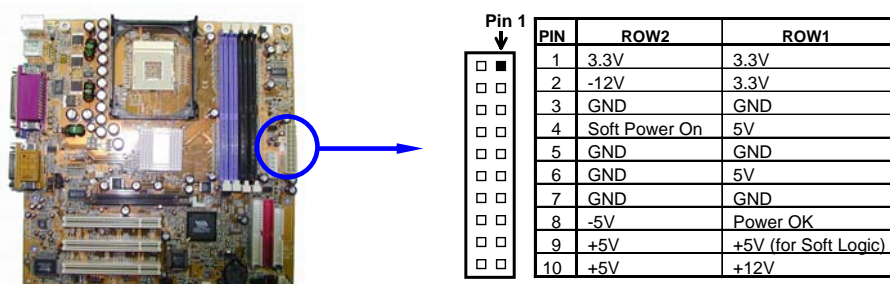

(2) ATX 12V Power Connector (4-pin block) : ATX12V

This is a new defined 4-pins connector that usually comes with ATX Power Supply. The ATX Power Supply which fully support Pentium 4 processor must including this connector for support extra 12V voltage to maintain system power consumption. Without this connector might cause system unstable because the power supply can not provide sufficient current for system.

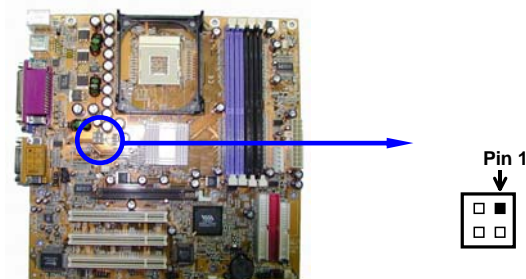

(3) ATX P6 Power Connector (6-pin block) : ATXP9

This is a new defined 6-pins connector that usually comes with ATX Power Supply. The ATX Power Supply which fully support Pentium 4 processor must including this connector for support extra 3.3V and 5V voltage to maintain system power consumption. Without this connector might cause system unstable because the power supply can not provide sufficient current for system.

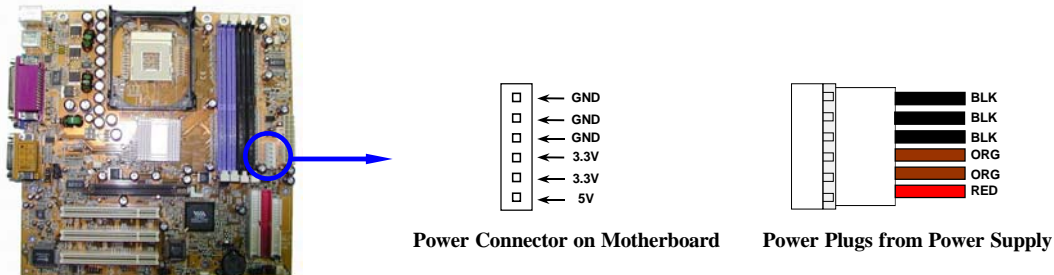

(4) PS/2 Mouse & PS/2 Keyboard Connector: PS2KBM

The connectors for PS/2 keyboard and PS/2 Mouse.

(5) USB Port connector: CN1

The connectors are 4-pin connector that connect USB devices to the system board.

(6) LAN Port connector: LAN (only for P4MFP533/P4MFP533T)

This connector is standard RJ45 connector for Network

(7) Parallel Port Connector (25-pin female): PARALL

Parallel Port connector is a 25-pin D-Subminiature Receptacle connector. The On-board Parallel Port can be disabled through the BIOS SETUP. Please refer to Chapter 3 “INTEGRATED PERIPHERALS SETUP” section for more detail information.

(8) Audio and Game Connector : AUDIO_GAME

This Connector are 3 phone Jack for LINE-OUT, LINE-IN, MIC and a 15-pin D-Subminiature Receptacle Connector for joystick/MIDI Device.

- Line-out :** Audio output to speaker
- Line-in :** Audio input to sound chip
- MIC :** Microphone Connector
- Game/MIDI :** For joystick or MIDI Device

(9) Serial Port COM1 : COM1

COM1 is the 9-pin D-Subminiature male connector. The On-board serial port can be disabled through BIOS SETUP. Please refer to Chapter 3 “INTEGRATED PERIPHERALS SETUP” section for more detail information.

(10) VGA Connector (15-pin D-Sub) Connector: VGA

(for P4MFM/P4MFMU/P4MFU533/P4MFP533/P4MFU533T/P4MFP533T)

VGA is the 15-pin D-Subminiature female connector for display monitor.

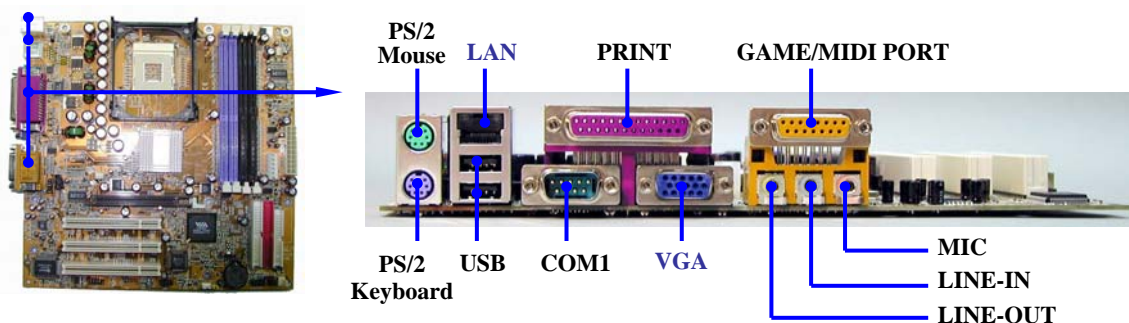

(11) Floppy drive Connector (34-pin block): FDD

This connector supports the provided floppy drive ribbon cable. After connecting the single plug end to motherboard, connect the two plugs at other end to the floppy drives.

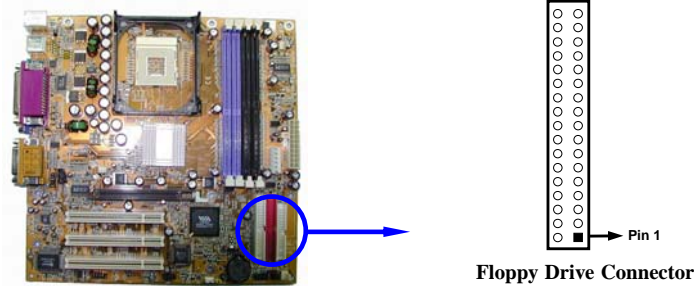

(12) Primary IDE Connector (40-pin block): IDE1

This connector supports the provided IDE hard disk ribbon cable. After connecting the single plug end to motherboard, connect the two plugs at other end to your hard disk(s). If you install two hard disks, you must configure the second drive to Slave mode by setting its jumpers accordingly. Please refer to the documentation of your hard disk for the jumper settings.

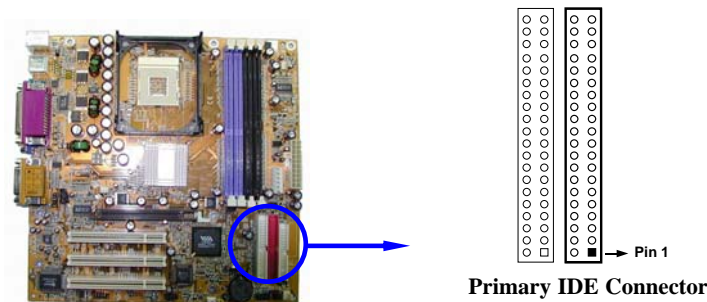

(13) Secondary IDE Connector (40-pin block): IDE2

This connector connects to the next set of Master and Slave hard disks. Follow the same procedure described for the primary IDE connector. You may also configure two hard disks to be both Masters using one ribbon cable on the primary IDE connector and another ribbon cable on the secondary IDE connector.

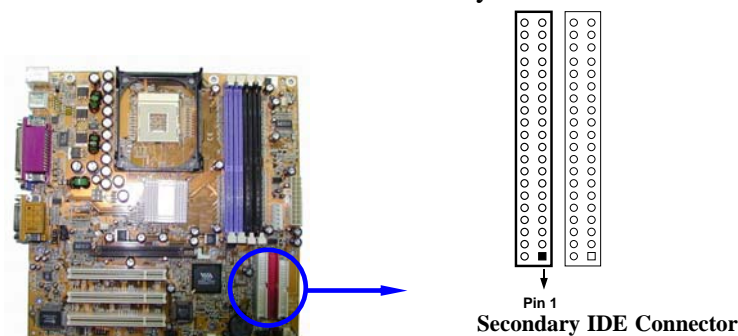

- Two hard disks can be connected to each connector. The first HDD is referred to as the “Master” and the second HDD is referred to as the “Slave”.
- For performance issues, we strongly suggest you don’t install a CD-ROM or DVD-ROM drive on the same IDE channel as a hard disk. Otherwise, the system performance on this channel may drop.

2-6-2 Headers

(1) Serial Port2 COM2 Header (9-pin) : COM2

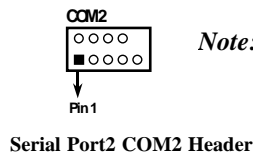
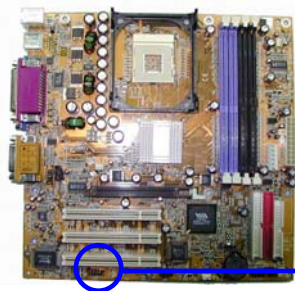

Note: Orient the read marking on the COM2 ribbon cable to pin 1

(2) Line-Out/MIC Header for Front Panel (9-pin): AUDIO

This header connect to Front Panel Line-out, MIC connector with cable.

Without install the cable, this header default setting is 5-6 short, 9-10 short. When you install the cable you have take off these jumpers.

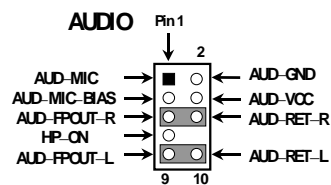
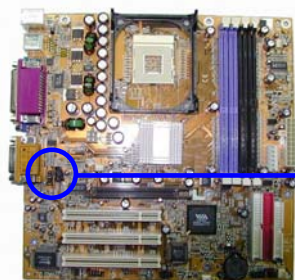

(3) USB Port Headers (9-pin) : USB2,

USB1 (for P4XFMU/P4MFMU/P4MFU533/P4MFP533/P4MFU533T/P4MFP533T)

These headers are used for connecting the additional USB port plug. By attaching an option USB cable, your can be provided with two additional USB plugs affixed to the back panel.

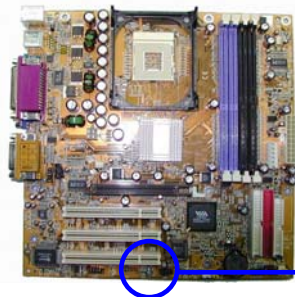

(4) IDE Activity LED: HD LED

This connector connects to the hard disk activity indicator light on the case.

(5) Reset switch lead: RESET

This 2-pin connector connects to the case-mounted reset switch for rebooting your computer without having to turn off your power switch. This is a preferred method of rebooting in order to prolong the life of the system's power supply. See the figure below.

(6) Speaker connector: SPEAK

This 4-pin connector connects to the case-mounted speaker. See the figure below.

(7) Power LED: PWR LED

The Power LED is light on while the system power is on. Connect the Power LED from the system case to this pin.

(8) Power switch: PWR BTN

This 2-pin connector connects to the case-mounted power switch to power ON/OFF the system.

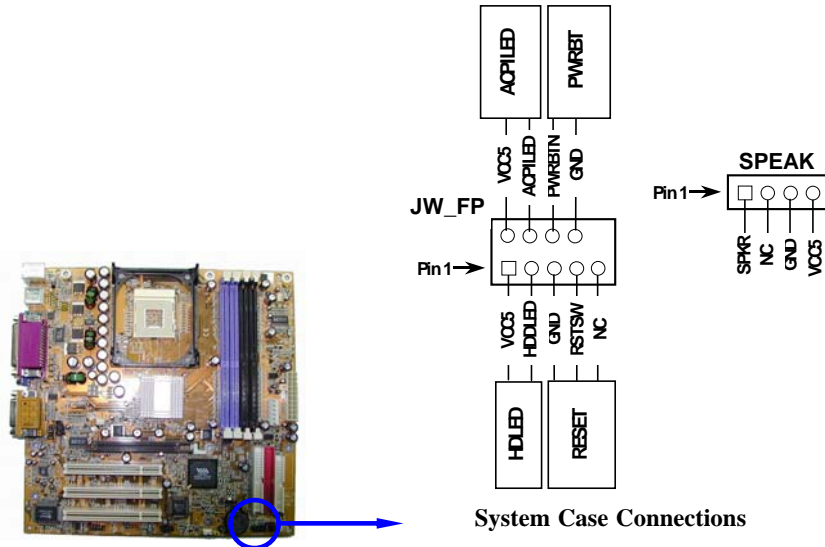

(9) Wake On-LAN Headers (3-pin) : WOL

This connector connects to a LAN card with a WAKE ON-LAN output. This connector power up the system when a wake up signal is received through the LAN card.

NOTE: This feature requires that Wake On LAN or Ring In Wake up is enabled.

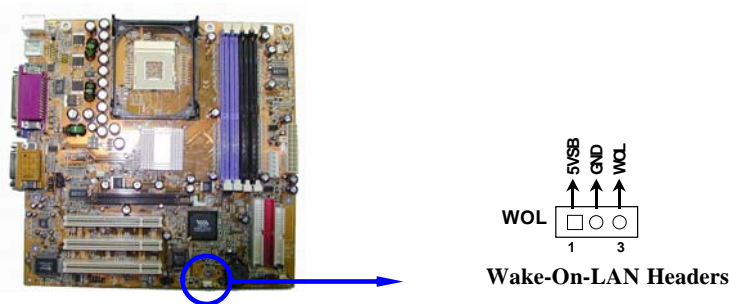

(10) FAN Headers (3-pin) : SFAN1, SYSFAN, CPUFAN

These connectors support cooling fans of 350mA (4.2 Watts) or less, depending on the fan manufacturer, the wire and plug may be different. The red wire should be positive, while the black should be ground. Connect the fan's plug to the board taking into consideration the polarity of connector.

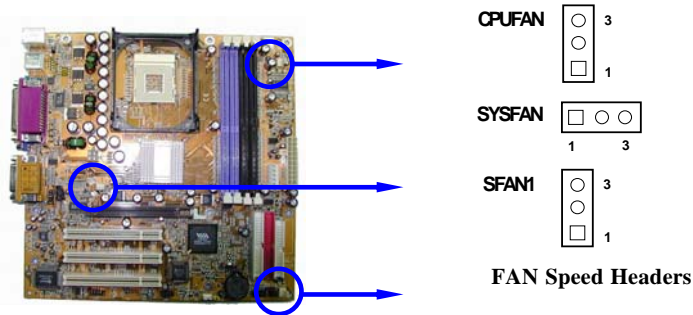

(11) IR infrared module Headers (5-pin) : IR

This connector supports the optional wireless transmitting and receiving infrared module. You must configure the setting through the BIOS setup to use the IR function.

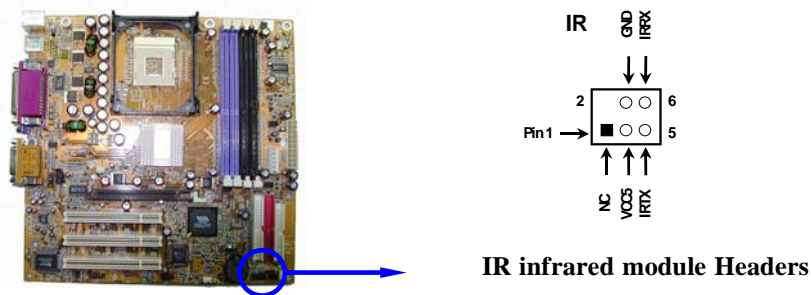

(12) CD Audio-In Headers (4-pin) : CD_IN

CD_IN are the connectors for CD-Audio Input signal. Please connect it to CD-ROM CD-Audio output connector.

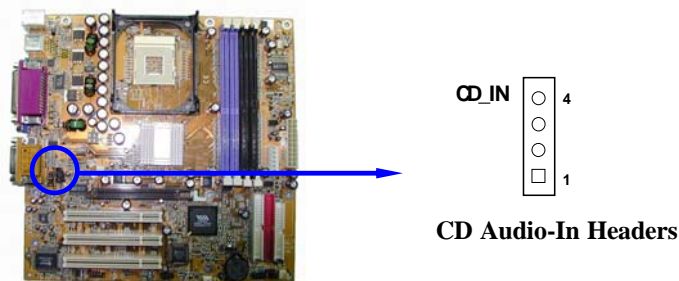

2-7 Starting Up Your Computer

1. After all connection are made, close your computer case cover.
2. Be sure all the switch are off, and check that the power supply input voltage is set to proper position, usually in-put voltage is 220V~240V or 110V~120V depending on your country's voltage used.
3. Connect the power supply cord into the power supply located on the back of your system case according to your system user's manual.
4. Turn on your peripheral as following order:
 - a. Your monitor.
 - b. Other external peripheral (Printer, Scanner, External Modem etc...)
 - c. Your system power. For ATX power supplies, you need to turn on the power supply and press the ATX power switch on the front side of the case.
5. The power LED on the front panel of the system case will light. The LED on the monitor may light up or switch between orange and green after the system is on. If it complies with green standards or if it is has a power standby feature. The system will then run power-on test. While the test are running, the BIOS will alarm beeps or additional message will appear on the screen.

If you do not see any thing within 30 seconds from the time you turn on the power. The system may have failed on power-on test. Recheck your jumper settings and connections or call your retailer for assistance.

Beep	Meaning
One short beep when displaying logo	No error during POST
Long beeps in an endless loop	No DRAM install or detected
One long beep followed by three short beeps	Video card not found or video card memory bad
High frequency beeps when system is working	CPU overheated System running at a lower frequency

6. During power-on, press <Delete> key to enter BIOS setup. Follow the instructions in BIOS SETUP.
7. **Power off your computer:** You must first exit or shut down your operating system before switch off the power switch. For ATX power supply, you can press ATX power switching after exiting or shutting down your operating system. If you use Windows 9X, click **“Start”** button, click **“Shut down”** and then click **“Shut down the computer?”** The power supply should turn off after windows shut down.

Chapter 3

Introducing BIOS

The BIOS is a program located on a Flash Memory on the motherboard. This program is a bridge between motherboard and operating system. When you start the computer, the BIOS program gain control. The BIOS first operates an auto-diagnostic test called POST (power on self test) for all the necessary hardware, it detects the entire hardware device and configures the parameters of the hardware synchronization. Only when these tasks are completed done it gives up control of the computer to operating system (OS). Since the BIOS is the only channel for hardware and software to communicate, it is the key factor for system stability, and in ensuring that your system performance as its best.

In the BIOS Setup main menu of Figure 3-1, you can see several options. We will explain these options step by step in the following pages of this chapter, but let us first see a short description of the function keys you may use here:

- Press <Esc> to quit the BIOS Setup.
- Press ↑↓←→ (up, down, left, right) to choose, in the main menu, the option you want to confirm or to modify.
- Press <F10> when you have completed the setup of BIOS parameters to save these parameters and to exit the BIOS Setup menu.
- Press Page Up/Page Down or +/- keys when you want to modify the BIOS parameters for the active option.

3-1 Entering Setup

Power on the computer and by pressing immediately allows you to enter Setup.

If the message disappears before your respond and you still wish to enter Setup, restart the system to try again by turning it OFF then ON or pressing the “RESET” button on the system case. You may also restart by simultaneously pressing <Ctrl>, <Alt> and <Delete> keys. If you do not press the keys at the correct time and the system does not boot, an error message will be displayed and you will again be asked to

Press <F1> to continue, <Ctrl-Alt-Esc> or to enter Setup

3-2 Getting Help

Main Menu

The on-line description of the highlighted setup function is displayed at the bottom of the screen.

Status Page Setup Menu/Option Page Setup Menu

Press F1 to pop up a small help window that describes the appropriate keys to use and the possible selections for the highlighted item. To exit the Help Window, press <Esc>.

3-3 The Main Menu

Once you enter Award® BIOS CMOS Setup Utility, the Main Menu (Figure 3-1) will appear on the screen. The Main Menu allows you to select from fourteen setup functions and two exit choices. Use arrow keys to select among the items and press <Enter> to accept or enter the sub-menu.

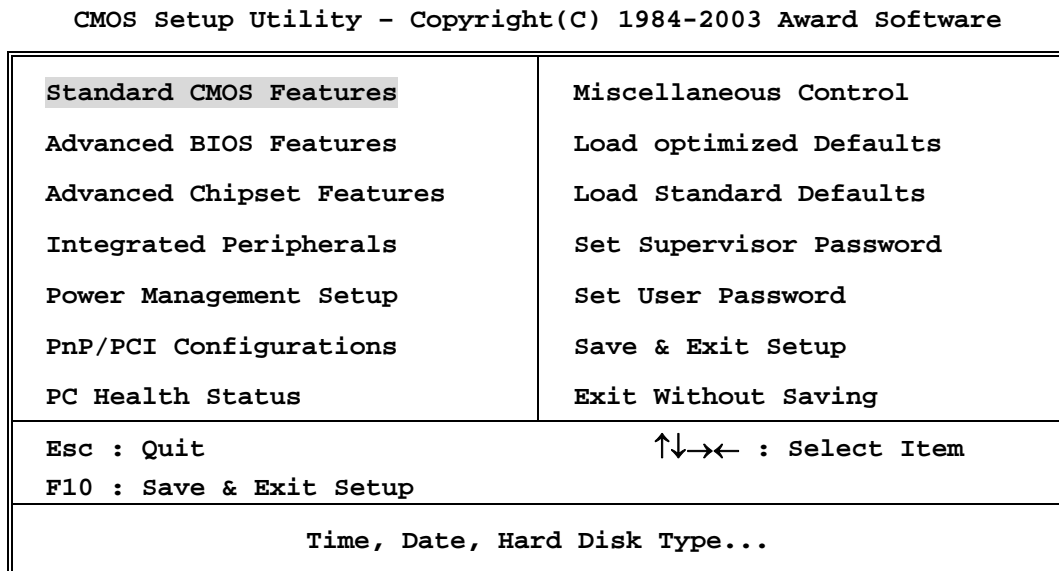

Figure 3-1

Standard CMOS Features

Use this Menu for basic system configurations.

Advanced BIOS Features

Use this menu to set the Advanced Features available on your system.

Advanced Chipset Features

Use this menu to change the values in the chipset registers and optimize your system's performance.

Integrated Peripherals

Use this menu to specify your settings for integrated peripherals.

Power Management Setup

Use this menu to specify your settings for power management.

PnP/PCI configurations

This entry appears if your system supports PnP/PCI.

PC Health Status

This entry shows your PC health status.

Miscellaneous Control

Use this menu to specify your settings for Miscellaneous control.

Load Optimized Defaults

Use this menu to load the BIOS default values these are setting for optimal performances system operations for performance use.

Load Standard Defaults

Use this menu to load the BIOS default values for the stable performance system operation that are factory settings for normal use.

Set Supervisor/User Password

Use this menu to set User and Supervisor Passwords.

Save & Exit Setup

Save CMOS value changes to CMOS and exit setup.

Exit Without Saving

Abandon all CMOS value changes and exit setup.

3-4 Standard CMOS Features

The items in Standard CMOS Setup Menu are divided into several categories. Each category includes no, one or more than one setup items. Use the arrow keys to highlight the item and then use the <PgUp> or <PgDn> keys to select the value you want in each item.

CMOS Setup Utility - Copyright(C) 1984-2003 Award Software

Standard CMOS Features

Date (mm:dd:yy)	Thu, Mar, 20 2003	Item Help
Time (hh:mm:ss)	16 : 48 : 35	
> IDE Primary Master	Press Enter None	Menu Level >
> IDE Primary Slave	Press Enter None	
> IDE Secondary Master	Press Enter None	
> IDE Secondary Slave	Press Enter None	Change the day, month, year and century
Drive A	1.44M, 3.25 in.	
Drive B	None	
Video	EGA/VGA	
Halt On	All,But Keyboard	
Base Memory	640K	
Extended Memory	56320K	
Total Memory	57344K	
↑↓→← Move Enter:Select +/-/PU/PD:Value F10:Save ESC:Exit F1:General Help F5:Previous Values F6:Optimized Defaults F7:Standard Defaults		

Date

The date format is <day><month><date><year>.

Day Day of the week, from Sun to Sat, determined by BIOS. Read-only.

Month The month from Jan. through Dec.

Date The date from 1 to 31 can be keyed by numeric function keys.

Year The year depends on the year of the BIOS.

Time

The time format is <hour><minute><second>.

Primary Master/Primary Slave

Secondary Master/Secondary Slave

Press PgUp/<+> or PgDn/<-> to select Manual, None, Auto type. Note that the specifications of your drive must match with the drive table. The hard disk will not work properly if you enter improper information for this category. If your hard disk drive type is not matched or listed, you can use Manual to define your own drive type manually.

If you select Manual, related information is asked to be entered to the following items. Enter the information directly from the keyboard. This information should be provided in the documentation from your hard disk vendor or the system manufacturer.

If the controller of HDD interface is SCSI, the selection shall be "None".

If the controller of HDD interface is CD-ROM, the selection shall be "None"

Access Mode The settings are Auto Normal, Large, and LBA.

Cylinder number of cylinders

Head number of heads

Precomp write precomp

Landing Zone landing zone

Sector number of sectors

3-5 Advanced BIOS Features

CMOS Setup Utility - Copyright(C) 1984-2003 Award Software

Advanced BIOS Features

		Item Help
Anti-Virus Protection	Disabled	
CPU L1 Cache	Enabled	
CPU L2 Cache	Enabled	
Quick Power On Self Test	Enabled	
First Boot Device	Floppy	Menu Level >
Second Boot Device	HDD-0	
Third Boot Device	CDROM	
Boot other Device	Enabled	
Swap Floppy Drive	Disabled	
Boot Up Floppy Seek	Enabled	
Boot Up NumLock Status	On	
Typematic Rate Setting	Disabled	
Typematic Rate (Chars/Sec)	6	
Typematic Delay (Msec)	250	
Security Option	Setup	
OS Select For DRAM > 64MB	Non-OS2	
HDD S.M.A.R.T. Capability	Disabled	
Report No FDD For Windows	Yes	
Video BIOS Shadow	Enabled	

↑↓→← Move Enter:Select +/-/PU/PD:Value F10:Save ESC:Exit F1:General Help
F5:Previous Values F6:Optimized Defaults F7:Standard Defaults

Anti-Virus Protection

Allows you to choose the VIRUS Warning feature for IDE Hard Disk boot sector protection. If this function is enabled and someone attempt to write data into this area, BIOS will show a warning message on screen and alarm beep.

Disabled (default) No warning message to appear when anything attempts to access the boot sector or hard disk partition table.

Enabled Activates automatically when the system boots up causing a warning message to appear when anything attempts to access the boot sector of hard disk partition table.

CPU Internal Cache

The default value is Enabled.

Enabled (default) Enable cache

Disabled Disable cache

Note: The internal cache is built in the processor.

External Cache

Choose Enabled or Disabled. This option enables the Level 2 cache memory.

CPU L2 Cache ECC Checking

Choose Enabled or Disabled. This option enables the Level 2 cache memory ECC (error check correction).

Quick Power On Self-Test

This category speeds up Power On Self Test (POST) after you power on the computer. If this is set to Enabled. BIOS will shorten or skip some check items during POST.

Enabled (default) Enable quick POST

Disabled Normal POST

First/Second/Third/Fourth Boot Device

The BIOS attempts to load the operating system from the devices in the sequence selected in these items. The settings are Floppy, LS/ZIP, HDD-0/HDD-1/HDD-3, SCSI, CDROM, LAD and Disabled.

Swap Floppy Drive

Switches the floppy disk drives between being designated as A and B. Default is Disabled.

Boot Up Floppy Seek

During POST, BIOS will determine if the floppy disk drive installed is 40 or 80 tracks. 360K type is 40 tracks while 760K, 1.2M and 1.44M are all 80 tracks.

Boot Up NumLock Status

The default value is On.

On (default) Keypad is numeric keys.

Off Keypad is arrow keys.

Typematic Rate Setting

Keystrokes repeat at a rate determined by the keyboard controller. When enabled, the typematic rate and typematic delay can be selected. The settings are: Enabled/Disabled.

Typematic Rate (Chars/Sec)

Sets the number of times a second to repeat a keystroke when you hold the key down. The settings are: 6, 8, 10, 12, 15, 20, 24, and 30.

Typematic Delay (Msec)

Sets the delay time after the key is held down before it begins to repeat the keystroke. The settings are 250, 500, 750, and 1000.

Security Option

This category allows you to limit access to the system and Setup, or just to Setup.

- System** The system will not boot and access to Setup will be denied if the correct password is not entered at the prompt.
- Setup (default)** The system will boot, but access to Setup will be denied if the correct password is not entered prompt.

OS Select For DRAM > 64MB

Allows OS2[®] to be used with >64MB or DRAM. Settings are Non-OS/2 (default) and OS2. Set to OS/2 if using more than 64MB and running OS/2[®].

3-6 Advanced Chipset Features

The Advanced Chipset Features Setup option is used to change the values of the chipset registers. These registers control most of the system options in the computer.

CMOS Setup Utility - Copyright(C) 1984-2003 Award Software

Advanced Chipset Features

> DRAM Timing Settings	Press Enter	Item Help
> AGP Timing Settings	Press Enter	
> PCI Timing Settings	Press Enter	Menu Level >
System BIOS Cacheable	Disabled	
Video RAM Cacheable	Disabled	
Memory Hole	Disabled	
↑↓→← Move Enter:Select +/-/PU/PD:Value F10:Save ESC:Exit F1:General Help F5:Previous Values F6:Optimized Defaults F7:Standard Defaults		

DRAM Timing Settings

Please refer to section 3-6-1

AGP Timing Settings

Please refer to section 3-6-2

PCI Timing Settings

Please refer to section 3-6-3

System BIOS Cacheable

Selecting Enabled allows caching of the system BIOS ROM at F0000h-FFFFFh, resulting in better system performance. However, if any program writes to this memory area, a system error may result. The settings are: Enabled and Disabled.

Video RAM Cacheable

Select Enabled allows caching of the video BIOS, resulting in better system performance. However, if any program writes to this memory area, a system error may result. The settings are: Enabled and Disabled.

Memory Hole

You can reserve this area of system memory for ISA adapter ROM. When this area is reserved, it cannot be cached. The user information of peripherals that need to use this area of system memory usually discusses their memory requirements. The settings are: Enabled and Disabled.

3-6-1 DRAM Timing Settings

CMOS Setup Utility - Copyright(C) 1984-2003 Award Software

DRAM Timing Settings

Auto Configuration	Standard	Item Help
RAS Active Time	6T	Menu Level >>
RAS Precharge Time	3T	
RAS to CAS Delay	3T	
CAS Latency	2.5T	
Bank Interleave	Disabled	
DRAM Command Rate	2T Command	
↑↓→← Move Enter:Select +/-/PU/PD:Value F10:Save ESC:Exit F1:General Help F5:Previous Values F6:Optimized Defaults F7:Standard Defaults		

RAS Active Time

This field let's you insert a timing delay between the CAS and RAS strobe signals, used when DRAM is written to, read from, or refreshed. *Fast* gives faster performance; and *Slow* gives more stable performance. This field applies only when synchronous DRAM is installed in the system. The settings are: 2T and 3T.

RAS Precharge Time

If an insufficient number of cycles is allowed for the RAS to accumulate its charge before DRAM refresh, the refresh may be incomplete and the DRAM may fail to retain data. *Fast* gives faster performance; and *Slow* gives more stable performance. This field applies only when synchronous DRAM is installed in the system. The settings are: 2T and 3T.

CAS Latency

When synchronous DRAM is installed, the number of clock cycles of CAS latency depends on the DRAM timing. The settings are: 2T and 2.5T.

3-6-2 AGP Timing Settings

CMOS Setup Utility - Copyright(C) 1984-2003 Award Software

AGP Timing Settings

AGP Transfer Aperture Size	64M	Item Help
AGP Mode	Auto	
AGP Driving Control	Auto	
* AGP Driving Value	DA	Menu Level >>
AGP Fast Write	Disabled	
AGP Master 1 WS Write	Enabled	
AGP Master 1 WS Read	Enabled	
CPU to AGP Post Write	Disabled	
AGP Delay Transaction	Disabled	
↑↓→← Move Enter:Select +/-/PU/PD:Value F10:Save ESC:Exit F1:General Help F5:Previous Values F6:Optimized Defaults F7:Standard Defaults		

Note: Change these settings only if you are familiar with the chipset.

3-6-3 PCI Timing Settings

CMOS Setup Utility - Copyright(C) 1984-2003 Award Software

PCI Timing Settings

PCI Master 1 WS Write	Disabled	Item Help
PCI Master 1 WS Read	Disabled	
CPU to PCI Write Buffer	Enabled	
PCI Delay Transaction	Disabled	Menu Level >>
↑ ↓ → ← Move Enter:Select +/-/PU/PD:Value F10:Save ESC:Exit F1:General Help F5:Previous Values F6:Optimized Defaults F7:Standard Defaults		

PCI Delay Transaction

The chipset has an embedded 32-bit posted write buffer to support delay transactions cycles. Select Enabled to support compliance with PCI specification version 2.1. The settings are: Enabled and Disabled.

3-7 Integrated Peripherals

CMOS Setup Utility - Copyright(C) 1984-2003 Award Software

Integrated Peripherals

> OnChip IDE Function	Press Enter	Item Help
> OnChip Device Function	Press Enter	
> Onboard Super IO Function	Press Enter	
Init Display First	PCI Slot	Menu Level >
↑↓→← Move Enter:Select +/-/PU/PD:Value F10:Save ESC:Exit F1:General Help F5:Previous Values F6:Optimized Defaults F7:Standard Defaults		

OnChip IDE Function

Please refer to section 3-7-1

OnChip Device Function

Please refer to section 3-7-2

Onboard Super IO Function

Please refer to section 3-7-3

Init Display First

This item allows you to decide to activate whether PCI Slot or AGP VGA first. The settings are: PCI Slot, AGP Slot.

3-7-1 OnChip IDE Function

CMOS Setup Utility - Copyright(C) 1984-2003 Award Software

OnChip IDE Function

OnChip IDE Channel0	Enabled	Item Help
OnChip IDE Channel1	Enabled	
Primary Master PIO	Auto	
Primary Slave PIO	Auto	
Secondary Master PIO	Auto	
Secondary Slave PIO	Auto	
Primary Master UDMA	Auto	
Primary Slave UDMA	Auto	
Secondary Master UDMA	Auto	
Secondary Slave UDMA	Auto	
IDE 32-bit Transfer Mode	Enabled	
IDE HDD Block Mode	Enabled	
IDE Prefetch Mode	Enabled	
Delay For HDD (Secs)	0	

↑↓→← Move Enter:Select +/-/PU/PD:Value F10:Save ESC:Exit F1:General Help
F5:Previous Values F6:Optimized Defaults F7:Standard Defaults

OnChip IDE Channal0/Channel1

The integrated peripheral controller contains an IDE interface with support for two IDE channels. Select *Enabled* to activate each channel separately. The settings are: Enabled and Disabled.

Primary/Secondary Master/Slave PIO

The four IDE PIO (Programmed Input/Output) fields let you set a PIO mode (0-4) for each of the four IDE devices that the onboard IDE interface supports. Modes 0 through 4 provide successively increased performance. In Auto mode, the system automatically determines the best mode for each device. The settings are: Auto, Mode 0, Mode 1, Mode 2, Mode 3, Mode 4.

Primary/Secondary Master/Slave UDMA

Ultra DMA/33 implementation is possible only if your IDE hard drive supports it and the operating environment includes a DMA driver (Windows 95 OSR2 or a third-party IDE bus master driver). If your hard drive and your system software both support Ultra DMA/33 and Ultra DMA/66, select Auto to enable BIOS support. The settings are: Auto, Disabled.

IDE HDD Block Mode

Block mode is also called block transfer, multiple commands, or multiple sector read/write. If your IDE hard drive supports block mode (most new drives do), select Enabled for automatic detection of the optimal number of block read/writes per sector the drive can support. The settings are: Enabled, Disabled.

3-7-2 OnChip Device Function

CMOS Setup Utility - Copyright(C) 1984-2003 Award Software

OnChip Device Function

AC97 Sound Device	Auto	Item Help
Game Port Address	201	
Midi Port Address	Disabled	
Midi Port IRQ	10	Menu Level >>
AC97 Modem Device	Auto	
USB Host Controller	Enabled	
USB Keyboard Legacy Support	Disabled	
↑↓→← Move Enter:Select +/-/PU/PD:Value F10:Save ESC:Exit F1:General Help F5:Previous Values F6:Optimized Defaults F7:Standard Defaults		

AC97 Sound Device

This item allows you to decide to enable/disable the chipset family to support AC97 Audio. The settings are: Enabled, Disabled.

Game Port Address/Midi Port Address

This will determine which Address the Game Port/Midi Port will use.

AC97 Modem Device

This item allows you to decide to enable/disable the chipset family to support AC97 Modem. The settings are: Auto, Disabled.

USB Host Controller

Select *Enabled* if your system contains a Universal Serial Bus (USB) controller and you have a USB peripherals. The settings are: Enabled, Disabled.

USB Keyboard Support

Select *Enabled* if your system contains a Universal Serial Bus (USB) controller and you have a USB keyboard. The settings are: Enabled, Disabled.

3-7-3 Onboard Super IO Function

Onboard Super IO Function

Onboard FDD Controller	Enabled	Item Help
Onboard Serial Port 1	3F8/IRQ4	
Onboard Serial Port 2	2F8/IRQ3	Menu Level >>
UART2 Mode	Normal	
RxD, TxD Active	Hi, Lo	
IR Duplex Mode	Half	
Use IR Pins	IRRX/IRTX	
Onboard Parallel Port	378/IRQ7	
Parallel Mode	SPP	
EPP Mode Select	EPP1.7	
ECP Mode Use DMA	3	
↑↓→← Move Enter:Select +/-/PU/PD:Value F10:Save ESC:Exit F1:General Help F5:Previous Values F6:Optimized Defaults F7:Standard Defaults		

Onboard FDD Controller

Select Enabled if your system has a floppy disk controller (FDD) installed on the system board and you wish to use it. If you install add-on FDC or the system has no floppy drive, select Disabled in this field. The settings are: Enabled and Disabled.

Onboard Serial Port 1/Port 2

Select an address and corresponding interrupt for the first and the second serial ports. The settings are: 3F8/IRQ4, 2E8/IRQ3, 3E8/IRQ4, 2F8/IRQ3, Disabled, Auto.

UART2 Mode

This item allows you to determine which InfraRed(IR) function of the onboard I/O chip, this functions uses.

Onboard Parallel Port

There is a built-in parallel port on the on-board Super I/O chipset that Provides Standard, ECP, and EPP features. It has the following option:

Disabled

- (3BCH/IRQ7)/ Line Printer port 0
- (278H/IRQ5)/ Line Printer port 2
- (378H/IRQ7) Line Printer port 1

Parallel Port Mode

- SPP : Standard Parallel Port
- EPP : Enhanced Parallel Port
- ECP : Extended Capability Port

SPP/EPP/ECP/ECP+EPP

To operate the onboard parallel port as Standard Parallel Port only, choose "SPP." To operate the onboard parallel port in the EPP modes simultaneously, choose "EPP." By choosing "ECP", the onboard parallel port will operate in ECP mode only. Choosing "ECP+EPP" will allow the onboard parallel port to support both the ECP and EPP modes simultaneously. The ECP mode has to use the DMA channel, so choose the onboard parallel port with the ECP feature. After selecting it, the following message will appear: "ECP Mode Use DMA" at this time, the user can choose between DMA channels 3 to 1. The onboard parallel port is EPP Spec. compliant, so after the user chooses the onboard parallel port with the EPP function, the following message will be displayed on the screen: "EPP Mode Select." At this time either EPP 1.7 spec. or EPP 1.9 spec. can be chosen.

3-8 Power Management Setup

The Power Management Setup allows you to configure your system to most effectively save energy saving while operating in a manner consistent with your own style of computer use.

CMOS Setup Utility - Copyright(C) 1984-2003 Award Software

Power Management Setup

ACPI Function	Enabled	Item Help
Video Off Option	Always off	
Video off Method	V/H SYNC+Blank	
MODEM Use IRQ	3	Menu Level >
Power Button Function	Instant-Off	
Power After Power Failure	Off	
> Wake Up Events	Press Enter	
<p>↑↓→← Move Enter:Select +/-/PU/PD:Value F10:Save ESC:Exit F1:General Help F5:Previous Values F6:Optimized Defaults F7:Standard Defaults</p>		

ACPI Function

This item allows you to Enabled/Disabled the Advanced Configuration and Power Management (ACPI). The settings are Enabled and Disabled.

Video Off Option

This determines the manner in which the monitor is blanked. The choice are Suspend → off, All Modes → Off, and Always On.

Video Off Method

This determines the manner in which the monitor is blanked.

- DPMS (default)** Initial display power management signaling.
- Blank Screen** This option only writes blanks to the video buffer.
- V/H SYNC+Blank** This selection will cause the system to turn off the vertical and horizontal synchronization ports and write blanks to the video buffer.

Modem Use IRQ

This determines the IRQ in which the MODEM can use.

The settings are: 3, 4, 5, 7, 9, 10, 11, NA.

Power Button Function

Pressing the power button for more than 4 seconds forces the system to enter the Soft-Off state. The settings are: Delay 4 Sec, Instant-Off.

Wake Up Events

Please refer to section 3-8-1

3-8-1 Wake up Events

Wake Up Events

VGA	OFF	Item Help	
LPT & COM	LPT/COM		
HDD & FDD	ON	Menu Level >>	
PCI Master	OFF		
Wake-Up on Ring/LAN	Disabled		
Wake-Up on PCI PME	Disabled		
Wake-Up on RTC Alarm	Disabled		
x Date of Month Alarm	0		
x Time (hh:mm:ss) Alarm	0 : 0 : 0		
> IRQs Activities	Press Enter		
↑↓→← Move Enter:Select +/-/PU/PD:Value F10:Save ESC:Exit F1:General Help F5:Previous Values F6:Optimized Defaults F7:Standard Defaults			

Wake Up On Ring/PME

During Disabled, the system will ignore any incoming call from the modem. During Enabled, the system will boot up if there's an incoming call from the modem.

Wake-Up on RTC Alarm

This function is for setting date and time for your computer to boot up. During Disabled, you cannot use this function. During Enabled, choose the Date and Time Alarm:

Date(of month) Alarm

You can choose which month the system will boot up. Set to 0, to boot every day.

Time(hh:mm:ss) Alarm

You can choose what hour, minute and second the system will boot up.

Note: If you have change the setting, you must let the system boot up until it goes to the operating system, before this function will work.

IRQs Activities

Please refer to section 3-8-1.1

3-8-1.1 IRQs Activities

IRQs Activities

Primary INTR	ON	Item Help	
IRQ3 (COM 2)	Enabled		
IRQ4 (COM 1)	Enabled	Menu Level >>>	
IRQ5 (LPT 2)	Enabled		
IRQ6 (Floppy Disk)	Enabled		
IRQ7 (LPT 1)	Enabled		
IRQ8 (RTC Alarm)	Disabled		
IRQ9 (IRQ2 Redir)	Disabled		
IRQ10 (Reserved)	Disabled		
IRQ11 (Reserved)	Disabled		
IRQ12 (PS/2 Mouse)	Enabled		
IRQ13 (Coprocessor)	Disabled		
IRQ14 (Hard Disk)	Enabled		
IRQ15 (Reserved)	Disabled		
↑↓→← Move Enter:Select +/-/PU/PD:Value F10:Save ESC:Exit F1:General Help F5:Previous Values F6:Optimized Defaults F7:Standard Defaults			

3-9 PnP/PCI Configuration Setup

This section describes configuring the PCI bus system. PCI, or **Personal Computer Interconnect**, is a system which allows I/O devices to operate at speeds nearing the speed the CPU itself uses when communicating with its own special components. This section covers some very technical items and it is strongly recommended that only experienced users should make any changes to the default settings.

CMOS Setup Utility - Copyright(C) 1984-2003 Award Software

PnP/PCI Configurations

PnP OS Installed	No	Item Help
Reset Configuration Data	Disabled	
Resources Controlled By	Manual	Menu Level >
x IRQ Resources	Press Enter	
PCI/VGA Palette Snoop	Disabled	
Assign IRQ For VGA	Enabled	
Assign IRQ For USB	Enabled	
↑↓→← Move Enter:Select +/-/PU/PD:Value F10:Save ESC:Exit F1:General Help F5:Previous Values F6:Optimized Defaults F7:Standard Defaults		

Reset Configuration Data

Normally, you leave this field Disabled. Select Enabled to reset Extended System Configuration Data (ESCD) when you exit Setup if you have installed a new add-on and the system reconfiguration has caused such a serious conflict that the operating system can not boot. The settings are: Enabled and Disabled.

Resource Controlled By

The Award Plug and Play BIOS has the capacity to automatically configure all of the boot and Plug and Play compatible devices. However, this capability means absolutely nothing unless you are using a Plug and Play operating system such as Windows®95/98. If you set this field to “manual” choose specific resources by going into each of the sub menu that follows this field (a sub menu is preceded by a “>”).

The settings are: Auto(ESCD), Manual.

IRQ Resources

When resources are controlled manually, assign each system interrupt a type, depending on the type of device using the interrupt.

Please refer to section 3-9-1

PCI/VGA Palette Snoop

Leave this field at *Disabled*. The settings are Enabled, Disabled.

3-9-1 IRQ Resources

IRQ Resources

IRQ3	assigned to	PCI Device	Item Help
IRQ4	assigned to	PCI Device	
IRQ5	assigned to	PCI Device	Menu Level >>
IRQ7	assigned to	PCI Device	
IRQ9	assigned to	PCI Device	
IRQ10	assigned to	PCI Device	
IRQ11	assigned to	PCI Device	
IRQ12	assigned to	PCI Device	
IRQ14	assigned to	PCI Device	
IRQ15	assigned to	PCI Device	
↑↓→← Move Enter:Select +/-/PU/PD:Value F10:Save ESC:Exit F1:General Help F5:Previous Values F6:Optimized Defaults F7:Standard Defaults			

3-10 PC Health Status

This section shows the Status of you CPU, Fan, Warning for overall system status. This is only available if there is Hardware Monitor onboard.

PC Health Status

Shutdown Temperature	Disabled	Item Help
CPU Warning Temperature	Disabled	
Show PC Health in Post	Enabled	Menu Level >
Current System Temperature	25°C	
Current CPU Temperature	38°C	
CPUFAN	5000 rpm	
SYSFAN	5000 rpm	
Vcore	1.78V	
Vcc3.3	3.31V	
+ 5V	4.98V	
+12V	12.22V	
-12V	-12.36V	
-5V	-5.09V	
VBAT(V)	3.21V	
5VSB(V)	5.02V	
↑↓→← Move Enter:Select +/-/PU/PD:Value F10:Save ESC:Exit F1:General Help F5:Previous Values F6:Optimized Defaults F7:Standard Defaults		

Shutdown Temperature

This item can let users setting the Shutdown temperature, when CPU temperature over this setting the system will auto shutdown to protect CPU.

Show PC Health in Post

During Enabled, it displays information list below. The choice is either Enabled or Disabled

Current CPU Temperature/Current System Temp/Current FAN1, FAN2 Speed/Vcore/Vdd/3.3V/+5V/+12V/-12V/VBAT(V)/5VSB(V)

This will show the CPU/FAN/System voltage chart and FAN Speed.

Detect CPUFAN in Post

During Enabled, system will warn the user if CPU Fan is not functioning.

3-11 Miscellaneous Control

This section is for setting CPU Frequency/Voltage Control.

CMOS Setup Utility - Copyright(C) 1984-2003 Award Software

Miscellaneous Control

CPU Clock Ratio	8X	Item Help
Auto Detect DIMM/PCI Clk	Enabled	Menu Level >
Spread Spectrum	Disabled	
** Current Host/PCI Clock is 100/33MHz **		
Host/PCI Clock at Next Boot is	100/33MHz	
** Current DRAM Clock is 133MHz **		
DRAM Clock at next Boot is	133MHz	
AGP VddQ Select	1.5V (Default)	
+2.5V Select	2.5V (Default)	
VDIMM Select	Default	
↑↓→← Move Enter:Select +/-/PU/PD:Value F10:Save ESC:Exit F1:General Help F5:Previous Values F6:Optimized Defaults F7:Standard Defaults		

Auto Detect DIMM/PCI Clk

This item allows you to enable/disable auto detect DIMM/PCI Clock.

Spread Spectrum

This item allows you to set the CPU Host/PCI clock and Spread Spectrum.

The settings are: Enabled, Disabled.

Host/PCI Clock at next Boot is

This item allows you to select CPU frequency step by step increasing

The choice are: 100MHz~132MHz, 133MHz~200MHz.

DRAM Clock at next Boot is

This field displays the capability of the memory modules that you can use

The choice is either 100MHz or 133MHz (only select CPU Frequency 100MHz.)

AGP VddQ Select

This item allows you to select 1.5V of the AGP 4X VGA card. The choice are: 1.5V, 1.6V.

VDIMM Select

This item allows you to select 2.5V of the DDR Module. The choice are: 2.5V, 2.6V, 2.7V, 2.8V.

3-12 Load Standard/Optimized Defaults

Load Standard Defaults

When you press <Enter> on this item, you get confirmation dialog box with a message similar to:

Load Standard Defaults (Y/N)? N

Pressing <Y> loads the BIOS default values for the most stable, minimal-performance system operations.

Load Optimized Defaults

When you press <Enter> on this item, you get a confirmation dialog box with a message similar to:

Load Optimized Defaults (Y/N)? N

Pressing <Y> loads the default values that are factory settings for optimal performance system operations.

3-13 Set Supervisor/User Password

You can set either supervisor or user password, or both of them. The differences are:

Supervisor password: Can enter and change the options of the setup menus.

User password: Can only enter but do not have the right to change the options of the setup menus. When you select this function, the following message will appear at the center of the screen to assist you in creating a password.

ENTER PASSWORD:

Type the password, up to eight characters in length, and press <Enter>. The password typed now will clear any previously entered password from CMOS memory. You will be asked to confirm the password. Type the password again and press <Enter>. You may also press <Esc> to abort the selection and not enter a password.

To disable a password, just press <Enter> when you are prompted to enter the password. A message will confirm that the password will be disabled. Once the password is disabled, the system will boot and you can enter Setup freely.

PASSWORD DISABLED.

When a password has been enabled, you will be prompted to enter it every time you try to enter Setup. This prevents an unauthorized person from changing any part of your system configuration.

Additionally, when a password is enabled, you can also require the BIOS to request a password every time your system is rebooted. This would prevent unauthorized use of your computer.

You determine when the password is required within the BIOS Features Setup Menu and its Security option. If the Security option is set to “System”, the password will be required both at boot and at entry to Setup. If set to “Setup”, prompting only occurs when trying to enter Setup.

Chapter 4

DRIVER & FREE PROGRAM INSTALLATION

Check your package and there is A MAGIC INSTALL CD included. This CD consists of all DRIVERS you need and some free application programs and utility programs. In addition, this CD also include an auto detect software which can tell you which hardware is installed, and which DRIVERS needed so that your system can function properly. We call this auto detect software MAGIC INSTALL.

MAGIC INSTALL supports WINDOWS 9X/ME/NT4.0/2000/XP

Insert CD into your CD-ROM drive and the MAGIC INSTALL Menu should appear as below. If the menu does not appear, double-click MY COMPUTER / double-click CD-ROM drive or click START / click RUN / type X:\SETUP.EXE (assuming X is your CD-ROM drive).



From MAGIC INSTALL MENU you may make 11 selections:

1. VIA 4 IN 1 install VIA Service Pack 4 IN 1 driver
2. VGA install VIA VGA driver
3. SOUND install ALC /CMI Audio Codec driver
4. LAN install VIA 10/100MB LAN Controller driver
(for P4MFP533/P4MFP533T)
5. USB2.0 install USB 2.0 driver
(for P4XFMU/P4MFMU/P4MFU533/P4MFP533/P4MFU533T/P4MFP533T)
6. DIRECTX8 install Microsoft DirectX 8.1 driver
7. PC-CILLIN install PC-CILLIN2002 anti-virus program
8. PC-HEALTH install Winbond PC-HEALTH hardware monitor Software
9. MAGIC BIOS install BIOS Live Update Utility
10. BROWSE CD to browse the contents of the CD
11. EXIT to exit from MAGIC INSTALL menu

4-1 IDE Install VIA Service Pack 4 IN 1 Driver

* The path of the file is X:\VIA\DRIVER\SETUP.EXE

- IDE :** VIA ATAPI VENDOR SUPPORT DRIVER IS USED TO FIXED COMPATIBILITY ISSUE FOR IDE DEVICES
- AGPVXD :** VIA AGPVXD DRIVER IS TO BE INSTALLED, IF YOU ARE USING AN AGP VGA CARD, VIAGART.VXD WILL PROVIDE SERVICE ROUTINES TO YOUR VGA DRIVER AND INTERFACE DIRECTLY TO HARDWARE, PROVIDING FAST GRAPHIC ACCESS
- IRQ ROUTING :** VIA PCI IRQ MINIPOINT DRIVER IS TO BE INSTALLED UNDER WIN98 ONLY, IT WILL FIX PCI IRQ ROUTING SEQUENCE
- INF :** VIA REGISTRY DRIVER IS TO BE INSTALLED UNDER WINDOWS THE DRIVER WILL ENABLE VIA POWER MANAGERMENT CONTROLLER



1. Click IDE when MAGIC INSTALL MENU appears



2. Click NEXT when VIA Service Pack Wizard appears

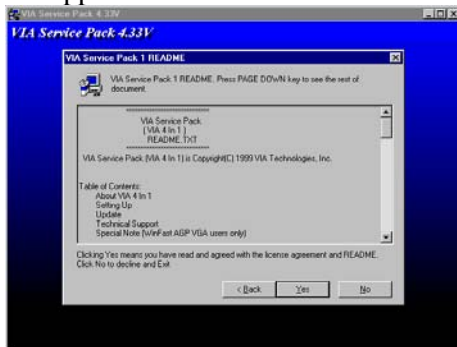

3. This is to announce the Copy Write, click Yes



4. Click NEXT to choose all driver

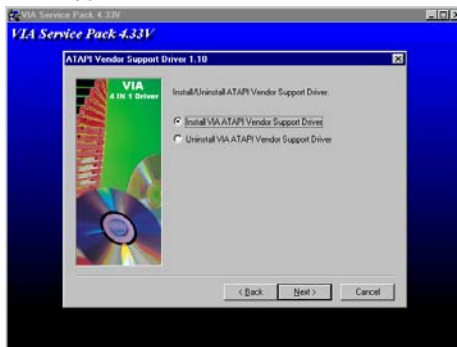

5. Click NEXT to Install ATAPI Vender Support Driver

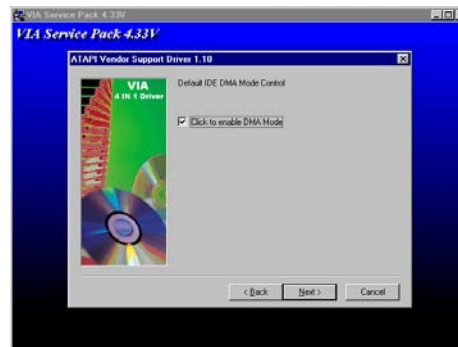

6. Click NEXT to choose enabled DMA Mode Driver

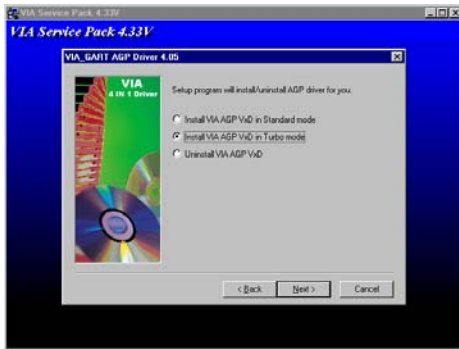

7. Click NEXT to Install VIA AGP VXD Driver

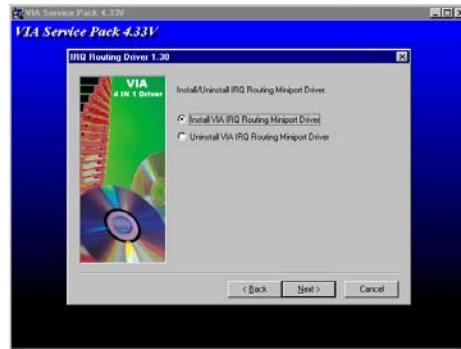

8. Click NEXT to Install VIA IRQ Routing Mini port Driver

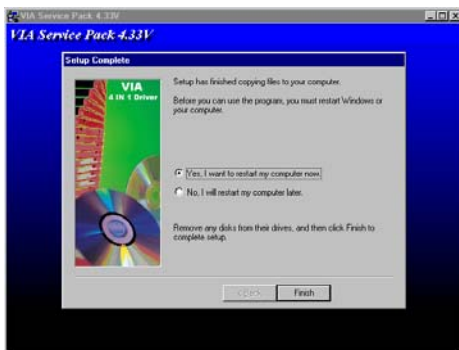

9. Click Finish to restart computer

4-2 VGA install VIA P4M266 VGA Driver

A. For WINDOWS 9X/ME/NT4.0/2000/XP



1. Click VGA when MAGIC INSTALL MENU appears



2. Click NEXT When ProSavageDDR Driver Install Setup Wizard Appears



3. Click NEXT to Install Driver File

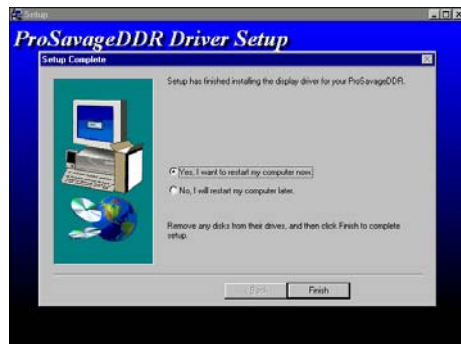

4. Click Finish to Restart Computer

4-3 SOUND Install ALC/CMI Audio Codec Driver

4-3-1 SOUND Install ALC Audio Codec Driver



1. Click SOUND when MAGIC INSTALL MENU appears

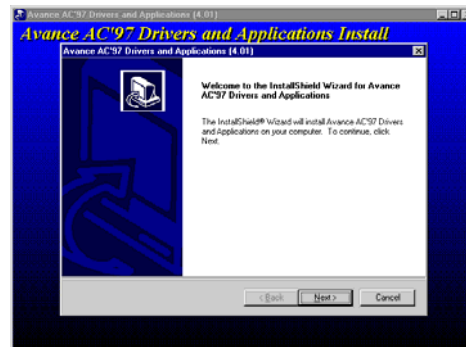

2. Then auto detect operation system language edition, click OK, start to install DRIVER

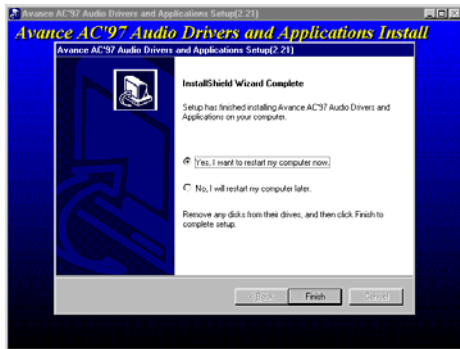

3. Click Finish and Restart Windows

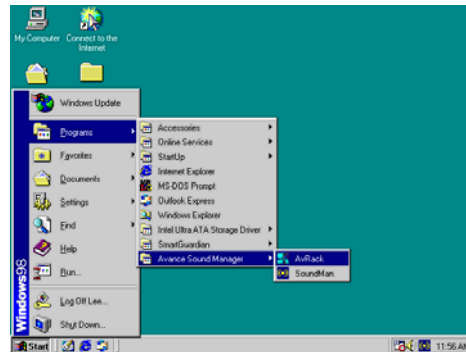

4. Click Start→Program→Avance Sound Manager→AvRack. Then AVRACK Windows appears

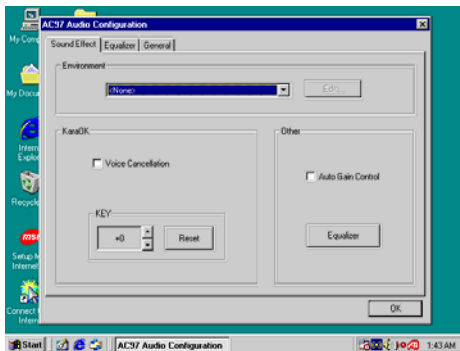

5. Sound Effect select and Karaoke Mode Function

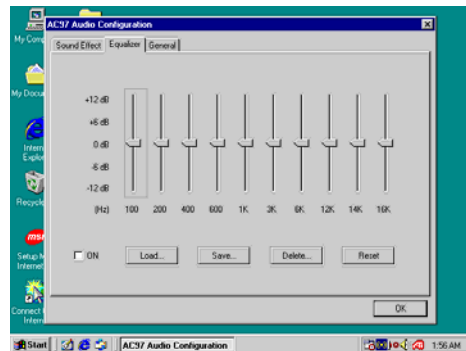

6. Manual Sound Effect Setting

Note: The path of the file

For WIN98/NT4.0/WIN2K is X:\CODEC\ALCCODEC\SETUP.EXE

For WIN95 is X:\VIA\VIAAUDIO\SETUP.EXE

For Linux is X:\VIA\VIAAUDIO\Linux

For Real DOS Mode is X:\VIA\VIAAUDIO\VIADOS

4-3-2 SOUND Install CMI Audio Codec Driver



3. Click SOUND when MAGIC INSTALL MENU appears



4. Choose Install component in Installation Package



3. Click Next when copyright Issue appears, click Next or choose BROWSE to change the path for the file to be store



4. Enter Program folders name or click Next

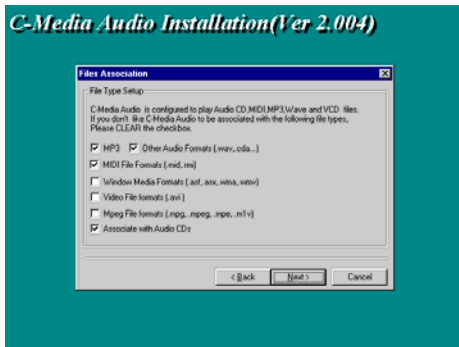

5. C-Media Media Rack can Auto Play following Format file choose need component and Click Next



6. Click Next when Start copying files windows appears, OS can Auto Find C-Media AC97 Audio Device Click Next

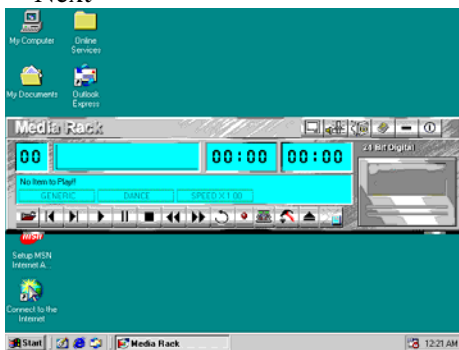

7. C-Media Media Rack Play table



8. C-Media Audio Configuration setting



9. C-Media Multi-Channel Audio Demo Program, you can Test speaker position

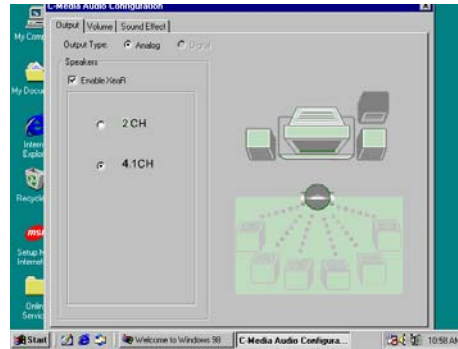

10. When Enabled XeaR, you can plug earphone in Speak-Out connector as a Rear speaker, and 2-channel speaker plug in Line-In as Front Speaker to get 4-channel effect

4-4 LAN Install VIA 10/100MB LAN Controller Driver (for P4MFP533/P4MFP53T)

The VIA 10/100MB PCI Ethernet Adapter Driver path is X:\VIA\LANDRV



1. Click LAN when Magic Install Menu appear

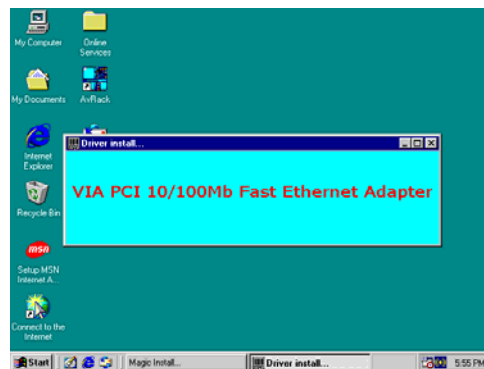

2. Setup VIA 10/100Mb PCI Ethernet Driver

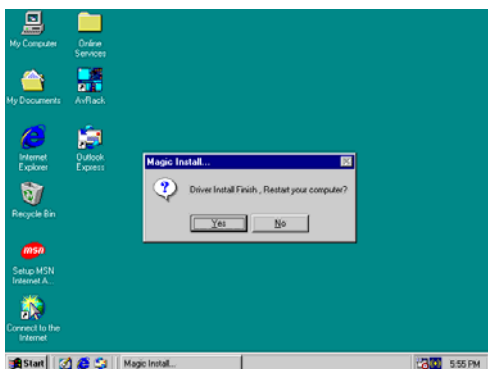

3. Driver install Finish, Click Yes and Restart Computer

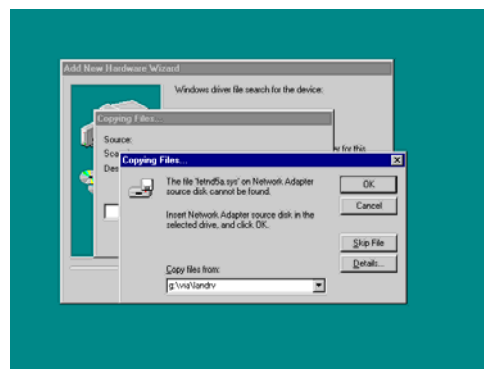

4. When windows ask VIA 10/100Mb PCI Ethernet Adapter driver path, Change directory to X:\VIA\LANDRV and click OK, then finish installation

4-5 PC-HEALTH Winbond Hardware Doctor Monitoring Software

The path of the file is X:\VIA\HEALTH-W\SETUP.EXE

(Support Windows 9X/ME/2K/NT/XP)

In Windows 95/98 Winbond Hardware Doctor Monitoring Software needs some system files to copy in Utility that's why it needs install PC-HEALTH twice to complete setup.



1. Click PC-Health when Magic Install Menu appears



2. Click OK when Winbond Hardware Doctor Setup Window appears



3. Click the Button to start installation



4. Select Program Group name or enter a new group name, click continue to setup and click OK after setup complete

4-5-1 How To Utilize PC-HEALTH



1. Click Program → Winbond Hardware Doctor → Hardware Doctor the Winbond Hardware Doctor will appears
You can remove the Utility in Control Panel → Add/Remove Program icon

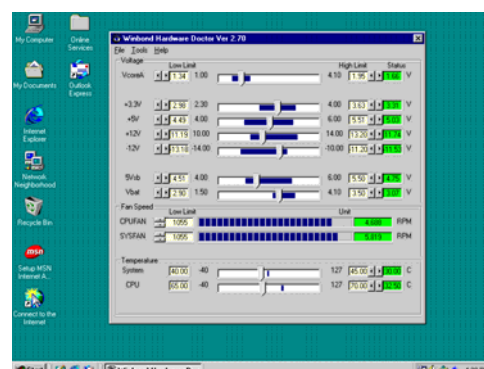

2. After executing Winbond Hardware Doctor it supports system voltage, Fan speed and CPU/ SYSTEM Temperature. Because this is a On-time Monitoring program therefore the value will change after it detected, if the value is over default setting the system will have warning picture and beeps

4-6 MAGIC BIOS Install BIOS Live Update Utility

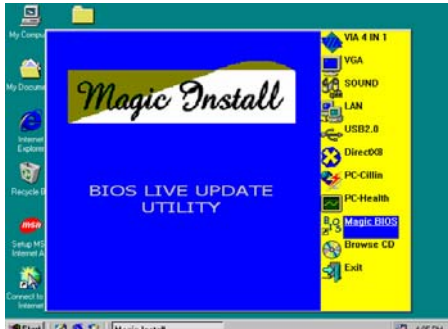

1. Click Magic BIOS when Magic Install MENU appears



3. After finish Setup you will have a Magic BIOS icon in your screen

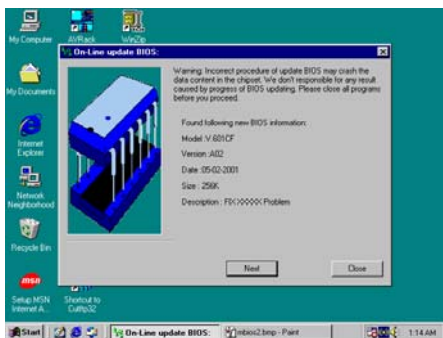

5. When On-line update BIOS the program will auto-check your BIOS version

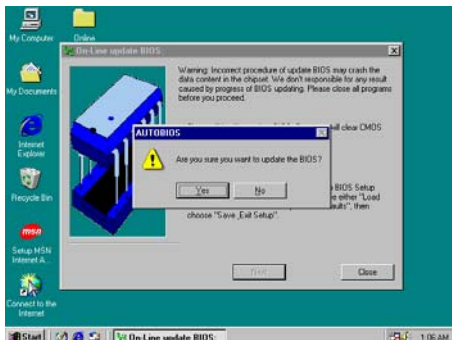

7. Click Yes if you want to update the BIOS otherwise choose No to exit



2. Click Next to install the Magic BIOS in Destination Folder

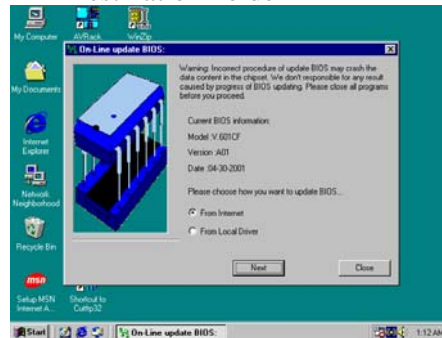

4. Double click the Magic BIOS icon you will have this picture, choose from internet you can upgrade BIOS On-line



6. Click Next if you need update BIOS, after upgrade BIOS, the system will clear CMOS and automatically restart

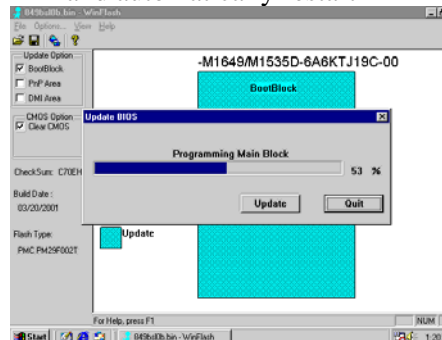

8. When System programming BIOS don't turn off power, after finish update BIOS, the system will clear CMOS and automatically Restart

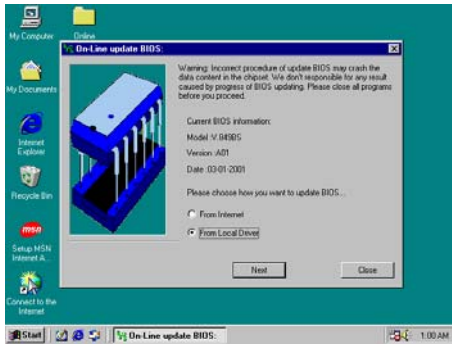

9. When choose From Local Driver to update BIOS, you must have the correct BIOS file in your Local Driver



10. Choose the correct BIOS file to update BIOS

4-7 USB2.0 Install VIA USB2.0 Device Drive (for P4XFMU/P4MFMU/P4MFU533/P4MFP533/P4MFU533T/P4MFP533T)



1. Click USB2.0 when MAGIC INSTALL MENU Appear



2. When USB2.0 Setup Program Appear, Click NEXT



3. Select Install USB Driver and Click NEXT



4. Select FINISH and Restart your Computer

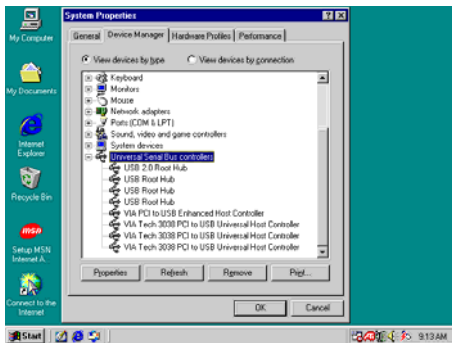

5. Check device working properly in Device Manager

The Path of the file is X:\VIA\VIAUSB20\SETUP.EXE

4-8 PC-CILLIN Install PC-CILLIN 2002 Anti-virus program

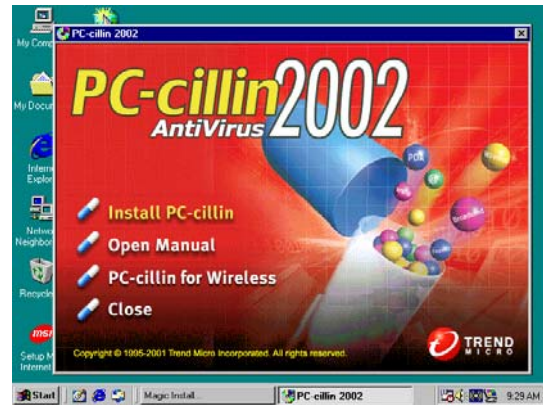

1. Click PC-CILLIN when MAGIC INSTALL MENU appear
2. (1) Click "Install PC-CILLIN" when PC-CILLIN 2002 main menu appears, and Click NEXT when "Install Shield Wizard For PC-CILLIN 2002"
(2) Click Open Manual. you can learn PC-CILLIN 2002 how to use

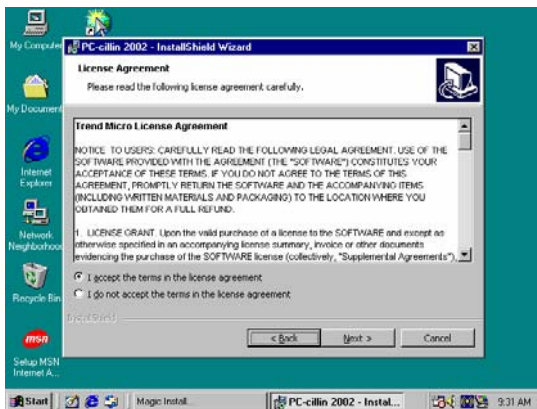

3. This is license agreement, select "I Accept the terms" and Click NEXT
4. Click NEXT and Enter your Customer Information, Click NEXT or choose Change to change the path for the file to be stored

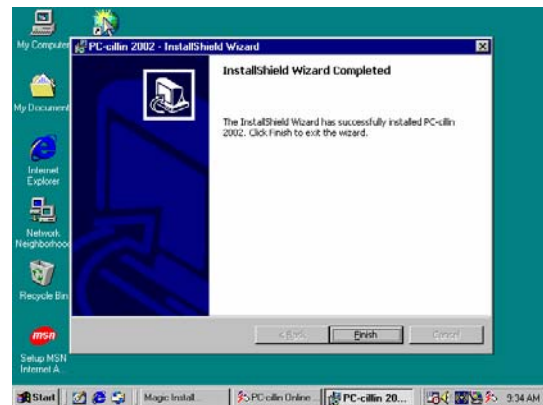
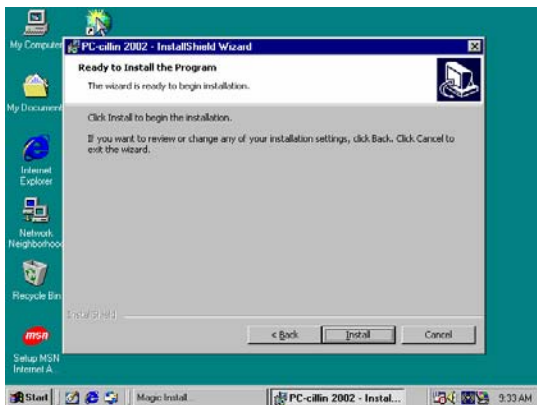

5. Click INSTALL, Start to install the software
6. Setup Complete and click FINISH

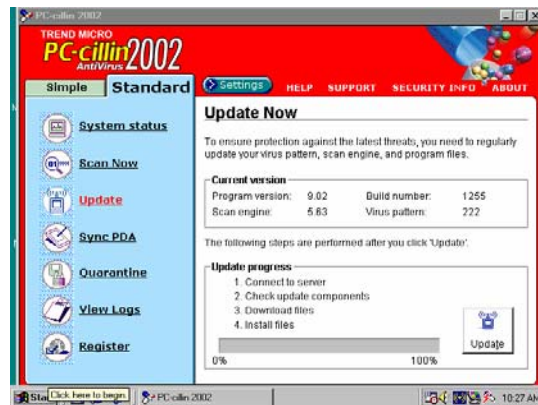
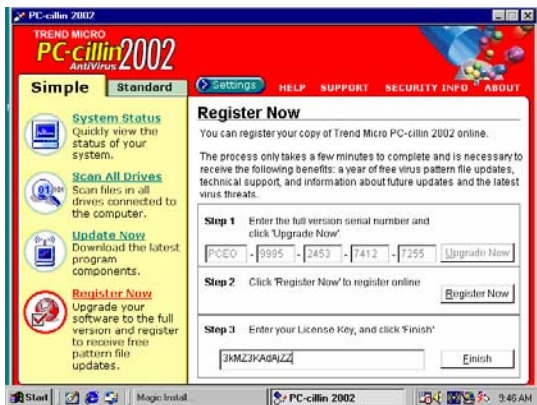

7. After PC-CILLIN 2002 complete, Please register your information and get LICENSE KEY from TREND MICRO web site, enter your license key and click FINISH

8. finish register process, we recommend select update item to download newest engine code and virus code

Note : Please install ACROBAT READER, Before you read PC-CILLIN 2002 User Manual, the path at X:\acrobat\ar500eng.exe

4-9 HOW TO DISABLE ON-BOARD SOUND

Enter BIOS SETUP choose INTEGRATE PERIPHERALS choose ON-CHIP DEVICE FUNCTION choose AC97 SOUND DEVICE

Disable on-board sound function by press PAGE DOWN KEY to Disable

4-10 HOW TO UPDATE BIOS

Before update BIOS please choose Disabled in “Flash Part Write Protect” item on “Miscellaneous Control” in BIOS Setup, please refer page 34

Method 1. Use “Magic BIOS” update BIOS in Windows 98 (refer page 43)

Method 2. In DOS Mode

STEP 1. Prepare a boot disc. (you may make one by click START click RUN type SYS A: click OK)

STEP 2. Copy utility program to your boot disc. You may copy from DRIVER CD X:\FLASH\AWDFLASH.EXE or download from our web site.

STEP 3. Copy latest BIOS for P4XFM/P4XFMU/P4MFM/P4MFMU/P4MFU533/P4MFP533/P4MFU533T/P4MFP533T from our web site to your boot disc.

STEP 4. Insert your boot disc into A:;

start the computer, type “Awdflash A:\ P4XFMAxxx.BIN /SN/PY/CC/R”
P4XFMAxxx.BIN is the file name of latest BIOS it can be P4XFMA3.BIN or P4XFMB2.BIN

SN means don't save existing BIOS data

PY means renew existing BIOS data

CC means clear existing CMOS data

R means restart computer

STEP 5. Push ENTER and the BIOS will be updated, computer will be restarted automatically.