

Preface

Copyright

This publication, including all photographs, illustrations and software, is protected under international copyright laws, with all rights reserved. Neither this manual, nor any of the material contained herein, may be reproduced without written consent of the author.

Version 1.0

Disclaimer

The information in this document is subject to change without notice. The manufacturer makes no representations or warranties with respect to the contents hereof and specifically disclaims any implied warranties of merchantability or fitness for any particular purpose. The manufacturer reserves the right to revise this publication and to make changes from time to time in the content hereof without obligation of the manufacturer to notify any person of such revision or changes.

Trademark Recognition

Microsoft, MS-DOS and Windows are registered trademarks of Microsoft Corp.

MMX, Pentium, Pentium-II, Pentium-III, Celeron are registered trademarks of Intel Corporation.

Other product names used in this manual are the properties of their respective owners and are acknowledged.

Federal Communications Commission (FCC)

This equipment has been tested and found to comply with the limits for a Class B digital device, pursuant to Part 15 of the FCC Rules. These limits are designed to provide reasonable protection against harmful interference in a residential installation. This equipment generates, uses, and can radiate radio frequency energy and, if not installed and used in accordance with the instructions, may cause harmful interference to radio communications. However, there is no guarantee that interference will not occur in a particular installation. If this equipment does cause harmful interference to radio or television reception, which can be determined by turning the equipment off and on, the user is encouraged to try to correct the interference by one or more of the following measures:

- Reorient or relocate the receiving antenna.
- Increase the separation between the equipment and the receiver.
- Connect the equipment onto an outlet on a circuit different from that to which the receiver is connected.
- Consult the dealer or an experienced radio/TV technician for help.

Shielded interconnect cables and a shielded AC power cable must be employed with this equipment to ensure compliance with the pertinent RF emission limits governing this device. Changes or modifications not expressly approved by the system's manufacturer could void the user's authority to operate the equipment.

Declaration of Conformity

This device complies with part 15 of the FCC rules. Operation is subject to the following conditions:

- This device may not cause harmful interference, and
- This device must accept any interference received, including interference that may cause undesired operation.

Canadian Department of Communications

This class B digital apparatus meets all requirements of the Canadian Interference-causing Equipment Regulations.

Cet appareil numérique de la classe B respecte toutes les exigences du Règlement sur le matériel brouilleur du Canada.

About the Manual

The manual consists of the following:

Chapter 1 Introducing the Mainboard	Describes features of the mainboard, and provides a shipping checklist. Go to ⇒ page 1
Chapter 2 Installing the Mainboard	Describes installation of mainboard components. Go to ⇒ page 6
Chapter 3 Using BIOS	Provides information on using the BIOS Setup Utility. Go to ⇒ page 23
Chapter 4 Using the Mainboard Software	Describes the mainboard software. Go to ⇒ page 43

TABLE OF CONTENTS

Preface	i
Features and Packing List Translations	錯誤! 尚未定義書籤。
CHAPTER 1	1
Introducing the Mainboard	1
<i>Introduction</i>	1
<i>Checklist</i>	1
Standard Items	1
<i>Features</i>	2
<i>Choosing a Computer Case</i>	3
<i>Mainboard Components</i>	4
CHAPTER 2	6
Installing the Mainboard	6
<i>Safety Precautions</i>	6
<i>Quick Guide</i>	6
<i>Installing the Mainboard in a Case</i>	7
<i>Checking Jumper Settings</i>	7
Setting Jumpers	7
Checking Jumper Settings.....	8
Jumper Settings	8
<i>Connecting Case Components</i>	9
The Panel Connectors.....	9
<i>Installing Hardware</i>	10
Installing the Processor.....	10
Installing Memory Modules	13
Installing a Hard Disk Drive/CD-ROM	14
Installing a Floppy Diskette Drive	15
Installing Add-on Cards	16
Connecting Optional Devices.....	17
<i>Connecting I/O Devices</i>	21
External Connector Color Coding.....	22
CHAPTER 3	23
Using BIOS	23
<i>About the Setup Utility</i>	23
The Standard Configuration.....	23
Entering the Setup Utility.....	24
Updating the BIOS.....	24
<i>Using BIOS</i>	25
Standard CMOS Features.....	26
Advanced BIOS Setup Option	28

Advanced Chipset Features Option.....	30
Integrated Peripherals Option.....	32
Power Management Setup Option.....	35
PNP/PCI Configuration Option.....	37
PC Health Status Option.....	39
Frequency/Voltage Control.....	39
Load Fail-Safe Defaults Option	40
Load Optimized Defaults Option	41
Set Password Option	41
Save & Exit Setup Option	41
Exit Without Saving	42

CHAPTER 4 **43**

Using the Mainboard Software	43
<i>About the Software CD-ROM</i>	43
<i>Auto-installing under Windows 98</i>	43
Running Setup.....	44
<i>Utility Software Reference</i>	46

Chapter 1

Introducing the Mainboard

Introduction

Congratulations on purchasing the P4IBAD mainboard. The P4IBAD mainboard is an ATX mainboard that uses a 4-layer printed circuit board and measures 304 mm x 244 mm. The mainboard features a mPGA478 Socket that accommodates Intel Pentium 4 processors supporting system speeds up to 400 MHz and data bus bandwidths up to 3.2 GB/s.

The P4IBAD incorporates the Intel i82845 (MCH) and the Intel 82801BA (ICH2) chipsets, which supports 2.5V DDR DRAM, 2X/4X AGP (1.5V only), and the AC' 97 codec.

Checklist

Compare the mainboard's package contents with the following checklist:

Standard Items

- One mainboard
- One diskette drive ribbon cable
- One IDE drive ribbon cable
- Retention Module Clamp
- Software support CD
- This user's manual

Features

Processor	<p>The P4IBAD mainboard uses a mPGA478 Socket that has the following features:</p> <ul style="list-style-type: none"> • Accommodates Intel Pentium 4 478-pins CPU • Supports a system bus of 400 MHz • Supports 3.2 GB/s data bus bandwidth
Chipset	<p>Intel's innovative i82845 (MCH) and 82801BA (ICH2) chipsets are based on an innovative and scalable architecture with proven reliability and performance. A few of the advanced features of the chipsets are:</p> <ul style="list-style-type: none"> • Host interface controller supports 400 MHz frontside (system) bus frequency • Supports 133 MHz SDR SDRAM or 266 MHz DDR SDRAM devices. • Supports a max of 2 Double-Sided DIMMs (4 rows populated) with unbuffered DDR266 (w / or w/out ECC). • Supports a maximum memory bandwidth of 1.6 GB/s with DDR266. • AGP controller is AGP 2.0 compliant and supports 2x/4x Fast Write Protocol (1.5V only) • PCI IDE controller supports PCI bus mastering, PIO modes 0-4, and UDMA 33/66/100 • Two USB controllers double the bandwidth to 24 Mbps across four ports • Integrated AC 97 audio that supports full surround sound with up to six channels <p>Additional key features include support for an AC 97 link for audio and modem, hardware monitoring, and ACPI/OnNow power management.</p>
Memory	<p>The mainboard can accommodate 2.5V DDR SDRAM. It accommodates two unbuffered 2.5V 184 pin slots with a total maximum capacity of 2 GB.</p>
VGA	<p>The P4IBAD includes a 4xAGP slot that provides four times the bandwidth of the original AGP specification. AGP technology provides a direct connection between the graphics sub-system and the processor so that the graphics do not have to compete for processor time with other devices on the PCI bus.</p>
AC' 97 Audio Codec	<p>The AC' 97 Audio codec is compliant with the AC' 97 2.2 specification, and supports 18-bit ADC (Analog Digital Converter) and DAC (Digital Analog Converter) resolution as well as 18-bit stereo full-duplex codec with independent and variable sampling rates.</p>
Expansion Options	<p>The mainboard comes with the following expansion options:</p> <ul style="list-style-type: none"> • Six 32-bit PCI slots • One 4xAGP slot (support 1.5V only) • One Communications Network Riser (CNR) slot • Four IDE channels and a floppy disk drive interface <p>The P4IBAD supports Ultra DMA bus mastering with transfer rates of 33/66/100 MB/sec.</p>
Integrated I/O	<p>The mainboard has a full set of I/O ports and connectors:</p> <ul style="list-style-type: none"> • Two PS/2 ports for mouse and keyboard

	<ul style="list-style-type: none"> • Two serial ports • One parallel port • One MIDI/game port • Two USB ports • Audio jacks for microphone, line-in and line-out
BIOS Firmware	<p>This mainboard uses Award BIOS that enables users to configure many system features including the following:</p> <ul style="list-style-type: none"> • Power management • Wake-up alarms • CPU parameters and memory timing • CPU and memory timing <p>The firmware can also be used to set parameters for different processor clock speeds.</p>
HPT372 Raid (optional)	<ul style="list-style-type: none"> • HPT372 (Supports two "Ultra DMA 133" IDE channels) • 144-pin LQFP package • 256 Bytes FIFO per ATA channel • Supports RAID function (RAID 0, 1, 0+1) • PIO and bus master access concurrently (ATA port accessible during DMA transfer) • Total IDE bus tri-state by software control and supports hotswap (Low signal Current) • Supports the most popular OS like Windows 95/98, Windows NT 4.0, Windows 2000 and Linux • Supports ATA/ATAPI, PIO Mode 0, 1, 2, 3, 4, DMA Mode 0, 1, 2, Ultra DMA 0, 1, 2, 3, 4, 5

Choosing a Computer Case

There are many types of computer cases on the market. The mainboard complies with the specifications for the ATX system case. Some features on the mainboard are implemented by cabling connectors on the mainboard to indicators and switches on the system case. Ensure that your case supports all the features required. The mainboard can support one or two floppy diskette drives and four enhanced IDE drives. Ensure that your case has sufficient power and space for all the drives that you intend to install.

Most cases have a choice of I/O templates in the rear panel. Make sure that the I/O template in the case matches the I/O ports installed on the rear edge of the mainboard.

This mainboard has an ATX form factor of 304 mm x 244 mm. Choose a case that accommodates this form factor.

Mainboard Components

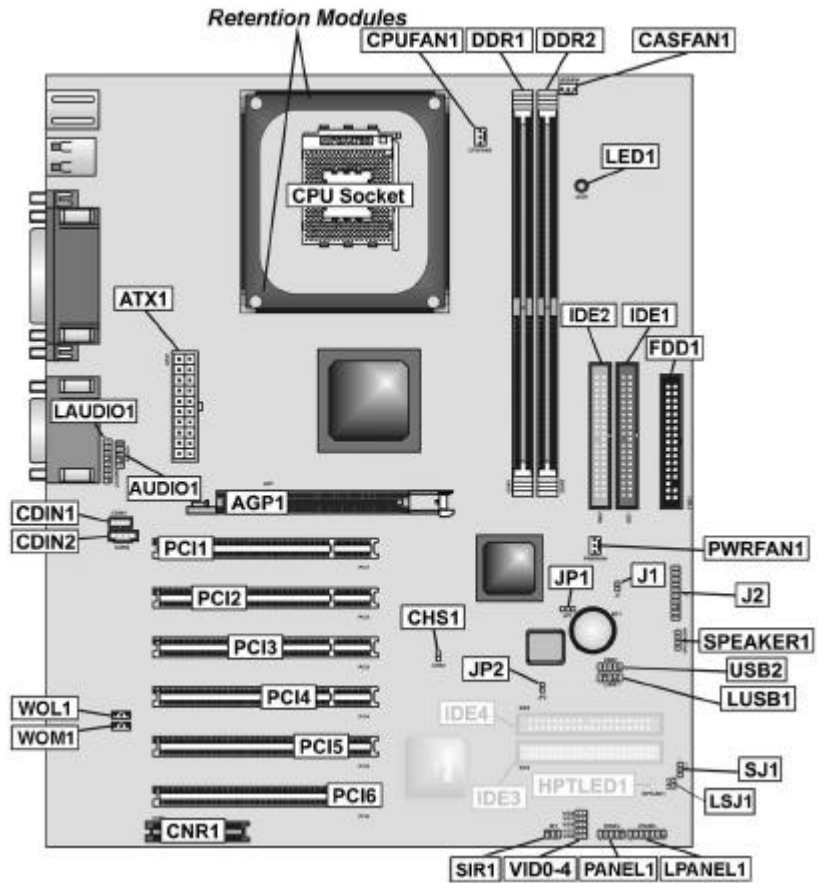

Table of Mainboard Components

Label	Component
AGP1	Accelerated Graphics Port
ATX1	Standard 20-pin ATX power connector
AUDIO	Mic/SpeakerOut header
BAT1	Three volt realtime clock battery
CASFAN1	Case Fan
CDIN1	CD-in connector (Panasonic)
CDIN2	CD-in connector (Sony)
CPUFAN1	Cooling fan for CPU
CNR1	Communications Networking Riser slot
CPU Socket	CPU socket (mPGA478)
DIMM1 ~ DIMM2	Two 184-pin DDR sockets
FDD1	Floppy disk drive connector
IDE 1	Primary IDE channel
IDE 2	Secondary IDE channel
IDE 3 (optional)	Ultra DMA 133 IDE connector
IDE 4 (optional)	Ultra DMA 133 IDE connector
J1	External SMI connector
J2	Smart I/O connector
JP1	Clear CMOS jumper
JP2	BIOS protect jumper
HPTLED1 (optional)	IDE Raid LED
LED1	LED status indicator connector
LAUDIO1	Mic/SpeakerOut connector
LSJ1	Single color LED header (comply with OEM specs. only)
LUSB1	USB connector 2
LPANEL1	Panel connector for case switches and LEDs
PANEL1	Front panel connectors for case switches and LEDs
PCI1 ~ PCI6	Six 32-bit add-on card slots
PWRFAN1	Power fan connector
SIR1	Serial IR port
SPEAKER1	Speaker connector
SJ1	Single color LED header
USB2	Front panel USB headers
VID0-VID4	Core voltage selector jumpers (for manufacturing test only)
WOL1	Wake On LAN wakeup connector
WOM1	Wake On Modem wakeup connector

Note: LED1/HPTLED1 is usually connected to a light that indicates that the computer is powered on. Do not install hardware or disconnect power cables while the LED is on.

This concludes Chapter 1. The next chapter explains how to install the mainboard.

Chapter 2

Installing the Mainboard

Safety Precautions

Follow these safety precautions when installing the mainboard:

- Wear a grounding strap attached to a grounded device to avoid damage from static electricity.
- Discharge static electricity by touching the metal case of a safely grounded object before working on the mainboard.
- Leave components in the static-proof bags they came in.
- Hold all circuit boards by the edges. Do not bend circuit boards.

Quick Guide

This Quick Guide suggests the steps you can take to assemble your system with the mainboards.

The following table provides a reference for installing specific components:

Locating Mainboard Components	Go to page 4
Installing the Mainboard in a Case	Go to page 7
Setting Jumpers	Go to page 7
Installing Case Components	Go to page 9
Installing the CPU	Go to page 10
Installing Memory	Go to page 13
Installing a HDD and CD-ROM Drive	Go to page 14
Installing a FDD	Go to page 15
Installing Add-on Cards	Go to page 16
Connecting Options	Go to page 17
Connecting Peripheral (I/O) Devices	Go to page 21

Installing the Mainboard in a Case

Refer to the following illustration and instructions for installing the mainboard in a case:

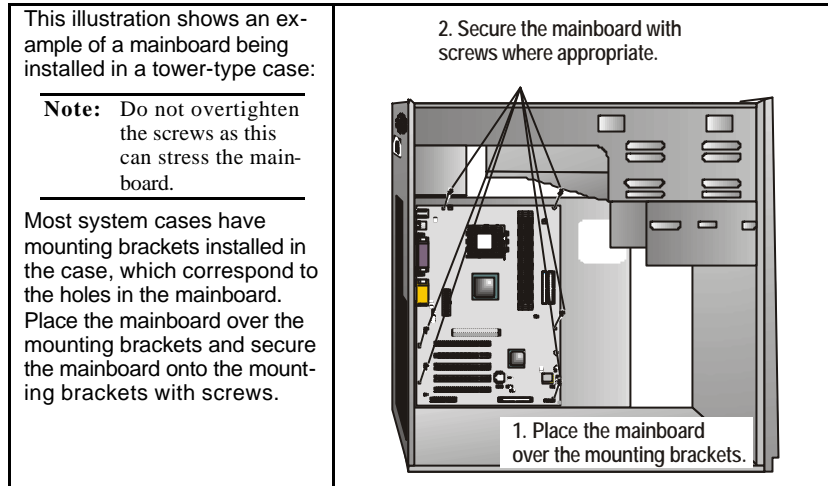

Ensure that your case has an I/O template that supports the I/O ports and expansion slots on your mainboard.

Checking Jumper Settings

This section explains how to set jumpers for correct configuration of the mainboard.

Setting Jumpers

Use the mainboard jumpers to set system configuration options. Jumpers with more than one pin are numbered. When setting the jumpers, ensure that the jumper caps are placed on the correct pins.

The illustrations below show a 2-pin jumper. When the jumper cap is placed on both pins, the jumper is SHORT. If you remove the jumper cap, or place the jumper cap on just one pin, the jumper is OPEN.

This illustration shows a 3-pin jumper. Pins 1 and 2 are SHORT.

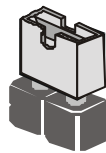

Short

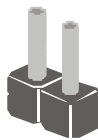

Open

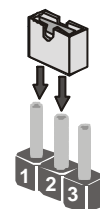

Checking Jumper Settings

The following illustration shows the location of the mainboard jumpers. Pin 1 is labeled.

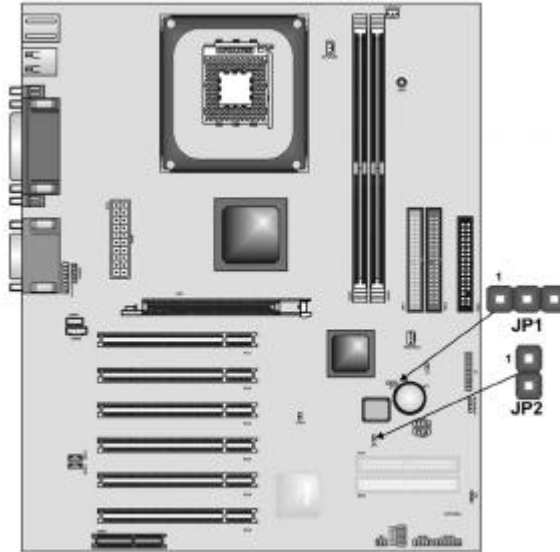

Jumper Settings

Jumper	Type	Description	Setting (default)
JP1	3-pin	Clear CMOS	1-2: Normal 2-3: Clear
JP2	2-pin	BIOS flash protection	Short: Enable Open: Disable

JP1 – This jumper enables you to reset BIOS. Follow these instructions:

1. Turn the system off.
2. Short pins 2 and 3 on JP1.
3. Return the jumper to the normal setting.
4. Turn the system on. The BIOS is returned to the default settings.

JP2 – Enables you to prevent the BIOS from being updated (flashed). Open the jumper if you are going to update your BIOS. After updating the BIOS, short the jumper to protect the BIOS from being flashed. For instructions on updating the BIOS refer to Chapter 3.

Connecting Case Components

After you have installed the mainboard into a case, you can begin connecting the mainboard components. Refer to the following:

1. Connect the case power supply connector to ATX1.
2. Connect the CPU cooling fan cable to CPUFAN1.
3. Connect the case cooling fan connector to CASFAN1
4. Connect the auxiliary power supply cooling fan connector to PWRFAN1.

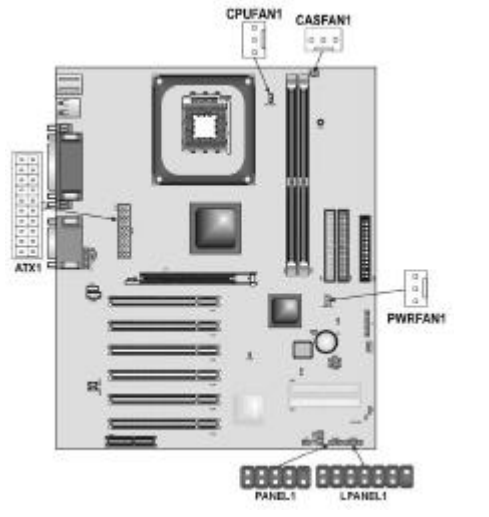

The Panel Connectors

The panel connector (PANEL1 and LPANEL1) provides a standard set of switch and LED connectors commonly found on ATX or micro-ATX cases. The LPANEL1 connector is designed specially for OEM customers, which comply with the OEM specifications. Refer to the table below for information:

PANEL1

Device	Pins
Empty	10
N/C	9
Power ON/OFF	6, 8
Reset Switch	5, 7
Green LED Indicator	2, 4
HDD LED	+1, -3

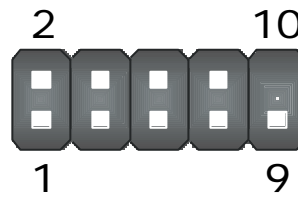

LPANEL1

Device	Pins
Reset Switch	13, 14
Case Speaker	9, 10, 11, 12
Power Switch	5, 6
Power LED	+4
Green Power LED	-3
Yellow Power LED	-2
HDD LED	+1, 8
Empty	7



Note: The plus sign (+) indicates a pin which must be connected to a positive voltage.

Installing Hardware

Installing the Processor

Caution: When installing a CPU heatsink and cooling fan make sure that you **DO NOT** scratch the mainboard or any of the surface-mount resistors with the clip of the cooling fan. If the clip of the cooling fan scrapes across the mainboard, you may cause serious damage to the mainboard or its components.

On most mainboards, there are small surface-mount resistors near the processor socket, which may be damaged if the cooling fan is carelessly installed.

Avoid using cooling fans with sharp edges on the fan casing and the clips. Also, install the cooling fan in a well-lit work area so that you can clearly see the mainboard and processor socket.

Before installing the Processor

This mainboard automatically determines the CPU clock frequency and system bus frequency for the processor. You may be able to change these settings by making changes to jumpers on the mainboard, or changing the settings in the system Setup Utility. We strongly recommend that you do not overclock processors or other components to run faster than their rated speed.

Warning: Overclocking components can adversely affect the reliability of the system and introduce errors into your system. Overclocking can permanently damage the mainboard by generating excess heat in components that are run beyond the rated limits.

This mainboard has a mPGA478 socket. When choosing a processor, consider the performance requirements of the system. Performance is based on the processor design, the clock speed and system bus frequency of the proc-

essor, and the quantity of internal cache memory and external cache memory.

CPU Installation Procedure

The following illustration shows CPU installation components:

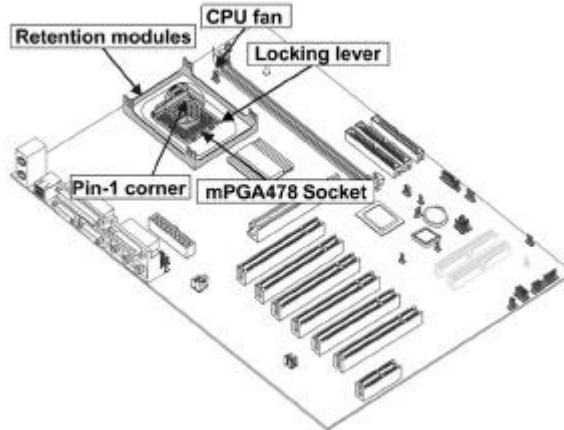

Note: The pin-1 corner is marked with an arrow ▼

Follow these instructions to install the CPU:

1. Install and secure the Retention Module on the mainboard.	
2. Pull the CPU socket locking lever away from the socket to unhook it and raise the locking lever to the upright position.	
3. Match the corner on the CPU marked with an arrow with pin-1 on the CPU socket (the corner with the pinhole noticeably missing). Insert the processor into the socket. Do not use force.	An isometric diagram of the mainboard showing the CPU being inserted into the mPGA478 socket. Labels with arrows point to the 'Locking lever' and the 'Pin-1 corner' on the CPU socket.
4. Lower the heatsink over the CPU.	
5. Lower the CPU cooling fan onto the heatsink.	
6. Apply thermal grease to the top of the CPU.	

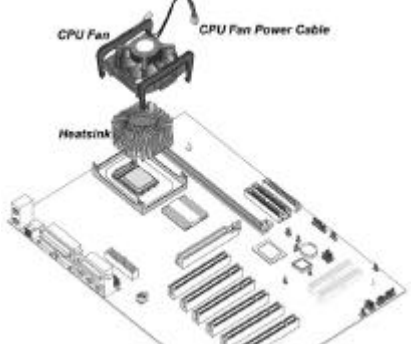
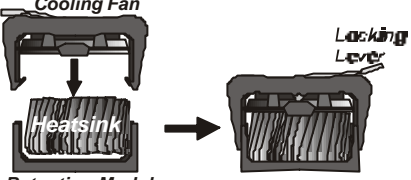
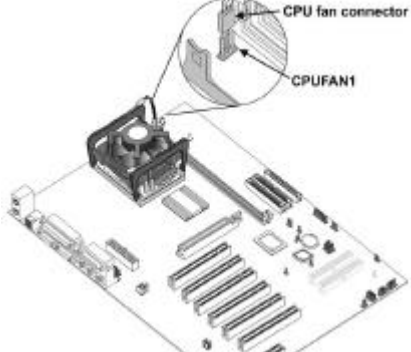
<p>7. Swing the locking lever down and hook it under the latch on the edge of the socket.</p>	
<p>8. Snap the four retention legs of the cooling fan into place (see diagram below).</p>	
<p>9. Swing both lock levers on top of the cooling fan to their opposite sides to secure the cooling fan on top of the heatsink.</p>	
<p>10. Connect the CPU Cooling Fan power cable to the CPUFAN1 connector.</p>	

Note: CPU fan and heatsink installation procedures may vary with the type of CPU fan/heatsink supplied. The form and size of fan/heatsink may also vary.

Installing Memory Modules

This mainboard accommodates 184-pin 2.5V unbuffered Double Data Rate (DDR) SDRAM memory modules. The memory chips must be standard or registered SDRAM (Synchronous Dynamic Random Access Memory).

Installation Procedure

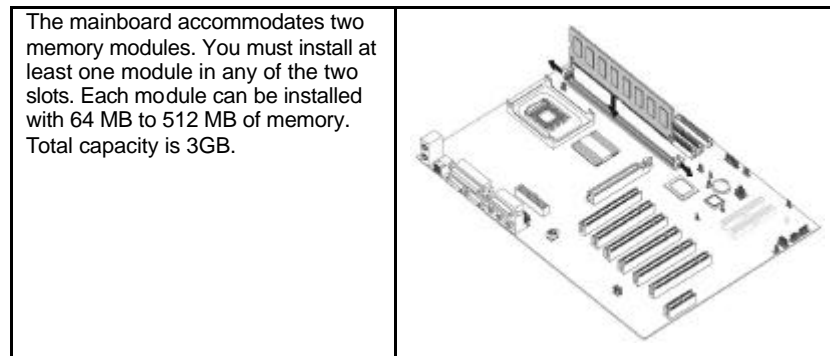

Refer to the following to install the memory modules.

1. Push the latches on each side of the DIMM slot down.
2. Align the memory module with the slot. The DIMM slots are keyed with notches and the DIMMs are keyed with cutouts so that they can only be installed correctly.
3. Check that the cutouts on the DIMM module edge connector match the notches in the DIMM slot:
4. Install the DIMM module into the slot and press it firmly down until it seats correctly. The slot latches are levered upwards and latch on to the edges of the DIMM.
5. Install any remaining DIMM modules.

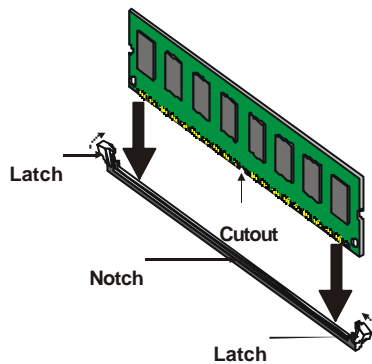

Installing a Hard Disk Drive/CD-ROM

This section describes how to install IDE devices such as a hard disk drive and a CD-ROM drive.

About IDE Devices

Your mainboard has a primary and secondary IDE channel interface (IDE1 and IDE2). An IDE ribbon cable supporting two IDE devices is bundled with the mainboard.

If you want to install more than two IDE devices, get a second IDE cable and you can add two more devices to the secondary IDE channel.

IDE devices have jumpers or switches that are used to set the IDE device as MASTER or SLAVE. Refer to the IDE device user's manual. When installing two IDE devices on one cable, ensure that one device is set to MASTER and the other device is set to SLAVE. The documentation of your IDE device explains how to do this.

This mainboard has an optional HPT372 controller providing PCI-to-IDE UDMA/ATA133 RAID support. It also supplies two optional onboard IDE connectors (IDE3 and IDE4), which can connect to a Master and Slave drive. You can use them to configure the RAID 0 or 1 arrays and connect up to eight hard disk drives, CD-ROM, 120MB Floppy (reserved for future BIOS) and other devices to IDE1, IDE2, IDE3 and IDE4.

About UltraDMA

This mainboard supports UltraDMA 66/100. UDMA is a technology that accelerates the performance of devices in the IDE channel. To maximize performance, install IDE devices that support UDMA and use 80-pin IDE cables that support UDMA 66/100.

Installing a Hard Disk Drive

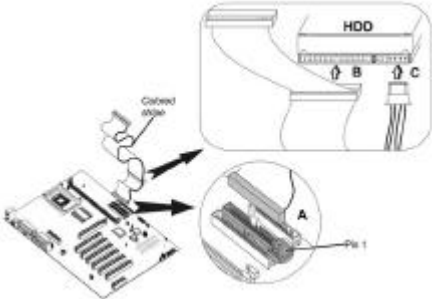
<p>1. Install the hard disk drive into the drive cage in your system case.</p> <p>2. Plug the IDE cable into IDE1 (A):</p> <p>Note: Ribbon cable connectors are usually keyed so that they can only be installed correctly on the device connector. If the connector is not keyed, make sure that you match the pin-1 side of the cable connector with the pin-1 side of the device connector. Each connector has the pin-1 side clearly marked. The pin-1 side of each ribbon cable is always marked with a colored stripe on the cable.</p>	
<p>3. Plug an IDE cable connector into the hard disk drive IDE connector (B). It doesn't matter which connector on the cable you use.</p>	

4. Plug a power cable from the case power supply into the power connector on the hard disk drive (C).

When you first start up your system, the BIOS should automatically detect your hard disk drive. If it doesn't, enter the Setup Utility and use the IDE Hard Disk Auto Detect feature to configure the hard disk drive that you have installed. See IDE HDD Auto-Detection on page 27 for more information.

Installing a CD-ROM/DVD Drive

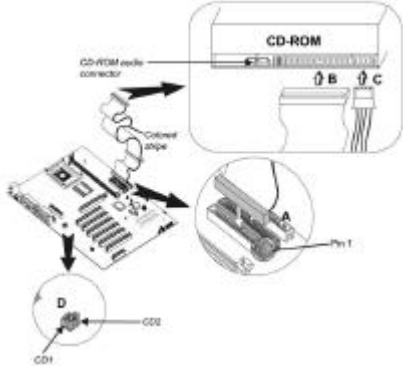
- | | |
|---|---|
| <ol style="list-style-type: none"> 1. Install the CD-ROM/DVD drive into the drive cage in your system case. 2. Plug the IDE cable into IDE1 (A). If you have already installed an HDD, use the other connector on the IDE cable.
Note: Ribbon cable connectors are usually keyed so that they can only be installed correctly on the device connector. If the connector is not keyed, make sure that you match the pin-1 side of the cable connector with the pin-1 side of the device connector. Each connector has the pin-1 side clearly marked. The pin-1 side of each ribbon cable is always marked with a colored stripe on the cable. |  |
| <ol style="list-style-type: none"> 3. Plug an IDE cable connector into the CD-ROM/DVD drive IDE connector (B). It doesn't matter which connector on the cable you use. | |
| <ol style="list-style-type: none"> 4. Plug a power cable from the case power supply into the power connector on the CD-ROM/DVD drive (C). | |
| <ol style="list-style-type: none"> 5. Use the audio cable provided with the CD-ROM/DVD drive to connect to the mainboard CD-in connector CDIN1 or CDIN2 (D). | |

When you first start up your system, the BIOS should automatically detect your CD-ROM/DVD drive. If it doesn't, enter the Setup Utility and configure the CD-ROM/DVD drive that you have installed. See IDE Primary/Secondary Master/Slave (Auto) on page 27 for more information.

Installing a Floppy Diskette Drive

The mainboard has a floppy diskette drive (FDD) interface and ships with a diskette drive ribbon cable that supports one or two floppy diskette drives. You can install a 5.25-inch drive and a 3.5-inch drive with various capacities. The floppy diskette drive cable has one type of connector for a 5.25-inch drive and another type of connector for a 3.5-inch drive.

1. Install the FDD into the drive cage in your system case.

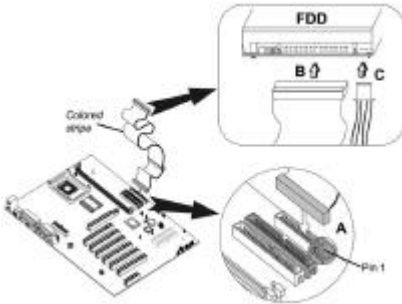
<p>2. Plug the FDD cable into FLOPPY1 (A):</p> <p>Note: Ribbon cable connectors are usually keyed so that they can only be installed correctly on the device connector. If the connector is not keyed, make sure that you match the pin-1 side of the cable connector with the pin-1 side of the device connector. Each connector has the pin-1 side clearly marked. The pin-1 side of each ribbon cable is always marked with a colored stripe on the cable.</p>	
<p>3. Plug the correct connector on the FDD cable for the 5.25-inch or 3.5-inch drive into the FDD connector (B).</p>	
<p>4. Plug a power cable from the case power supply into the power connector on the FDD (C).</p>	

When you first start up your system, go immediately to the Setup Utility to configure the floppy diskette drives that you have installed. See Standard CMOS Features on page 26 for more information.

Installing Add-on Cards

This mainboard has five 32-bit PCI (Peripheral Components Interconnect) expansion slots, one 4xAGP slot, and one Communications and Networking Riser (CNR) slot.

PCI Slots PCI slots are used to install expansion cards that have the 32-bit PCI interface.

4xAGP Slot The 4xAGP slot is used to install a graphics adapter that supports the 4xAGP specification and has a 4xAGP edge connector.

CNR Slot This slot is used to insert CNR cards with Modem and Audio functionality.

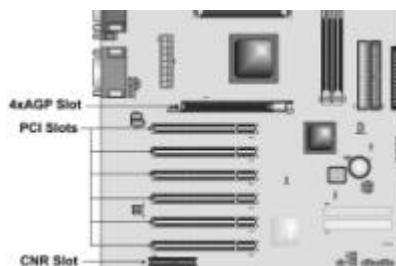

Note: Before installing an add-on card, check the documentation for the card carefully. If the card is not Plug and Play, you may have to manually configure the card before installation.

Follow these instructions to install an add-on card:

1. Remove a blanking plate from the system case corresponding to the slot you are going to use.

2. Install the edge connector of the add-on card into the expansion slot. Ensure that the edge connector is correctly seated in the slot.

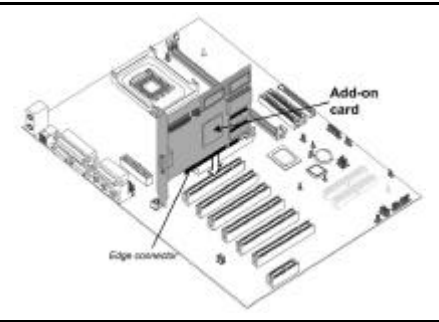

3. Secure the metal bracket of the card to the system case with a screw.

Note: For some add-on cards, for example graphics adapters and network adapters, you have to install drivers and software before you can begin using the add-on card.

Connecting Optional Devices

Refer to the following for information on connecting the mainboard's optional devices:

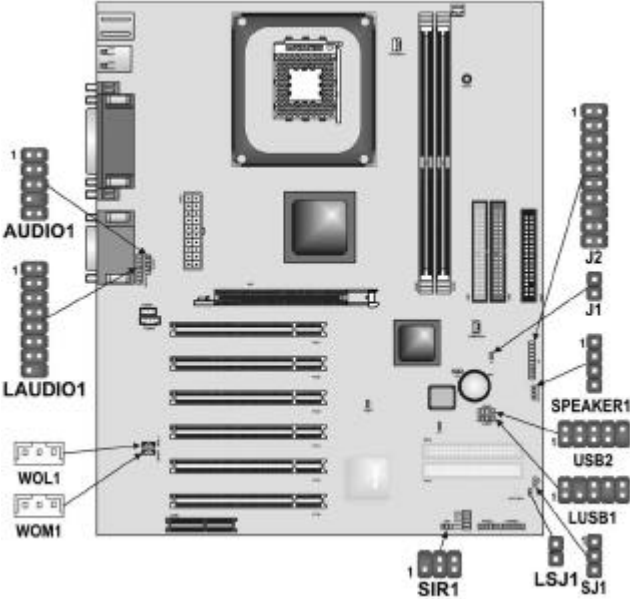

LAUDIO1: Front panel audio header

This header allows the user to install auxiliary front-oriented microphone and line-out ports for easier access.

Pin	Signal Name	Pin	Signal Name
1	ACTIVE LINE-OUT (R)	2	ACTIVE LINE-OUT (L)
3	GND (aLO)	4	GND (aLO)
5	GND (+12)	6	GND (+12)
7	+12V (1A)	8	Empty
9	MIC	10	GND (MIC)
11	FRONT LINE-OUT (R)	12	LINE NEXT (R)
13	FRONT LINE-OUT (L)	14	LINE NEXT (L)
15	GND (fLO)	16	Empty

AUDIO1: Front panel MIC/speaker-out header

This header allows the user to install auxiliary front-oriented microphone and line-out ports for easier access.

Pin	Signal Name	Pin	Signal Name
1	MICIN	2	AGND
3	MICBIAS	4	5V
5	SPKOUTR	6	XSPKOUTR
7	Key	8	Empty
9	SPKOUTL	10	XSPKOUTL

USB2: Onboard USB port

The mainboard has USB ports installed on the rear edge I/O port array. However, some computer cases have a special module that mounts USB ports at the front of the case. If you have this kind of case, use auxiliary USB connector USB2 to connect the front-mounted ports to the mainboard.

Pin	Signal Name	Pin	Signal Name
1	VCC	2	VCC
3	USBP2-N	4	USBP3-N
5	USBP2-P	6	USBP3-P
7	GND	8	GND
9	Key	10	OC#

SPEAKER1: Internal speaker

Connect the internal speaker connector to this header.

Pin	Signal Name
1	External speaker
2	Onboard buzzer
3	NC
4	VCC

LUSB1: USB panel connector 2

This USB panel connector which is specially designed for OEM customers connects to the front panel or case USB ports that comply with the OEM specifications.

Pin	Signal Name	Pin	Signal Name
1	USBPWR	2	Ground
3	USBPP2-	4	Key
5	USBPP2+	6	USBPP3+
7	Key	8	USBPP3-
9	Ground	10	USBPWR2

Note: Please make sure that the USB cable has the same pin assignment as indicated above. A different pin assignment may cause damage or system hang-up

WOL1/WOM1: Wake On LAN/Wake On Modem

If you have installed a LAN card, use the cable provided with the card to plug into the mainboard WOL1 connector. This enables the Wake On LAN (WOL1) feature. When your system is in a power-saving mode, any LAN signal automatically resumes the system. You must enable this item using the Power Management page of the Setup Utility.

Pin	Signal Name
1	5VSB
2	Ground
3	SENSE

If you have installed a modem, use the cable provided with the modem to plug into the mainboard WOM1 connector. This enables the Wake On Modem (WOM) feature. When your system is in a power-saving mode, any modem signal automatically resumes the system. You must enable this item using the Power Management page of the Setup Utility. See Chapter 3 for more information.

J1: System Management Interrupt

This connector is for use with SMI hardware interrupt power management.

Pin	Signal Name
1	ExtSMI
2	Ground

J2: Smart I/O

The Smart I/O connector is for use with media storage devices using the LPC interface.

Pin	Signal Name	Pin	Signal Name
1	PCICLK	11	VCC3
2	SERIRQ	12	VCC3
3	LFRAME#	13	GND
4	LDRQ#	14	GND
5	LAD0	15	5VSB
6	LAD1	16	GND
7	LAD2	17	GND
8	LAD3	18	RESERVED(GND)
9	PCIRST#	19	VCC5
10	PME#	20	VCC5

SIR1: Serial infrared port

The mainboard supports a Serial Infrared (SIR) data port. Infrared ports allow the wireless exchange of information between your computer and similarly equipped devices such as printers, laptops, Personal Digital Assistants (PDAs), and other computers.

Pin	Signal Name	Pin	Signal Name
1	RESERVED	2	EMPTY
3	VCC	4	GROUND
5	IRTX	6	IRRX

SJ1: Single color LED header

This header allows the user to install a LED indicator to indicate when the computer is in Suspend to RAM (STR) mode or normal mode.

Pin	Signal Name
1	SUSLED-G
2	SUSLED-G
3	5VSB

ACPI LED function:

 SJ1	S0	S1	S3	S4/S5
		Light	Blinking	Blinking

LSJ1: Single color LED header

This header which is specially designed for OEM customers allows the user to install a LED indicator to indicate when the computer is in Suspend to RAM (STR) mode or normal mode.

Pin	Signal Name
1	5 VSB
2	SUSLED-Y

ACPI LED function:

LSJ1	S0	S1	S3	S4/S5
	Dark	Dark	Light	Dark

Connecting I/O Devices

The backplane of the mainboard has the following I/O ports:

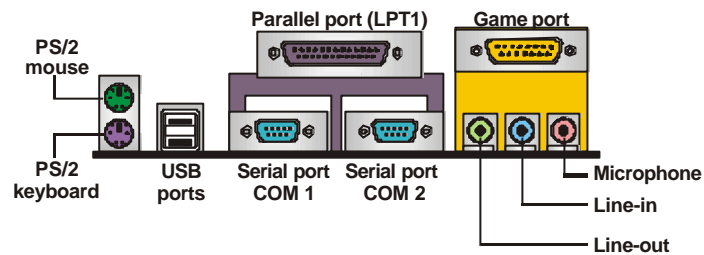

PS/2 Mouse Use the upper PS/2 port to connect a PS/2 pointing device.

PS/2 Keyboard Use the lower PS/2 port to connect a PS/2 keyboard.

USB Ports Use the USB ports to connect USB devices.

LPT1 Use LPT1 to connect printers or other parallel communications devices.

COM1/2 Use the COM ports to connect serial devices such as mice or fax/modems. COM1 is identified by the system as COM1/3. COM2 is identified by the system as COM2/4.

Game Port Use the game port to connect a joystick or a MIDI device.

Audio Ports Use the three audio ports to connect audio devices. The left side jack is for a stereo line-out signal. The middle jack is for a stereo line-in signal. The right side jack is for a microphone.

PS/2 Mouse Use the upper PS/2 port to connect a PS/2 pointing device.

External Connector Color Coding

Many connectors now use standard colors as shown in the table below.

Connector	Color
Audio line-in	Light blue
Audio line-out	Lime
Digital monitor/flat panel	White
IEEE 1394	Grey
Microphone	Pink
MIDI/game	Gold
Parallel	Burgundy
PS/2-compatible keyboard	Purple
PS/2-compatible mouse	Green
Serial	Teal or Turquoise
Speaker out/subwoofer	Orange
Right-to-left speaker	Brown
USB	Black
SCSI, network, telephone, modem	None

This concludes Chapter 2. The next chapter covers the BIOS.

Chapter 3

Using BIOS

About the Setup Utility

The computer uses the latest Award BIOS with support for Windows Plug and Play. The CMOS chip on the mainboard contains the ROM setup instructions for configuring the mainboard BIOS.

The BIOS (Basic Input and Output System) Setup Utility displays the system's configuration status and provides you with options to set system parameters. The parameters are stored in battery-backed-up CMOS RAM that saves this information when the power is turned off. When the system is turned back on, the system is configured with the values you stored in CMOS.

The BIOS Setup Utility enables you to configure:

- Hard drives, diskette drives, and peripherals
- Video display type and display options
- Password protection from unauthorized use
- Power management features

The settings made in the Setup Utility affect how the computer performs. Before using the Setup Utility, ensure that you understand the Setup Utility options.

This chapter provides explanations for Setup Utility options.

The Standard Configuration

A standard configuration has already been set in the Setup Utility. However, we recommend that you read this chapter in case you need to make any changes in the future.

This Setup Utility should be used:

- when changing the system configuration
- when a configuration error is detected and you are prompted to make changes to the Setup Utility
- when trying to resolve IRQ conflicts
- when making changes to the Power Management configuration
- when changing the password or making other changes to the Security Setup

Entering the Setup Utility

When you power on the system, BIOS enters the Power-On Self Test (POST) routines. POST is a series of built-in diagnostics performed by the BIOS. After the POST routines are completed, the following message appears:

Press DEL to enter SETUP

Pressing the delete key  accesses the BIOS Setup Utility:

CMOS Setup Utility – Copyright (C) 1984 – 2001 Award Software

▶ Standard CMOS Features	▶ Frequency/Voltage Control
▶ Advanced BIOS Features	Load Fail-Safe Defaults
▶ Advanced Chipset Features	Load Optimized Defaults
▶ Integrated Peripherals	Set Password
▶ Power Management Setup	Save & Exit Setup
▶ PnP/PCI Configurations	Exit Without Saving
▶ PC Health Status	
Esc : Quit	- - ® - - : Select Item
F10 : Save & Exit Setup	
Time, Date, Hard Disk Type . . .	

BIOS Navigation Keys

The BIOS navigation keys are listed below:

Key	Function
Esc	Exits the current menu
←↑↓→	Scrolls through the items on a menu
+/-/PU/PD	Modifies the selected field's values
F10	Saves the current configuration and exits setup
F1	Displays a screen that describes all key functions
F5	Loads previously saved values to CMOS
F6	Loads a minimum configuration for troubleshooting.
F7	Loads an optimum set of values for peak performance

Updating the BIOS

You can download and install updated BIOS for this mainboard from the manufacturer's Web site. New BIOS provides support for new peripherals, improvements in performance, or fixes for known bugs. Install new BIOS as follows:

1. If your mainboard has a BIOS protection jumper, change the setting to allow BIOS flashing.

2. If your mainboard has an item called Firmware Write Protect in Advanced BIOS features, disable it. (Firmware Write Protect prevents BIOS from being overwritten.)
3. Create a bootable system disk. (Refer to Windows online help for information on creating a bootable system disk.)
4. Download the Flash Utility and new BIOS file from the manufacturer's Web site. Copy these files to the system diskette you created in Step 3.
5. Turn off your computer and insert the system diskette in your computer's diskette drive. (You might need to run the Setup Utility and change the boot priority items on the Advanced BIOS Features Setup page, to force your computer to boot from the floppy diskette drive first.)
6. At the A:\ prompt, type the Flash Utility program name and press <Enter>. You see a screen similar to the following:

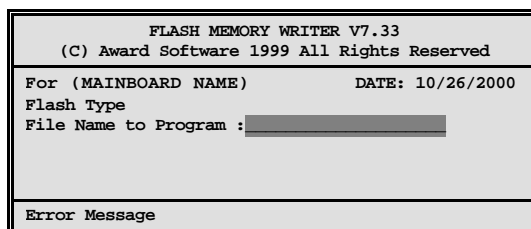

7. Type the filename of the new BIOS in the "File Name to Program" text box. Follow the onscreen directions to update the mainboard BIOS.
8. When the installation is complete, remove the floppy diskette from the diskette drive and restart your computer. If your mainboard has a Flash BIOS jumper, reset the jumper to protect the newly installed BIOS from being overwritten.

Using BIOS

When you start the Setup Utility, the main menu appears. The main menu of the Setup Utility displays a list of the options that are available. A highlight indicates which option is currently selected. Use the cursor arrow keys to move the highlight to other options. When an option is highlighted, execute the option by pressing <Enter>.

Some options lead to pop-up dialog boxes that prompt you to verify that you wish to execute that option. Other options lead to dialog boxes that prompt you for information.

Some options (marked with a triangle ►) lead to submenus that enable you to change the values for the option. Use the cursor arrow keys to scroll through the items in the submenu.

In this manual, default values are enclosed in parenthesis. Submenu items are denoted by a triangle ►.

Standard CMOS Features

This option displays basic information about your system.

CMOS Setup Utility – Copyright (C) 1984 – 2001 Award Software
Standard CMOS Features

Date (mm:dd:yy)	Tue, July 11 2001	Item Help
Time (hh:mm:ss)	12 : 8 : 59	
▶ IDE Primary Master		Menu Level ▶
▶ IDE Primary Slave		Change the day, month, year and century.
▶ IDE Secondary Master		
▶ IDE Secondary Slave		
Drive A	[1.44M, 3.5 in.]	
Drive B	[None]	
Floppy 3 Mode Support	[Disabled]	
Video	[EGA/VGA]	
Halt On	[All Errors]	
Base Memory	640K	
Extended Memory	31744K	
Total Memory	32768K	

- ~ ® ~ : Move Enter : Select +/-/PU/PD:Value: F10: Save ESC: Exit F1:General Help
F5:Previous Values F6:Fail-Safe Defaults F7:Optimized Defaults

Date and Time

The Date and Time items show the current date and time on the computer. If you are running a Windows OS, these items are automatically updated whenever you make changes to the Windows Date and Time Properties utility.

▶ IDE Devices (None)

Your computer has two IDE channels (Primary and Secondary) and each channel can be installed with one or two devices (Master and Slave). Use these items to configure each device on the IDE channel.

Press <Enter> to display the IDE submenu:

CMOS Setup Utility – Copyright © 1984 – 2001 Award Software
IDE Primary Master

IDE HDD Auto-Detection	[Press Enter]	Item Help
IDE Primary Master Access Mode	[Auto] [Auto]	
Capacity	0 MB	Menu Level ▶▶
Cylinder	0	To auto-detect the HDD' s size, head . . . on this channel
Head	0	
Precomp	0	
Landing Zone	0	
Sector	0	

- ~ ® ~ : Move Enter : Select +/-/PU/PD:Value: F10: Save ESC: Exit F1:General Help
F5:Previous Values F6:Fail-Safe Defaults F7:Optimized Defaults

IDE HDD Auto-Detection

Press <Enter> while this item is highlighted to prompt the Setup Utility to automatically detect and configure an IDE device on the IDE channel.

Note: If you are setting up a new hard disk drive that supports LBA mode, more than one line will appear in the parameter box. Choose the line that lists LBA for an LBA drive.

IDE Primary/Secondary Master/Slave (Auto)

Leave this item at Auto to enable the system to automatically detect and configure IDE devices on the channel. If it fails to find a device, change the value to Manual and then manually configure the drive by entering the characteristics of the drive in the items described below.

Refer to your drive's documentation or look on the drive casing if you need to obtain this information. If no device is installed, change the value to None.

Note: Before attempting to configure a hard disk drive, ensure that you have the configuration information supplied by the manufacturer of your hard drive. Incorrect settings can result in your system not recognizing the installed hard disk.

Access Mode

This item defines ways that can be used to access IDE hard disks such as LBA (Large Block Addressing). Leave this value at Auto and the system will automatically decide the fastest way to access the hard disk drive.

Press <Esc> to return to the Standard CMOS Features page.

Drive A/Drive B (1.44M, 3.5 in./None)

These items define the characteristics of any diskette drive attached to the system. You can connect one or two diskette drives.

Floppy 3 Mode Support (Disabled)

Floppy 3 mode refers to a 3.5-inch diskette with a capacity of 1.2 MB. Floppy 3 mode is sometimes used in Japan.

Video (EGA/VGA)

This item defines the video mode of the system. This mainboard has a built-in VGA graphics system; you must leave this item at the default value.

Halt On (All Errors)

This item defines the operation of the system POST (Power On Self Test) routine. You can use this item to select which types of errors in the POST are sufficient to halt the system.

Base Memory, Extended Memory, and Total Memory

These items are automatically detected by the system at start up time. These are display-only fields. You cannot make changes to these fields.

Advanced BIOS Setup Option

This option defines advanced information about your system.

CMOS Setup Utility – Copyright (C) 1984 – 2001 Award Software
Advanced BIOS Features

CPU L1 & L2 Cache	[Enabled]		Item Help
Quick Power On Self Test	[Enabled]		Menu Level ▶
First Boot Device	[Floppy]		Allows you to choose the VIRUS warning feature for IDE Hard
Second Boot Device	[HDD-0]		Disk boot sector protection. If this function is enabled and someone attempts to write data into this area, BIOS will show a warning message on screen and alarm beep
Third Boot Device	[CD-ROM]		
Boot Other Device	[Enabled]		
Swap Floppy Drive	[Disabled]		
Boot Up Floppy Seek	[Enabled]		
Boot Up NumLock Status	[On]		
Gate A20 Option	[Fast]		
Typematic Rate Setting	[Disabled]		
x Typematic Rate (Chars/Sec)	6		
x Typematic Delay (Msec)	250		
Security Option	[Setup]		
APIC Mode	[Enable]		
OS Select For DRAM > 64MB	[Non-OS2]		
HDD S.M.A.R.T Capability	[Disabled]		

- - ® - : Move Enter : Select +/-/PU/PD:Value: F10: Save ESC: Exit F1:General Help
 F5:Previous Values F6:Fail-Safe Defaults F7:Optimized Defaults

CPU L1 & L2 Cache (Enabled)

All processors that can be installed in this mainboard use internal level 1 (L1) and external level 2 (L2) cache memory to improve performance. Leave this item at the default value for better performance.

Quick Power On Self Test (Enabled)

Enable this item to shorten the power on testing (POST) and have your system start up faster. You might like to enable this item after you are confident that your system hardware is operating smoothly.

First/Second/Third Boot Device (Floppy/HDD-0/CD-ROM)

Use these three items to select the priority and order of the devices that your system searches for an operating system at start-up time.

Boot Other Device (Enabled)

When enabled, the system searches all other possible locations for an operating system if it fails to find one in the devices specified under the First, Second, and Third boot devices.

Swap Floppy Drive (Disabled)

If you have two floppy diskette drives in your system, this item allows you to swap the assigned drive letters so that drive A becomes drive B, and drive B becomes drive A.

Boot Up Floppy Seek (Enabled)

If this item is enabled, it checks the size of the floppy disk drives at start-up time. You don't need to enable this item unless you have a legacy diskette drive with 360K capacity.

Boot Up NumLock Status (On)

This item defines if the keyboard Num Lock key is active when your system is started.

Gate A20 Option (Fast)

This item defines how the system handles legacy software that was written for an earlier generation of processors. Leave this item at the default value.

Typematic Rate Setting (Disabled)

If this item is enabled, you can use the following two items to set the typematic rate and the typematic delay settings for your keyboard.

- **Typematic Rate (Chars/Sec):** Use this item to define how many characters per second are generated by a held-down key.
- **Typematic Delay (Msec):** Use this item to define how many milliseconds must elapse before a held-down key begins generating repeat characters.

Security Option (Setup)

If you have installed password protection, this item defines if the password is required at system start up, or if it is only required when a user tries to enter the Setup Utility.

APIC Mode (Enable)

This option enables/disables APIC (Advanced Programmable Interrupt Controller) functionality. The APIC is an Intel chip that provides symmetric multiprocessing (SMP) for its Pentium systems.

OS Select For DRAM > 64 MB (Non-OS2)

This item is only required if you have installed more than 64 MB of memory and you are running the OS/2 operating system. Otherwise, leave this item at the default.

HDD S.M.A.R.T Capability (Disabled)

The S.M.A.R.T. (Self-Monitoring, Analysis, and Reporting Technology) system is a diagnostics technology that monitors and predicts device performance. S.M.A.R.T. software resides on both the disk drive and the host computer.

Report No FDD For WIN 95 (Yes)

Set this item to the default if you are running a system with no floppy drive and using Windows 95; this ensures compatibility with the Windows 95 logo certification.

Small Logo (EPA) Show (Disabled)

Enables or disables the display of the EPA logo during boot.

Firmware Write Protect (Disabled)

Enables or disables the BIOS from being overwritten.

Advanced Chipset Features Option

These items define critical timing parameters of the mainboard. You should leave the items on this page at their default values unless you are very familiar with the technical specifications of your system hardware. If you change the values incorrectly, you may introduce fatal errors or recurring instability into your system.

CMOS Setup Utility – Copyright (C) 1984 – 2001 Award Software
Advanced Chipset Features

DRAM Timing Selectable	[Manual]	Item Help
CAS Latency Time	[2.5]	
Active to Precharge Delay	[7]	Menu Level ▶
DRAM RAS# to CAS# Delay	[3]	
DRAM RAS# Precharge	[3]	
DRAM Data Integrity Mode	[Non-ECC]	
Memory Frequency For	[Auto]	
System BIOS Cacheable	[Disabled]	
Video RAM Cacheable	[Disabled]	
Memory Hole At 15M-16M	[Disabled]	
Delayed Transaction	[Enabled]	
AGP Aperture Size (MB)	[64]	
Delay Prior to Thermal	[16 Min]	

- : Move ® : Select +/-/PU/PD:Value: F10: Save ESC: Exit F1:General Help
F5:Previous Values F6:Fail-Safe Defaults F7:Optimized Defaults

DRAM Timing Selectable (Manual)

The value in this field depends on performance parameters of the installed memory chips (DRAM). Do not change the value from the factory setting unless you install new memory that has a different performance rating than the original DRAMs.

CAS Latency Time: (2.5)

When synchronous DRAM is installed, the number of clock cycles of CAS latency depends on the DRAM timing. Do not reset this field from the default value specified by the system designer.

Active to Precharge Delay (7)

The precharge time is the number of cycles it takes for DRAM to accumulate its charge before refresh.

DRAM RAS# to CAS# Delay (3)

This field lets you insert a timing delay between the CAS and RAS strobe signals, used when DRAM is written to, read from, or refreshed. Disabled gives faster performance; and Enabled gives more stable performance.

DRAM RAS# Precharge (3)

Select the number of CPU clocks allocated for the Row Address Strobe (RAS#) signal to accumulate its charge before the DRAM is refreshed. If insufficient time is allowed, refresh may be incomplete and data lost.

DRAM Data Integrity Mode (Non-ECC)

Select Parity or ECC (error-correcting code), according to the type of installed DRAM.

Memory Frequency For (Auto)

This item sets the main memory frequency. When you use an external graphics card, you can adjust this to enable the best performance for your system.

System BIOS Cacheable (Disabled)

This item allows the system to be cached in memory for faster execution. Enable this item for better performance.

Video RAM Cacheable (Disabled)

These items allow the video BIOS and RAM to be cached in memory for faster execution. Enable these items for better performance.

Memory Hole At 15M-16M (Disabled)

You can reserve this area of system memory for ISA adapter ROM. When this area is reserved, it cannot be cached. The user information of peripherals that need to use this area of system memory usually discusses their memory requirements.

Delayed Transaction (Enabled)

The chipset has an embedded 32-bit posted write buffer to support delayed transaction cycles. Enable this item to support compliance with PCI specification version 2.1.

AGP Aperture Size (64 MB)

This item defines the size of the aperture if you use an AGP graphics adapter. The AGP aperture refers to a section of the PCI memory address range used for graphics memory. We recommend that you leave this item at the default value.

Delay Prior to Thermal (16 Min)

Enables you to set the delay time before the CPU enters auto thermal mode.

Integrated Peripherals Option

These options display items that define the operation of peripheral components on the system's input/output ports.

CMOS Setup Utility – Copyright (C) 1984 – 2001 Award Software
Integrated Peripherals

			Item Help
On-Chip Primary	PCI IDE	[Enabled]	Menu Level ►
IDE Primary Master	PIO	[Auto]	
IDE Primary Slave	PIO	[Auto]	
IDE Primary Master	UDMA	[Auto]	
IDE Primary Slave	UDMA	[Auto]	
On-Chip Secondary	PCI IDE	[Enabled]	
IDE Secondary Master	PIO	[Auto]	
IDE Secondary Slave	PIO	[Auto]	
IDE Secondary Master	UDMA	[Auto]	
IDE Secondary Slave	UDMA	[Auto]	
USB Controller		[Enabled]	
USB Keyboard Support		[Disabled]	
USB Mouse Support		[Disabled]	
AC97 Audio		[Auto]	
AC97 Modem		[Auto]	
Init Display First		[PCI Slot]	
IDE HDD Block Mode		[Enabled]	
POWER ON Function		[Hot KEY]	

- : Move ® : Select +/-/PU/PD: Value: F10: Save ESC: Exit F1: General Help
F5: Previous Values F6: Fail-Safe Defaults F7: Optimized Defaults

On-Chip Primary/Secondary PCI IDE (Enabled)

Use these items to enable or disable the PCI IDE channels that are integrated on the mainboard.

IDE Primary/Secondary Master/Slave PIO (Auto)

Each IDE channel supports a master device and a slave device. These four items let you assign which kind of PIO (Programmed Input/Output) is used by IDE devices. Choose Auto to let the system auto detect which PIO mode is best, or select a PIO mode from 0-4.

IDE Primary/Secondary Master/Slave UDMA (Auto)

Each IDE channel supports a master device and a slave device. This mainboard supports UltraDMA technology, which provides faster access to IDE devices.

If you install a device that supports UltraDMA, change the appropriate item on this list to Auto. You may have to install the UltraDMA driver supplied with this mainboard in order to use an UltraDMA device.

USB Controller (Enabled)

Enable this item if you plan to use the Universal Serial Bus ports on this mainboard.

USB Keyboard Support (Disabled)

Enable this item if you plan to use a keyboard connected through the USB port in a legacy operating system (such as DOS) that does not support Plug

and Play.

USB Mouse Support (Disabled)

Enable this item if you plan to use a USB mouse.

AC97 Audio (Auto)

Enables and disables the onboard audio chip. Disable this item if you are going to install a PCI audio add-on card.

AC97 Modem (Auto)

Enables and disables the onboard modem. Disable this item if you are going to install an external modem.

Init Display First (PCI Slot)

Use this item to specify whether your graphics adapter is installed in one of the PCI slots or is integrated on the mainboard.

IDE HDD Block Mode (Enabled)

Enable this field if your IDE hard drive supports block mode. Block mode enables BIOS to automatically detect the optimal number of block read and writes per sector that the drive can support and improves the speed of access to IDE devices.

POWER ON Function (Hot KEY)

Enables you to set power on parameters. The default setting enables you to use a hot key to turn on the system.

KB Power ON Password (Enter)

When the POWER ON Function is set to Password, use this item to set the password.

Hot Key Power ON (Ctrl-F12)

When the POWER ON Function is set to Hot KEY, use this item to set the hot key combination that turns on the system.

Onboard FDC Controller (Enabled)

This option enables the onboard floppy disk drive controller.

Onboard Serial Port 1 (3F8/IRQ4)

This option is used to assign the I/O address and interrupt request (IRQ) for the onboard serial port 1 (COM1).

Onboard Serial Port 2 (2F8/IRQ3)

This option is used to assign the I/O address and interrupt request (IRQ) for the onboard serial port 2 (COM2).

UART Mode Select (Normal)

This field is available if the Onboard Serial Port 2 field is set to any option but Disabled. UART Mode Select enables you to select the infrared communication protocol-Normal (default), IrDA, or ASKIR. IrDA is an infrared communication protocol with a maximum baud rate up to 115.2K bps. ASKIR is Sharp's infrared communication protocol with a maximum baud rate up to

57.6K bps.

UR2 Duplex Mode (Half)

This field is available when UART 2 Mode is set to either ASKIR or IrDA. This item enables you to determine the infrared function of the onboard infrared chip. The options are Full and Half (default).

Full-duplex means that you can transmit and send information simultaneously. Half-duplex is the transmission of data in both directions, but only one direction at a time.

Onboard Parallel Port (378/IRQ7)

This option is used to assign the I/O address and interrupt request (IRQ) for the onboard parallel port.

Parallel Port Mode (ECP)

Enables you to set the data transfer protocol for your parallel port. There are four options: SPP (Standard Parallel Port), EPP (Enhanced Parallel Port), ECP (Extended Capabilities Port), and ECP+EPP.

SPP allows data output only. Extended Capabilities Port (ECP) and Enhanced Parallel Port (EPP) are bi-directional modes, allowing both data input and output. ECP and EPP modes are only supported with EPP- and ECP-aware peripherals.

ECP Mode Use DMA (3)

When the onboard parallel port is set to ECP mode, the parallel port can use DMA 3 or DMA 1.

Game Port Address (201)

This item sets the I/O address for the game port.

Midi Port Address (330)

This item sets the I/O address for the Midi function.

Midi Port IRQ (10)

This item sets the interrupt request for the Midi function.

SC Port Address (Disabled)

The smart card reader needs a 16-byte fixed I/O address to access data. You may need an optional module to be able to use this function. When this item is set, the following item becomes available:

- **SC Port IRQ:** Enables you to set the smart card IRQ.

MS/SD Port Address (Disabled)

The memory stick/secure digital device needs a 16-byte fixed I/O address to access data. You may need an optional module to use this function. . When this item is set, the following item becomes available:

- **MS/SD Port IRQ:** Enables you to set the Memory stick/secure digital device IRQ.

Power Management Setup Option

This option lets you control system power management. The system has various power-saving modes including powering down the hard disk, turning off the video, suspending to RAM, and software power down that allows the system to be automatically resumed by certain events.

The power-saving modes can be controlled by timeouts. If the system is inactive for a time, the timeouts begin counting. If the inactivity continues so that the timeout period elapses, the system enters a power-saving mode. If any item in the list of Reload Global Timer Events is Enabled, then any activity on that item will reset the timeout counters to zero.

If the system is suspended or has been powered down by software, it can be resumed by a wake up call that is generated by incoming traffic to a modem, a LAN card, a PCI card, or a fixed alarm on the system realtime clock.

CMOS Setup Utility – Copyright (C) 1984 – 2001 Award Software
Power Management Setup

ACPI Function	[Enabled]		Item Help
ACPI Suspend Type	[S1(POS)]		Menu Level ▶
Power Management	[User Define]		
Video Off Method	[DPMS]		
Video Off In Suspend	[Yes]		
Suspend Type	[Stop Grant]		
MODEM Use IRQ	[3]		
Suspend Mode	Disable		
HDD Power Down	Disable		
Soft-Off by PWR-BTTN	[Instant-Off]		
Wake-Up by PCI card	[Enabled]		
Power On by Ring	[Disabled]		
Wake Up On LAN	[Disabled]		
x USB KB Wake-Up From S3	Disabled		
Resume by Alarm	[Disabled]		
x Date (of Month) Alarm	0		
x Time (hh:mm:ss) Alarm	0 0 0		
** Reload Global Timer Events **			

- ↑ ® → : Move Enter : Select +/-/PU/PD:Value: F10: Save ESC: Exit F1:General Help
 F5:Previous Values F6:Fail-Safe Defaults F7:Optimized Defaults

ACPI Function (Enabled)

This mainboard supports ACPI (Advanced Configuration and Power management Interface). Use this item to enable or disable the ACPI feature.

Note: ACPI is a power management specification that makes hardware status information available to the operating system. ACPI enables a PC to turn its peripherals on and off for improved power management. It also allows the PC to be turned on and off by external devices, so that mouse or keyboard activity wakes up the computer.

ACPI Suspend Type (S1(POS))

Use this item to define how your system suspends. In the default, S1(POS), the suspend mode is equivalent to a software power down. If you select S3

(STR), the suspend mode is a suspend to RAM, i.e., the system shuts down with the exception of a refresh current to the system memory.

Power Management (User Define)

This item acts like a master switch for the power-saving modes and hard disk timeouts. If this item is set to Max Saving, power-saving modes occur after a short timeout. If this item is set to Min Saving, power-saving modes occur after a longer timeout. If the item is set to User Define, you can insert your own timeouts for the power-saving modes.

Video Off Method (DPMS)

This item defines how the video is powered down to save power. This item is set to DPMS (Display Power Management Software) by default.

Video Off In Suspend (Yes)

This option defines if the video is powered down when the system is put into suspend mode.

Suspend Type (Stop Grant)

If this item is set to the default Stop Grant, the CPU will go into Idle Mode during power saving mode.

MODEM Use IRQ (3)

If you want an incoming call on a modem to automatically resume the system from a power-saving mode, use this item to specify the interrupt request line (IRQ) that is used by the modem. You might have to connect the fax/modem to the mainboard Wake On Modem connector for this feature to work.

Suspend Mode (Disable)

The CPU clock will be stopped and the video signal will be suspended if no Power Management events occur for a specified length of time. Full power function will return when a Power Management event is detected. Options are from 1 Min to 1 Hour and Disable.

HDD Power Down (Disable)

The IDE hard drive will spin down if it is not accessed within a specified length of time. Options are from 1 Min to 15 Min and Disable.

Soft-Off by PWR-BTTN (Instant-Off)

Under ACPI (Advanced Configuration and Power management Interface) you can create a software power down. In a software power down, the system can be resumed by Wake Up Alarms. This item lets you install a software power down that is controlled by the power button on your system. If the item is set to Instant-Off, then the power button causes a software power down. If the item is set to Delay 4 Sec. then you have to hold the power button down for four seconds to cause a software power down.

Wake-Up by PCI Card (Enabled)

When this item is enabled, the system power will be turned on if there is any PCI card activity.

Power On by Ring (Disabled)

If this item is enabled, it allows the system to resume from a software power down or a power-saving mode whenever there is an incoming call to an installed fax/modem. You have to connect the fax/modem to the mainboard.

Wake Up On LAN (Disabled)

When set to Enabled, the system power will be turned on if the LAN port receives an incoming signal. You have to connect the fax/modem to the mainboard Wake On LAN connector for this feature to work.

USB KB Wake-Up S3 (Disabled)

If you are using a USB keyboard, and the ACPI suspend type is set to S3, you can enable this item to allow a keystroke to wake up the system from power saving mode.

Resume by Alarm (Disabled)

When set to Enabled, additional fields become available and you can set the date (day of the month), hour, minute and second to turn on your system. When set to 0 (zero) for the day of the month, the alarm will power on your system every day at the specified time.

**** Reload Global Timer Events ****

Global Timer (power management) events are I/O events whose occurrence can prevent the system from entering a power saving mode or can awaken the system from such a mode. In effect, the system remains alert for anything that occurs to a device that is configured as Enabled, even when the system is in a power-down mode.

Primary/Secondary IDE 1/0 (Disabled)

When these items are enabled, the system will restart the power-saving timeout counters when any activity is detected on any of the drives or devices on the primary or secondary IDE channels.

FDD, COM, LPT Port (Disabled)

When this item is enabled, the system will restart the power-saving timeout counters when any activity is detected on the floppy disk drive, serial ports, or the parallel port.

PCI PIRQ[A-D]# (Disabled)

When disabled, any PCI device set as the Master will not power on the system.

PWRON After PWR-Fail (Off)

This item enables your computer to automatically restart or return to its last operating status after power returns from a power failure.

PNP/PCI Configuration Option

These options configure how PnP (Plug and Play) and PCI expansion cards oper-

ate in your system. Both the ISA and PCI buses on the Mainboard use system IRQs (Interrupt ReQuests) and DMAs (Direct Memory Access). You must set up the IRQ and DMA assignments correctly through the PnP/PCI Configurations Setup utility for the mainboard to work properly. Selecting PnP/PCI Configurations on the main program screen displays this menu:

CMOS Setup Utility – Copyright (C) 1984 – 2001 Award Software
PnP/PCI Configurations

Reset Configuration Data	[Disabled]	Item Help
Resources Controlled by	[Auto(ESCD)]	Menu Level ► Default is Disabled. Select Enabled to reset Extended System Configuration Data (ESCD) when you exit Setup if you have installed a new add-on and the system reconfiguration has caused such a serious conflict that the OS cannot boot
x IRQ Resources	Press Enter	
PCI/VGA Palette Snoop	[Disabled]	
Assign IRQ For USB	[Enabled]	
INT Pin 1 Assignment	[Auto]	
INT Pin 2 Assignment	[Auto]	
INT Pin 3 Assignment	[Auto]	
INT Pin 4 Assignment	[Auto]	
INT Pin 5 Assignment	[Auto]	
INT Pin 6 Assignment	[Auto]	
INT Pin 7 Assignment	[Auto]	
INT Pin 8 Assignment	[Auto]	

- ~ ® ~ : Move Enter : Select +/-/PU/PD:Value: F10: Save ESC: Exit F1:General Help
F5:Previous Values F6:Fail-Safe Defaults F7:Optimized Defaults

Reset Configuration Data (Disabled)

If you enable this item and restart the system, any Plug and Play configuration data stored in the BIOS Setup is cleared from memory.

Resources Controlled By (Auto(ESCD))

You should leave this item at the default Auto(ESCD). Under this setting, the system dynamically allocates resources to Plug and Play devices as they are required.

If you cannot get a legacy ISA (Industry Standard Architecture) expansion card to work properly, you might be able to solve the problem by changing this item to Manual, and then opening up the IRQ Resources and Memory Resources submenus.

In the IRQ Resources submenu, if you assign an IRQ to Legacy ISA, then that Interrupt Request Line is reserved for a legacy ISA expansion card. Press <Esc> to close the IRQ Resources submenu.

In the Memory Resources submenu, use the first item Reserved Memory Base to set the start address of the memory you want to reserve for the ISA expansion card. Use the second item Reserved Memory Length to set the amount of reserved memory. Press <Esc> to close the Memory Resources submenu.

PCI/VGA Palette Snoop (Disabled)

This item is designed to overcome problems that can be caused by some non-standard VGA cards. This board includes a built-in VGA system that does not require palette snooping so you must leave this item disabled.

Assign IRQ For USB (Enabled)

Names the interrupt request (IRQ) line assigned to the USB on your system. Activity of the selected IRQ always awakens the system.

INT Pin1~8 Assignment (Auto)

Names the interrupt request (IRQ) line assigned to a device connected to the PCI interface on your system.

PC Health Status Option

On mainboards that support hardware monitoring, this item lets you monitor the parameters for critical voltages, critical temperatures, and fan speeds:

CMOS Setup Utility – Copyright (C) 1984 – 2001 Award Software
PC Health Status

Shutdown Temperature	[70° C/140° F]	Item Help
CPU Vcore		Menu Level ▶
1.80 V		
3.30 V		
5.00 V		
12.0 V		
2.5 V		
Voltage Battery		
Current System Temp		
Current CPU Temp		
CPU FAN Speed		
Chassis FAN Speed		
Power FAN Speed		

- : MoveEnter : Select +/-J/PD:Value: F10: Save ESC: Exit F1:General Help
F5:Previous Values F6:Fail-Safe Defaults F7:Optimized Defaults

Shutdown Temperature

Enables you to set the maximum temperature the system can reach before powering down.

System Component Characteristics

These fields provide you with information about the systems current operating status. You cannot make changes to these fields.

- CPU Vcore (CPU core voltage)
- Voltage Battery (battery voltage)
- Current System Temp (degrees Fahrenheit and Celsius)
- Current CPU Temp (degrees Fahrenheit and Celsius)
- CPU fan speed (in RPMs)
- Chassis FAN Speed (in RPMs)
- Power FAN Speed (in RPMs)

Frequency/Voltage Control

This item enables you to set the clock speed and system bus for your system. The clock speed and system bus are determined by the kind of processor you

have installed in your system.

CMOS Setup Utility – Copyright (C) 1984 – 2001 Award Software
Frequency/Voltage Control

CPU Clock Ratio	[Auto]	Item Help
Auto Detect PCI Clk	[Enabled]	Menu Level ▶
Spread Spectrum	[Enabled]	
CPU Host/3V66/PCI Clock	[Default]	

- - ® - : Move Enter : Select +/-/PU/PD:Value: F10: Save ESC: Exit F1:General Help
F5:Previous Values F6:Fail-Safe Defaults F7:Optimized Defaults

CPU Clock Ratio

Enables you to set the CPU clock. The CPU clock ratio times the CPU Host/PCI Clock should equal the core speed of the installed processor.

Example:

CPU Clock Ratio	8
CPU Host/PCI Clock	<u>x 100</u>
Installed CPU clock speed	800 MHz

Auto Detect PCI Clk (Enabled)

When this item is enabled, BIOS will disable the clock signal of free DIMM and PCI slots.

Spread Spectrum (Enabled)

If you enable spread spectrum, it can significantly reduce the EMI (Electro-Magnetic Interference) generated by the system.

CPU Host/3V66/PCI Clock (Default)

Use the CPU Host Clock to set the frontside bus frequency for the installed processor (usually 133 MHz, 100 MHz or 66 MHz).

Load Fail-Safe Defaults Option

This option opens a dialog box that lets you install fail-safe defaults for all appropriate items in the Setup Utility:

Press <Y> and then <Enter> to install the defaults. Press <N> and then <Enter> to not install the defaults. The fail-safe defaults place no great demands on the system and are generally stable. If your system is not functioning correctly, try installing the fail-safe defaults as a first step in getting your system working properly again. If you only want to install fail-safe defaults for a specific option, select and display that option, and then press <F6>.

Load Optimized Defaults Option

This option opens a dialog box that lets you install optimized defaults for all appropriate items in the Setup Utility. Press <Y> and then <Enter> to install the defaults. Press <N> and then <Enter> to not install the defaults. The optimized defaults place demands on the system that may be greater than the performance level of the components, such as the CPU and the memory. You can cause fatal errors or instability if you install the optimized defaults when your hardware does not support them. If you only want to install setup defaults for a specific option, select and display that option, and then press <F7>.

Set Password Option

This item can be used to install a password. To install a password, follow these steps:

1. Highlight the item Set Password on the main menu and press <Enter>.
2. The password dialog box appears.

Enter Password:

3. If you are installing a new password, type in the password. You cannot use more than eight characters or numbers. The Set Password item differentiates between upper and lower case characters. Press <Enter> after you have typed in the password. If you are deleting a password that is already installed press <Enter> when the password dialog box appears. You see a message that indicates that the password has been disabled.

PASSWORD DISABLED !!!
Press any key to continue . . .

4. Press any key. You are prompted to confirm the password:

Confirm Password:

5. Type the password again and press <Enter>, or press <Enter> if you are deleting a password that is already installed.
6. If you typed the password correctly, the password will be installed.

Save & Exit Setup Option

Highlight this item and press <Enter> to save the changes that you have made in the Setup Utility and exit the Setup Utility. When the Save and Exit dialog box appears, press <Y> to save and exit, or press <N> to return to the

main menu:

Exit Without Saving

Highlight this item and press <Enter> to discard any changes that you have made in the Setup Utility and exit the Setup Utility. When the Exit Without Saving dialog box appears, press <Y> to discard changes and exit, or press <N> to return to the main menu.

Note: If you have made settings that you do not want to save, use the "Exit Without Saving" item and press <Y> to discard any changes you have made.

This concludes Chapter 3. Refer to the next chapter for information on the software supplied with the mainboard.

Using the Mainboard Software

About the Software CD-ROM

The support software CD-ROM that is included in the mainboard package contains all the drivers and utility programs needed to properly run the bundled products. Below you can find a brief description of each software program, and the location for your mainboard version. More information on some programs is available in a README file, located in the same directory as the software.

Note: Never try to install software from a folder that is not specified for use with your mainboard.

Before installing any software, always inspect the folder for files named README.TXT, INSTALL.TXT, or something similar. These files may contain important information that is not included in this manual

Auto-installing under Windows 98

The Auto-install CD-ROM makes it easy for you to install the drivers and software for your mainboard.

Note: If the Auto-install CD-ROM does not work on your system, you can still install drivers through the file manager for your OS (for example, Windows Explorer). Refer to Utility Folder Installation Notes later in this chapter.

The support software CD-ROM disc loads automatically under Windows 98. When you insert the CD-ROM disc in the CD-ROM drive, the autorun feature will automatically bring up the install screen. The screen has three buttons on it, Setup, Browse CD and Exit.

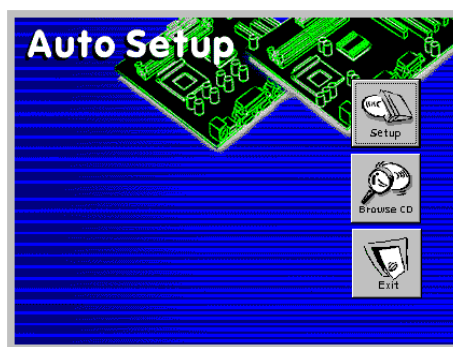

Note: If the opening screen doesn't appear, double-click the file "setup.exe" in the root directory.

Setup

Click the Setup button to run the software installation program. Select from the menu which software you want to install.

Browse CD

The Browse CD button is the standard Windows command that allows you to open Windows Explorer and show the contents of the support CD.

Before installing the software from Windows Explorer, look for a file named README.TXT, INSTALL.TXT or something similar. This file may contain important information to help you install the software correctly.

Some software is installed in separate folders for different operating systems, such as DOS, WIN NT, or WIN98/95. Always go to the correct folder for the kind of OS you are using.

To install the software, execute a file named SETUP.EXE or INSTALL.EXE by double-clicking the file and then following the instructions on the screen.

Exit

The Exit button closes the Auto Setup window.

Running Setup

Follow these instructions to install device drivers and software for the mainboard:

1. Click **Setup**. The installation program begins:



Note: The following screens are examples only. The screens and driver lists will be different according to the mainboard you are installing.

The mainboard identification is located in the upper left-hand corner.

2. Click **Next**. The following screen appears:

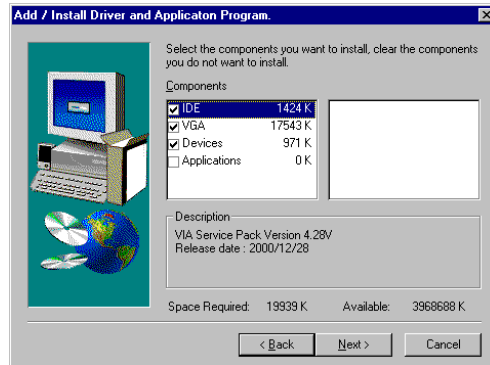

3. Check the items you want to install. The default options are recommended.
4. Click **Next** to run the Installation Wizard. An item installation screen appears:

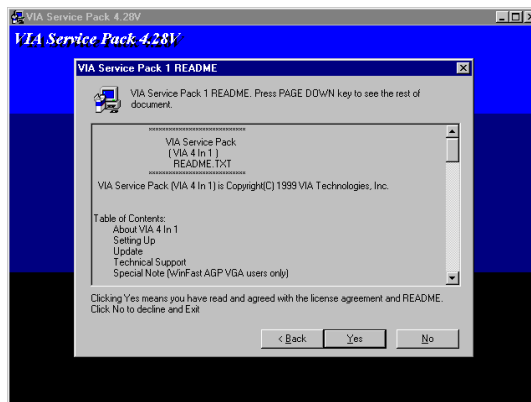

5. Follow the instructions on the screen to install the items. Drivers and software are automatically installed in sequence. Follow the onscreen instructions, confirm commands and allow the computer to restart after each installation.

Utility Software Reference

All the utility software available on the CD-ROM is Windows compliant. It is provided only for the convenience of customers. The following software is furnished under license and may only be used or copied in accordance with the terms of the license.

Note: The software in these folders is subject to change at anytime without prior notice. Please refer to the support CD for available software.

Award Flash Memory Utility

This utility enables you to erase the system BIOS stored on a Flash Memory chip on the mainboard, and lets you copy an updated version of the BIOS to the chip. Proceed with caution when using this program. If you erase the current BIOS and fail to write a new BIOS, or write a new BIOS that is incorrect, your system will malfunction. Refer to Chapter 3, Using BIOS for more information.

PC-CILLIN

The PC-CILLIN software program provides anti-virus protection for your system. This program is available for Windows 2000/ME/98SE and Windows NT. Be sure to check the readme.txt and install the appropriate anti-virus software for your operating system.

We strongly recommend users to install this free anti-virus software to help protect your system against viruses.

Note: Update your virus software regularly to protect against new viruses.

MediaRing Talk – Telephony Software

To install the MediaRing Talk voice modem software for the built-in modem, run MRTALK-SETUP72.EXE from the following directory:

UTILITYMEDIARING TALK

Super Voice – Fax/Modem Software

To install the Super Voice voice, fax, data communication application for use with the built-in fax/modem, run PICSHELL.EXE from the following directory:

UTILITYSUPER VOICE

CD Ghost

The CD Ghost software enables you to create a virtual cabinet of CD-ROM drives on your system to help you categorize and organize your CD collection. A user-friendly interface assists you in quickly creating images of both CDs and DVDs onto your system. To install the software, run SETUP.EXE from the following directory:

\UTILITY\CDGHOST\ENG\CDGHOST

Recovery Genius

The Recovery Genius software program is an innovative windows application system that protects your Hard Disk Drive from virus intrusion, accidental deletions, and system corruption. To install the Recovery Genius software program run SETUP.EXE from the following directory

\UTILITY\RECOVERY GENIUS\ENG\RECOVERYGENIUS

Language Genius

The Language Genius is a software-based product that helps you to learn new languages. To install the Language Genius software program run SETUP.EXE from the following directory

\UTILITY\LANGUAGE GENIUS\ENGLANGUAGEGENIUS

PageABC

The PageABC application software enables you to create your own home page. To install the PageABC, run SETUP.EXE from the following directory:

\UTILITY\PageABC

This concludes Chapter 4.