



Item Checklist

This item checklist is only available for retail market. Completely check your package, If you discover damaged or missing items, contact your retailer.

- P41865A series mainboard
- QDI Utility CD
- User's manual
- IDE ribbon cable
- Floppy ribbon cable
- I/O shield
- SATA signal cable(option)
- SATA power cable(option)
- Cable with bracket for USB Connectors (option)
- Cable with bracket for SPIDF Connectors (option)



The information in this document is subject to change in order to improve reliability, design, or function without prior notice and does not represent a commitment on the part of this company. In no event will we be liable for direct, indirect, special, incidental, or consequential damages arising out of the use or the possibility of such damages.

All trademarks are the property of their respective owners.

If you need any further information, please visit our web-site: "www.qdigrp.com".

Declaration of conformity



QUANTUM DESIGNS(HK) LTD.

**20th Floor, Devon House, Taikoo Place, 979 King's Road,
Quarry Bay, Hong Kong**

declares that the product

Mainboard
P4I865G /P/PEA series

is in conformity with

(reference to the specification under which conformity is declared in
accordance with 89/336 EEC-EMC Directive)

- EN 55022 Limits and methods of measurements of radio disturbance characteristics of information technology equipment
- EN 50081-1 Generic emission standard Part 1:
Residential, commercial and light industry
- EN 50082-1 Generic immunity standard Part 1:
Residential, commercial and light industry

European Representative:

QDI COMPUTER (UK) LTD

QDI COMPUTER (SCANDINAVIA) A/S

QDI SYSTEM HANDEL GMBH

QDI EUROPE B.V.

QDI COMPUTER (FRANCE) SARL

QDI COMPUTER HANDELS GMBH

LEGEND QDI SPAIN S.L.

QDI COMPUTER (SWEDEN) AB

Signature :

Place / Date :

HONG KONG/2003

Printed Name :

Xu Wenge

Position/ Title :

Assistant President

Declaration of conformity



Trade Name: QDI Computer (U . S . A .) Inc.
Model Name: **P4I865G/P/PEA**
Responsible Party: QDI Computer (U . S . A .) Inc.
Address: 41456 Christy Street
Fremont, CA 94538
Telephone: (510) 668-4933
Facsimile: (510) 668-4966

Equipment Classification: FCC Class B Subassembly
Type of Product: Mainboard
Manufacturer: Quantum Designs (HK) Inc.
Address: 20th Floor, Devon House, Taikoo Place
979 King's Road, Quarry Bay, HONG
KONG

Supplementary Information:

This device complies with Part 15 of the FCC Rules. Operation is subject to the following two conditions : (1) this device may not cause harmful interference, and (2) this device must accept any interference received, including interference that may cause undesired operation.

Tested to comply with FCC standards.

Signature : 

Date : 2003

CONTENTS

Chapter 1 Introduction

Introduction	1
Key Features	2

Chapter 2 Installation Instructions

External Connectors	7
PS/2 Keyboard/Mouse Connectors	7
USB1, USB2 and 1394 Connectors	7
USB3, USB4 and LAN Connectors	8
Line-in jack, Microphone-in jack, Speaker-out jack	8
5.1-channel Audio.....	9
Parallel Port, Serial Port Connectors.....	10
ATX12V Power Supply Connector & Power Switch (POWER SW)	11
Front Panel Connector	12
Hard Disk LED Connector (HD_LED)	12
ACPI LED Connector	12
Speaker Connector (SPEAKER)	12
Power LED Connector (PWR_LED)	12
Reset Switch	12
GREENLED Connector	12
Hardware Green Connector	12
Key Lock Connector	12
USB5,6;USB7,8	14
Fan Connectors (CPUFAN, CHSFAN,SYSTEMFAN)	14
Infrared Header (IrDA)	15
Wake-Up On LAN (WOL)(-L)(-K)	15
Audio Connectors (CD_IN,AUX_IN)	16
1394 Connector(Optional)(-F)	16
Audio Interface	17
SPDIF/6CH BRACKET Connector	18
SCR(Smart Card Reader)	18
1394(Optional) and LAN(Optional) MAC Label	19
Serial ATA Connector	19
Diagnosis LED	20
HYPER_Threading	20

Jumper Settings	21
Clear CMOS (JP1)	22
BIOS-Protection Jumper (JP2)	23

Chapter 3 BIOS Description

Utility Support	24
AWDFLASH.EXE	24
AWARD(Phoenix) BIOS Description	25
Entering Setup	25
Load Optimized Defaults	25
Standard CMOS Features Setup	25
BIOS Features Setup	29
Advanced BIOS Features Setup	30
Advanced Chipset Features Setup	32
Integrated Peripherals	34
Power Management Setup	39
PNP/PCI Configuration Setup	43
PC Health Status	44
Frequency/Voltage Control	46
Password Setting	47
Boot with BIOS defaults	47

Appendix

QDI Utility CD	48
Norton AntiVirus	48
SpeedEasy	49
Pro-LogoEasy	50
Pro-StepEasy	52
Pro-UpdateEasy	55
BootEasy	56
BIOS-ProtectEasy	57
QDI BootEasy(German)	58
P4I865G/P/PEA(Spanish)	59
P4I865G/P/PEA(French)	62
P4I865G/P/PEA(Italian)	66
Using 4/6-Channel Audio	69

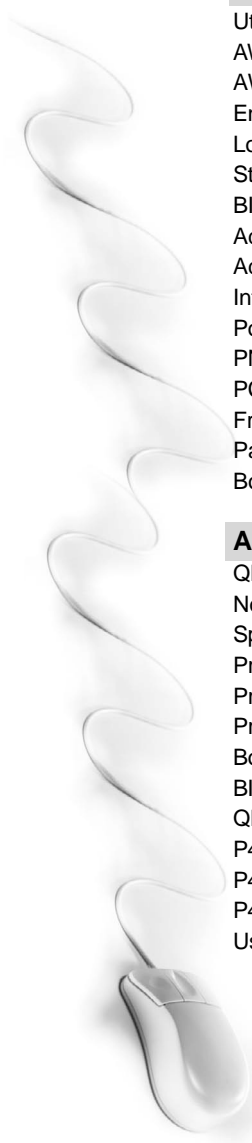

 **Note:**

This manual is suitable for mainboards of P4I865MA series. Each mainboard is carefully designed for the PC user who wants diverse features.

- 6A: with onboard 6 Channel Audio**
- F: with onboard 1394**
- K: with onboard 1G LAN**
- L: with onboard 10/100M LAN**
- R: with Raid**

⚠ Caution

Be sure to unplug the AC power supply before adding or removing expansion cards or other system peripherals, especially the memory devices, otherwise your mainboard or the system memory might be seriously damaged.

⚠ Caution

Be sure to add some Silicone Grease between the CPU and the heatsink to keep them fully contacted to meet the heat sink requirement.

⚠ Caution

We cannot guarantee your system running properly under overclocking. It depends on the overclocking ability of your peripherals.

-- This page is intentionally left blank --

Chapter 1

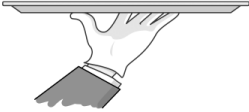

Introduction

P4I865G/P/PEA series of mainboards utilize (Intel® 865G/P/PE +ICH5/5R)chipset, providing a fully compatible, high performance and cost-effective ATX platform. The new integrated technologies, together with AC'97 audio, onboard VGA connector(supported on P4I865GA only), integrated LAN(optional), 4 USB 2.0 ports (Expanded capabilities for eight USB 2.0 ports), ATA100/66/33 and SATA, give customers an advanced, multimedia solution at reasonable price. It provides 400/533/800MHz(supported on P4I865G/PEA only) host bus speed to support Intel® Pentium® 4 socket 478 processors and the largest DDR memory capacity is up to 4GB. It also provides advanced features such as Wake up by USB devices, Wake-on-LAN, ACPI function. Suspend to RAM, the optimal implementation of the Advanced Configuration and Power Interface (ACPI) specification, makes the PC's power consumption drop to the lowest possible level and enable quick wake up.





Key Features

Form factor

- ATX form factor of 304 mm x 243mm

Microprocessor

- Supports for Intel® Pentium®4 (Northwood) socket 478 processors at 1.6/1.8/2.0/2.2/2.4GHz at 400MHz FSB and above.
- Supports Intel® Celeron® Socket 478 processors at 2.0/2.1GHz at 400MHz FSB and above.
- Supports Intel® Pentium®4(Northwood) Socket 478 processors at 2.26/2.4/2.53/2.66/2.8/3.06GHz at 533MHz FSB and above.
- Supports Intel® Pentium®4((Northwood) Socket 478 processors at 2.4C/2.6C/2.8C GHz at 800MHz FSB and above.
- Supports Intel® Prescott Socket 478 processors at 3.0G/3.2GHz and above at 800MHz FSB (Supported on P4I865G/PEA Only)(Optional)
- Supports Hyper-threading technology.

Chipset

P4I865G/P/PEA Family

2

- Intel® Springdale Chipset: Intel® 865G/P/PE(NorthBridge)+ICH5/5R (SouthBridge)

System memory

- Provides four 184-pin DDR DIMM Sockets
- Supports for DDR266/DDR333/DDR400(Supported on P4I865G/PEA Only)
- Supports for 128/256/512Mb technology up to 4GB
- Supports Dual channel DDR(rise the same type DDR to DIMM1,3 or DIMM2, 4, Dual channel model transfer rate get to highest, as DDR400 the transfer rate is 6.4MBps)

NOTES: Configured FSB800 CPU and DDR333, memory frequency is 320MHz

Onboard IDE

- Supports for Independent timing of up to 4 drives
- Supports for Ultra ATA 100/66/33, PIO mode
- Two fast IDE interfaces supporting four IDE devices including IDE hard disks and CD-ROM/DVD-ROM drives

Onboard Graphics (Supported on P4I865GA only)

- Integrated Intel Extreme Graphics 2D/3D graphics accelerator
- Integrated 350MHz RAMDAC
- Provides VGA output connector
- Provides 32bit true color support for high resolution texture



- Provides new 3D features create real-life environment and character effects
- AGP 3.0 Interface with 4X or 8X data transfers and 4X or 8X fast write

Onboard Serial ATA

- Supports hot-plug
- Two SATA devices including SATA HDD and CDROM/DVDROM devices
- 150Mbps transfer rate
- Supports Raid0,Raid1(-R)(optional)

Onboard 1394 (Optional) (-F)

- Supports hot-plug
- Supports 400Mbps transfer rate
- Two 1394 devices including HDD and CDROM/DVD ROM devices(Optional)
- PC link easy under WinMe or WinXP

Onboard LAN (Optional)

- 10/100 Mbit/sec Ethernet support(-L)
- LAN interface built-in on board
- 10M/100M/1G LAN interface (Optional) (-K)

USB 2.0 Ports

- Supports hot-plug
- One EHCI Controller and four UHCI Controllers (Expanded capabilities for eight, USB 2.0 ports)
- USB 2.0 compliant, operates at 480Mbps, about 40X times faster than USB 1.1 which currently works at a snails pace of just 12Mbps
- Supports wake-up from S1 (Power on suspend), S3(Suspend to RAM)

Onboard Audio

- AC'97 2.2 Specification Compliant
- Provides onboard Line-in Jack, Microphone-in Jack, Speaker-out Jack with onboard amplifier
- Supports S/PDIF output/input
- Supports 5.1 channels Audio

Onboard I/O

- One floppy port supports up to two 3.5" or 5.25" floppy drives with 360K/720K/1.2M/1.44M/2.88M format
- One high speed 16550 compatible UARTs (COM1/COM2/COM3/COM4 selective) with 16 byte send/receive FIFO
- One parallel port supports SPP/EPP/ECP mode
- Infrared interface, Smart Card Reader interface (Optional)
- All I/O ports can be enabled/disabled in the BIOS setup



BIOS

- Licensed advanced AWARD(Phoenix) BIOS, supports flash ROM, plug and play ready
- Supports IDE CDROM/SCSI or USB device boot up
- Supports USB ports and one 1394 port

Green function

- Supports ACPI (Advanced Configuration and Power Interface)
- Supports ACPI power status: S0 (full-on), S1 (power on suspend), S3 (suspend to RAM), S4(suspend to Disk,depends on OS) and S5 (soft-off)

Expansion slots

- 5 PCI slots
- 1AGP slot
- 1CNR slot (Optional)

Advanced features

- PCI 2.3 Specification Compliant.
- Supports Windows 98/2000/ME/XP soft-off.
- Supports Wake-on-LAN .
- Supports Keyboard Password Power-on Funtion.
- Supports system monitoring(monitors CPU and system temperatures, System. voltages, fan speed)
- Supports QDI Utility, eg: SpeedEasy, Pro-StepEasy, Pro-LogoEasy, Pro-UpdateEasy, BootEasy, BIOS-ProtectEasy



Main Expansion Slots and Connectors

Slot/Port (Quantity)	Description
PCI(5)	PCI slots
IDE(2)	IDE ports
FLOPPY(1)	Floppy Drive port
DDR(4)	DDR sockets
USB Port(4)	USB connectors
USB Header(2)	USB Headers
UART(1)	UART connector
PARALLEL(1)	Parallel connector
IrDA(1)	IrDA connector
S/PDIF-IN(1)	Connector
S/PDIF-OUT(1)	Connector
Front-Audio(1)	Connector
1394 Connector (1)	Connector
1394 Header(1)	1394 Header
SATA(2)	Connector
Front-COM(1)	Connector
CNR(1)	CNR slot (Optional)
Smart Card Reader (1)	Connector(Optional)





Chapter 2

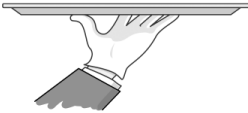

Installation Instructions

This section covers External Connectors and Jumper Settings. Refer to the mainboard layout chart for locations of all jumpers, external connectors, slots and I/O ports. Furthermore, this section lists all necessary connector pin assignments for your reference. The particular state of the jumpers, connectors and ports are illustrated in the following figures. Before setting the jumpers or inserting these connectors, please pay attention to the directions.



External Connectors

PS/2 Keyboard/Mouse Connector

PS/2 keyboard connector is for the usage of PS/2 keyboard. If using a standard AT size keyboard, an adapter should be used to fit this connector. PS/2 mouse connector is for the usage of PS/2 mouse.

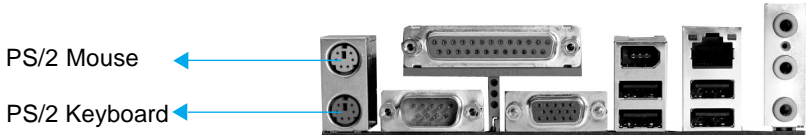

External Connectors for P4I865GA

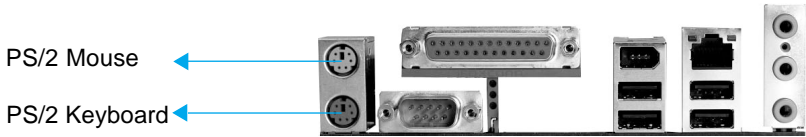

External Connectors for P4I865 PEA/PA

USB1, USB2 and 1394 Connectors

Two USB ports are for connecting USB devices. The 1394 connector is for connecting 1394 devices.

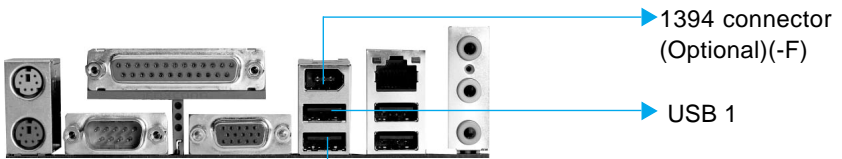

External Connectors for P4I865GA



External Connectors for P4I865 PEA/PA





USB3, USB4 and LAN Connectors

Two USB ports are for connecting USB devices. The RJ-45 connector is for onboard LAN.

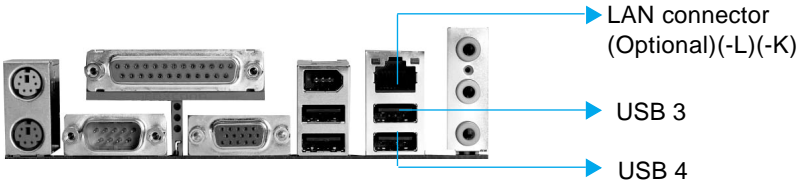

External Connectors for P4I865GA

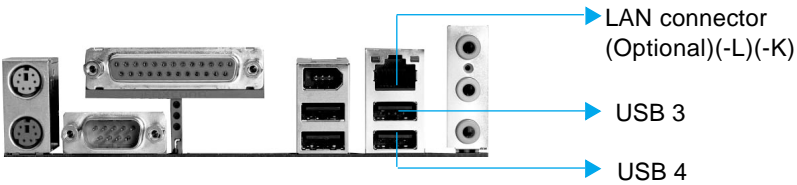

External Connectors for P4I865 PEA/PA

Warning:

Be sure to unplug the AC power supply before adding or removing expansion cards or other system peripherals, otherwise your mainboard and expansion cards might be seriously damaged.

Line-in jack, Microphone-in jack, Speaker-out jack

The Line-in jack can be connected to devices such as a cassette or minidisc player to playback or record. The Microphone-in jack can be connected to a microphone for voice input. The Speaker-out jack allows you to connect speakers or headphones for audio output from the internal amplifier.





External Connectors for P4I865GA



External Connectors for P4I865 PEA/PA

5.1-Channel Audio

This mainboard utilizes ALC650 chip providing 5.1-Channel Audio. 5.1-Channel Audio consists of Front Left, Front Right, Rear Left, Rear Right, Center and Woofer for a complete surround sound effect .when 5.1-channel audio is available, the front Left&Right jack can be connected to the Front speakers, the Rear Left & Right jack can be connected to the rear speakers and the center & Woofer jack can be connected to the center speaker and woofer.

Microphone function is offered by FP_AUDIO Connector on the mainboard now. If you set 2-channel audio mode on -6A or -6AL mainboard, you can connect two speakers to the front Left&Right jack , at the same time use the Rear Left&Right jack as Line-in jack, and use the Center&Woofer jack as Microphone-in jack.

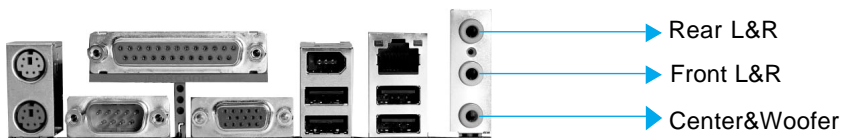

External Connectors for P4I865GA

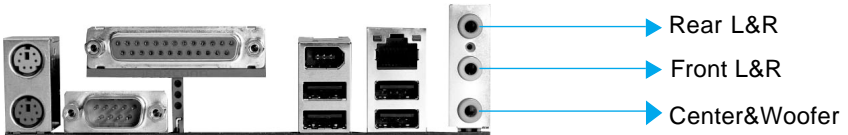

External Connectors for P4I865 PEA/PA



Parallel Port, Serial Port Connectors

The parallel port connector can be connected to a parallel device such as a printer. The serial port UART1 connector can be connected to a serial port device such as a serial port mouse. You can enable/disable them and choose the IRQ or I/O address in “Integrated Peripherals” from AWARD BIOS SETUP. The VGA output connector is for output to a VGA-Compatible device.

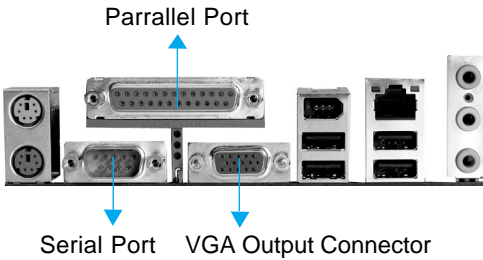

External Connectors for P4I865GA

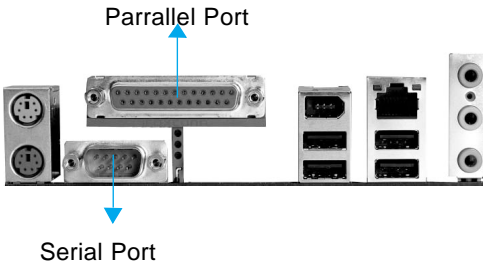

External Connectors for P4I865 PEA/PA



ATX12V Power Supply Connector & Power Switch (POWER SW)

P4I865G/P/PEA serial mainboard must use ATX 12V power supply. Be sure to connect the power supply plug to this connector in its proper orientation. The power switch (POWER SW) should be connected to a momentary switch. When powering up your system, first turn on the mechanical switch of the power supply (if one is provided), then push once the power switch. When powering off the system, you needn't turn off the mechanical switch, just Push once the power switch.

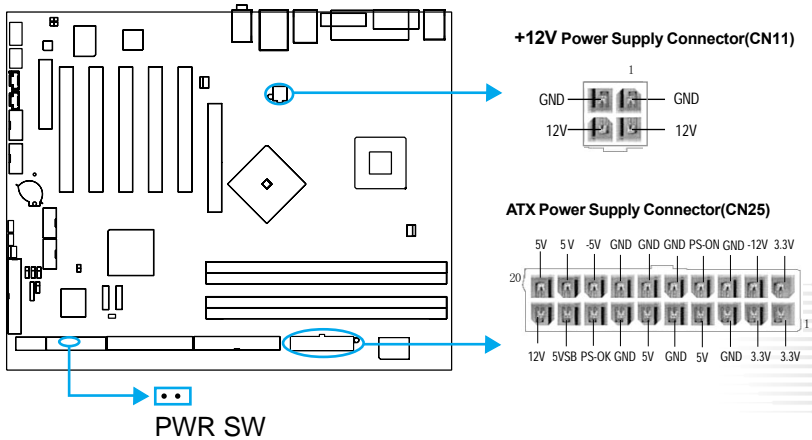

Note:

If you change “Soft-off by PWR-BTTN” from default “Instant-off” to “Delay 4 Sec” in the “POWER MANAGEMENT SETUP” section of the BIOS, the power switch should be pressed for more than 4 seconds before the system powers down.



Front Panel Connector:CN33

Hard Disk LED Connector (HD LED)

The connector connects to the case's IDE indicator LED indicating the activity status of IDE hard disk. The connector has an orientation. If one way doesn't work, try the other way.

ACPI LED Connector (ACPI LED)

The ACPI LED is a dual-color light with three pins. Pin1 and Pin2 drive different color lights. If Pin1 drives the orange light, then, Pin2 drives the green light, the following status will come out. When the system is in S0 status, the LED is green on. When the system is in S1 status, the LED is green blink. When the system is in S3 status, the LED is yellow on. When the system is in S4, S5 status, the LED is off.

Speaker Connector (SPEAKER)

The connector can be connected to the speaker on the case.

Power LED Connector(PWR LED)

12

When the system is in S0 status, the LED IS on. When the system is in S1 status, the LED IS blin; When the system is in S3, S5 status, the LED IS off.

Reset Switch(RESET)

The connector connects to the case's reset switch. Press the switch once, the system resets.

GREEN LED Connector(GREEN LED)

When the system is in S0, S1, S5 status, the LED IS off. When the system is in S3 status, the LED is on.

Hardware Green Connector(SLEEP SW)

Push once the switch connected to this header, the system enters suspend mode.

Key Lock Connector(KEYLK)

The connctor can be connected to the keyboard lock switch on the case for locking the keyboard.



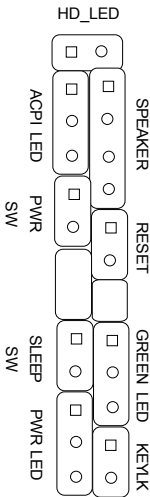
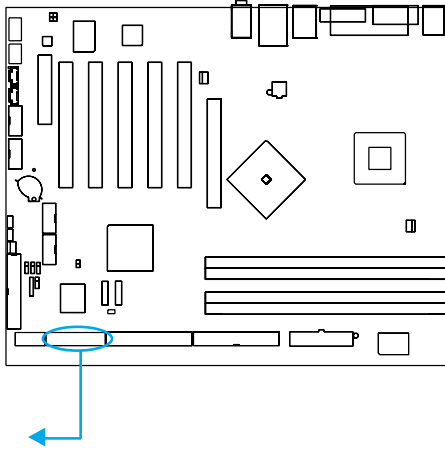

CN33

HDD LED(+)		HDD LED(-)	
ACPI LED	ORANGE(-)	VCC	SPEAKER
	GREEN(-)	GND	
	LED+(VCC)	NC	
PWR SW	POWER	SPKDATA	RESET
	GND	RESET	
	EMPTY	GND	
SLEEP SW	EMPTY	EMPTY	GREEN LED
	SLEEP	LED+	
	GND	LED-	
PWR LED	LED+	LED-	KEYLK
	LED-	GND	
	LED-	KEYLOCK	





USB5,6 ;USB7,8

Besides USB1,2,3,4 on the back panel, the series of mainboards also have two 10-pin headers on board which may connect to front panel USB cable (optional) to provide additional four USB ports.

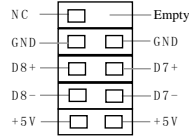
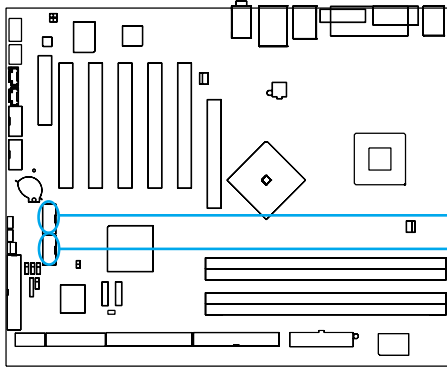

USB7, 8 (USB-HDER 2)

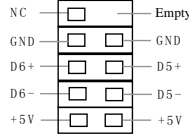

USB5, 6 (USB-HDER 1)

14

Fan Connectors (CPUFAN, CHSFAN,SYSTEMFAN)

The fan speed of CPUFAN and CHSFAN can be detected and viewed in “PC Health” section of the CMOS SETUP. These fans will be automatically turned off after the system enters suspend mode.

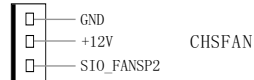
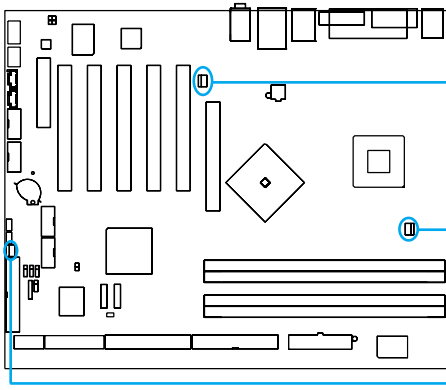

CN9



CN15



CN40



Infrared Header (IrDA)

This connector supports wireless transmitting and receiving device. Before using this function, configure the settings for IR Address, IR Mode and IR IRQ from the “INTEGRATED PERIPHERALS” section of the CMOS SETUP.

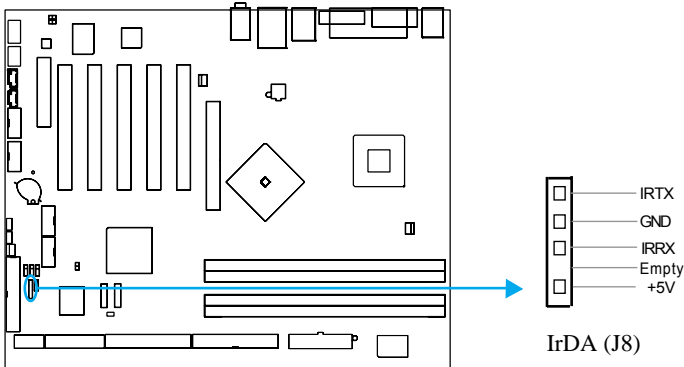

Wake-Up On LAN (WOL)(-L)(-K)

Through the Wake-Up On LAN function, a wake event occurring from the network can wake up the system. If this function is to be used, please be sure an ATX12V power supply of which 5VSB line is capable of delivering current at least 720mA, and a LAN adapter which supports this function is used. Then connect this header to the relevant connector on the LAN adapter, set “Wake up on LAN” as Enabled in the “POWER MANAGEMENT SETUP” section of the CMOS SETUP. Save and exit, then boot the operating system once to make sure this function takes effect.

15

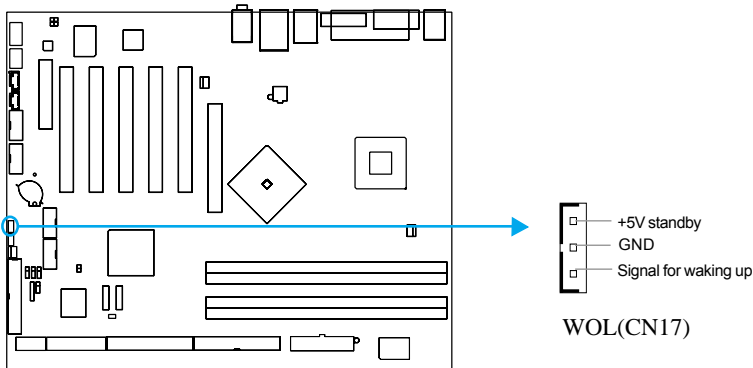



Audio Connectors (CD_IN,AUX_IN)

CD_IN,AUX_IN is Sony standard CD audio connectors, it can be connected to a CD-ROM drive through a CD audio cable.

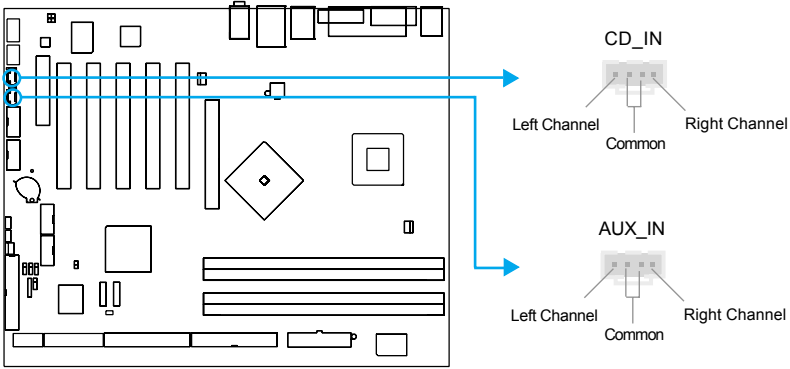

16

1394 Connector(Optional)(-F)

Connect your 1394 device(s) to the onboard 10-pins connector.

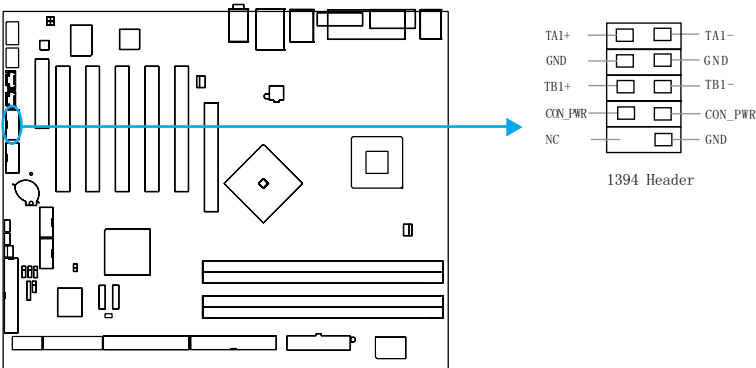

Audio Interface

The audio interface provides two kinds of audio output choices: the FrontAudio and the RearAudio. Their priority level is as sequence. When the FrontAudio is available, the RearAudio will be cut off. When the FrontAudio is absent, Pin5 and Pin6, Pin9 and Pin10 must be short connected.

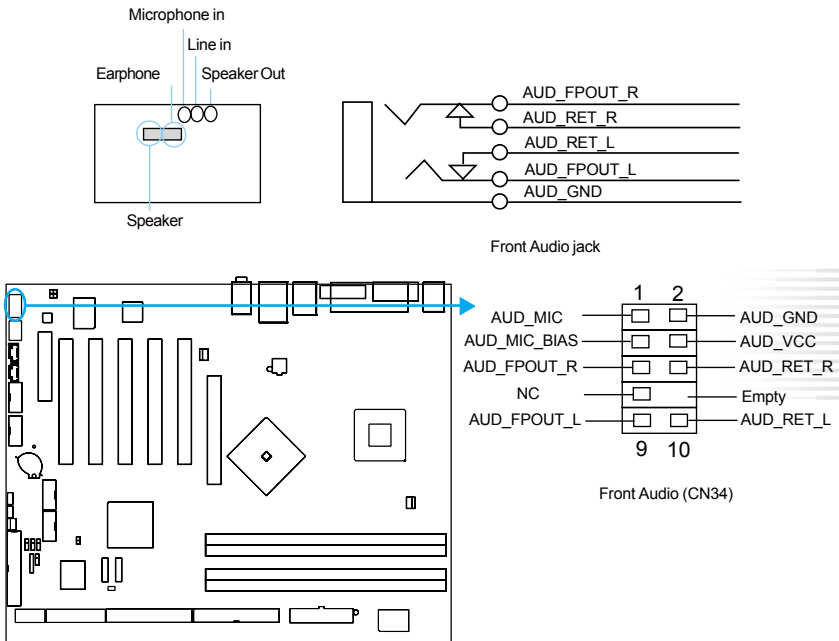



SPDIF/6CH_BRACKET Connector

The SPDIF/6CH_BRACKET output is capable of providing digital audio or 6 channel to external speakers or compressed AC3 data to an external Dolby digital decoder. And only one exists on one mainboard.

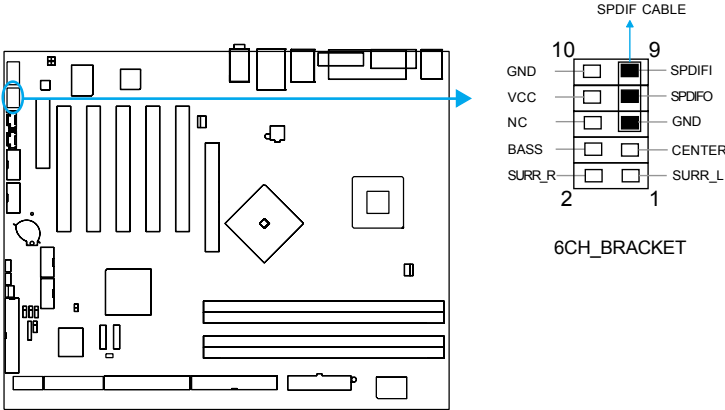

SCR(Smart Card Reader)(Optional)

18

SCR built-in on Winbond 83637HF I/O chipset, utilize the standard serial interface control the signals exchange and digital transfer between the connectors and SCR Card. SCR can apply in the GSM, ID bank system. SCR can provides clock for ICC (Integrated Circuit Card) without clock as for itself. Before using this function , set " UART's Mode's Select" as SCR in the " INTEGRATED PERIPHERALS" section of the CMOS SETUP.

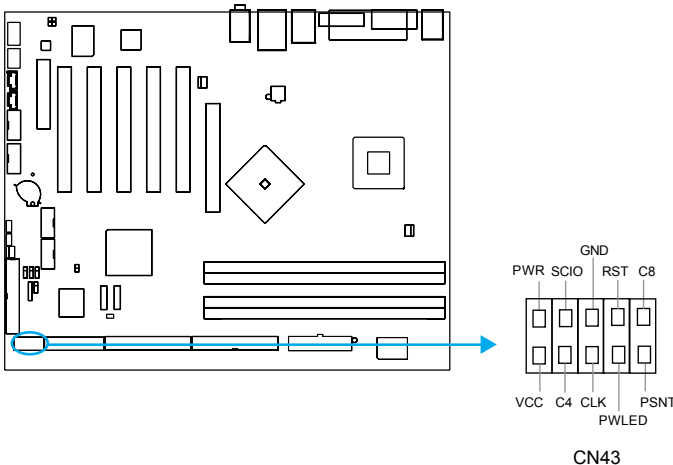

1394(Optional) and LAN(Optional) MAC Label

1394 MAC label is 16 digits,example:xxxxxxxxxxxxxxxx

LAN MAC label is 12 digits,example:EA=xxxxxxxxxxxx

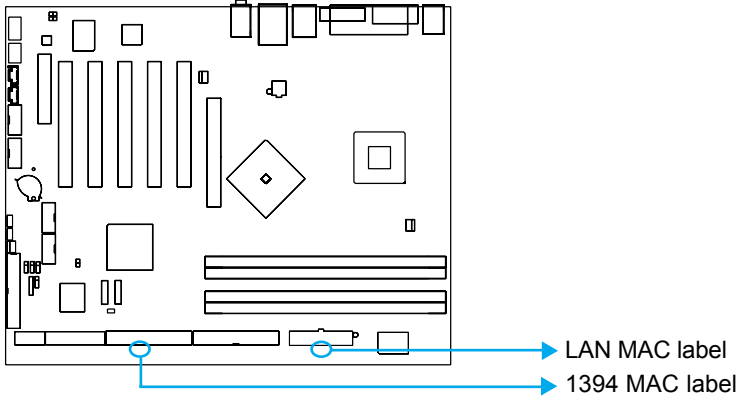

Serial ATA Connector

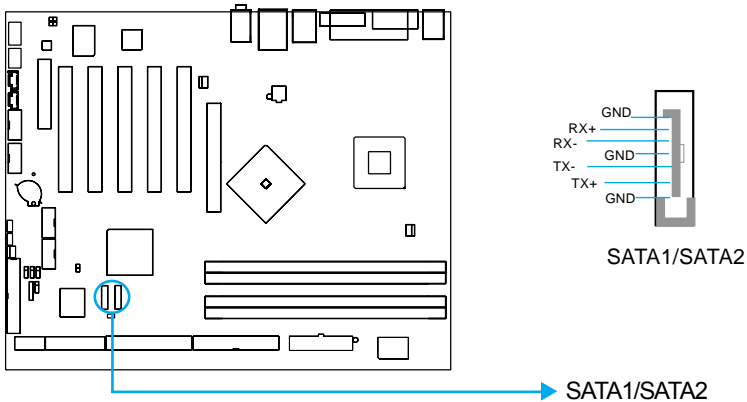



Diagnosis LED

During the power on course , five LEDs is used for indicateng that system start-up course are bright in proper order , please consult the below table to judge the system status.



Hyper-Threading



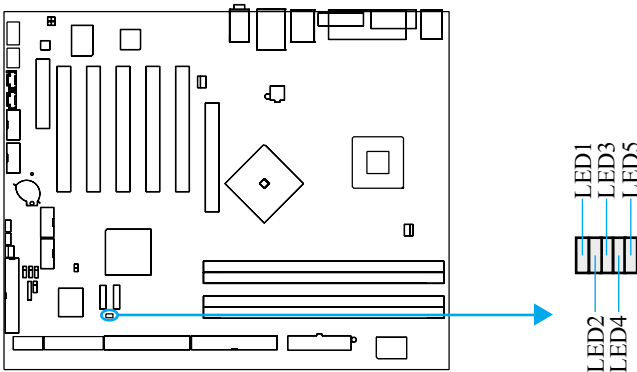



If your use Hyper-Threading CPU,after five LEDs in proper order bright in system start-up course, that the five lights shine at the same time indicates system readiness

LED1	LED2	LED3	LED4	LED5	STATUS
FLASH	OFF	OFF	OFF	OFF	CPU or BIOS Chipset is not properly installed or is damaged
ON	OFF	OFF	OFF	OFF	System Detect CPU and Initialize Chipset
OFF	ON	OFF	OFF	OFF	System Detect Memory
OFF	OFF	ON	OFF	OFF	System Initialize PCI Device
OFF	OFF	OFF	ON	OFF	System Detect Clock Generator
OFF	OFF	OFF	OFF	ON	System Detect Video and load Video BIOS
ON	ON	ON	ON	ON	Hyper-Threading be ready



Jumper Settings

Jumpers are located on the mainboard, they are clear CMOS jumper BIOS write protection Jumper etc. Pin 1 for all jumpers are located on the side with a “1” mark (Pin1-- 1 ), referring to the mainboard's silkscreen. Jumpers with three pins will be shown as  to represent pin1 & pin2 (“1-2”) closed and  to represent pin2 & pin3 (“2-3”) closed.

Jumper	Symbol	Description	Represent
		1 – 2	set pin1 and pin2 closed
		2 – 3	set pin2 and pin3 closed
		close	set the pins closed
		open	set the pins opened



Clear CMOS (JP1)

If you want to clear CMOS, unplug the AC power supply first, close JCC (pin1 & pin2) once, set JCC back to the normal status with pin2 & pin3 connected, then power on the system.

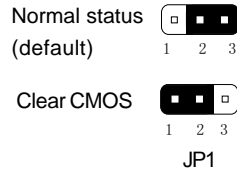
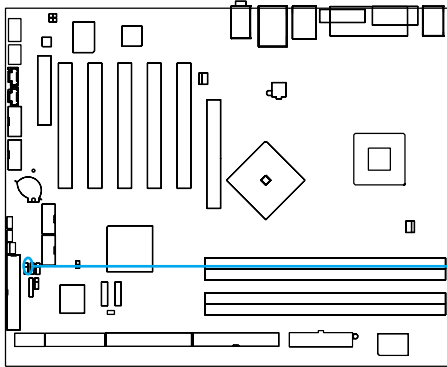

(Unplug the AC power supply)

Notes:

- 1. Be sure to plug off AC power supply before Clearing CMOS
- 2. Be sure to power off system before clearing CMOS



BIOS-Protection Jumper (JP2)

The BIOS of the mainboard is inside the FWH. If the jumper JP2 is set as closed (Pin1&Pin2), the system BIOS is protected from being attacked by serious virus such as CIH virus, you will be unable to flash the BIOS to the mainboard. However in this status .

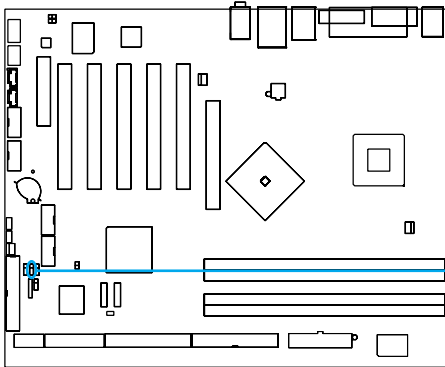

Flash Write	1	
Protect	2	
Disabled	3	

JP2

Flash Write	1	
Protect	2	
Enabled	3	

(default) JP2

Setting the jumper JP2 as open (Pin2&Pin3 default), meanwhile disabling the "Flash Write Protect" item in BIOS, allows you to flash the BIOS to the Flash ROM.

The DMI (Desktop Management Interface) system information such as the CPU type/speed, memory size, and expansion cards will be detected by the onboard BIOS and stored in the flash ROM. Whenever the system hardware configuration is changed, DMI information will be updated automatically.



Chapter 3

BIOS Description

Utility Support

AWDFLASH.EXE

This is a flash memory write/read utility used for the purpose of upgrading your BIOS when necessary. Before doing so, please note:

- We strongly recommend you only upgrade BIOS when encounter problems.
- Before upgrading your BIOS, review the description below to avoid making mistakes, destroying the BIOS and resulting in a non-working system.

When you encounter problems, for example, you find your system does not support the latest CPU released on our current mainboard, you may therefore upgrade the BIOS, please don't forget to set JP8 as open(pin2&pin3) and disable the "Flash Write Protect" item in AWARD BIOS CMOS Setup first.

Follow the steps exactly for a successful upgrade.

1. Create a bootable system floppy diskette by typing Format A:/s from the DOS prompt under DOS6.xx or Windows 9x environment.
2. Copy AWDFLASH.EXE (version>=8.23A) from the directory \Utility located on QDI Mainboard Utility CD onto your new bootable diskette.
3. Download the updated BIOS file from the Website (<http://www.qdigrp.com>). Please be sure to download the suitable BIOS file for your mainboard.
4. Decompress the file downloaded, copy the BIOS file (xx.bin) onto the bootable diskette, and note the checksum of this BIOS which is located in readme file.
5. Reboot the system from the bootable diskette created.
6. Then run the AWDFLASH utility at the **A:** prompt as shown below:
A:\AWDFLASH xxxx.bin

If you require more detailed information concerning AWDFLASH Utility, for example, the different usage of parameters, please type A:\>AWDFLASH /?

Note:

1. *Follow the instruction through the process. Don't turn off power or reset the system until the BIOS upgrade has been completed.*
2. *AWDFLASH.EXE (version>=8.23F) utility must be used to upgrade the mainboard family BIOS instead of QDI flash utility.*
3. *BIOS version will update constantly. The following BIOS screens and descriptions are for reference purposes only and may not reflect your BIOS screens exactly.*



AWARD(Phoenix) BIOS Description

Entering Setup

Power on the computer, when the following message briefly appears at the bottom of the screen during the POST (Power On Self Test), press key to enter the AWARD BIOS CMOS Setup Utility.

Press to enter SETUP

Once you have entered, the Main Menu (Figure 1) appears on the screen. The main menu allows you to select from twelve setup functions and two exit choices. Use the arrow keys to select among the items and press the <Enter> key to accept or enter the sub-menu.

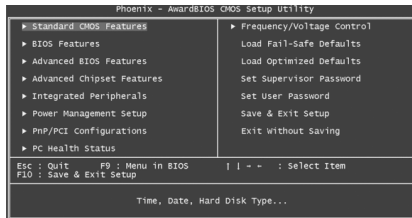

Main Menu

Load Optimized Defaults

The Optimized Defaults are common and efficient. It is recommended users load the optimized defaults first, then modify the needed configuration settings.

Standard CMOS Features Setup

The basic CMOS settings included in “Standard CMOS Features” are Date, Time, Hard Disk Drive Types, Floppy Disk Drive Types, Memory status and VGA etc. Use the arrow keys to highlight the item, then use the <PgUp> or <PgDn> keys to select the value desired in each item.





Standard CMOS Setup Menu

For the items marked, press enter, a window will pop up as shown below. You can view detailed information or make modifications.

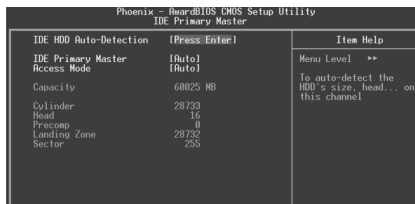

IDE Primary Master Setup Menu

Hard Disk

Primary Master/Primary Slave/Secondary Master/Secondary Slave

These categories identify the HDD types of 2 IDE channels installed in the computer system. There are three choices provided for the Enhanced IDE BIOS: None, Auto, and Manual. 'None' means no HDD is installed or set; 'Auto' means the system can auto-detect the hard disk when booting up; by choosing 'Manual', the related information should be entered regarding the following items. Enter the information directly from the keyboard and press < Enter>:

CYLS	number of cylinders	HEAD	number of heads
PRECOMP	write pre-compensation	LANDZ	landing zone
SECTOR	number of sectors	MODE	HDD access mode



The Award BIOS supports 3 HDD modes: NORMAL, LBA and LARGE, or Auto detect.

CHS mode

Generic access mode in which neither the BIOS nor the IDE controller will make any transformation during accessing. The maximum number of cylinders, heads and sectors for CHS mode are 1024, 16 and 63.

If the user sets his HDD to NORMAL mode, the maximum accessible HDD size will be 528 megabytes even though its physical size may be greater than that.

LBA (Logical Block Addressing) mode

A new HDD accessing method to overcome the 528 Megabyte bottleneck. The number of cylinders, heads and sectors shown in setup may not be the number physically contained in the HDD.

During HDD accessing, the IDE controller will transform the logical address described by sector, head and cylinder number into its own physical address inside the HDD.

Large mode

Some IDE HDDs contain more than 1024 cylinder without LBA support (in some cases, users do not want LBA). The Award BIOS provides another alternative to support these kinds of HDD.

BIOS tricks DOS (or other OS) into dividing the number of cylinders is less than 1024 by dividing it by 2. At the same time, the number of heads is multiplied by 2. A reverse transformation process will be made inside INT13h in order to access the right HDD address.

Auto Detect

If using Auto detect, the BIOS will automatically detect the IDE hard disk mode and set it as one of the three modes.

Remark

To support LBA or LARGE mode of HDDs, there must be some softwares involved which are located in Award HDD Service Routine (INT13h). It may fail to access a HDD with LBA (LARGE) mode selected if you are running under an Operating System which replaces the whole INT 13h.



Video

Set this field to the type of video display card installed in your system.

EGA/ VGA	Enhanced Graphics Adapter / Video Graphic Array. For EGA, VGA, SEGA, SVGA, or PGA monitor adapters.
CGA 40	Color Graphic Adapter, powering up in 40 column mode.
CGA 80	Color Graphic Adapter, powering up in 80 column mode.
MONO	Monochrome adapter, including high resolution monochrome adapters.

Halt On

This category determines whether or not the computer will stop if an error is detected during powering up.

No errors	The system boot will not stop for any errors that may be detected.
All errors	Whenever the BIOS detects a non-fatal error, the system will stop and you will be prompted.
All, But Keyboard	The system boot will not stop for a keyboard error; but it will stop for all other errors.
All, But Diskette	The system boot will not stop for a disk error; but it will stop for all other errors.
All, But Disk/Key	The system boot will not stop for a keyboard or disk error, but it will stop for all other errors.

Memory

This is a Display-Only Category, determined by POST (Power On Self Test) of the BIOS.

Base Memory	The POST of the BIOS will determine the amount of base (or conventional) memory installed in the system.
Extended Memory	The BIOS determines how much extended memory is presented during the POST.
Total Memory	Total memory of the system .





BIOS Features Setup

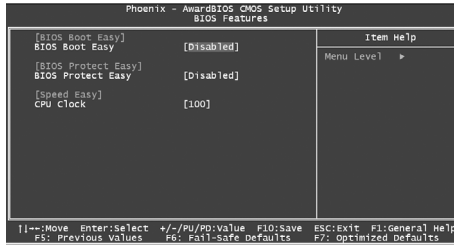

BIOS Features Menu

<u>Item</u>	<u>Option</u>	<u>Description</u>
• Boot Easy	<i>Enabled</i> <i>Disabled</i>	Enable Boot Easy Disable Boot Easy
• BIOS Protect Easy	<i>Enabled</i> <i>Disabled</i>	Enable BIOS Protect Easy Disable BIOS Protect Easy
• CPU Clock	100~232	Set CPU Clock

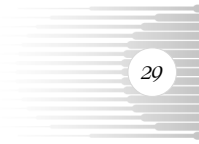

Advanced BIOS Features Setup

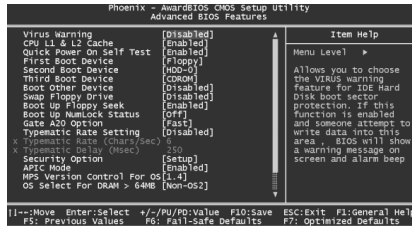

Advanced BIOS Features Menu

The following indicates the options for each item and describes their meaning.

<u>Item</u>	<u>Option</u>	<u>Description</u>
• Virus warning	<i>Enabled</i> <i>Disabled</i>	Allows you to choose the VIRUS warning feature for IDE Hard Disk boot sector protection. If this function is enabled and someone attempt to write data into this area, BIOS will show a warning Message on screen and alarm beep. Invalidates this function.
• CPU L1&L2 Cache	<i>Enabled</i> <i>Disabled</i>	Enable CPU L1/L2 cache. Disable CPU L1/L2 cache.
• Quick Power On Self Test	<i>Enabled</i> <i>Disabled</i>	Allow the system to skip certain tests while booting. This will decrease the time needed to boot the system. Normal POST.
• First(Second, Third)Boot Device	<i>Disabled</i> <i>Floppy/LS120</i> <i>ICDROM</i>	Select your boot device priority. It could be Disable, Floppy, LS/ZIP, HDD-0, HDD-1, HDD-2, HDD-3, SCSI, CDROM, LAN, USB-FDD, USB-ZIP, USB-CDROM, USB-HDD Boot other Device
• Swap Floppy Drive	<i>Enabled</i> <i>Disabled</i>	If the system has two floppy drives, choose enable to assign physical drive B to logical drive A and Vice-versa.



<u>Item</u>	<u>Option</u>	<u>Description</u>
● Boot up Floppy	<i>Enabled</i>	Enabled tests floppy drives to determine Seek Whether they have 40 or 80 tracks.
	<i>Disabled</i>	
● Boot Up NumLock Status	<i>On</i>	Keypad is used as number keys.
	<i>Off</i>	Keypad is used as arrow keys.
● Gate A20 Option	<i>Normal</i>	The A20 signal is controlled by the key board Controller.
	<i>Fast</i>	The A20 signal is controlled by Port92.
● Typematic Rate Setting	<i>Enabled</i>	Keystrokes repeat at a rate determined by the keyboard controller-when enabled, the typematic ate and typematic delay can be selected.
	<i>Disabled</i>	
● Typematic Rate (chars/sec)	6-30	The rate at which character repeats when you hold down a key.
● Typematic Delay (Msec)	250-1000	The delay before keystrokes begin to repeat.
● Security Option	<i>Setup System</i>	Select whether the password is required every time the system boot or only when you enter setup.
● APIC Mode	<i>Disabled</i>	Enable the APIC mode.
	<i>Enabled</i>	Disable the APIC mode.
● MPS Version Control For OS	<i>Disabled</i>	Set the MPS Version Control for OS.
	<i>Enabled</i>	
● OS Select For DRAM>64MB	<i>Non-OS2</i>	Select OS2 only if you are running OS/2 operating system with more than 64MB of RAM.
	<i>OS2</i>	
● Report No FDD for WIN 95	<i>Yes</i>	Report NO Floppy Disk Drive for WIN 95 to release IRQ6.
	<i>NO</i>	Do not report No Floppy Disk Drive for WIN 95.
● Small Logo(EPA) Show	<i>Disabled</i>	The EPA logo will be show when system boot up, otherwise, no logo appears on the screen.
	<i>Enabled</i>	





Advanced Chipset Features Setup

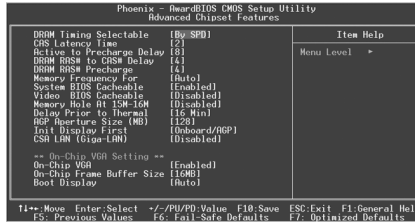

Advanced Chipset Features Setup

The following indicates the options for each item and describes their meaning.

<u>Item</u>	<u>Option</u>	<u>Description</u>
• DRAM Timing Selectable	<i>By User</i> <i>By SPD</i>	DRAM timing is defined by user. DRAM timing is defined by SPD.
• CAS Latency Time	2,2,5,3	Set DRAM CAS latency time.
• Active to Precharge Delay	8,7,6,5	Set DRAM precharge delay time.
• DRAM RAS# to CAS# Delay	4,3,2	Set DRAM RAS# to CAS# delay 4 SCLKs 3 SCLKs or 2 SCLKs.
• DRAM RAS# Precharge	4,3,2	Set DRAM RAS# precharge as 4,3 or 2.
• Memory Frequency For	<i>Auto</i> <i>DDR266</i> <i>DDR333</i> <i>DDR400</i>	Set Memory Frequency. Set Memory Frequency as 266MHz. Set Memory Frequency as 333MHz. Set Memory Frequency as 400MHz (Opt.)
• System BIOS Cacheable	<i>Enabled</i> <i>Disabled</i>	Besides conventional memory, the system BIOS area is also cacheable. System BIOS area is not cacheable.
• Video BIOS Cacheable	<i>Enabled</i> <i>Disabled</i>	Besides conventional memory, video BIOS area is also cacheable Video BIOS area is not cacheable



<u>Item</u>	<u>Option</u>	<u>Description</u>
• Memory hole at 15M-16M	<i>Enabled</i> <i>Disabled</i>	Memory hole at 15-16M is reserved for expanded ISA card. Do not set this memory hole.
• Delay Prior to thermal	<i>4/8/16Min</i> <i>32Min</i>	Setting time for CPU automatically enters thermal mode.
• AGP Aperture Size(MB)	<i>4/8/16/32MB</i> <i>64/128/256MB</i>	Set the effective size of the Graphics Aperture to be used in the particular GART configuration(It is not available when onboard VGA used).
• Init Display First	<i>PCI Slot</i> <i>Onboard/AGP</i>	Initialize PCI slot. Initialize AGP slot.
• CSA LAN (Giga-Lan)	<i>Disabled</i> <i>Enabled</i>	Disable onboard Giga-Lan Enable onboard Giga-Lan

Warning: CSA LAN (Giga-Lan) option only available with onboard Giga-Lan model(-K).

On-chip VGA Setting

• On-chip VGA	<i>Enabled</i> <i>Disabled</i>	Enable onboard VGA Disable onboard VGA(It is not available when external graphics card used).
• On-chip Frame Buffer Size	<i>1,4,8,16,32MB</i>	Set On-chip Frame Buffer as 8MB or 1MB.(It is not available when external graphics card used).
• Boot Display	<i>Auto</i> <i>CRT</i> <i>TV</i> <i>EFP</i>	When use ADD card,the system BOOT display.





Integrated Peripherals



Integrated Peripherals Menu

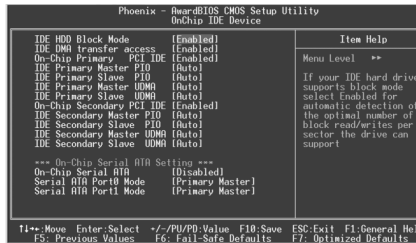

Onchip IDE Menu

The following indicates the options for each item and describes their meaning.

<u>Item</u>	<u>Option</u>	<u>Description</u>
● IDE HDD Block Mode	<i>Enabled</i>	Allow IDE HDD to read/write several once.
	<i>Disabled</i>	IDE HDD only reads/writes a sector once.
● On-Chip Primary PCI IDE	<i>Enabled</i>	On-Chip Primary PCI IDE is enabled.
	<i>Disabled</i>	On-Chip Primary PCI IDE is disabled.
● IDE Primary Master/ Slave PIO/UDMA	<i>Auto</i>	Select IDE primary master/slave PIO/UDMA transfers mode.
	<i>Mode 0~4</i>	
● On-Chip Secondary PCI IDE	<i>Enabled</i>	On-Chip Secondary PCI IDE is enabled.
	<i>Disabled</i>	





Item	Option	Description
● IDE Secondary Master/ Slave PIO/UDMA	<i>Auto</i>	Select IDE secondary master/slave PIO/UDMA transfers mode.
	<i>Mode 0~4</i>	
● On-Chip Serial ATA	<i>Enabled</i> <i>Disabled</i>	On-chip serial ATA is enabled.
● Serial ATA Port 0/1 Mode	<i>Primary-Master/Slave</i>	No Primary master/slave IDE port Support IDE/SATA boot.
	<i>Secondary-Master/Slave</i>	No Secondary master/slave IDE port Support IDE/SATA boot.
	<i>Logical-Primary/Secondary</i>	No Primary/Secondary IDE port Support SATA boot.
	<i>Tertiary-Master/Quaternary-Master</i>	Support Primary/Secondary IDE port Support IDE boot



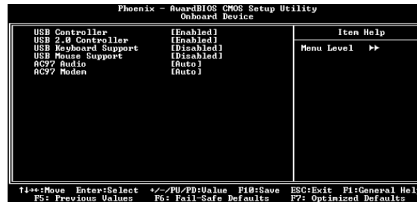

Onboard Configuration Setup Menu

<u>Item</u>	<u>Option</u>	<u>Description</u>
-------------	---------------	--------------------

<ul style="list-style-type: none"> USB Controller 	<p><i>Enabled</i></p> <p><i>Disabled</i></p>	<p>Enable onchip USB controller.</p> <p>Disable onchip USB controller.</p>
<ul style="list-style-type: none"> USB2.0 Controller 	<p><i>Enabled</i></p> <p><i>Disabled</i></p>	<p>Enable onchip USB(2.0) controller.</p> <p>Disable onchip USB(2.0) controller.</p>
<ul style="list-style-type: none"> USB KB/MS Support 	<p><i>Enabled</i></p> <p><i>Disabled</i></p>	<p>Support USB KB/MS under legacy OS.</p> <p>Do not Support USB KB/MS under legacy OS.</p>
<ul style="list-style-type: none"> AC97 Audio 	<p><i>Auto</i></p> <p><i>Disabled</i></p>	<p>If audio codec was installed on board, the AC'97 Audio funtion can be used. Otherwise,the funtion is disabled.</p> <p>Disable the AC'97 Audio on board.</p>
<ul style="list-style-type: none"> AC97 Modem 	<p><i>Auto</i></p> <p><i>Disabled</i></p>	<p>If audio codec was installed on board, the AC'97 Modem funtion can be used. Otherwise,the funtion is disabled.</p> <p>Disable the AC'97 Modem on board.</p>



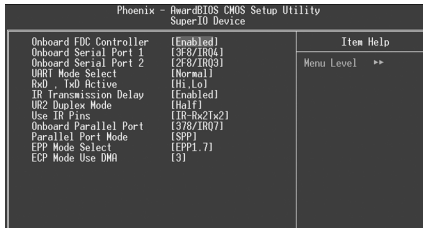

Super IO Configuration Setup Menu

<u>Item</u>	<u>Option</u>	<u>Description</u>
● Onboard FDC Controller	<i>Enabled</i>	Onboard floppy disk controller is enabled.
	<i>Disabled</i>	Onboard floppy disk controller is disabled.
● Onboard Serial Port1/2	<i>Disabled</i>	Onboard serial port is disabled.
	<i>3F8/IRQ4, 2F8/IRQ3, 3E8/IRQ4, 2E8/IRQ3,</i>	Define the onboard serial port address and required interrupt number.
	<i>Auto</i>	Onboard serial port address and IRQ are automatically assigned.
● UART Mode Select	<i>IrDA,ASKIR Normal</i>	Set UART mode.





<u>Item</u>	<u>Option</u>	<u>Description</u>
• RxD,TxD Active	<i>Hi,Hi</i> <i>Hi,Lo</i> <i>Lo,Hi</i> <i>Lo,Lo</i>	Default is recommended.
• IR Transmission Delay	<i>Enabled</i> <i>Disabled</i>	Enable IR Transmission delay funtion. Disable IR Transmission delay funtion.
• UR2 Duplex Mode	<i>Full</i> <i>Half</i>	Default is recommended.
• Use IR Pins	<i>RxD2,TxD2</i> <i>IR-Rx2Tx2</i>	Default is recommended.
• Onboard Parrallel Port	<i>Disabled</i> <i>378/IRQ7,</i> <i>278/IRQ5,</i> <i>3BC/IRQ7</i>	Onboard Parrallel Port is disaled. Define Parrallel Port address and IRQ channel.
• Parrallel Port Mode Mode	<i>SPP,EPP</i> <i>ECP</i> <i>ECP+EPP</i> <i>Normal</i>	Define the Parrallel Port mode.
• EPP Mode Select	<i>EPP 1.7</i> <i>EPP 1.9</i>	Set EPP Mode as EPP 1.7 or EPP 1.9 Version.
• ECP Mode Use DMA	<i>1,3</i>	Set ECP Mode Use DMA 1 or 3.





Power Management Setup

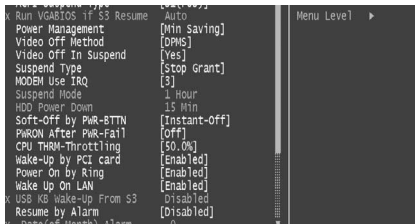

Power Management Setup Menu

The following indicates the options for each item and describes their meaning.

<u>Item</u>	<u>Option</u>	<u>Description</u>
● ACPI function	<i>Enabled</i>	Enable ACPI function. This function is always enabled.
	<i>Disabled</i>	Disable this function.
● ACPI Suspend Type	<i>S1(POS)</i>	Select the ACPI suspend type.
	<i>S3(STR)</i>	
	<i>S1&S3</i>	
● Run VGABIOS	<i>Auto</i>	The VGA device could be initialized automatically if S3 Resume when system was waken up from S3 status.
	<i>Yes</i>	Enable VGA device be initialized when system was waken up from S3 status.
	<i>No</i>	Disable VGA device be initialized when system was waken up from S3 status.
● Power Management	<i>User Define</i>	Users can configure their own Power Management Timer.
	<i>Min Saving</i>	Pre-defined timer values are used. All timers are in their MAX values.
	<i>Max Saving</i>	Pre-defined timer values are used. All timers are in their MIN values.



<u>Item</u>	<u>Option</u>	<u>Description</u>
<ul style="list-style-type: none"> Video Off Method 	<i>Blank Screen</i>	The system BIOS will only blank off the screen when disabling video.
	<i>V/H SYNC +</i>	In addition to Blank Screen, BIOS will also turn Blank off the V-SYNC & H-SYNC signals from VGA card to monitor.
	<i>DPMS</i>	This function is enabled only for VGA cards supporting DPMS. Note: When the green monitor does not detect the V/H-SYNC signals, the electron gun will be turned off.
<ul style="list-style-type: none"> Video Off in Suspend 	<i>Yes</i>	The system will disable video when entering suspend mode.
	<i>No</i>	Do not turn off video when entering suspend mode.
<ul style="list-style-type: none"> Suspend Type 	<i>Stop Grant PwrOn Suspend</i>	Select the Suspend type.
<ul style="list-style-type: none"> Modem Use IRQ 	<i>3,4,5,7,9 10,11</i>	Special Wake-up event for Modem.
	<i>NA</i>	This function is not applied.
<ul style="list-style-type: none"> Suspend Mode 	<i>Disabled 1Min~1Hour</i>	The system never enter suspend mode by timer Define the continuous idle time before the system enters suspend mode.If any items defined in "PM events"are on and activated, the system will be woken up.
<ul style="list-style-type: none"> HDD Power Down 	<i>Disabled 1-15Min</i>	HDD's motor will not be off by timer. Define the continuous HDD idle time before the HDD enters power saving mode(motor off).
<ul style="list-style-type: none"> Soft-off by PWR-BTTN 	<i>Instant-Off</i>	The system will immediately power off once the power button is pressed.
	<i>Delay 4 sec</i>	The system will power off when power button is pressed for 4 seconds.



<u>Item</u>	<u>Option</u>	<u>Description</u>
• CPU THRM- Throttling	12.5%,25%, 50%,37.5%, 62.5%,75%, 87.5%	Select the duty cycle of the STPCLK# signal, slowing down the CPU speed when the system enters green mode.
• Wake-Up by PCI Card	<i>Enabled</i> <i>Disabled</i>	Allow the system to be waked up by PCI card. Do not allow the system to be powered on by PCI card.
• Power on by Ring	<i>Enabled</i> <i>Disabled</i>	Allow the system to be powered on when a ring indicator signal comes up to serial port1 from external modem. Do not allow ring wake up.
• Wake Up ON LAN	<i>Enabled</i> <i>Disabled</i>	Allow the system to be powered on when a LAN indicator signal comes up to LAN wake-up header from LAN adapter. Do not allow LAN wake up.
• USB KB Wake-up from S3	<i>Enabled</i> <i>Disabled</i>	USB device can be used to wake up the system from S3 status. Disable this function.
• Resume by Alarm	<i>Enabled</i> <i>Disabled</i>	RTC alarm can be used to generate a wake-up event to power up the system. RTC has no alarm function.
• Date(of Month) Alarm	<i>Min=0</i> <i>Max=30</i> <i>Keyin a DEC</i> <i>No.</i>	Set Wake-up date.
• Time(hh:mm:ss) Alarm	<i>Min=0</i> <i>Max=23</i> <i>Keyin a DEC</i> <i>No.</i>	Set Wake-up time.





<u>Item</u>	<u>Option</u>	<u>Description</u>
● Primary IDE 0/1, Secondary IDE 0/1	<i>Enabled</i>	Reload global timer,when there's an IDE event.
	<i>Disabled</i>	Do not reload global timer.
● FDD/COM/LPT FDD/Port	<i>Enabled</i>	Reload global timer,when there's a COM/LPT event.
	<i>Disabled</i>	Do not reload global timer.
● PCI PIRQ(A-D)#	<i>Enabled</i>	Reload global timer,when there's a PCI event.
	<i>Disabled</i>	Do not reload global timer.
● Power On Function	<i>Password, Hot-key, Ms L/R Any key, Button Only, KB 98</i>	Power on by power button. Power on with keyboard password.
● KB Power On Password	<i>Enter</i>	Enter keyboard password.
● Hot Key Power On	<i>Ctrl F1-F12</i>	Ctrl-F1 default(internal selectiveF1-F12).
● PWRON After PWR-Fail	<i>Off, On, Former Sts</i>	The system remains OFF/ON/ Former state when the AC power supply resumes.





PNP/PCI Configuration Setup

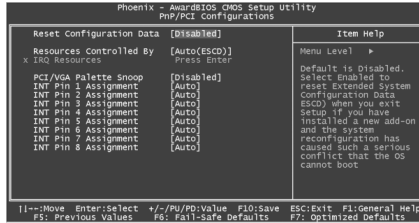

PNP/PCI Configuration Setup Menu

The following indicates the options for each item and describes their meaning.

<u>Item</u>	<u>Option</u>	<u>Description</u>
● Reset Configuration Data	<i>Enabled</i>	Default setting is Disabled. Select Enabled to reset Extended System Configuration Data ESCD when you exit Setup, if you have installed a new add-on and the system reconfiguration has caused serious conflicts preventing the OS from booting.
	<i>Disabled</i>	Disable the configuration data function.
● Resources Controlled By	<i>Auto(ESCD)</i>	BIOS can automatically configure all boot and Plug and Play compatible devices. If you choose Auto, you cannot select IRQ DMA and memory base address fields, because BIOS automatically assigns them.
	<i>Manual</i>	
● IRQ Resource	<i>Press Enter</i>	IRQ Resources are determined by user.
● PCI/VGA Palette Snoop	<i>Disabled</i>	Default setting.
	<i>Enabled</i>	Non-standard VGA cards such as graphics accelerators or MPEG video cards may not show colors properly. Enabling this item can solve this problem.
● INT Pin 1-8 Assignment	<i>3,4,5,7,9,10</i>	Assignment PCI device IRQ.
	<i>11,12,14,15</i>	
	<i>Auto</i>	





PC Health Status

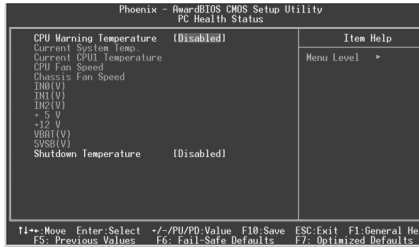

PC Health Status Menu

The following indicates the options for each item and describes their meaning.

Item	Option	Description
------	--------	-------------

44

- | | | |
|--|--|--|
| <ul style="list-style-type: none"> • CPU Warning Temperature | <p>60°C/140°F
65°C/149°F
70°C/158°F
75°C/167°F</p> | <p>The system will warning when the CPU temperature reaches the previous setting.</p> |
| <ul style="list-style-type: none"> • Shutdown Temperature | | <p>The system will shut down automatically under the ACPI OS when the CPU temperature reaches the previous setting.</p> |
| <ul style="list-style-type: none"> • Current System Temperature | | <p>The temperature inside the chassis.</p> |
| <ul style="list-style-type: none"> • Current CPU Temperature | | <p>The temperature of CPU.</p> |
| <ul style="list-style-type: none"> • CPU Vcore
+3.3V
+5V
+12V | | <p>Display current voltage value including all significant voltages of the mainboard.+3.3V,+5V,+12V, are voltages from the power supply.</p> |
| <ul style="list-style-type: none"> • CPU FAN Speed | | <p>CPU FAN Speed.</p> |
| <ul style="list-style-type: none"> • Chassis FAN Speed | | <p>Chassis FAN Speed.</p> |





<u>Item</u>	<u>Option</u>	<u>Description</u>
• Waning-Beep		The system will warning when the CPU temperature reaches the previous setting.
• System FAN Speed		System FAN Speed.
• Back FAN Speed		Back FAN Speed.



Frequency/Voltage Control

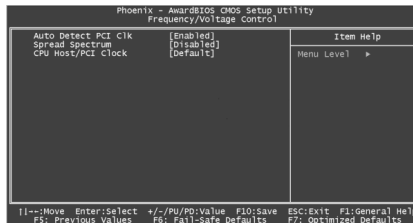

Frequency/Voltage Control

The following indicates the options for each item and describes their meaning.

Item	Option	Description
<ul style="list-style-type: none"> Auto Detect PCI Clk 	<p><i>Enabled</i> <i>Disabled</i></p>	<p>Close empty PCI clock to reduce EMI. Do not close empty PCI clock.</p>
<ul style="list-style-type: none"> Spread Spectrum 	<p>$\pm 0.25\%$ -0.5% $\pm 0.5\%$ $\pm 0.38\%$ <i>Disabled</i></p>	<p>Issus the spectrum range is $\pm 0.25\%$. Issus the spectrum range is -0.5%. Issus the spectrum range is $\pm 0.5\%$. Issus the spectrum range is $\pm 0.38\%$. Disabled this funtion.</p>
<ul style="list-style-type: none"> CPU Host/PCI Clock 	<p><i>Default</i> <i>133/33MHz</i> ... <i>164/41MHz</i></p>	<p>Set CPU/PCI clock as default. Set CPU/PCI clock.</p>

Warning:

Be sure your selection is right. CPU over speed will be dangerous! We will not be responsible for any damages caused.



Password Setting

When this function is selected, the following message appears at the center of the screen to assist you in creating a password.

Set User PASSWORD & Supervisor Password

Type the password, up to eight characters, and press <Enter>. The password typed now will clear any previously entered password from CMOS memory. You will be asked to confirm the password. Type the password again and press <Enter>. You may also press <Esc> to abort the selection.

To disable password, just press <Enter> when you are prompted to enter password. A message will confirm the password being disabled. Once the password is disabled, the system will boot and you can enter BIOS Setup freely.

Password Disabled

If you have selected "**System**" in "Security Option" of "Advanced BIOS Features Setup" menu, you will be prompted for the password every time the system reboots or any time you try to enter BIOS Setup.

If you have selected "**Setup**" at "Security Option" from "Advanced BIOS Features Setup" menu, you will be prompted for the password only when you enter BIOS Setup.

Supervisor Password has higher priority than User Password. You can use Supervisor Password when booting the system or entering BIOS Setup to modify all settings. Also you can use User Password when booting the system or entering BIOS Setup but can not modify any setting if Supervisor Password is enabled.

Boot with BIOS defaults

If you have made all the changes to CMOS values and the system can not boot with the CMOS values selected in setup, you could remove the power, and use the clear CMOS jumper to clear CMOS. Then when insert the power, the computer will auto power on with BIOS default settings.



Appendix

QDI Utility CD

A QDI Utility CD is supplied with this mainboard, the contents contained in it are showed as below:

1. Driver Install

Using this choice, you can install all the drivers for your main board. You should install the drivers in order, and you need to restart your computer until all the drivers are installed.

- | | |
|---------------------|-----------------|
| A. Chipset software | B. IAA Setup |
| C. USB2.0 Driver | D. VGA Driver |
| E. Network Driver | F. Audio Driver |
| G. DirectX | |

2. Accessory

- A. Norton AntiVirus 2003

48

3. Browse CD

You could read all the contents contained in this CD, including Utility.

The files included in Utility are:

- | | |
|-----------------|-------------------|
| A. Awdflash.exe | B. Pro-StepEasy |
| C. Pro-LogoEasy | D. Pro-UpdateEasy |

Norton AntiVirus

When you install Norton AntiVirus and accept options, your computer is safe. Norton AntiVirus automatically checks boot records for viruses at system startup, checks programs for viruses at the time you use them, scans all local hard drives for viruses once per week, and monitors your computer for any activity that might indicate the work of a virus in action. It also scans files you download from the Internet and checks floppy disks for boot viruses when you use them. The list below shows the most important tasks Norton AntiVirus helps you perform: Scan for viruses on your computer; Remove viruses from your computer; Update your virus protection with LiveUpdate; Quarantine an infected file. You can go to the Symantec Web site to view an online tutorial:
<http://www.symantec.com/techsupp/tutorial>



SpeedEasy



SpeedEasy is a powerful and efficient Easy Technology for PC DIY fans. It provides a friendly interface. The users can also realize in the BIOS setup the CPU core voltage adjustability.

Procedures:

1. Correctly insert your CPU.
2. Plug in other configurations and restore the system.
3. Switch on power to the system and press the key to enter BIOS Setup.
4. Enter <BOS Features> menu to set up the CPU speed.
5. Save and exit BIOS Setup, your system will now boot successfully.

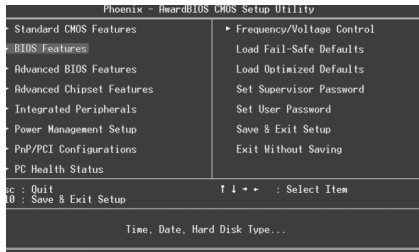

BIOS provides you with a set of basic values for your processor selection instead of the jumper settings. The processor speed can be manually selected on the <BIOS Features> menu screen.

Warning: Do not set CPU frequency higher than its working frequency. If you do, we will not be responsible for any damages caused.



Pro-LogoEasy

Pro-LogoEasy is a Windows utility that allows user to change sign on logo of BIOS. The utility will be able to replace logo of BIOS and backup, update BIOS image within Windows environment.

The Pro-LogoEasy features:

1. No special HW design in MB.
2. Support Win2000 and WinXP.
3. Support 2MB and 4MB size of flash parts, flash write method is independent with flash type.
4. With friendly graphics user interface, it is simple and easy to operate.
5. Support BMP, Jpeg graphic format files with 16 or 256 colors, 640x480 or 800x600 resolution.

50

Using the Pro-LogoEasy:

Switch to ROM
Info page

Display the Flash
Information

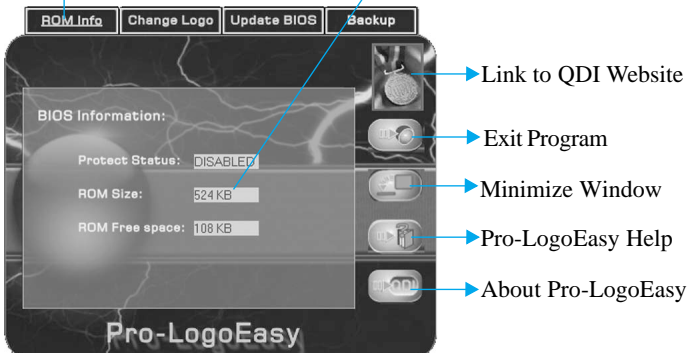

Switch to Change Logo page

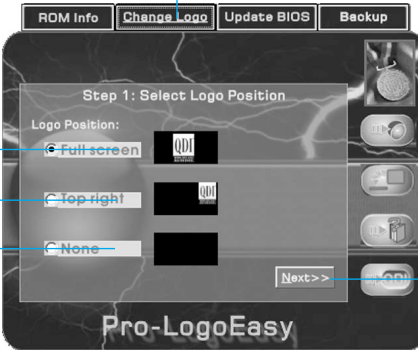

The screenshot shows the 'Change Logo' page in Pro-LogoEasy. At the top, there are four tabs: 'ROM Info', 'Change Logo', 'Update BIOS', and 'Backup'. The 'Change Logo' tab is active. The main area displays 'Step 1: Select Logo Position' with three radio button options: 'Full-screen', 'Top-right', and 'None'. The 'Full-screen' option is selected. Below the options is a 'Next>>' button. On the right side, there is a vertical toolbar with several icons. A blue arrow points from the 'Full-screen' option to the text 'Full screen mode'. Another blue arrow points from the 'Top-right' option to 'Top-Right mode'. A third blue arrow points from the 'None' option to 'Boot without logo'. A fourth blue arrow points from the 'Next>>' button to 'Follow the Wizard to complete the logo update'. The 'Pro-LogoEasy' logo is at the bottom.

Switch to Update BIOS page



The screenshot shows the 'Update BIOS' page in Pro-LogoEasy. At the top, there are four tabs: 'ROM Info', 'Change Logo', 'Update BIOS', and 'Backup'. The 'Update BIOS' tab is active. The main area displays 'Step 1: Select a BIN File' with a 'BIN File:' label and a text input field. To the right of the input field is a 'Browse...' button. Below the input field is a 'Next>>' button. On the right side, there is a vertical toolbar with several icons. A blue arrow points from the 'Browse...' button to the text 'Browse a bin image file for updating'. Another blue arrow points from the 'Next>>' button to 'Follow the Wizard to complete the BIOS function'. The 'Pro-LogoEasy' logo is at the bottom.

Switch to Backup page



The screenshot shows the 'Backup' page in Pro-LogoEasy. At the top, there are four tabs: 'ROM Info', 'Change Logo', 'Update BIOS', and 'Backup'. The 'Backup' tab is active. The main area displays 'Select Backup Object:' with two radio button options: 'BIOS' and 'Logo'. The 'Logo' option is selected. Below the options is a 'Next>>' button. On the right side, there is a vertical toolbar with several icons. A blue arrow points from the 'Logo' option to the text 'Browse a bin image file fro flash'. Another blue arrow points from the 'Next>>' button to 'Follow the Wizard to complete the Flash function'. The 'Pro-LogoEasy' logo is at the bottom.



Pro-StepEasy

Pro-StepEasy is a utility that allows user to change the frequency of CPU. It also display system health which including CPU temperature, CPU voltage, and PCI/ AGP clock.

The Pro-StepEasy features:

1. Support Win2000 and WinXP.
2. Automatic alarm mechanism when system runs irregularly
3. Adjust the CPU frequency to speed up your system and get better system performance.
4. With friendly graphics user interface, it is simple and easy to operate.

Using the Pro-StepEasy:

The screenshot shows the Pro-StepEasy utility window with the following components and labels:

- Switch to FAN related page**: Points to the 'FAN' tab at the top left.
- The speed of CPU Fan**: Points to the CPU fan speed control knob.
- Adjust the warning criteria of CPU FAN**: Points to the 'CPU (RPM)' input field in the 'Low Limit Setting' section.
- Adjust the warning criteria of system FAN1**: Points to the 'SYS1 (RPM)' input field.
- Reset the warning criteria to default**: Points to the 'Default' button.
- Apply the adjustments**: Points to the 'Apply' button.
- The speed of System Fan1**: Points to the SYS1 fan speed control knob.
- The speed of System Fan2**: Points to the SYS2 fan speed control knob.
- Adjust the warning criteria of system FAN2**: Points to the 'SYS2 (RPM)' input field.
- Link to QDI Website**: Points to the top-most button in the right sidebar.
- Exit Program**: Points to the second button in the right sidebar.
- Minimize Window**: Points to the third button in the right sidebar.
- Pro-StepEasy Help**: Points to the fourth button in the right sidebar.
- About Pro-StepEasy**: Points to the fifth button in the right sidebar.



Switch to Voltage related page

Adjust the warning criteria of voltages (High part)

The read voltages

Value(V)	High(V)	Low(V)
VCoreA: 1.40	1.776	1.2
VCoreB: 1.48	1.776	1.2
+3.3V: 3.32	3.936	2.64
+5V: 5.02	5.967	3.951
+12V: 12.09	13.072	10.7
-12V: -11.95	-10.8	-13.264
-5V: -	0	-
5VSB: 4.94	5.963	4
VBAT: 3.21	3.936	2.64

Reset the warning criteria to default settings

Apply the adjustments

Adjust the warning criteria of voltages (Low part)

Switch to Clock related page

Current CPU Frequency

Adjust the CPU Ratio

Current AGP clock

Current PCI clock

Adjust the Ext. CPU Freq.

Reset the warning criteria to default settings

Apply the adjustments



Switch to Temperature related page

Current CPU Temperature

Current system Temperature

Adjust the warning criteria of high CPU temperature

Adjust the warning criteria of high system temperature

Reset the warning criteria to default settings

Apply the adjustments

Switch to Warning related page

Check for system pops up warning message automatically

Reset to the default settings

Apply the changes settings



Pro-UpdateEasy



Pro-UpdateEasy is a Windows utility that allowed user to backup and upgrade the system BIOS, from local or via internet.

The Pro-UpdateEasy features:

1. No special HW design in MB.
2. Support Win2000 and WinXP.
3. Support 2MB and 4MB size of flash parts, flash write method is independent with flash type.
4. Program checks and compares the MB's model ID automatically, then download proper BIOS from web site for update.
5. With friendly graphics user interface, it is simple and easy to operate.

Using the Pro-UpdateEasy:

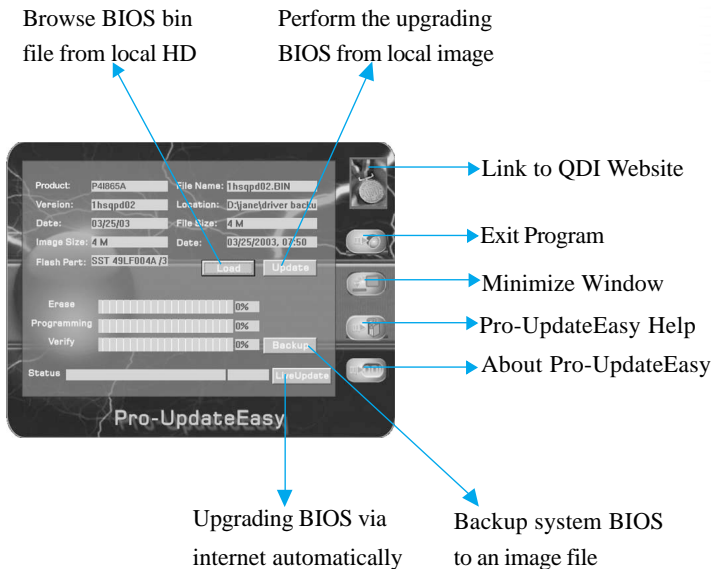

BootEasy



BootEasy technology enormously improves the long BOOT process time of computers. Reducing the wait time every user has to suffer when starting their computer. BIOS without BootEasy has to perform many routines every time when the system starts, such as checking system core of the computer and initializing system peripherals. Now with the BootEasy, BIOS will not run these repetitive Processes any longer, PC can boot-up without any redundant waiting for the displaying of starting OS. BootEasy is quite easy to use, choose the right option in CMOS SETUP, (refer to QDI Innovation features) it can be easily booted quickly. BootEasy save all the information when PC first normally boot-up, and it restores all the parameters for the system and thus let the PC boot freely and rapidly.

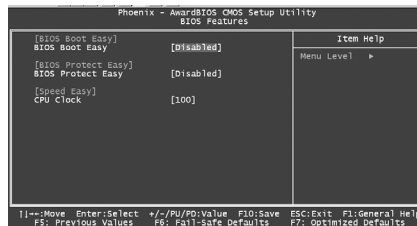
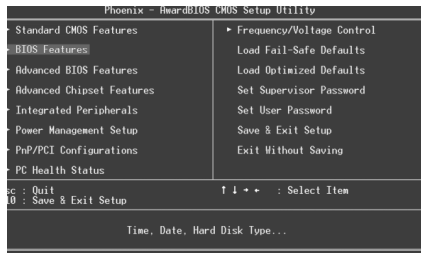

Note:

1. If the previous boot was not completed then BIOS will perform normal POST even the BootEasy was enabled.
2. No matter BootEasy is enabled or not, The BIOS will perform normal POST when CMOS fail.



BIOS-ProtectEasy



The BIOS of the mainboard is contained inside the Flash ROM. Severe viruses such as CIH virus are so dangerous that it may overwrite the BIOS of the mainboard. If the BIOS has been damaged, the system will be unable to boot. We provide the following solution which protects the system BIOS from being attacked by such viruses.

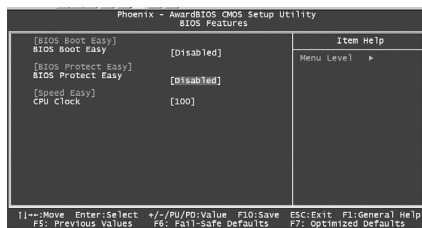
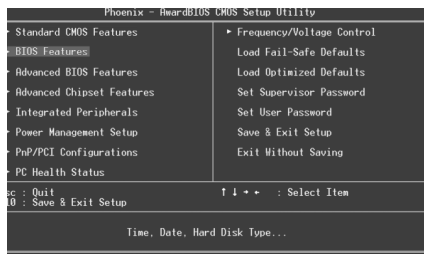

There are two choices which implements this function.

1. Set the jumper (JP2) as closed, the BIOS can not be overwritten.
2. Set the jumper (JP2) as opened, meanwhile set Flash Write Protect as Enabled in CMOS Setup. In this way, the BIOS can not be overwritten, but the DMI information can be updated.
3. JP2 Default is opened.



QDI BootEasy(German)

BootEasy ist eine Neuentwicklung von Legend QDI, die neue Innovation der QDI Easy – Technologien.



BootEasy Setup Menu

58

Mit der BootEasy- Technologie Technik wird der Bootvorgang nur noch vier bis fünf Sekunden in Anspruch nehmen, bis das Betriebssystem geladen wird. Der Grund für die lange Wartezeit liegt in den Routine-Abfragen, die das BIOS bei jedem Start abarbeitet. So wird beispielsweise jedes Mal die Taktfrequenz des Prozessors geprüft oder angeschlossene Geräte aktiviert.

Die BootEasy-Technik prüft diese Punkte nur beim erstmaligen Start des Rechners und speichert die Ergebnisse in einem Flash ROM. Beim nächsten Start ruft das System lediglich diese Informationen aus dem Speicher ab und kann so innerhalb von wenigen Sekunden den Boot-Prozess abschließen.

Bei Änderungen am System, beispielsweise nach dem Einbau eines neuen Prozessors, muss deshalb zuvor die BootEasy-Funktion deaktiviert werden, beim nächsten Start werden die neuen Informationen dann erneut abgespeichert.

Falls Fehler im Flash ROM den Bootvorgang behindern, versucht das System drei Mal den Rechner hochzufahren, bei Misserfolg schaltet es auf die althergebrachte Art zu booten um, das heißt, es dauert wieder ebenso lang wie früher. Anschließend kann die BootEasy – Technik wieder aktiviert werden.

Falls Fehler im Flash ROM den Bootvorgang behindern, versucht das System drei Mal den Rechner hochzufahren, bei Misserfolg schaltet es auf die althergebrachte Art zu booten um, das heißt, es dauert wieder ebenso lang wie früher. Anschließend kann die BootEasy – Technik wieder aktiviert werden.



Instalación de la placa base Legend-QDI P4I865G/P/PEA (Spanish):

1. Asegúrese que se incluyen los siguientes artículos: Placa base Legend-QDI P4I865G/P/PEA , 1 cable de datos para el puerto IDE y 1 cable de datos para el Floppy, jumpers, 1 manual de usuario Legend-QDI P4I865G/P/PEA 2E V2.0y un disco compacto con los controladores de la placa base P4I865G/P/PEA .
2. Asegúrese de que el cable de la fuente de alimentación esta desconectado y asegúrese de estar en contacto a masa utilizando una pulsera antiestática. Si no dispone de dicha pulsera, toque un objeto directamente conectado a masa o una parte metálica de su equipo como puede ser la caja de este.
3. Fije la placa base en la caja de su equipo con los tornillos especiales que acompañan a su caja.
4. Los jumpers están localizados en la placa base, con ellos se configuran, por ejemplo: Clear CMOS JCC, Habilitar BIOS ProtectEasy JAV etc..., el PIN1 para todos los jumpers esta marcado con una línea más gruesa (Consulte el apartado “Jumper Settings” en el manual de usuario de su placa Legend-QDI P4I865G/P/PEA en el capítulo 2).
5. Inserte el procesador en el socket y conecte el ventilador del procesador en el conector de su placa base Legend-QDI P4I865G/P/PEA marcado como “CPUFAN”.
6. Inserte los módulos de memoria en los bancos de memoria DIMM de su placa base Legend-QDI P4I865G/P/PEA .
7. Inserte las tarjetas PCI y/o la tarjeta CNR y AGP en las bahías de expansión de su placa base Legend-QDI P4I865G/P/PEA .
8. Conecte los periféricos internos IDE y las disqueteras mediante los cables de datos específicos a su placa base Legend-QDI P4I865G/P/PEA . Asegúrese que la orientación de los cables sea la correcta. (El cable rojo se corresponde con el pin 1).
9. Conecte los cables de la caja del ordenador a su placa base Legend-QDI P4I865G/P/PEA , como el conector de la fuente de alimentación, los testigos de corriente, y lectura de disco duro, interruptores de inicio y reset (consulte el apartado “External Connectors” del manual de usuario de su placa base Legend-QDI P4I865G/P/PEA).



10. Conecte los diferentes periféricos externos como el teclado PS/2, ratón PS/2, serie o USB, los dispositivos USB, el monitor y la impresora a la placa base Legend-QDI P4I865G/P/PEA (consulte el apartado "External Connectors" en el manual de su placa base Legend-QDI P4I865G/P/PEA, en el capítulo 2).
11. Cuando haya finalizado de realizar todas las conexiones, conecte el cable de alimentación a la fuente de alimentación y encienda su PC:

Instalación del sistema:

1. Encienda su equipo mediante el interruptor de encendido de la caja.
2. Presione la tecla « Supr » para entrar en el menú de configuración de la BIOS.
3. Seleccione los valores de la Bios en concordancia con la configuración de su sistema (Nosotros le recomendamos que deje los valores establecidos por la Bios por defecto, para evitar posibles fallos que ocasionen que su sistema no funcione correctamente). Para más información las funciones de la Bios, consulte el apartado "BIOS Description" en el manual de usuario de la placa base Legend-QDI P4I865G/P/PEA). Presione la tecla « F10 » y seleccione la opción "Save & Exit Setup" en el menú de configuración de la Bios para guardar los cambios y reiniciar el sistema.
4. Instale el sistema operativo en el disco duro, no se olvide de seleccionar la secuencia de inicio correcta para que el sistema operativo pueda iniciarse.
5. Después de la instalación del sistema operativo, asegúrese que no hay conflictos con ningún dispositivo de su sistema.
6. Entonces, después del último paso, proceda a la instalación de los controladores de los diferentes dispositivos.

Un disco compacto con controladores de Legend-QDI esta incluido en el paquete de la placa base Legend-QDI P4I865G/P/PEA.

1. Instalación de los controladores

Usted puede instalar todos los controladores para su placa base fácilmente. Tiene que instalar los controladores en el siguiente orden para un correcto funcionamiento del sistema, y es necesario reiniciar el equipo antes de finalizar la instalación de los controladores.



- A. Chipset software
- C. USB2.0 Driver
- E. Network Driver
- G. DirectX

- B. IAA Setup
- D. VGA Driver
- F. Audio Driver

2. Accesorios

Norton AntiVirus 2003

3. Navegue por el CD

Usted puede leer todos los documentos incluidos en este CD, incluidos Utility and Documents.

Los ficheros incluidos en **Utility** son:

- A. Awdflash.exe
- C. Pro-LogoEasy
- B. Pro-StepEasy
- D. Pro-UpdateEasy



Manuel d'installation des cartes mères de la série Legend-QDI P4I865G/P/PEA (French):

Intégration du système :

1. Vérifier la présence de chaque élément dans la boîte de la carte mère de la série Legend-QDI P4I865G/P/PEA :
 - Une carte mère de la série Legend-QDI P4I865G/P/PEA.
 - Un CD-ROM d'installation Legend-QDI.
 - Un manuel d'utilisation de la carte mère Legend-QDI P4I865G/P/PEA.
 - Un sachet de cavaliers.
 - Une nappe IDE compatible avec la norme ATA/66 destinée au lecteur de disque dur.
 - Une nappe destinée au lecteur de disquette.
 - Un fond de panier métallique destiné à l'unité centrale de l'ordinateur (Caractéristique technique optionnelle).
 - Un câble d'extension destiné à permettre l'exploitation des ports USB 3 et USB 4 ou USB 5 et USB 6 (Caractéristique technique optionnelle).
2. Vérifier que le câble électrique relié au boîtier d'alimentation de l'unité centrale de l'ordinateur est déconnecté. Se relier à la terre grâce à un bracelet lié au poignet. A défaut de disposer d'un bracelet, maintenir un contact physique avec un objet lui-même relié à la terre, ou à une partie métallique du système comme la structure de l'unité centrale de l'ordinateur.
3. Fixer la carte mère dans l'unité centrale de l'ordinateur grâce aux vis fournies avec cette dernière lors de son achat.
4. S'assurer que la carte mère de la série Legend-QDI P4I865G/P/PEA est matériellement correctement configurée, pour cela vérifier que les cavaliers insérés sur les broches intégrées de cette dernière sont correctement positionnés. Dans ce but il est important de se référer à la section nommée « Configuration des cavaliers » du chapitre numéro 2 nommé « Instructions d'installation » contenu dans le manuel d'utilisation livré avec la carte mère de la série Legend-QDI P4I865G/P/PEA lors de son achat.



5. Connecter le processeur dans le socket intégré à la carte mère de la série Legend-QDI P4I865G/P/PEA et prévus à cet effet. Fixer le système de refroidissement de ce dernier et connecter son ventilateur sur les broches nommées « CPUFAN » intégrées à la carte mère de la série Legend-QDI P4I865G/P/PEA et prévus à cet effet.
6. Connecter les éventuelles barrettes de mémoire dans les slots intégrés à la carte mère de la série Legend-QDI P4I865G/P/PEA et prévus à cet effet.
7. Connecter les éventuelles cartes d'extension au format AGP, CNR ou PCI dans les slots intégrés à la carte mère de la série Legend-QDI P4I865G/P/PEA et prévus à cet effet
8. Connecter les éventuels périphériques IDE ainsi que le lecteur de disquette à la carte mère de la série Legend-QDI P4I865G/P/PEA grâce aux nappes fournies avec cette dernière lors de son achat. S'assurer que l'orientation des nappes connectées est correcte en vérifiant que le liseré rouge de ces dernières correspond à l'emplacement de la broche numéro 1 du connecteur.
9. Connecter les câbles de l'unité centrale de l'ordinateur sur les broches intégrées à la carte mère de la série Legend-QDI P4I865G/P/PEA et prévues à cet effet. Dans ce but il est important de se référer à la section nommée « Connecteurs externes » du chapitre numéro 2 nommé « Instructions d'installation » contenu dans le manuel d'utilisation livré avec la carte mère de la série Legend-QDI P4I865G/P/PEA lors de son achat.
10. Raccorder les périphériques externes sur les connecteurs de fond de panier intégrés à la carte mère de la série Legend-QDI P4I865G/P/PEA. Dans ce but il est important de se référer à la section nommée « Connecteurs externes » du chapitre numéro 2 nommé « Instructions d'installation » contenu dans le manuel d'utilisation livré avec la carte mère de la série Legend-QDI P4I865G/P/PEA lors de son achat.
11. Lorsque tous les éléments du système sont correctement intégrés, il est possible de reconnecter le câble électrique au boîtier d'alimentation de l'unité centrale de l'ordinateur.



Installation du système :

1. Démarrer le système en pressant l'interrupteur de fonctionnement de l'unité centrale de l'ordinateur.
2. Presser la touche "Suppr" du clavier afin d'entrer dans le menu de BIOS.
3. Dans le menu de BIOS nommé "QDI Innovation features", ajuster la fréquence de fonctionnement du processeur. Attention, il est fortement recommandé de charger les réglages de sûreté par défaut afin d'éviter un éventuel dysfonctionnement du système. Dans ce but il est important de se référer à la section nommée « Description du BIOS Award » du chapitre numéro 3 nommé « Description du BIOS » contenu dans le manuel d'utilisation livré avec la carte mère de la série Legend-QDI P4I865G/P/PEA lors de son achat.
4. Procéder à l'installation du système d'exploitation sur le lecteur de disque dur intégré au système. Dans ce but il est important de vérifier que la séquence de démarrage du système paramétrable à partir du menu de BIOS permet à la procédure d'installation du système d'exploitation de s'initialiser.
5. Une fois l'installation du système d'exploitation achevée, vérifier qu'il ne subsiste aucun conflit ou périphérique inconnu au sein du système.
6. Après cette étape, procéder à l'installation des pilotes de chaque périphérique détecté par la carte mère de la série Legend-QDI P4I865G/P/PEA.

64

Lors de son achat un CD-ROM d'installation Legend-QDI est livré avec la carte mère de la série Legend-QDI P4I865G/P/PEA.

1. Driver Install :

Avec cette option, il est possible d'installer les pilotes de la carte mère de la série Legend-QDI P4I865G/P/PEA aisément. Il est important d'installer les pilotes en respectant l'ordre prédéfini et de redémarrer le système après avoir effectué l'installation de tous les pilotes.

Applications contenues dans le dossier :



- A. Chipset software
- C. USB2.0 Driver
- E. Network Driver
- G. DirectX

- B. IAA Setup
- D. VGA Driver
- F. Audio Driver

2. Accessory :

Applications contenues dans le dossier :

Norton AntiVirus 2003

3. Browse CD :

Avec cette option, il est possible de consulter l'ensemble des données contenues sur le CD-ROM d'installation Legend-QDI

Applications contenues dans le dossier :

- A. Awdflash.exe
- C. Pro-LogoEasy

- B. Pro-StepEasy
- D. Pro-UpdateEasy



Legend-Qdi P4I865G/P/PEA installazione mainboard **(Italian):**

1. Assicurarasi che la scatola sia completa: Legend-qdi P4I865G/P/PEA mainboard, cavo IDE e Floppy, jumpers, manuale dell'utente della mainboard Legend-QDI P4I865G/P/PEA e cd-rom drivers.
2. Controllare che il cavo alimentazione proveniente dal computer-case sia sconnesso assicurarsi inoltre di aver indossato correttamente il bracciale da polso collegato a massa. In mancanza di questo toccare un punto a massa o una parte metallica del case
3. Fissare la mainboard nel case con le speciali viti fornite con il computer-case
4. I jumper locati sulla mainboard rappresentano: JCC azzeratore BIOS , JAV abilitatore/disabilitatore in BIOS della funzione **protectEasy**; per tutti i jumper il PIN 1 e' contrassegnato da un spessa linea bianca (consultare il manuale al capitolo 2 " JUMPER AND SETTINGS")
5. Inserire il processore nell'apposito slot ; la ventola del processore deve essere collegato nello speciale connettore targato " CPUFAN ".
6. Inserire il modulo/i di memoria nell'apposito memory slots
7. Inserire le periferiche Pci negli appositi Pci slots
8. Collegare le periferiche IDE e il FLOPPY con l'apposito cavo fornito con la mainboard negli specifici connettori marcati. Assicurarasi che l'orientamento del cavo sia corretto. (La linea rossa sul cavo deve essere inserita nell'apposito connettore in corrispondenza del pin 1)
9. Connettere la mainboard con: il cavo di alimentazione proveniente dall'alimentatore, il connettore dell'interruttore di stand by, il connettore del led di segnalazione "acceso", il connettore led di funzionalita' HARD DISK, il connettore dello speaker interno al CASE.....(consultare il manuale capitolo 2. " EXTERNAL CONNECTORS ". Dopo chiudere il CASE)
10. Connettere le differenti periferiche esterne come il PS/2 mouse, la PS/2 tastiera, le prese USB, il monitor e la stampante con gli specifici connettori posizionati sulla faccia esterna della mainboard.
11. Quando la vostra configurazione sara' tutta connessa, aggangiare il cavo di alimentazione



Installazione di sistema

1. Portare in posizione di accesso l'interuttore di ACCESO
2. Usare il tasto DEL per entrare nel software di configurazione del BIOS
3. Regolare le funzioni del BIOS in accordo con la configurazione di sistema (Noi ti raccomandiamo di usare l'impostazione di default per evitare rischi di anomalie di funzionalità). Per maggiori informazioni controllare il capitolo 3, sezione "BIOS DESCRIPTION". Premere F10 sulla tastiera o scegliere "SAVE and EXIT" dal menu di BIOS per salvare le impostazioni scelte ed uscire dal BIOS program.
4. Installare il sistema operativo, non dimenticando di mettere nelle giuste condizioni di partenza la sequenza di boot.
5. Dopo una giusta installazione accertarsi che non vi siano conflitti tra le periferiche in uso
6. Dopo questo ultimo passo procedere all'installazione dei driver delle varie periferiche

IL CD CONTENENTE I DRIVER DELLA VOSTRA MAINBOARD LEGEND-QDI E' CONTENUTO NELLA SCATOLA

1. Installazione driver

E' possibile installare tutti i driver della Vs. mainboard in modo facile e veloce. Dovreste installare i driver nella seguente successione, finito cio' bisogna far ripartire il personal computer.

- | | |
|---------------------|-----------------|
| A. Chipset software | B. IAA Setup |
| C. USB2.0 Driver | D. VGA Driver |
| E. Network Driver | F. Audio Driver |
| G. DirectX | |



Norton AntiVirus 2003

Guardando il CD

Questo manuale di installazione è disponibile anche nella sua versione elettronica all'interno del cd accompagnativo, insieme anche diverse utili quali:

- A. Awdflash.exe
- B. Pro-StepEasy
- C. Pro-LogoEasy
- D. Pro-UpdateEasy



Using 4/6-Channel Audio

The motherboard is equipped with Realtek ALC650 chip, which provides support for 6-channel audio output, including 2 Front, 2 Rear, 1 Center and 1 Subwoofer channel. ALC650 allows the board to attach 4 or 6 speakers for better surround sound effect. The section will tell you how to install and use 4/6-channel audio function on the board.

Installing the Audio Driver

You need to install the driver for Realtek ALC650 chip to function properly before you can get access to 4-/6-channel audio operations. Follow the procedures described below to install the drivers for different operating systems.

Installation for Windows 98SE/ME/2000/XP

The following illustrations are based on Windows ® XP environment and could look slightly different if you install the drivers in different operating systems.

1. Insert the companion CD into the CD-ROM drive. The setup screen will automatically appear.
2. Select the Sound Driver.
3. Click **Next** to start installing files into the system.

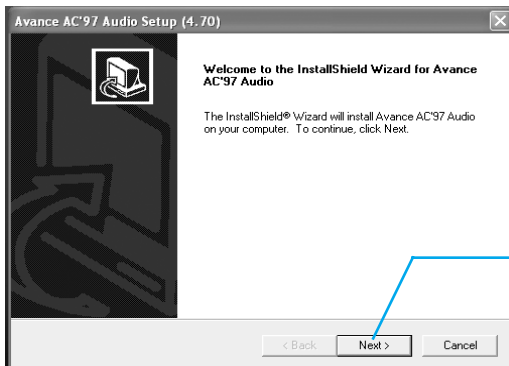

click here



4. Click **Finish** to restart the system.

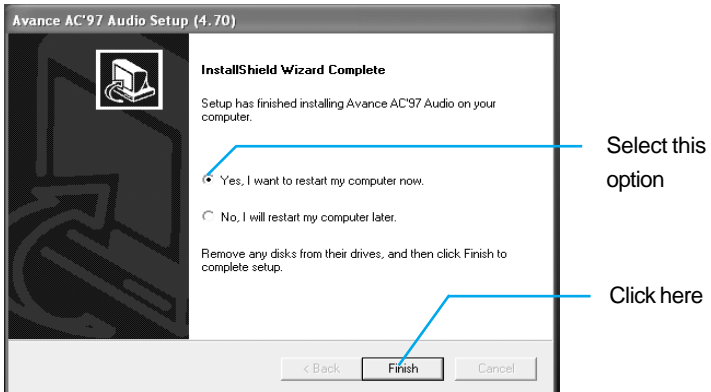

70

Attaching speakers

To perform multichannel audio operation, connect multiple speakers to the system. You should connect the same number of speakers as the audio channels you will select in the software utility.

2-Channel Analog Audio Output

The audio connectors on the back panel already provide 2-channel analog audio output function. The back panel's audio connectors can be transformed to 4/6-channel analog audio connectors automatically when you select correct setting in the software utility. For information about the setting, refer to Selecting 4- or 6-Channel Setting later in the section.

Make sure all speakers are connected to Line Out connectors. Diverse connector configurations for 2-, 4- and 6-channel using back panel connectors are described below:



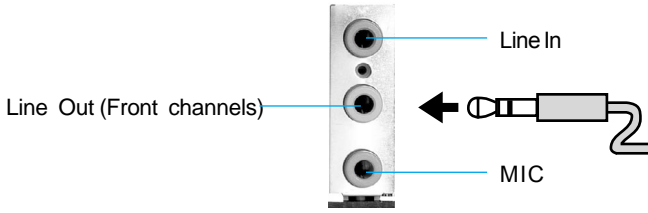

Description:

Line Out, Line In and MIC functions all exist under 2-channel configuration.

4-Channel Analog Audio Output

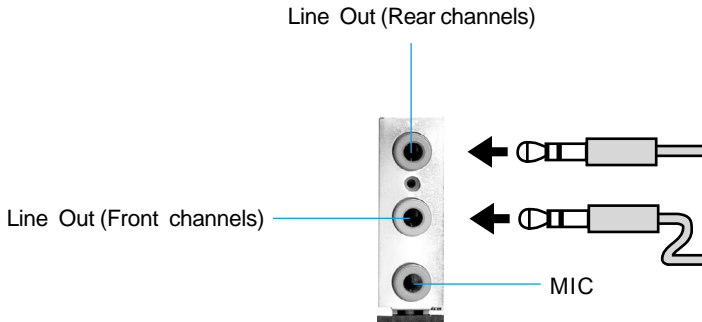

Description:

Line In is converted to Line Out function under 4-channel configuration.



6-Channel Analog Audio Output

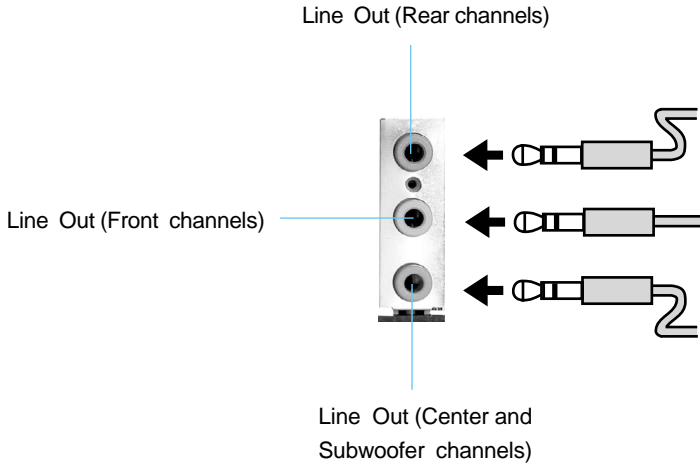

Description:

Both Line In and MIC are converted to Line Out function under 6-channel configuration.

72

Digital Audio Output

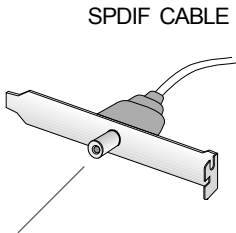

SPDIF CABLE

Coaxial SPDIF jack

or

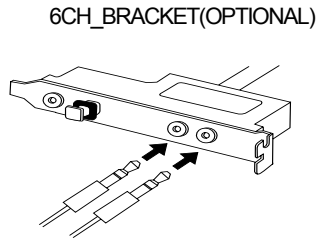

6CH_BRACKET(OPTIONAL)

The empty pin of SPDIF Cable is matched to pin 9 of 6CH_Bracket pin header (Please refer to page 18).

Description:

Connnet the SPDIF speakers to the Coaxial SPDIF jack.



Selecting 4- or 6-Channel Setting

1. Click the audio icon  from the window tray at the bottom of the screen.
2. Select any surround sound effect you prefer from the “Environment” pull-down menu under the **Sound Effect** tab.

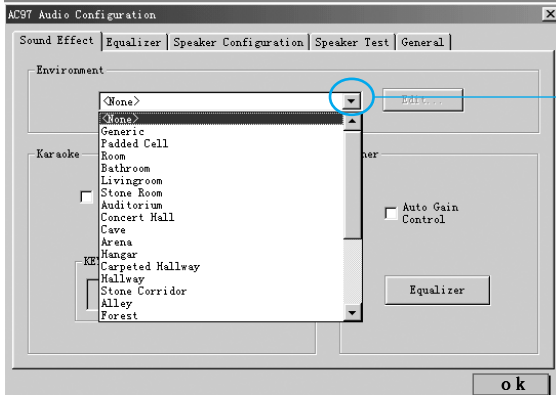

Click here and the pull-down menu will appear

3. Click the **Speaker Configuration** tab.

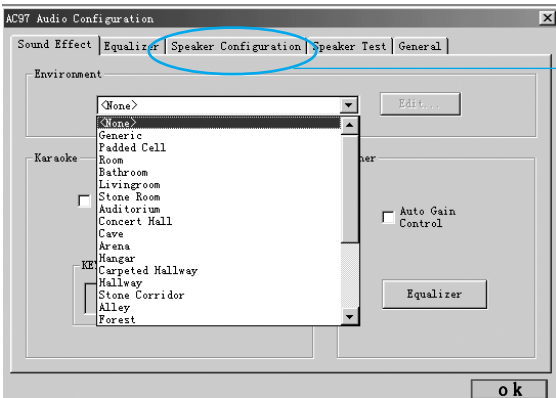

Click here



4. The following window appears.

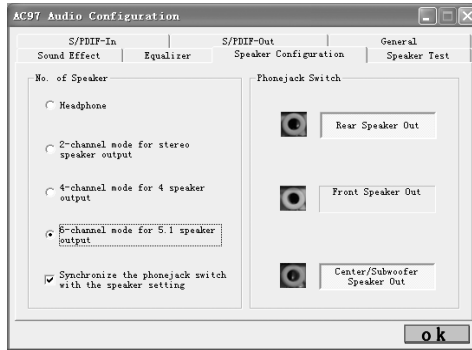

5. Select the multi-channel operation you prefer from **No. of Speaker**.
6. Click **OK**

74

Testing the Connected Speakers

To ensure 4- or 6-channel audio operation works properly, you may need to test each connected speaker to make sure every speaker work properly. If any speaker fails to sound, then check whether the cable is inserted firmly to the connector or replace the bad speakers with good ones.

Testing Each Speaker

1. Click the audio icon  from the window tray at the bottom of the screen.
2. Click the **Speaker Test** tab.



3. The following window appears.

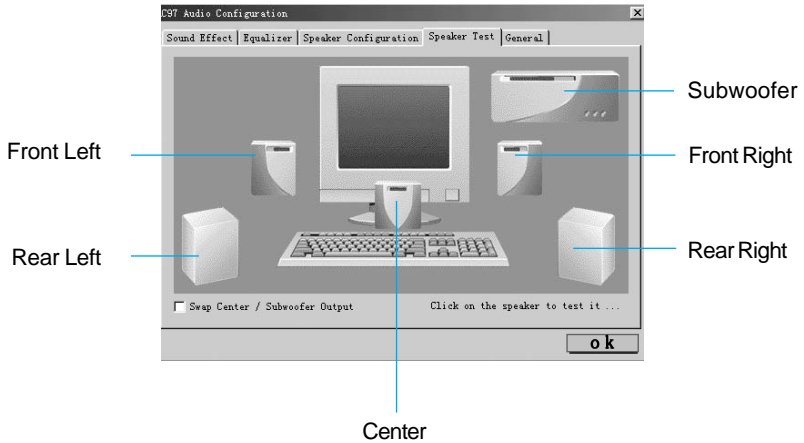

4. Select the speaker which you want to test by clicking on it.

Playing KaraOK

The KaraOK function will automatically remove human voice (lyrics) and leave melody for you to sing the song. **The function is applied only for 2-channel audio operation**, so make sure "2 channels mode" is selected in the "No. of Speakers" column before playing KaraOK.

Playing KaraOK

1. Click the audio icon  from the window tray at the bottom of the screen.
2. Make sure the **Sound Effect** tab is selected.



3. Select **Voice Cancellation** in the “KaraOK” column.

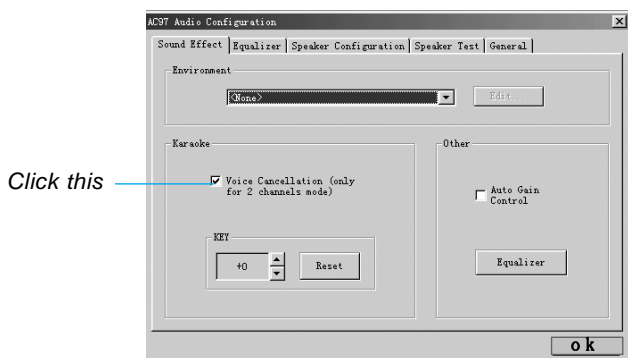

4. Click **OK**.



