

P3WMA or P3WMA-E series Quick Installation Chart

For your convenience, this chart lists all the CPUs supported by P3WMA or P3WMA-E series and their corresponding jumper setting.

Ratio	JF0	JF1	JF2	JF3
3.0x	1-2	2-3	1-2	1-2
3.5x	1-2	2-3	2-3	1-2
4.0x	2-3	1-2	1-2	1-2
4.5x	2-3	1-2	2-3	1-2
5.0x	2-3	2-3	1-2	1-2
5.5x	2-3	2-3	2-3	1-2
6.0x	1-2	1-2	1-2	2-3
6.5x	1-2	1-2	2-3	2-3
7.0x	1-2	2-3	1-2	2-3
7.5x	1-2	2-3	2-3	2-3
8.0x	2-3	1-2	1-2	2-3

*** The Ratio of some latest CPUs are fixed by Intel, such as Celeron/ Celeron III/ Pentium III 366, 400, 566... etc. You can ignore the four jumpers if you have this CPU on board and it will be auto detected by motherboard. Please check with the CPU manufacturer or vendor for the CPU Ratio information.

*** The CPU CLK over specification operation is optional. Please see session 3.9.3 for more information.

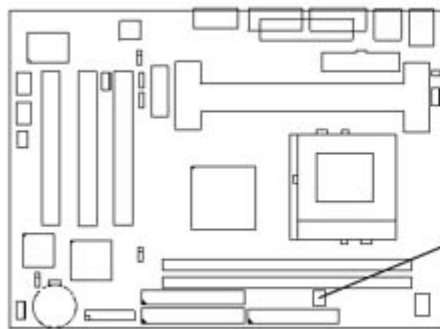

System bus multiplier for CPU clock

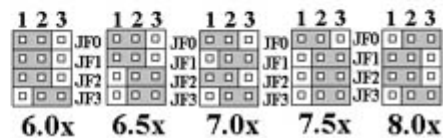
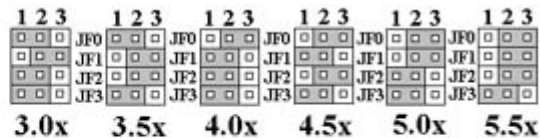

P3WMA

P3WMA-E

Motherboard User's Manual

Product Name:P3WMA or P3WMA-E series

Manual Revision: English, 1.3

Trademarks

Intel, Socket 370, Celeron, Pentium II and Pentium III are trademarks of Intel Corporation
Award is a trademark of Award Software International Inc.

MS-DOS, Windows 95, Windows 98 and Windows NT are registered trademarks of Microsoft Corporation
Novell is a trademark of Novell Corporation
Sound Blaster SB16 is a trademark of Creative Technology
ADI is a trademarks of Analog Devices Inc.,
All other brand and product names are trademarks or registered trademarks of their respective companies.

Table of Contents

Chapter 1. Introduction

- 1.1 Product Overview
- 1.2 Features
- 1.3 Specifications
- 1.4 Content
- 1.5 System Board Layout

Chapter 2. Hardware Setup

- 2.1 Installation Procedure
 - 2.1.1 Jumper Settings
 - 2.1.2 Enable/Disable Audio Codec
 - 2.1.3 Clearing the CMOS
 - 2.1.4 Keyboard Voltage Setting
 - 2.1.5 CPU FSB Frequency Setting
 - 2.1.6 CPU Voltage Setting
 - 2.1.7 CPU Frequency Setting
- 2.2 Installation of CPU
 - 2.2.1 For Celeron, Pentium II & III CPU
 - 2.2.2 For Socket 370 CPU
- 2.3 Installation of Memory
 - 2.3.1 Installation of 168-pin DIMM
 - 2.3.2 Removal of 168-pin DIMM
 - 2.3.3 Memory Configuration
- 2.4 I/O Connections/Panel Connections
 - 2.4.1 ATX Power Connector
 - 2.4.2 CPU/Chassis Fan Connector
 - 2.4.3 Wake-up on LAN Connector
 - 2.4.4 Creative's SB_LINK Sound Connector
 - 2.4.5 Floppy Disk Drive Connector
 - 2.4.6 Primary/Secondary IDE Connector
 - 2.4.7 Infrared Connector
 - 2.4.8 PS/2 Mouse Port
 - 2.4.9 PS/2 Keyboard Connector
 - 2.4.10 VGA Output Connector
 - 2.4.11 Serial Port
 - 2.4.12 Printer Port
 - 2.4.13 USB Connectors
 - 2.4.14 Line Out Connector
 - 2.4.15 Line In Connector
 - 2.4.16 Microphone In Connector
 - 2.4.17 Game/MIDI Port
 - 2.4.18 ATAPI IDE/SONY Audio
 - 2.4.19 Mitsumi Audio
 - 2.4.20 Panel Connection

Chapter 3. BIOS Setup

- 3.1 CMOS Setup Utility
- 3.2 Standard CMOS Features
- 3.3 Advanced BIOS Features Setup

- 3.4 Advanced Chipset Features Setup
- 3.5 Integrated Peripherals
- 3.6 Power Management Setup
- 3.7 PNP/PCI Configuration Setup
- 3.8 PC Health Status
- 3.9 Frequency Control
- 3.10 Load Fail-Safe Defaults
- 3.11 Load Optimized Defaults
- 3.12 Set Supervisor/User Password
- 3.13 Save & Exit Setup
- 3.14 Exit Without Saving

Chapter 4. Software Installation

- 4.1 INF Update for Windows 95/98/ME/2000
 - 4.1.1 For Windows 95/98 Gold Edition
 - 4.1.2 For Windows 98 SE
 - 4.1.3 For Windows 2000/ME
- 4.2 Installing the Graphics Driver
 - 4.2.1 For Windows 95/98/ME
 - 4.2.2 For Windows 2000
 - 4.2.3 For Windows NT 4.0
 - 4.2.4 For Windows 3.11, NT 3.51 & OS/2
- 4.3 Installing the Sound Driver
- 4.4 Installing the Intel Security Driver
- 4.5 Installing Ultra ATA Storage Driver
- 4.6 Installing Hardware Doctor

Appendix A Using the Suspend to RAM Function

Chapter 1. Introduction

1.1 Product Overview

Thank you for purchasing the **P3WMA series** motherboard. This motherboard utilizes **Intel's** latest Accelerated Hub Architecture technology. It uses **82810(DC100) or 82810E, 82801AA/AB & 82802AB** controller Hub. We have conducted a motherboard compatibility test with a variety of hardware and software, such as CPUs, memory, display cards, CD ROMs, Novell, MS Officeetc and has passed NSTL Year 2000 certification test program.

We have set high standards on our quality control, with absolute confidence, we believe this product is the wisest choice.

This manual is composed of four sections. The first section is the introduction of this motherboard, and the second section explains the proper procedure to setup the motherboard, the third section provides information on how to setup the CMOS. The last section states the device drivers & utilities installation .

1.2 Features

- Support Desktop Management Interface (DMI) through BIOS.
- Integrated Direct AGP Graphics/AC '97 controller.
- Support Ultra DMA 66.(for P3WMA, P3WMA-DC & P3WMA-E only)
- Support 133MHz FSB.(for P3WMA-E only)
- Modem Remote Ring On.
- Wake up on LAN.
- Wake on Keyboard.
- RTC Wake up Alarm: Program the date/time to wake up your system.
- Support NCR SCSI BIOS.
- Support Advanced Configuration Power Interface (ACPI).
- Low-power sleep modes, and 4Mbits "Plug & Play" Flash ROM.
- ADI AD1881 Audio CODEC on board .
- Support Hardware Monitor function.
- Allows CPU settings and easy overclocking of frequency and Vcore voltage.
- Support Suspend to RAM.
- Both the BIOS and hardware levels of the motherboard meet PC '99 compliant.

1.3 Specifications

- CPU** : - Supports Intel Socket 370, Celeron, Pentium II, Pentium III with 66/100 FSB Processors. P3WMA-E also supports 133MHz FSB processors.
- Chipset** : - Intel 82810DC100, 82801AA & 82802AB chipset for P3WMA-DC
Intel 82810, 82801AA & 82802AB chipset for P3WMA.
Intel 82810, 82801AB & 82802AB chipset for P3WMA-L.
Intel 82810E, 82801AA & 82802AB chipset for P3WMA-E.
- VGA** : - Integrated 4MB 32-bit 100MHz SDRAM display cache controller (for P3WMA-DC & P3WMA-E only) and a 24-bit 230MHz RAMDAC graphics controller.
- Integrated 2D & 3D Graphics Engines, Software DVD MPEG 2 playback with H/W Motion Compensation Engine.
- Shared System Memory Area 1MB. 60MB Dynamic Video Memory Allocation.
- DIMM** : - Supports PC100-compliant or faster SDRAM in 2 168-pin banks, each bank consists of 1x168-pin 64-bit DIMM socket, which can support memory sizes of 16/32/64/128/256 MB modules.
- IDE** : - Supports up to a maximum of 512 MB system memory
- Dual channel PIO and PCI Bus Master IDE ports support up to 4 EIDE devices for HDD or CD-ROM
- Supports PIO Mode 4 with data transfer rate up to 14 MB/Sec
- Supports Ultra DMA 33/66 with data transfer rate up to 33/66 MB/Sec (P3WMA-L supports UDMA 33 only)
- BIOS** : - 4Mbits Award BIOS v6.00PG with built-in Anti-Virus, DMI, ACPI support, and green function (Plug-and-Play BIOS)
- Supports CD-ROM/HD/SCSI/Floppy/LS120/ZIP and LAN boot up
- Supports NCR SCSI BIOS.
- I/O Devices** : - One FDD control port supports two of the 5.25" or 3.5" floppy drives up to 2.88 MB.
- Two high-speed 16550 UART compatible serial ports
- One parallel ports with ECP/ EPP compatibility.
- One PS/2 mouse port
- One PS/2 Keyboard connector
- IR Port** : - One IrDA/ASKIR compatible Infrared interface port. (Cable optional)
- USB Ports** : - Two Universal Serial Bus (USB) ports support up to 127 peripheral devices.
- Sound** : - ADI AD1881 Audio Codec
- AC '97 Rev 2.1 compliant
- 16-bit Stereo Full-Duplex Codex
- High quality Sample Rate Conversion (SRC) from 7kHz to 48kHz in 1Hz increments
- Phat Stereo 3D Stereo Enhancement
- Audio Amp Power Down Signal
- Extended 6-bit Master Volume Control
- DSP 16-bit Serial Port Format, Slot 16 Mode
- Split Power Supplies (3.3V Digital / 5V Analog)
- ATX Power** : - Supports Modem remote Ring-On function
- Supports software power off function
- Supports RTC Wake-Up.
- Supports Wake up on LAN.
- Supports Keyboard Wake-Up.
- Expansion Slots** : - Three 32-bit PCI expansion slots
- One Audio Modem Riser (AMR) slot
- Others** : - Supports Creative's Sound Blaster 16 compatibility for real-mode DOS games.
- Operating System** : - Supports Windows 3.x/95/98/2000, Windows NT, MS-DOS V6.22, OS/2, Novell, Unix, SCO UNIX.....
- Dimension** : - 244 mm x 190 mm Micro ATX Form factor

1.4 Content

The motherboard box contains the following items:

- One Motherboard

- One IDE Ribbon Cable
- One Floppy Ribbon Cable
- One Serial Ribbon Cable
- One Retention mechanism
- One Driver CD
- User's Manual & Quick Installation Chart

1.5 MotherBoard Layout

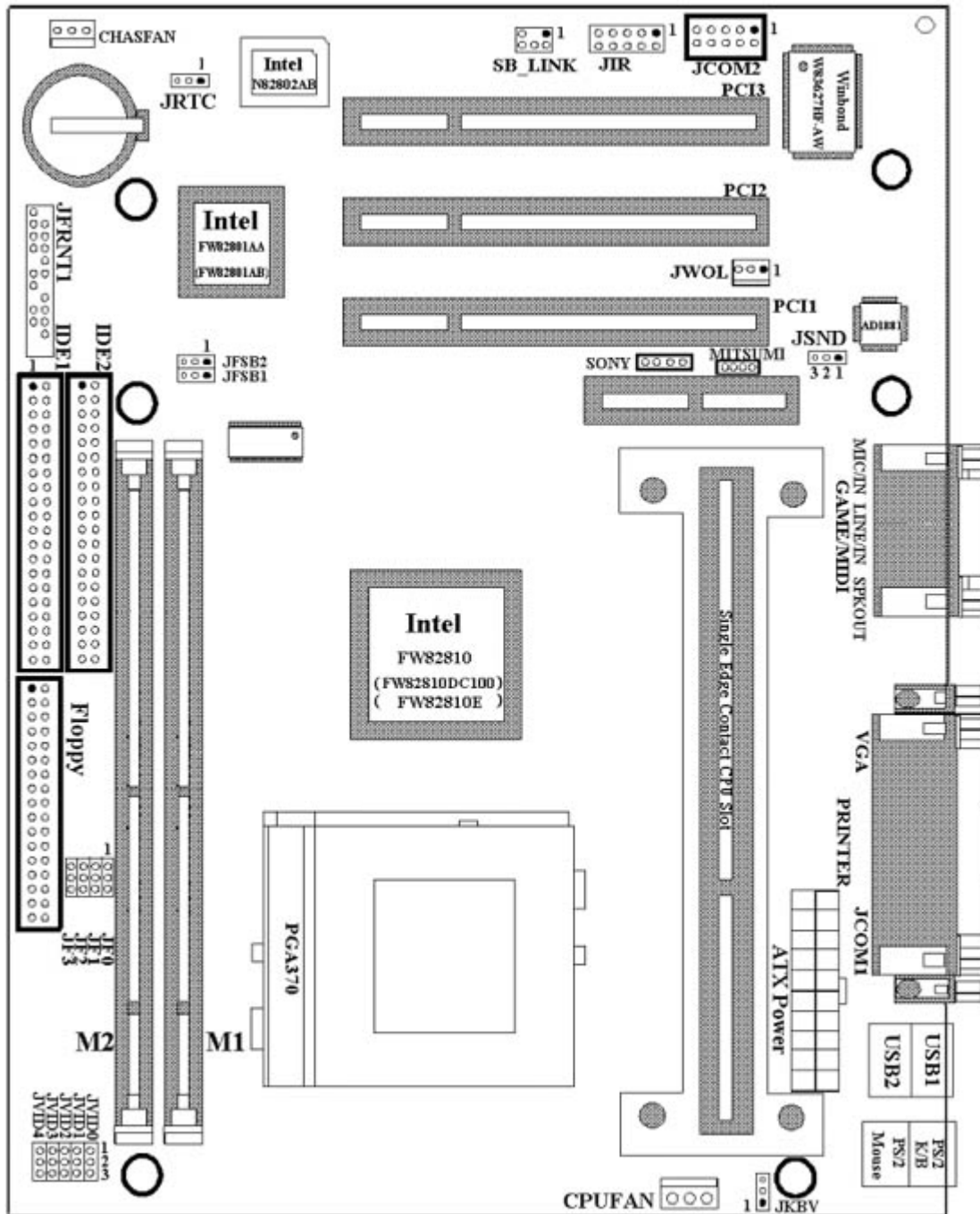

Notice:

- P3WMA has 82810, 82801AA & 82802AB chipset.
- P3WMA-L has 82810, 82801AB & 82802AB chipset.
- P3WMA-DC has 82810DC100, 82801AA & 82802AB chipset.
- P3WMA-E has 82810E, 82801AA & 82802AB chipset.

Chapter 2. Hardware Setup

2.1 Installation Procedure

1. Jumper settings
2. Installation of CPU
3. Installation of Memory
4. I/O Connections & Panel Connections

2.1.1 Jumper Settings

In this manual, **(1-2)** represents the first and second pins of the jumper. **(2-3)** represents the second and third pins of the jumper. On the motherboard, you will see two sets of jumpers with different color jumper caps:

- Yellow Jumper Caps: Sets the Function of Flash CMOS
JRTC
- Green Jumper Caps: Sets the type and speed of CPU
JF0, JF1, JF2, JF3
- Red Jumper Caps: Sets the FSB frequency of CPU JFSB
Sets the Vcore Voltage of CPU JVID
Sets the Keyboard Voltage JKBV
Enable/Disable Audio Codec function JSND (optional)

WARNING: Electronic parts are Static sensitive. To prevent damage to the computer and its parts please take the following measures.

- Work on a surface such as concrete, linoleum or hard wood floor.
- Ground your self with either a properly installed grounding strap or by touching a major electrical appliance long enough to discharge the static.

2.1.2 Enable/Disable Audio Codec (JSND : Red Jumper Cap) (The Audio Codec function and jumper are optional)

This jumper lets you to enable or disable the audio codec function.

- 1-2 : Enable Audio Coedc function (Default Setting)
2-3 : Disable Audio Coedc function

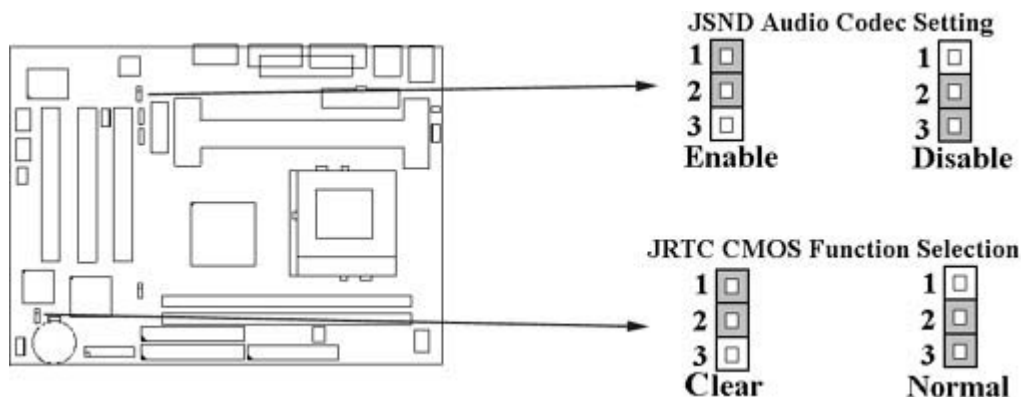

2.1.3 Clearing the CMOS (Yellow Jumper Cap)

- JRTC: CMOS Function Selection
1-2:Clear data
2-3:Normal Operation (Default Setting)

How to Clear the CMOS Setting

1. Turn off the power.
2. Remove ATX power cable from connector J1.
3. Remove Yellow Jumper Cap from JRTC (2-3) and put on JRTC (1-2) to remove the CMOS setting.
4. Remove Yellow Jumper Cap from JRTC (1-2) and put on JRTC (2-3).
5. Connect ATX power cable back to connector J1.
6. Turn on the power.
7. While the system reboots, press key to set the BIOS setup.

2.1.4 Keyboard Voltage Setting (Red Jumper Cap)

This motherboard supports wake on keyboard function. This feature requires that your system has an ATX power supply with at least 300mA +5V standby power and set this jumper to 2 & 3 pin short. Refer to session 3.5.9 for more information.

- 1-2 : 5V (Default Setting)
- 2-3 : 5V Stand By

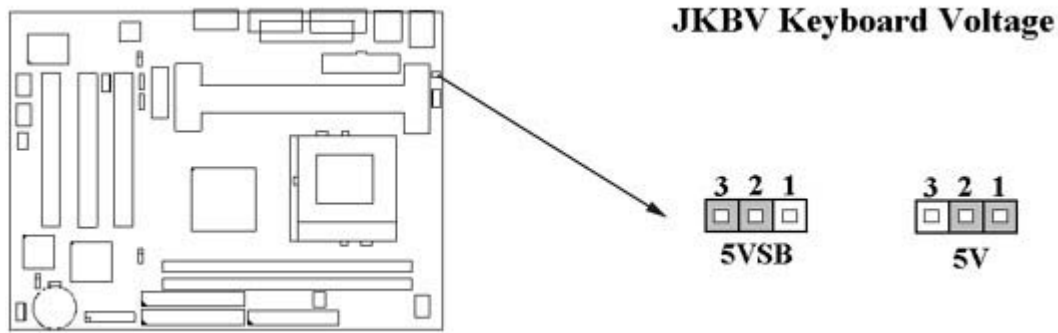

2.1.5 CPU FSB Frequency Setting (Red Jumper Caps)

The JFSB jumper provides some FSB frequency settings for the CPU. Auto Detect , 66MHz, 100MHz or 133MHz FSB frequency can be selected with this jumper. The over specification operation is not recommended.

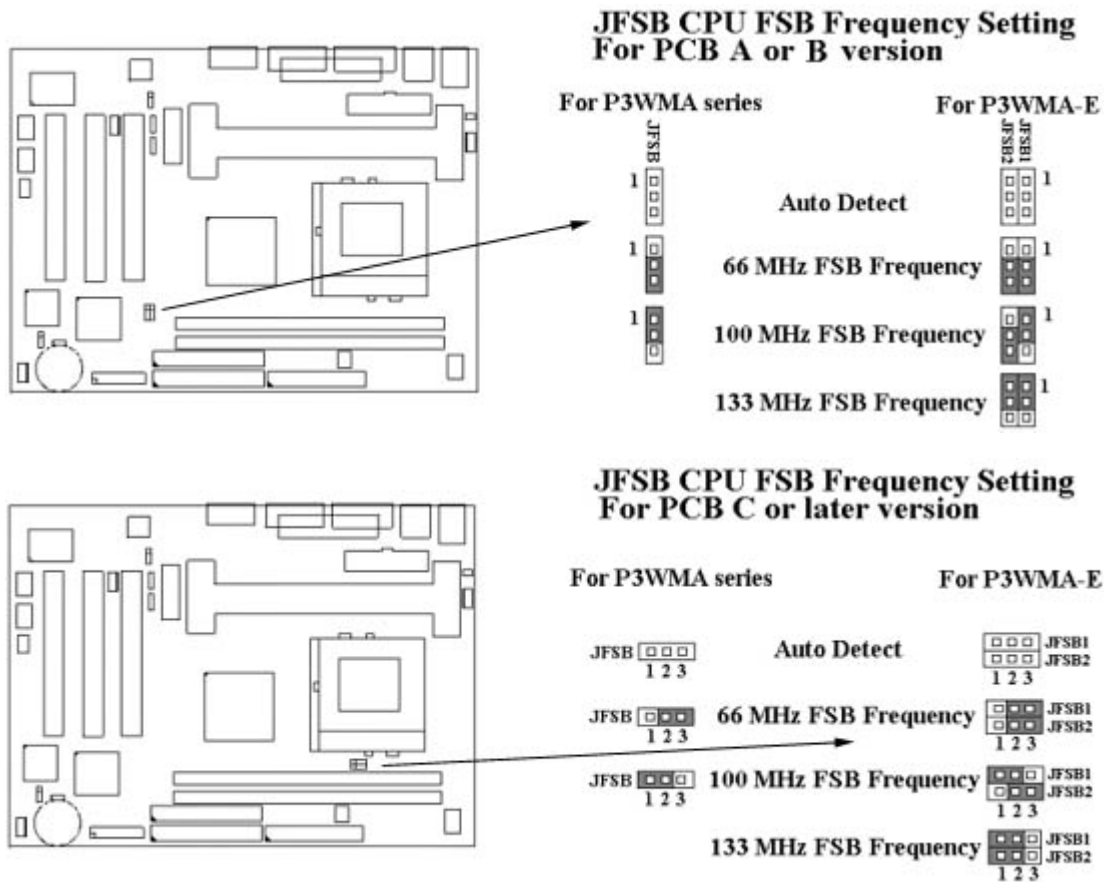

2.1.6 CPU Voltage Setting (Red Jumper Caps)

The motherboard supports CPU VID function. It supports auto detect mode and manual setting. When all of the JVID jumpers has no connection (N.C.) , the CPU core voltage is automatically detected, the range is from 1.3V to 3.5V for Pentium II & III CPU and. the range is from 1.3V to 2.0V for Socket 370 & Celeron CPU

Vcc2	JVID0	JVID1	JVID2	JVID3	JVID4
Auto Detect	N.C.	N.C.	N.C.	N.C.	N.C.
1.8V	1-2	2-3	1-2	2-3	2-3

1.85V	2-3	2-3	1-2	2-3	2-3
1.9V	1-2	1-2	2-3	2-3	2-3
1.95V	2-3	1-2	2-3	2-3	2-3
2.0V	1-2	2-3	2-3	2-3	2-3
2.05V	2-3	2-3	2-3	2-3	2-3
2.1V	2-3	1-2	1-2	1-2	1-2
2.2V	1-2	2-3	1-2	1-2	1-2

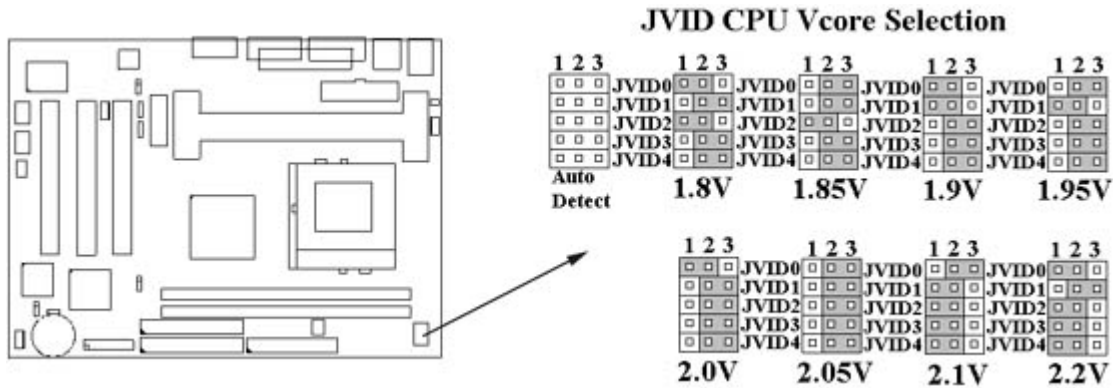

2.1.7 CPU Frequency Selection (Green Jumper Caps)

Ratio	JF0	JF1	JF2	JF3
3.0x	1-2	2-3	1-2	1-2
3.5x	1-2	2-3	2-3	1-2
4.0x	2-3	1-2	1-2	1-2
4.5x	2-3	1-2	2-3	1-2
5.0x	2-3	2-3	1-2	1-2
5.5x	2-3	2-3	2-3	1-2
6.0x	1-2	1-2	1-2	2-3
6.5x	1-2	1-2	2-3	2-3
7.0x	1-2	2-3	1-2	2-3
7.5x	1-2	2-3	2-3	2-3
8.0x	2-3	1-2	1-2	2-3

The Ratio of some latest CPUs are fixed by Intel, such as Celeron/ Celeron II/ Pentium III 366, 400, 566... etc. You can ignore the four jumpers if you have this CPU on board and it will be auto detected by motherboard. Please check with the CPU manufacturer or vendor for the CPU Ratio information.

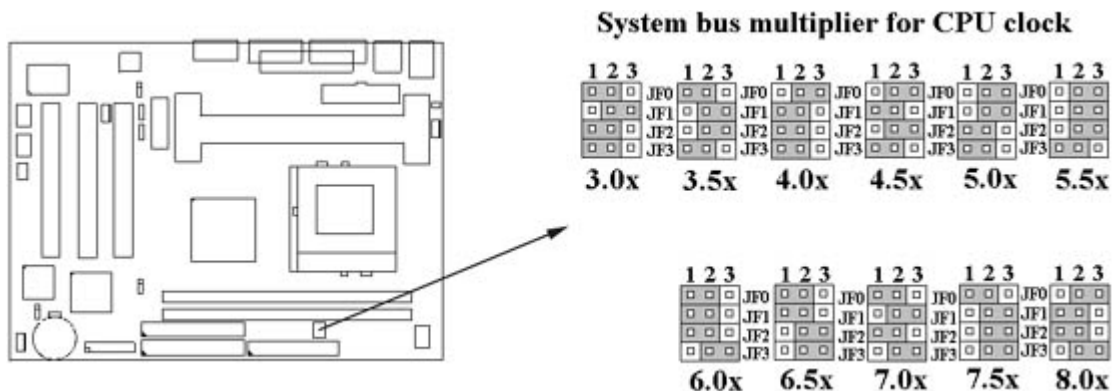

2.2 Installation of CPU

2.2.1 For Celeron, Pentium II & III CPU

The motherboard provides a Single Edge Contact(SEC)slot for processor packaged in an SEC cartridge. Follow these steps to install CPU:

Mount the Universal Retention Mechanism (URM) & Insert the CPU: (The illustration is just for reference)

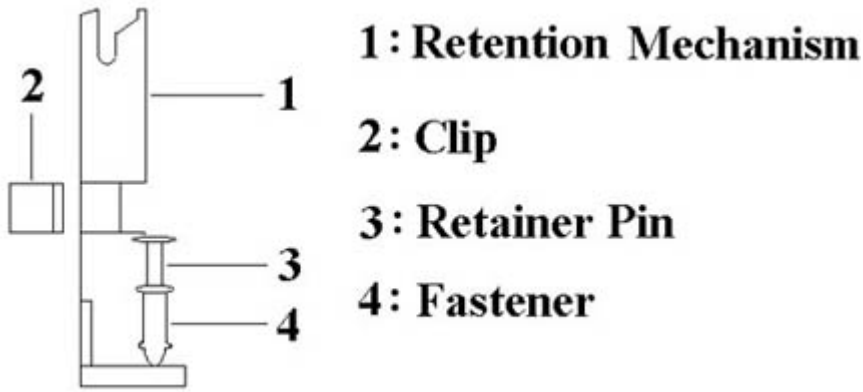

This URM was designed to accommodate 3 types of CPU Form Factor. (SECC, SECCII & SEPP). For Example : Pentium II/ III & Celeron family.

Note : Please put a soft pad under M/B before the installation of URM.

Installation for SECC CPU :

1. Leave space below each mounting hole for the fastener to protrude through the hole.
2. Position URM on the M/B next to the slot1 connector.
3. Push down retainer pin into respective fastener to secure URM onto the M/B.
4. Push CPU into URM to contact with slot1.
5. Make sure latching portion of CPU engaged with windows ledge of URM.

Installation for SECC II or SEPP CPU :

1. Same as step (1) of SECC.
2. Same as step (2) of SECC.
3. Same as step (3) of SECC.
4. Same as step (4) of SECC.
5. Snap in 2 clips into side windows of URM to secure SEPP CPU.

If there is a fan on the CPU, Please plug in the fan cable to the three pin fan connector on the motherboard (CPUFAN).

2.2.2 For Socket 370 CPU

Before installing CPU, make sure the power is off. Locate the level bar on the PGA370 ZIF socket. Push level bar away from the socket and pull upward 90 degrees. Insert the CPU into the socket. Make sure the notch of the CPU corresponds with the white dot on the ZIF socket (the corner without pin socket). Do not push in the CPU. Make sure all pins are aligned with the CPU socket. ON the level bar.

2.3 Installation of Memory

This motherboard has 2x168-pin 64-bit Dual Inline Memory Module (DIMM) sockets divided into 2 banks. You can install 3.3V Unbuffered PC100-compliant Synchronous DRAM (SDRAM) memory.

Some DIMM memory has SPD (Serial Presence Detect) 8-pin IC on module. When 2 piece DIMM on motherboard, it is not recommended the SPD (Serial Presence Detect) DIMM blends and non-SPD DIMM.

2.3.1 Installation of 168-pin DIMM (Dual Inline Memory Module)

1. Before inserting the DIMM, make sure the pin1 of the DIMM matches with the pin1 on the DIMM socket.
2. Insert DIMM into the DIMM sockets at a 90-degree angle and press down.

2.3.2 Removal of 168pin DIMM

1. Press the holding clips on both sides of the socket outward to release the DIMM.
2. Gently pull the DIMM out of the socket.

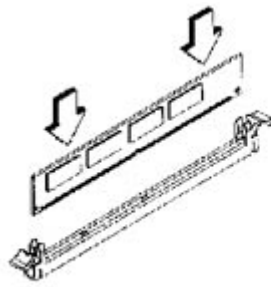

Install DIMM

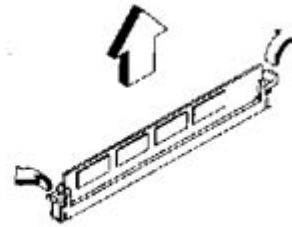

Remove DIMM

3.

2.3.3 Memory Configuration

There is no jumper setting required for the memory size or type. It is automatically detected by the system BIOS, and the total memory size is to add them together.

<i>DIMM Socket</i>	<i>DIMM Modules</i>
DIMM1	PC100 or faster SDRAM 16, 32, 64, 128, 256MB
DIMM2	PC100 or faster SDRAM 16, 32, 64, 128, 256MB

2.4 I/O Connections/Panel Connections

I/O Connections

J1	ATX Power Connector
CPUFAN	CPU fan connector
CHASFAN	Chassis fan connector
JIR	Infrared Connector (Cable optional)
JWOL	Wake up on LAN connector
SB_LINK	for link with Creative's Sound Blaster 16
FLOPPY	Floppy Disk Drive Connector
IDE1, 2	Primary/ Secondary IDE Connectors
MS	PS/2 Mouse Port
KB	PS/2 Keyboard Connector
VGA	VGA output Connector
COM1, 2	Serial Ports 1 & 2
PRINTER	Printer Port
USB	USB Connector
GAME	Game/MIDI Connectors
LINE_OUT	Line out Connector
LINE_IN	Line in Connector
MIC	Microphone in Connector
MITSUMI	The Connector for Mitsumi CD-ROM audio cable
SONY	The Connector for IDE/Sony CD-ROM audio cable

2.4.1 ATX Power Connector (20-pin J1)

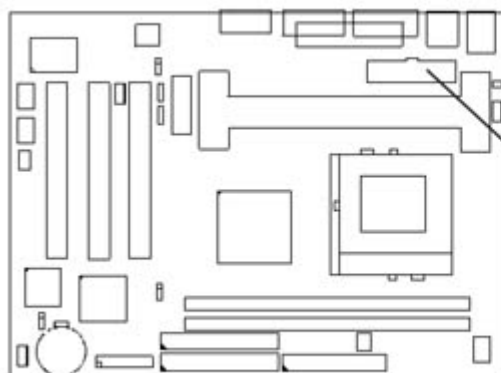

J1 ATX Power Connector

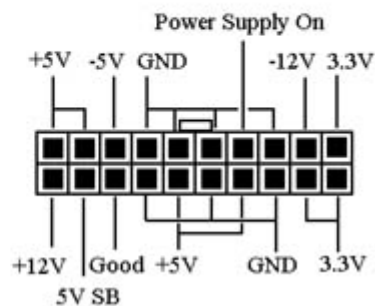

Make sure that the power supply is off before connecting or disconnecting the power cable.

2.4.2 CPU, Chassis Fan Connector (3-pin CPUFAN, CHASFAN)

Connect the fan's plug to the board taking into consideration the polarity of the connector.

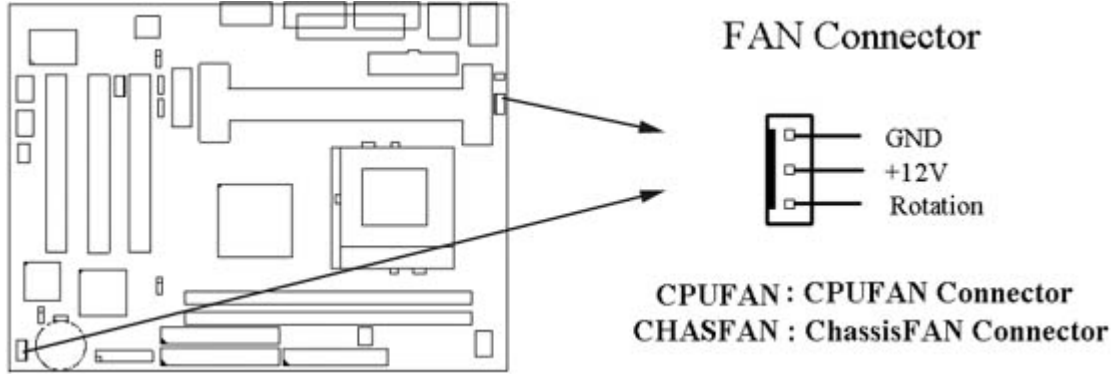

2.4.3 Wake-up on LAN Connector (3-pin JWOL)

The JWOL connector powers up the system when a wakeup packet or signal is received from the network . This feature requires the **Wake up on LAN** function in BIOS is set to Enabled and that your system has an ATX power supply with at least 720mA +5V standby power.

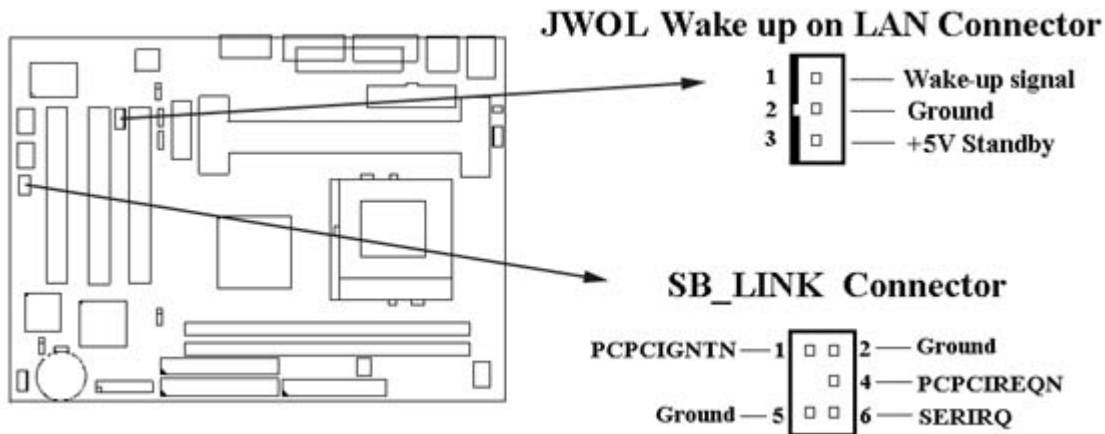

2.4.4 Creative's SB_LINK Sound Connector (6-pin SB_LINK)

The SB_LINK serves as a bridge between the mainboard and Creative's PCI sound card. This connector delivers Sound Blaster 16 compatibility for real-mode DOS games.

2.4.5 Floppy Disk Drive Connector (34-pin FLOPPY)

This connector supports the provided floppy disk drive ribbon cable. Orient the red stripe to pin 1

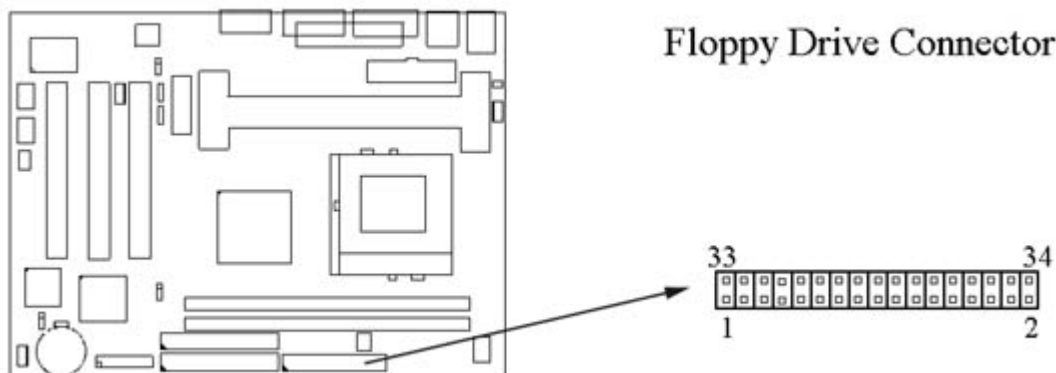

2.4.6 Primary/Secondary IDE Connector (Two 40-pin IDE)

IDE Connectors

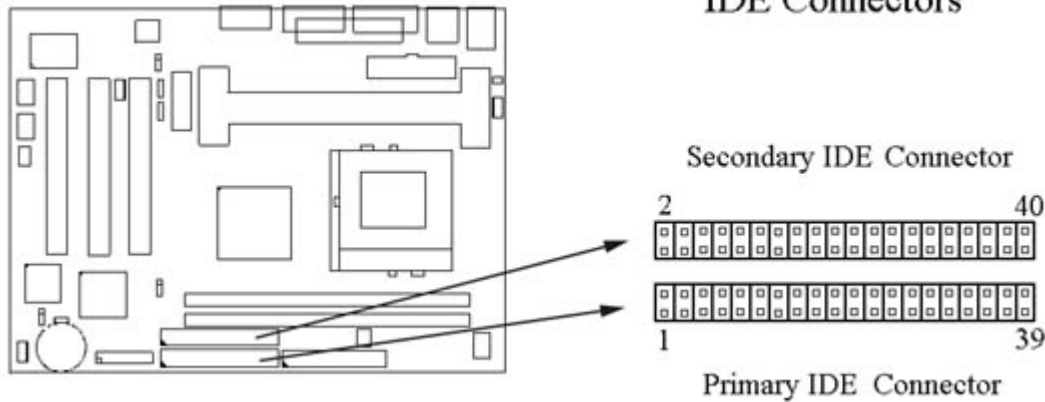

These connectors support the provided IDE hard disk ribbon cable. Connect your first IDE hard disk to master mode of the primary channel. If you have second IDE device to install in your system, connect it as slave mode on the same channel, and the third and fourth device can be connected on secondary channel as master and slave mode respectively.

2.4.7 Infrared Connector (10-pin JIR)

This connector supports the optional wireless transmitting and receiving infrared module, with this module and application software such as Laplink or Win95 Direct Cable Connection, user can transfer files to or from their laptops, notebooks, PDA, PCs and printers. The connector supports IrDA (115.2Kbps, 2 meters) and ASK-IR (56Kbps). An optional consumer infrared (CIR) set connects to the CIR and SIR connectors simultaneously for both wireless transmitting and remote control functions through one external infrared module. Install infrared module onto Infrared connector and configure the setting through "UART Mode Select" in **Integrated Peripherals** to select whether UART is directed for use with COM2 or Infrared.

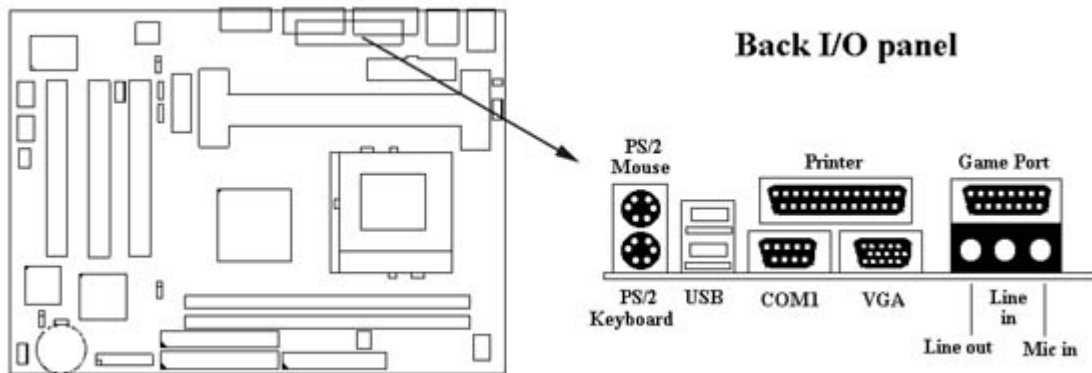
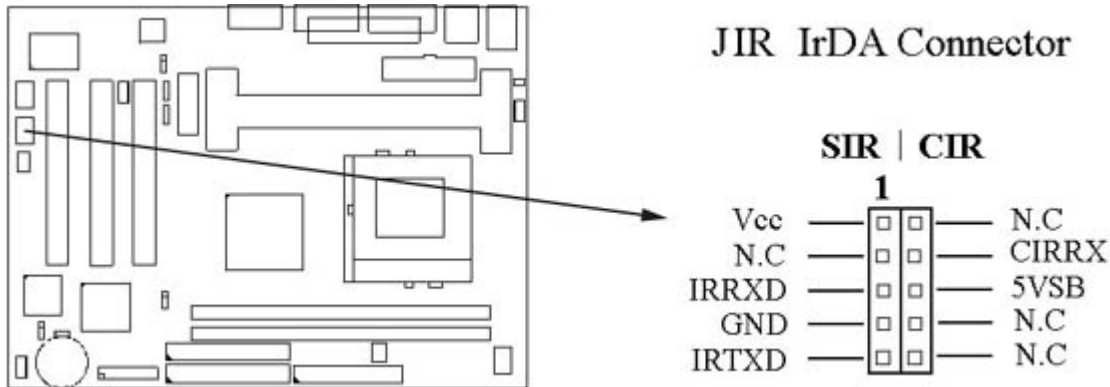

2.4.8 PS/2 Mouse Port (6-pin Mini-Din MS)

The system will direct IRQ12 to the PS/2 mouse.

2.4.9 PS/2 Keyboard Connector (6-pin Mini-Din KB)

This connection is for a standard keyboard using a PS/2 plug. You may use a Din to Mini-Din adapter on standard AT keyboards.

2.4.10 VGA Output Connector (15-pin female)

This connector is for output to a VGA-compatible device.

2.4.11 Serial Port (9-pin D-type COM1)

2.4.12 Printer Port (25-pin D-type PRINTER)

You can enable the parallel port and choose the IRQ through the “Onboard Parallel Port” setting in Integrated Peripherals of the CMOS SETUP UTILITY.

2.4.13 USB Connectors (Two 4-pin USB)

You can attach USB devices to the USB connector.

2.4.14 Line Out Connector (optional)

The Line Out phonejack provides the audio outputs for the left and right stereo channels.

2.4.15 Line In Connector (optional)

The Line In phonejack is used to attach monaural or stereo devices such as a cassette, Digital Audio Tape, or Minidisc players for playback, mixing, or recording.

2.4.16 Microphone In Connector (optional)

The Microphone In phonejack is used to attach a monaural microphone for live audio input for playback, mixing, or recording.

2.4.17 Game/MIDI Port (optional)

The Game/MIDI Port connector is used to attach a joystick for game interaction or to attach an external MIDI device for playback, mixing, or recording.

2.4.18 ATAPI IDE/Sony CD-ROM Audio (4-pin SONY) (optional)

The ATAPI IDE/Sony CD-ROM Audio connector is used to connect the audio cable from either an ATAPI IDE or Sony CD-ROM drive for playback, mixing, and recording.

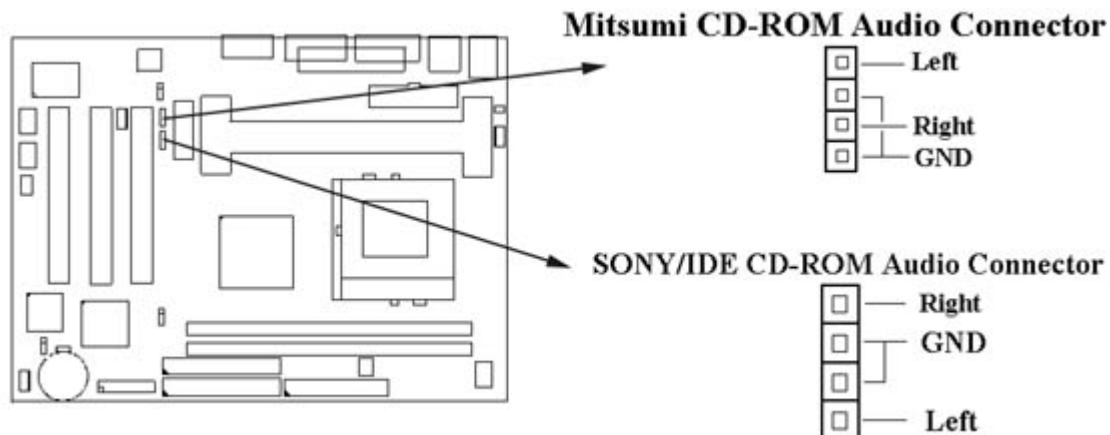

2.4.19 Mitsumi CD-ROM Audio (4-pin MITSUMI) (optional)

The Mitsumi CD-ROM Audio connector is used to connect the audio cable from a Mitsumi CD-ROM drive for playback, mixing, or recording. Only one of the two CD-ROM audio connectors may be used at a time.

2.4.20 Panel Connection (24-pin JFRNT)

JFRNT Connector	Function
GREENLED	Suspend Mode LED

PWRLED	Power LED
KEYLK	Keylock Switch
SPKR	Speaker
RESET	Reset Switch
IDELED	HDD LED
PWRBNT	ATX Power Button Connector

WARNING: To avoid the system from failing, turn off the power before connecting any devices to the system.

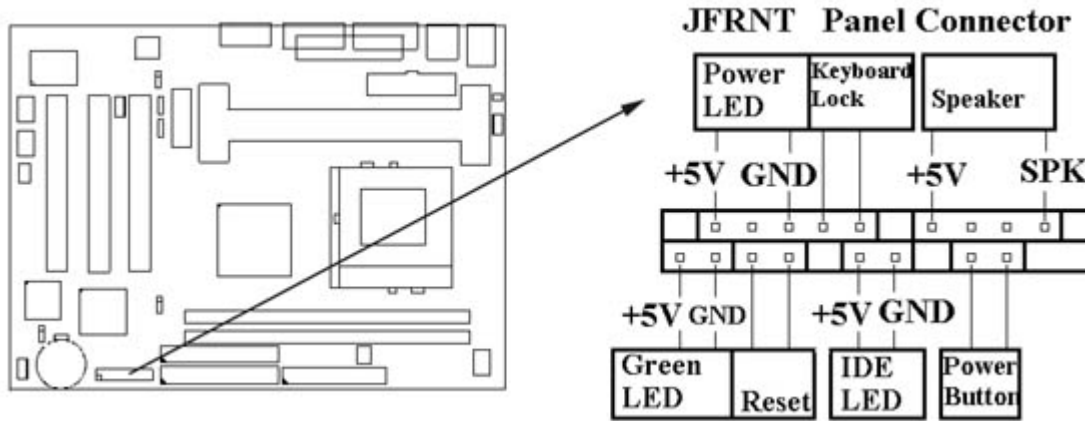

Chapter 3. BIOS Setup

3.1 CMOS Setup Utility

To activate CMOS Setup, press key immediately after you turn on the system. The following message "Press DEL to enter SETUP" should appear in the lower left hand corner of your screen.

When you enter the CMOS Setup Utility, the Main Menu will be displayed (**Figure 3-1**). You can use arrow keys to select your function, press <Enter> key to accept the selection and enter the sub-menu.

Figure 3-1. CMOS Setup Utility Main Screen

CMOS Setup Utility - Copyright (C) 1984 - 1999 Award Software

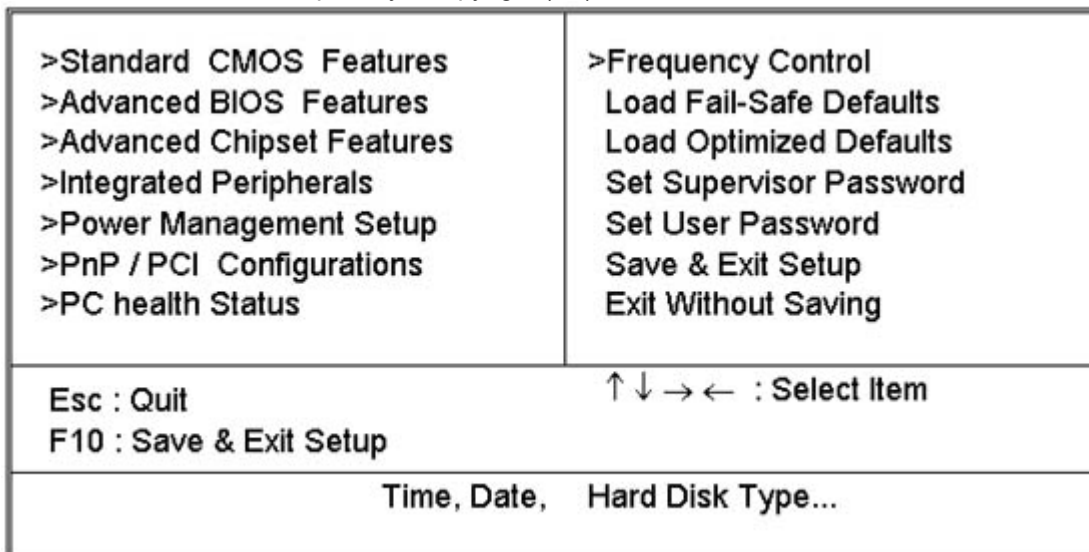

Sub-Menu

Note that a right pointer symbol appears to the left of certain fields. This pointer indicates that a sub-menu can be launched from this field. A sub-menu contains additional options for a field parameter. To call up a sub-menu, simply move the highlight to the field and press <Enter>. The sub-menu will then immediately appear. Use the

legend keys to enter values and move from field within a sub-menu just as you would within a menu. Use the <Esc> key to return to the main menu.

3.2 Standard CMOS Features

With the sub-menu (**Figure 3-2**), you can setup the; system date, system time, hard and floppy drive type, and display adapter type. Please refer to your equipment specification when changing the setup. Use arrow keys to highlight items, and use <PageUp>, <PageDown>, <+>, or <-> keys to scroll through the available options.

Figure 3-2. Standard CMOS Features Screen

CMOS Setup Utility - Copyright (C) 1984 - 1999 Award Software
Standard CMOS Features

Date (mm : dd : yy)	Fri, Jan 1 1999	Item Help
Time (hh : mm : ss)	1 : 28 : 42	Menu Level >
>IDE Primary Master	Press Enter 4403 MB	Change the day, month, Year and century
>IDE Primary Slave	Press Enter None	
>IDE Secondary Master	Press Enter None	
>IDE Secondary Slave	Press Enter None	
Drive A	1.44M, 3.5 in.	
Drive B	None	
Floppy 3 Mode Support	Disabled	
Video	EGA/VGA	
Halt On	All Errors	
Base Memory	640K	
Extended Memory	14336K	
Total Memory	15360K	

↑ ↓ → ← : Move Enter : Select +./PU/PD : Value F10 : Save ESC : Exit F1 : General Help
 F5 : Previous Value F6 : Fail-Safe Defaults F7 : Optimized Defaults

3.2.1 Date

To assign the system date, the format is "mm.dd.yy". The input range for the Month is 1-12. Range for Date is 1-31. Range for Year is 1994-2079. System BIOS will calculate the day of the week automatically.

3.2.2 Time

To assign the system time, the format is "hh:mm:ss". The setting is in military time. When entering 2:34pm enter "14:34:00".

3.2.3 Hard Disks Setting

The BIOS supports Dual-Channel PIO and PCI Bus Master IDE ports. Each port supports one master and one slave hard drive. You can use <Enter> or <PageUp> or <PageDown> key to change hard drive type. Incorrect setting may result in boot up error or system hang.

If your hard disk drive is not listed, you can select "Manual" mode to define your own drive manually. We recommend that you select Type"AUTO" for all drives. The BIOS will auto-detect the hard disk drive and CD-ROM drive at the POST stage.

If your hard disk drive is a SCSI device, please select "None" for your hard drive setting.

IDE HDD Auto-Detection	Press Enter	Item Help
IDE Primary Master Access Mode	Auto	Menu Level >>
Capacity	4303 MB	To auto-detect the HDD's size, head... on This channel
Cylinder	8894	
Head	15	
Precomp	0	
Landing Zone	8893	
Sector	63	

↑ ↓ → ← : Move Enter : Select +/-/PU/PD : Value F10 : Save ESC : Exit F1 : General Help
 F5 : Previous Value F6 : Fail-Safe Defaults F7 : Optimized Defaults

3.2.4 Floppy Drives A&B Setting

Select your floppy disk drive type. Options are 360KB (5.25"), 720KB (3.5"), 1.2MB (5.25"), 1.44MB (3.5"), 2.88MB (3.5").

3.2.5 Floppy 3 Mode Support

This is required to support older Japanese floppy drives. Floppy 3 Mode support will allow reading and writing of 1.2MB (as opposed to 1.44MB) on a 3.5-inch diskette.

3.2.6 Video Display Adapter Setting

Select the display adapter type for your system. Options are EGA/VGA, MONO, CGA40 and CGA80.

3.2.7 Halt On

This function allows the system to halt when an error is detected during Power-On Self-Test.

3.3 Advanced BIOS Features Setup

The sub-menu (**Figure 3-3**) includes all AWARD enhanced functions. The correct setting can enhance boot up efficiency. You can assign system speed, setup sequence, typematic and system password setting. You can enter <F1> key for help on highlighted topics. If you want to restore values before the changes you just made, press <F5> key. If you want to restore default value, press <F6> or <F7> key.

Figure 3-3. Advanced BIOS Features Screen

CMOS Setup Utility - Copyright (C) 1984 - 1999 Award Software
Advanced BIOS Features

Virus Warning	Disabled	Item	Help
CPU Internal Cache	Enabled		
External Cache	Enabled	Menu	Level >
CPU L2 Cache ECC Checking	Enabled		
Processor Number Feature	Disabled		
Quick Power On Self Test	Enabled		
First Boot Device	IDE-0		
Secondary Boot Device	Floppy		
Third Boot Device	SCSI		
Boot Other Device	Enabled		
Swap Floppy Drive	Disabled		
Boot Up Floppy Seek	Disabled		
Boot Up NumLock Status	On		
Gate A20 Option	Fast		
Typematic Rate Setting	Disabled		
X Typematic Rate (Chars/Sec)	6		
X Typematic Delay (Msec)	250		
Security Option	Setup		
OS Select For DRAM > 64MB	Non-OS2		
Report No FDD For WIN95	Yes		

↑ ↓ → ← : Move Enter : Select +/- /PU/PD : Value F10 : Save ESC : Exit F1 : General Help
 F5 : Previous Value F6 : Fail-Safe Defaults F7 : Optimized Defaults
 (Scroll down to see more items, as shown here)

3.3.1 Virus Warning

When enabled, the BIOS will monitor the boot sector and the partition table on the hard drive for any attempt to modify. If an attempt is detected, the BIOS will halt the system and prompt the warning message. Select "Disabled" if you are installing a new operating system.

3.3.2 CPU Internal/External Cache

These options are to enable or disable CPU Internal (L1) Cache, or External (L2) Cache.

3.3.3 CPU L2 Cache ECC Checking

Select 'Enabled' to enable CPU L2 Cache ECC Checking.
 Select 'Disabled' to disable CPU L2 Cache ECC Checking.

3.3.4 Processor Number Feature

This field will appear only when you are using a Pentium III processor. Each Pentium III processor comes with an individual "processor serial number" which by default is activated. Therefore, when connected to the internet, Pentium III processor transmits the serial number online making it possible to track your online activity. The field provides you the option of disabling this function.

3.3.5 Quick Power On Self Test

Select "Enabled" to speed up time required to complete Power-On Self-Test.

3.3.6 First/Second/Third Boot Device & Boot Other Device

This option allows user to assign boot sequence of the system. Available options are Floppy, HDD, CD-ROM, SCSI, LAN and LS120/ZIP. Set " Boot Other Device" to Enabled if you wish to boot from another device.

3.3.7 Swap Floppy Drive

When enabled, physical drive A will be assigned to logical drive B, and physical drive B will be assigned to logical drive A.

3.3.8 Boot Up Floppy Seek

The system will detect and verify operation of the floppy drive type .

3.3.9 Boot Up Numlock Status

The option allows the <NumLock> key to be activated after system boot up.

3.3.10 Gate A20 Option

This entry allows you to select how the gate A20 is handled. The gate A20 is a device used to address memory above 1 Mbytes. Initially, the gate A20 was handled via a pin on the keyboard (Normal). Today, while keyboards still provide this support, it is more common, and much faster, for the system chipset (Fast; default) to provide support for gate A20.

3.3.11 Typematic Rate Setting

Select "Enabled" to configure "Typematic Rate" and "Typematic Delay" functions.

3.3.12 Typematic Rate

Use this option to set the rate at which a character keeps repeating while you hold down a key.

3.3.13 Typematic Delay

Select "Enabled" to set the length of delay before key strokes to repeat. Available options are "250", "500", "750", and "1000".

3.3.14 Security Option

You can select whether the password is required every time the system boots or only when you enter the Setup. You can assign "Supervisor Password" and "User Password" in the main CMOS Setup Utility Screen.

3.3.15 OS Select for DRAM > 64MB

If you are using OS/2 operating system and installed memory is larger than 64MB. You need to have the setting in the enable mode.

3.3.16 Report No FDD For WIN 95

While the FDD in "STANDARD CMOS SETUP" is set to NONE, set this option to No to release IRQ6 for passing Win95 logo. This option is irrelevant under normal operation .

3.4 Advanced Chipset Features Setup

These settings are intended for the Advanced Chipset function on the motherboard. Fine tuning these options, enhances the performance of the system.

Figure 3.4 Advanced Chipset Features Screen

CMOS Setup Utility - Copyright (C) 1984 - 1999 Award Software
Advanced Chipset Features

SDRAM CAS Latency Time	3	Item Help
SDRAM Cycle Time Tras/Trc	6/8	Menu Level >
SDRAM RAS-TO-CAS Delay	3	
SDRAM RAS Precharge Time	3	
System BIOS Cacheable	Enabled	
Video BIOS Cacheable	Enabled	
Memory Hole At 15M-16M	Disabled	
Delayed Transaction	Disabled	
On-Chip Video Windows Size	64MB	
* Onboard Display Cache Setting *		
CAS# Latency	3	
Paging Mode Control	Close	
RAS-to-CAS Override	By CAS# LT	
RAS# Timing	Slow	
RAS# Precharge Timing	Slow	

↑ ↓ → ← : Move Enter : Select +/J/PU/PD : Value F10 : Save ESC : Exit F1 : General Help
F5 : Previous Value F6 : Fail-Safe Defaults F7 : Optimized Defaults

3.4.1 SDRAM CAS Latency Time

This controls the latency between the SDRAM read command and the time that the data actually becomes available.

3.4.2 SDRAM Cycle Time Tras/Trc

This feature controls the number of SDRAM clocks used per access cycle.

3.4.3 SDRAM RAS-to-CAS Delay

These are timing of SDRAM CAS Latency and RAS to CAS Delay, calculated by clocks. They are important parameters affects SDRAM performance.

3.4.4 SDRAM RAS Precharge Time

The RAS Recharge means the timing to inactive RAS and the timing for DRAM to do Recharge before next RAS can be issued.

3.4.5 System BIOS Cacheable

Allows the system BIOS to be cached for faster system performance.

3.4.6 Video BIOS Cacheable

Allows the video BIOS to be cached for faster video performance.

3.4.7 Memory Hole At 15M-16M

Enabling this feature reserves 15MB to 16MB memory address space to ISA expansion cards that specifically require this setting. This makes the memory from 15MB and up unavailable to the system. Expansion cards can only access memory up to 16MB.

3.4.8 Delayed Transaction

This function is used to meet the latency of PCI cycles to from ISA bus. Try to enable or disable it, if you have ISA card compatibility problem.

3.4.9 On-Chip Video Windows Size

This feature allows you to select the size of mapped memory for AGP graphic data.

3.4.10 CAS# Latency

This field is used to select the local memory clock periods. The options are 2 or 3.

3.4.11 Paging Mode Control

This field is used to select the paging mode control. The options are Open and Close.

3.4.12 RAS-to-CAS Override

This field is used to select the display cache clock periods control. The options are "by CAS# LT" and "Override(2)".

3.4.13 RAS# Timing

This field controls RAS# active to Protegra, and refresh to RAS# active delay (in local memory clocks). The options are Slow or Fast.

3.4.14 RAS# Precharge Timing

This field controls RAS# precharge (in local memory clocks). The options are Slow or Fast.

3.5 Integrated Peripherals

You can control Input and Output functions from this screen.

Figure 3-5 Integrated Peripherals

On-Chip Primary PCI IDE	Enabled	Item Help Menu Level >
On-Chip Secondary PCI IDE	Enabled	
IDE Primary Master PIO	Auto	
IDE Primary Slave PIO	Auto	
IDE Secondary Master PIO	Auto	
IDE Secondary Slave PIO	Auto	
IDE Primary Master UDMA	Auto	
IDE Primary Slave UDMA	Auto	
IDE Secondary Master UDMA	Auto	
IDE Secondary Slave UDMA	Auto	
USB Controller	Disabled	
X USB Keyboard Support	Disabled	
Init Display First	PCI Slot	
AC97 Audio	Auto	
AC97 Modem	Auto	
IDE HDD Block Mode	Enabled	
Power ON Function	Any Key	
X KB Power ON Function	Enter	
X Hot Key Power ON	Ctrl-F1	
<hr/>		
Onboard FDC Controller	Enabled	
Onboard Serial Port 1	3F8 / IRQ4	
Onboard Serial Port 2	2F8 / IRQ3	
UART Mode Select	Normal	
X RxD , TxD Active	Hi , Lo	
X IR Transmission delay	Enabled	
X UR2 Duplex Mode	Full	
Onboard Parallel Port	378 / IR7	
Parallel Port Mode	SPP	
EPP Mode Select	Epp1.7	
ECP Mode Use DMA	3	
PWRON After PWR-Fail	off	
Game Port Address	201	
Midi Port Address	290	
Midi port IRQ	5	

↑ ↓ → ← : Move Enter : Select +/PU/PA : Value F10 : Save ESC : Exit F1 : General Help
 F5 : Previous Value F6 : Fail-Safe Defaults F7 : Optimized Defaults

(Scroll down to see more items, as shown here)

3.5.1 On-Chip primary/Secondary PCI IDE

Select "Enabled" to activate each on-board IDE channel separately, Select "Disabled", if you install an add-on IDE Control card

3.5.2 IDE Primary & Secondary Master/Slave PIO

These four PIO fields let you set a PIO mode (0-4) for each of four IDE devices. When under "Auto" mode, the system automatically set the best mode for each device

3.5.3 IDE Primary & Secondary Master/Slave UDMA

When set to "Auto" mode, the system will detect if the hard drive supports Ultra DMA mode.

3.5.4 USB Controller

Select Enabled if your system contains a Universal Serial Bus (USB) controller.

3.5.5 USB Keyboard Support

This item lets you enable or disable the USB keyboard driver within the onboard BIOS.

3.5.6 Init Display First

Select "AGP" or "PCI Slot" for system to detect first when boot-up.

3.5.7 AC97 Audio/Modem

Allows the motherboard's BIOS to detect whether you are using any audio/modem device. If a audio/modem device is detected, the onboard audio/modem controller will be enabled; if no audio/modem is detected, the onboard audio/modem controller will be disabled. If you want to use different controller cards to connect audio and modem connectors, set these fields to Disabled.

3.5.8 IDE HDD Block Mode

This feature enhances disk performance by allowing multi-sector data transfers and eliminates the interrupt handling time for each sector.

3.5.9 POWER ON Function

This field allows you to use the keyboard to power-on the system. To use this function, make sure JKBV is set to 2-3 On- please refer to " Keyboard Voltage Setting " in Chapter 2 for more information.

Any Key:

Press any key to power-on the system.

Button Only:

System can be power on with Power Button.

Keyboard 98:

When this option is selected, press the "wake up" key of the Windows 98 compatible keyboard to power-on the system.

Password:

When this option is selected, move the cursor to the "KB Power On Password" field and press <Enter>. Enter your password. You can enter up to 5 characters. Type in exactly the same password to confirm, then press <Enter>.

Hot Key:

When this option is selected, move the cursor to the " Hot Key Power On " field to select a function key you would like to use to power-on the system. The options are from Ctrl-F1 to Ctrl-F12.

Mouse Left:

When this option is selected, double-click the left button of the mouse to power-on the system.

Mouse Right:

When this option is selected, double-click the right button of the mouse to power-on the system.

3.5.10 Onboard FDC Controller

Select "Enabled" to activate the on-board FDC
Select "Disabled" to activate an add-on FDC

3.5.11 Onboard Serial Port 1 & 2

Select an address and corresponding interrupt for the first/second serial port. The default value for the first serial port is "3F8/IRQ4" and the second serial port is "2F8/IRQ3".

3.5.12 UART Mode Select

Select to activate the Infrared transfer function.

3.5.13 RxD , TxD Active

This option are Hi, Lo; Lo, Hi; Lo, Lo ; Hi, Hi.

3.5.14 IR Transmission Delay

If this option is enabled, transmission of data will be slower. This is recommended when you encounter transmission problem with your device. .

3.5.15 Onboard Parallel Port

Select address and interrupt for the Parallel port.

3.5.16 Parallel Port Mode

Select an operating mode for the parallel port. Mode options are SPP, EPP, ECP and ECP+EPP.

3.5.17 EPP Mode Select

Set parallel port as EPP1.7 or EPP1.9.

3.5.18 ECP Mode Use DMA

Select a DMA channel if parallel port is set as ECP or ECP+EPP.

3.5.19 PWRON After PWR-Fail

Off:

When power returns after an AC power failure, the system's power is off. You must press the Power button to power-on the system.

On:

When power returns after an AC power failure, the system will automatically power-on.

Former-Sts:

When power returns after an AC power failure, the system will return to the state where you left off before power failure occurs. If the system's power is off when AC power failure occurs, it will remain off when power returns. If the system's power is on when AC power failure occurs, the system will power-on when power returns.

3.5.20 Game Port Address

This field sets the address of the onboard game port connector.

3.5.21 Midi Port Address

This field is used to select the midi port's address. If you have selected the midi port's address, you may select its IRQ in the " Midi Port IRQ ".

3.5.22 Midi Port IRQ

This field is used to select the midi port's IRQ.

3.6 Power Management Setup

Power management decreases power usage under the pre-defined standby time range.

Figure 3-6. Power Management Setup Screen

CMOS Setup Utility - Copyright (C) 1984 - 1999 Award Software
Power Management Setup

ACPI function	Disabled	Item Help
ACPI Suspend Type	S1 (POS)	Menu Level >
Power Management	User Define	
Video Off Method	V/H SYNC+Blank	
Video Off In Suspend	Yes	
Suspend Type	Stop Grant	
MODEM Use IRQ	3	
Suspend Mode	Disabled	
HDD Power Down	Disabled	
Soft-off by PWR-BTTN	Instant-off	
PowerOn by Ring	Disabled	
Wake up on LAN	Disabled	
CPU Thermal-Throttling	50.0%	
Resume by Alarm	Disabled	
x Date (of Month) Alarm	0	
x Time (hh:mm:ss) Alarm	0 0 0	
** Reload Global Timer Events **		
Primary IDE 0	Disabled	

Primary IDE 1	Disabled	
Secondary IDE 0	Disabled	
Secondary IDE 1	Disabled	
FDD, COM, LPT Port	Disabled	
PCI PIRQ [A-D]	Disabled	

↑ ↓ → ← : Move Enter : Select +/-/PU/PD : Value F10 : Save ESC : Exit F1 : General Help
F5 : Previous Value F6 : Fail-Safe Defaults F7 : Optimized Defaults
(Scroll down to see more items, as shown here)

3.6.1 ACPI Function

This item allows you to enable or disable the function of Advanced Configuration and Power Interface which offers improved power management .

3.6.2 ACPI Suspend Type

This field is used to select the type of Suspend function.

S1 (POS): Enables the Power On Suspend function.

S3 (STR): Enables the Suspend to RAM function. Refer to Appendix A.

3.6.3 Power Management

Mini Saving	System starts power saving function when the inactivity period exceeds 1 hour.
Max Saving	System starts power saving function when the inactivity period exceeds 1 min.
User Defined	Allows user to define the inactivity period before power saving function activates,

3.6.4 Video Off Method

This field defines the video off features. The following options are available: DPMS OFF, DPMS Reduce ON, Blank Screen, V/H SYNC+Blank, DPMS Standby, and DPMS Suspend. The DPMS (Display Power Management System) features allow the BIOS to control the video display card if it supports the DPMS feature.

3.6.5 Video Off In Suspend

This option is used to activate the video off feature when the system enters the suspend mode.

3.6.6 MODEM Use IRQ

This item tells the Power Management BIOS which IRQ is assigned to the installed MODEM. Option are NA, 3, 4, 5, 7, 9, 10 and 11.

3.6.7 Suspend Mode

System further shuts down all devices except for CPU itself. This is the third level of Power Management.

3.6.8 HDD Power Down

This instructs hard drives to shut off while in the Power Management modes.

3.6.9 Soft-off by PWR-BTTN

When set to "Delay 4 Sec.", the ATX switch can be used as a normal system power-off button when pressed for less than 4 seconds. 'Instant' disables the ATX switch function when the button is pressed under 4 seconds.

3.6.10 Power On by Ring

The option lets you specify enable or disable external Modem Wake Up function. The function of power on through modem when system is off.

To select "Enabled" : To let the system to enter the environment of DOS or Windows 95/98 OS before system is power off. As long as there are any message through the Modem to enter the System during system is power off. The system will enable power on function.

3.6.11 Wake up on LAN

This allows you to remotely power up your system through your network by sending a wake-up frame or signal. With this feature, you can remotely upload/download data to/from systems during off-peak hours. Set to Enabled to set this feature.

3.6.12 CPU Thermal-Throttling

Set the percent of power consumption when CPU over heat.

3.6.13 Resume by Alarm

Set this option to enable or disable the RTC Alarm to Wake Up the system which is set at soft Off.

3.6.14 Date (of Month) Alarm, Time (hh:mm:ss) Alarm

Set these options to specify the RTC Alarm time on Date / Hour / Minute / Second.

3.6.15 Primary/Secondary IDE 0/1, FDD, COM, LPT Port & PCI PIRQ [A-D]

These items enable or disable the detection of IDE, floppy, serial, parallel port and PCI PIRQ [A-D] activities for power down state transition. Actually it detects the read/write to/from I/O port.

3.7 PNP/PCI Configuration Setup

Figure 3.7 PNP/PCI CONFIGURATION SETUP

CMOS Setup Utility - Copyright (C) 1984 - 1999 Award Software
PnP / PCI Configurations

Reset Configuration Data	Disabled	Item Help Menu Level >
Resources Controlled By x IRQ Resources	Auto (ESCD) Press Enter	
PCI/VGA Palette Snoop	Disabled	

↑ ↓ → ← : Move Enter : Select +/- / P U / PD : Value F10 : Save ESC : Exit F1 : General Help
F5 : Previous Value F6 : Fail-Safe Defaults F7 : Optimized Defaults

3.7.1 Reset Configuration Data

In case a conflict occurs after you assign the IRQs or after you configure your system, you can enable this function to allow your system to automatically reset your configuration and reassign the IRQs, DMAs, and I/O address.

3.7.2 Resources Controlled By

Default setting is "Auto (ESCD)". This setting allows the BIOS to self detect setting and Plug-and-Play devices during start up. The user can select and configure IRQs under "Manual" mode.

3.7.3 IRQ Resources

CMOS Setup Utility - Copyright (C) 1984 - 1999 Award Software
IRQ Resources

IRQ-3	assigned to	PCI/ISA PnP	Item Help
IRQ-4	assigned to	PCI/ISA PnP	Menu Level >
IRQ-5	assigned to	PCI/ISA PnP	
IRQ-7	assigned to	PCI/ISA PnP	
IRQ-9	assigned to	PCI/ISA PnP	
IRQ-10	assigned to	PCI/ISA PnP	
IRQ-11	assigned to	PCI/ISA PnP	
IRQ-12	assigned to	PCI/ISA PnP	
IRQ-14	assigned to	PCI/ISA PnP	
IRQ-15	assigned to	PCI/ISA PnP	

↑ ↓ → ← : Move Enter : Select +/PU/PD : Value F10 : Save ESC : Exit F1 : General Help
F5 : Previous Value F6 : Fail-Safe Defaults F7 : Optimized Defaults

3.7.4 IRQ-xx assigned to

If your ISA card is not PnP compatible and requires a special IRQ to support its function, set the selected IRQ-x assigned to : "Legacy ISA". This setting informs the PnP BIOS to reserve the selected IRQ for the installed legacy ISA card.

3.7.5 PCI/VGA Palette Snoop

Enable this option to correct screen color shifts, when there is a combination of VGA cards, accelerator cards, or MPEG cards present.

3.8 PC Health Status

Figure 3.8 PC Health Status

CMOS Setup Utility - Copyright (C) 1984 - 1999 Award Software
PC Health Status

CPU Warning Temperature	50 ° C/122 ° F	Item Help Menu Level >
Current System Temp.	26 ° C/78 ° F	
Current CPU Temperature	36 ° C/96 ° F	
Current CPUFAN Speed	4017 RPM	
Current ChassisFAN Speed	0 RPM	
Vcore(V)	1.98 V	
Vcc (V)	3.24 V	
+ 5 V	5.02 V	
+12V	11.73 V	
-12V	-11.78 V	
-5V	- 5.04 V	
VBAT (V)	2.96 V	
5VSB (V)	5.29 V	

↑↓→←: Move Enter: Select +/-/PU/PD: Value F10: Save ESC: Exit F1: General Help
F5: Previous Value F6: Fail-Safe Defaults F7: Optimized Defaults

3.8.1 Current System & CPU Temperature (xx°C/xx°F)

The onboard hardware monitor is able to detect the temperatures of motherboard and CPU. These values refresh upon any key entry. The function is optional.

3.8.2 Current CPUFAN & ChassisFAN Speed (xxxxRPM)

The onboard hardware monitor is able to detect chassis fan speed, CPU fan speed in Rotations Per Minute (RPM). These values refresh upon any key entry in the BIOS setup screen. The function is optional.

3.8.3 Vcore, Vcc3, +5V, +12V, -12V, -5V, VBAT & 5VSB (xx.xxV)

The onboard hardware monitor is able to detect the voltage output by the voltage regulators. These values refresh upon any key entry. The function is optional.

3.9 Frequency Control

Figure 3.9 Frequency Control

CMOS Setup Utility - Copyright (C) 1984 - 1999 Award Software
Frequency Control

Auto Detect DIMM/PCI CLK	Enabled	Item Help Menu Level >
Spread Spectrum	Disabled	
CPU Host/PCI Clock	Default	

↑↓→←: Move Enter: Select +/-/PU/PD: Value F10: Save ESC: Exit F1: General Help
F5: Previous Value F6: Fail-Safe Defaults F7: Optimized Defaults

3.9.1 Auto Detect DIMM/PCI CLK

If you have the EMI issue, set the option as Enabled, it keeps its interference under control.

3.9.2 Spread Spectrum

Using the default setting , this will increase the system stability.

3.9.3 CPU Host/PCI Clock

Choose Default, 66, 75, 83, 100, 105, 114, 120, 124 or 133 Mhz for the external frequency of your CPU. You can select Default, 66, 75 or 83Mhz if your CPU is 66Mhz FSB and select Default, 100, 105, 114, 120, 124 or 133 Mhz if the CPU is 100Mhz FSB.

The 75, 83, 105, 114, 120, 124 and 133 Mhz frequency are optional.

The frequency mapping table of the elements:

Ext. frequency	PCI	DIMM
66Mhz	33Mhz	100Mhz
75Mhz	37.5Mhz	112.5Mhz
83Mhz	41.6Mhz	124.9Mhz
100Mhz	33Mhz	100Mhz
105Mhz	35Mhz	105Mhz
114Mhz	38Mhz	114Mhz
120Mhz	40Mhz	120Mhz
124Mhz	41.33Mhz	124Mhz
133Mhz	44.33Mhz	133Mhz

Notice:

The 75, 83, 105, 114, 120, 124 and 133Mhz frequency are over specification.

You must install 8ns or faster DIMM on board if you set 105, 114, 120 or 124 Mhz as external frequency and must install 7ns or faster DIMM on board if you set 133Mhz as external frequency.

Warning: Over specification operations are not recommended.

3.10 Load Fail-Safe Defaults

This loads the troubleshooting default values permanently stored in the ROM chips. These settings are not optimal and turn off all high performance features. You should use these values only if you have hardware problems. Highlight this option in the main menu and press <Enter>. The message below will appear.

Load Fail-Safe Defaults (Y/N)?N

If you want to process, type <Y> and press <Enter>. The default settings will be loaded.

3.11 Load Optimized Defaults

This feature loads optimized setting from the BIOS ROM. Use the default values as standard values for your system. Highlight this option in the main menu and press <Enter>. The message below will appear.

Load Optimized Defaults (Y/N)?N

Type <Y> and press <Enter> to load the Setup default values.

3.12 Set Supervisor/User Password

You can assign, modify, or cancel password settings. To modify, highlight "Set Supervisor Password" or "Set User Password" and press the <Enter> key. The screen will prompt you ("Enter Password"). Enter your password. The maximum size of the password is 8 characters. System will prompt you to reenter the password to verify. Remember the passwords are case sensitive.

If you want to remove the passwords, either delete passwords or press <Enter> when prompting for new password.

If you want it to require password upon initial system startup and upon entering the CMOS Setup Utility, you will need to change

the selection of the (Security Option) under (Advanced BIOS Features) to "System".

If the setting is "Setup", the system will only require the password you activate CMOS Setup Utility.

3.13 Save & Exit Setup

When all the changes have been made, highlight "Save & Exit Setup" and press <Enter>. The message below will appear:

Save to CMOS and Exit (Y/N)? N

Type "Y" and press <Enter>. The modifications you have made will be written into the CMOS memory, and the system will reboot.

3.14 Exit Without Saving

When you do not want to save the changes you have made, highlight "Exit Without Saving" and press <Enter>. The message below will appear:

Quit Without Saving (Y/N)? N

Type "Y" and press <Enter>. The system will reboot .

Chapter 4. Software installation

4.1 INF Update for Windows 95/98/ME/2000

***** Because some controllers that in Intel 82810xx/82801xx Chipset are not recognized by Windows 95/98/ME/2000. You need to setup INF files to your system in order to enable these controllers. If your Operation System is Windows 95/98/ME/2000, you must setup INF files from \INTEL\WINDOWS\INF and \INTEL\WINDOWS\INF_INSTALL_UTILITY sub-directory first. Please follow installation below to setup INF files.**

4.1.1 For Windows 95/98 Gold Edition Installation

1. Start up Windows 95 or Windows 98 gold edition. [If your Windows 95 is older version, please install the USB supplement service pack (usbsupp.exe) files first. You can get this file from <http://www.microsoft.com>]
2. Insert the CD Driver into the CD drive-enter the \INTEL\WINDOWS\INF directory on the CD-ROM and double-click SETUP.EXE.
3. Follow the prompts to complete the installation and restart your computer.
4. Then enter the \INTEL\WINDOWS\INF_INSTALL_UTILITY directory on the CD-ROM and double-click SETUP.EXE.
5. Follow the prompts to complete the installation and restart your computer.
6. Add New Hardware Wizard will search for some devices.
7. If Insert Disk dialog is displayed, please insert the Windows 95 or 98 CD-ROM into the CD drive, then click "OK" button.
8. Click "Yes" button to restart your computer.

4.1.2 For Windows 98 SE

1. Insert the CD Driver into the CD drive-enter the \INTEL\WINDOWS\INF directory on the CD-ROM and double-click SETUP.EXE.
2. Follow the prompts to complete the installation and restart your computer.
3. Then enter the \INTEL\WINDOWS\INF_INSTALL_UTILITY directory on the CD-ROM and double-click SETUP.EXE.
4. Follow the prompts to complete the installation and restart your computer.

4.1.3 For Windows 2000/ME

1. Insert the CD Driver into the CD drive-enter the \INTEL\WINDOWS\INF directory on the CD-ROM and double-click SETUP.EXE.
2. Follow the prompts to continue the installation and restart your computer.

4.2 Installing the Graphics Driver

4.2.1 For Windows 95/98/ME

1. If your Operation System is Windows 95, please load DCOM95.EXE file from \INTEL\VGA\WIN9X\GRAPHICS directory first.
2. Insert the CD Driver into CD drive - enter the \INTEL\VGA\WIN9X\GRAPHICS directory on the CD Driver and double-click SETUP.EXE.
3. Click "Next" at the Welcome screen.
4. Follow the prompts to complete the installation.
5. You must restart your computer for the installation to complete.

4.2.2 For Windows 2000

1. Insert the CD Driver into CD drive - enter the \INTEL\VGA\WIN2000 directory on the CD Driver and double-click SETUP.EXE.

2. Click "Next" at the Welcome screen.
3. Follow the prompts to complete the installation.
4. You must restart your computer for the installation to complete.

4.2.3 For Windows NT 4.0

1. Start up Windows NT4.0 with service pack 4 or later version.
2. Insert the CD Driver into CD drive - enter the \INTEL\VGA\WINNT4\GRAPHICS directory on the CD Driver and double-click SETUP.EXE.
3. Click "Next" at the Welcome screen.
4. Follow the prompts to complete the installation.
5. You must restart your computer for the installation to complete.

4.2.4 For Windows NT 3.51, Windows 3.11 & OS/2

Please refer to the readme.txt file that in sub-directory to load the graphics driver.

4.3 Installing the Sound Driver

Please refer to the readme.txt file that in \ADI\188X directory first before installing the sound driver.

4.4 Installing the Intel Security Driver

1. Start up Windows 95/98/ME or NT 4.0
2. Insert the CD-ROM into the drive -enter the \INTEL\SecurityDRV directory on the CD-ROM and double-click SETUP.EXE
3. Follow the prompts to complete the installation and restart your system.
4. Please refer to the IntelSecurityDriver_Readme.txt file for more information.

4.5 Installing Ultra ATA Storage Driver

1. Start up Windows 98/98SE/ME/2000 or NT 4.0
2. Insert the CD-ROM into the drive -enter the \INTEL\ULTRAATA directory on the CD-ROM and double-click ULTRAATA.EXE
3. Follow the prompts to complete the installation and restart your system.

4.6 Installing Hardware Doctor Utility

Insert the CD Driver into the CD drive. Install SETUP.EXE from \MONITOR\W83627\WIN9598ME directory for Windows 95/98/ME or \MONITOR\W83627\W2K-NT40 directory for Windows 2000/NT4.0 then follow the prompts to complete the installation.

Appendix A. Using the Suspend to RAM Function

1. Select "Power Management Setup" in the main menu screen and press <Enter>.
2. In the "ACPI Function" field, select "Enabled".
3. In the "ACPI Suspend Type" field, select "S3(STR)".

CMOS Setup Utility - Copyright (C) 1984 - 1999 Award Software
Power Management Setup

ACPI function	Enabled	Item Help
ACPI Suspend Type	S3 (STR)	Menu Level
Power Management	User Define	
Video Off Method	V/H SYNC+Blank	
Video Off In Suspend	Yes	
Suspend Type	Stop Grant	
MODEM Use IRQ	3	
Suspend Mode	Disabled	
HDD Power Down	Disabled	
Soft-off by PWR-BTTN	Instant-off	
Power On by Ring	Disabled	
Wake up on LAN	Disabled	
CPU Thermal-Throttling	50.0%	
Resume by Alarm	Disabled	
x Date (of Month) Alarm	0	
x Time (hh:mm:ss) Alarm	0 0 0	
** Reload Global Timer		
Events **		
Primary IDE 0	Disabled	

↑↓ →←: Move Enter: Select +/PU/PD: Value F10: Save ESC: Exit F1: General Help
F5: Previous Value F6: Fail-Safe Defaults F7: Optimized Defaults

- Press <Esc> to return to the main menu.
- Select "**Save & Exit Setup**" and press <Enter>. Type <Y> and press <Enter>.
- Install Windows 98 by typing the following parameter. This is to ensure that the ACPI function is supported. There is a space between the P and the J.

[drive]:>setup /p j

If you have previously installed Windows 98, you need to upgrade the system in order to support ACPI. Please contact Microsoft for upgrade information.

- Boot Windows 98. In the Windows 98 desktop, click the Start button. Move the cursor to Setting, then click Control Panel. To check whether ACPI was properly installed, double-click the System icon. In the System Properties dialog box, click the "**Device Manager**" tab. In "**View devices by type**", click "**System devices**".

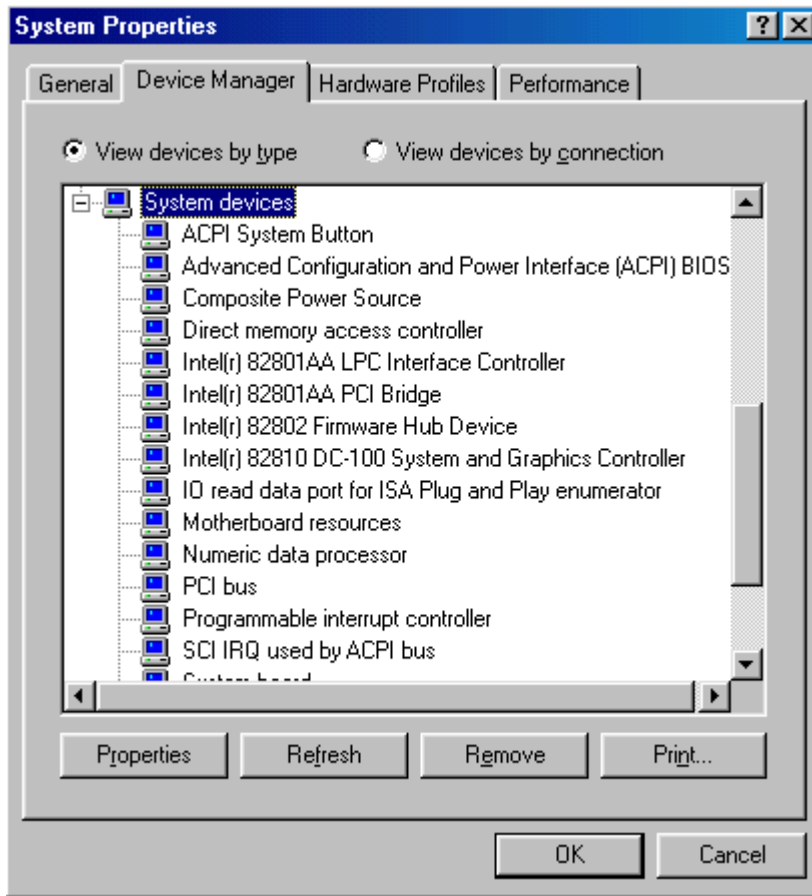

8. Double-click the System icon. In the System Properties dialog box, click the **Performance** tab.



- Click File System. In the "Typical role of this computer" field, select "Mobile or docking system". Click **Apply**, then click **OK**. Restart the computer.

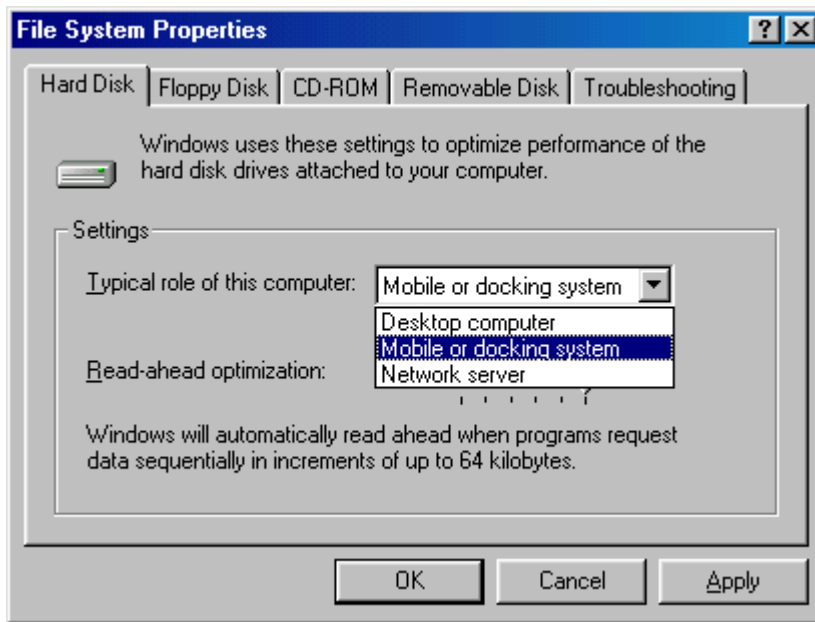

- Repeat step 7 to open the **Control Panel** dialog box. Double-click the **Power Management icon**.
- Click the **Advanced** tab. In the "When I press the power button on my computer" field, select "Standby".

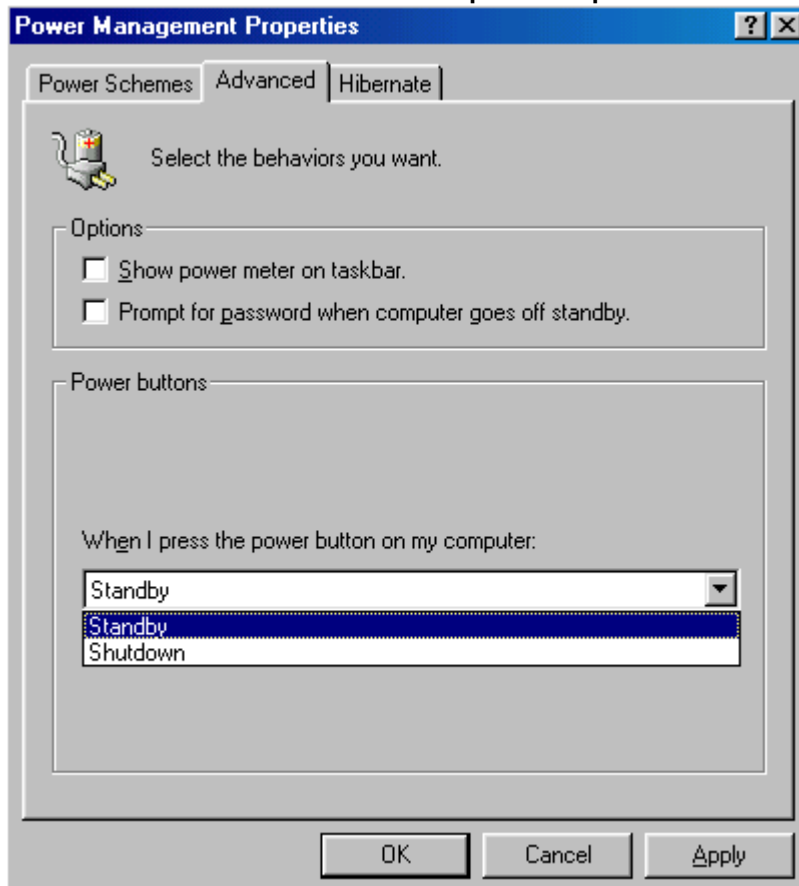

- After completing the steps above and you want to power-off the computer, you do not need to go through the process of closing files, applications and operation system. You can power off the computer at once by pressing the power button or selecting "Standby" when you shut down Windows 98.

To power-on the computer, just press the power button. The operating session where you left off when you power-off the computer will resume in not more than 8 seconds. However, the power button will not function if a keyboard password has been set in the "KB Power On Password" field of the Integrated Peripherals submenu. You must type the password to power-on the computer.

If you have changed the color or resolution (in the Display Properties dialog box), do not apply the settings without restarting. You must restart the computer.

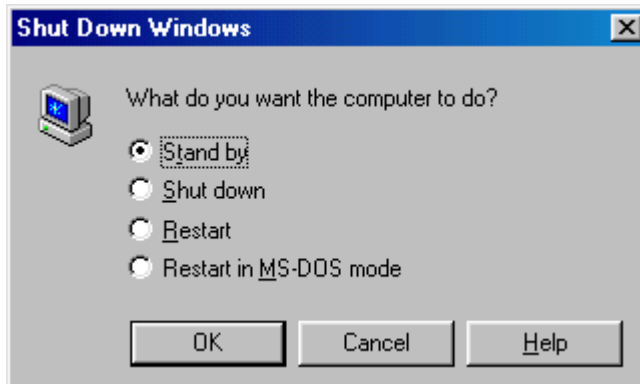

CE TEST REPORT

Declaration No. :C9O1301 October 29, 1999

The following designated product

**EQUIPMENT : MAIN BOARD
MODEL NO. : P3WMA**

The measurements shown in this test report were made in accordance with the procedures given in EUROPEAN COUNCIL DIRECTIVE 89/336/EEC.

The equipment was passed the test performed according to European Standard EN 55022:1994/A1:1995/A2:1997 Class B and EN 50 082-1:1997 EN 61 000-4-2:1995, EN 61 000-4-3:1996, EN 61 000-4-4:1995



NSTL

NSTL " Year 2000 Test " Certification Letter

August 27, 1999

Testing Date : August 27, 1999

Certification Date : August 27, 1999

Certification Number : NCY2000-990827-016

P3WMA system has passed NSTL Year 2000 certification test program. The Year 2000 test program tests a personal computer for its ability to support the year 2000.

The Year 2000 certification test has been done under the following system configuration:

System Model Name :	P3WMA
Hardware Revision :	B
CPU Model :	Intel Pentium II 333/66 MHz
On Board Memory / L2 Cache :	PC100 SDRAM DIMM 64MBx1 / 128KB
System BIOS :	Award Modular BIOS v6.00PG, P3WMA VER:1.0 06/23/1999-i810-W83627HF- 6A69MTP9C-00
RTC Brand Name :	Intel
RTC Model Name :	FW82801AA