

Declaration of Conformity



QUANTUM DESIGNS(HK) LTD.
20th Floor, Devon House, Taikoo Place, 979 King's Road,
Quarry Bay, Hong Kong

declares that the product

Mainboard
PlatiniX 2D

is in conformity with

(reference to the specification under which conformity is declared in
accordance with 89/336 EEC-EMC Directive)

- EN 55022 Limits and methods of measurements of radio disturbance characteristics of information technology equipment
- EN 50081-1 Generic emission standard Part 1:
Residential, commercial and light industry
- EN 50082-1 Generic immunity standard Part 1:
Residential, commercial and light industry

European Representative:

QDI COMPUTER(UK) LTD.

QDI SYSTEM HANDEL GMBH

QDI COMPUTER(FRANCE) SARL

LEGEND QDI SPAIN S.L.

QDI COMPUTER(SCANDINAVIA)A/S

QDI EUROPE B.V

QDI COMPUTER HANDELS GMBH

QDI COMPUTER(SWEDEN)AB

Signature : Xu Wenge Place / Date : HONG KONG/2001

Printed Name : Xu Wenge Position/ Title : Assistant President

Declaration of Conformity



Trade Name: QDI Computer (U . S . A .) Inc.
Model Name: [PlatiniX 2D](#)
Responsible Party: QDI Computer (U . S . A .) Inc.
Address: 41456 Christy Street
Fremont, CA 94538
Telephone: (510) 668-4933
Facsimile: (510) 668-4966

Equipment Classification: FCC Class B Subassembly
Type of Product: Motherboard
Manufacturer: Quantum Designs (HK) Inc.
Address: 20th Floor, Devon House, Taikoo Place
979 King's Road, Quarry Bay, HONG
KONG

Supplementary Information:

This device complies with Part 15 of the FCC Rules. Operation is subject to the following two conditions : (1) this device may not cause harmful interference, and (2) this device must accept any interference received, including interference that may cause undesired operation.

Tested to comply with FCC standards.

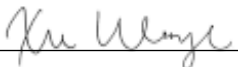
Signature : 

Date : 2001

CONTENTS



1. Introduction	1
Overview	1
Key Features	1
2. Installation Instructions	4
External Connectors	4
PS/2 Keyboard /Mouse Connector	4
USB1, USB2 and LAN Connectors	4
Parallel Port, Serial Port Connectors.....	5
Line-in jack, Mic-in jack, Speaker-out jack and MIDI/Joystick Connector.....	5
Chassis Security Switch(CHSSSEC).....	5
ATX 12V Power Supply Connectors & Power Switch	6
Hard Disk LED Connector (HD_LED)	6
Reset Switch (RESET)	6
Speaker Connector (SPEAKER)	7
Power LED Connector(PWR_LED)	7
Green LED Connector(GREEN_LED)	7
ACPI LED Connector(ACPI_LED)	7
Hardware Green Connector (SLEEP SW)	7
Key Lock Connector(KEYLK)	7
USB3, 4 Connector	8
Infrared Header (IrDA)	8
Sound Connector(PC-PCI)	8
Fan Connectors(CPUFAN, CHSFAN, PWRFAN)	9
Intruder Detect Switch(JINTR).....	9
Wake-Up On LAN (WOL)	10
Wake-Up On Internal Modem (WOM).....	10
Audio Connectors (AUXIN, CD_IN, MODEM).....	11
4-pin SMBus Connector(SMBUS).....	11
Diagnosis LED	12
Communication and Networking Riser Slot(CNR).....	12
Audio Interface.....	13
Main Expqnsion slot and Connectors.....	13
Jumper Settings.....	14
BIOS-Protection Jumper(JAV).....	14
Overclocking Jumper Setting(JFS0,JFS1).....	15

CONTENTS



Clear CMOS(JCC).....	16
CPU Core Voltage Setting(JVID0~4).....	16
Enable Front/Back Panel USB Device	
Wake-up Function(JUSB, JFUSB).....	18
Enable/Disable onboard Audio(JSD).....	18
Enable keyboard password power-on function(JKB).....	19

3. BIOS Description.....20

Utility Support.....20

AWDFLASH.EXE	20
--------------------	----

AWARD BIOS Description.....21

Entering Setup	21
Load Optimized Defaults	21
Standard CMOS Features Setup.....	21
CPU SpeedEasyII Setup.....	25
Advanced BIOS Features Setup.....	26
Advanced Chipset Features Setup.....	28
Power Management Setup.....	30
PnP/PCI Configurations Setup.....	33
Integrated Peripherals.....	34
PC Health Status.....	37
Password Setting.....	39
Boot with BIOS defaults.....	39

Appendix.....40

QDI Driver CD.....	40
ManageEasy.....	41
BIOS-ProtectEasy.....	41
Norton AntiVirus.....	41
LogoEasyII.....	42
BootEasy.....	43
RecoveryEasy.....	46
StepEasyII.....	54
SpeedEasyII.....	56
Platinix2D(French).....	58
Platinix2D(Spanish).....	62
Layout	



Chapter 1

Introduction

Overview

PlatiniX 2D series of mainboards utilize Intel®845DDR chipset consisting of two components: the Intel®i845DDR Memory Controller Hub(Brookdale MCH) and the 82801BA I/O Controller Hub2(ICH2), providing a fully compatible, high performance and cost-effective PC/ATX platform. The new integrated technologies, together with AGP 4X support, AC'97 audio, integrated LAN(optional), 4 USB ports, and ATA66/100/33, give customers an advanced, multimedia solution at reasonable price. It provides 400MHz host bus speed to support Intel® Pentium 4 socket 478 processors and the largest DDR memory capacity is up to 2GB. It also provides advanced features such as Wake up by USB devices, Wake-on-LAN, Wake-on-Modem, ACPI and Keyboard Password Power-on functions. Suspend to RAM, the optimal implementation of the Advanced Configuration and Power Interface (ACPI) specification, makes the PC's power consumption drop to the lowest possible level and enable quick wakeup. BootEasy, QDI innovation, lets the PC boot freely and rapidly. StepEasyII, our new innovation is also supplied to enable you to adjust CPU frequency step by step easily to utilize CPU's potential ability.

Key Features

Form factor

- ATX form factor of 305mm x 224mm

Microprocessor

- Supports Intel®Pentium 4 (Willamette) socket 478 processors at 1.4/1.5/1.6/1.7/1.8/1.9 2.0GHz and above
- Supports Intel®Pentium 4 (Northwood) socket 478 processors at 2.0/2.2GHz and above
- Supports 400MHz host bus speed

System memory

- Provides two 184-pin DDR SDRAM interfaces
- Supports DDR200/DDR266 SDRAM
- Supports 64/128/256/512Mb technology up to 2GB

Onboard IDE

- Supports Independent timing of up to 4 drives
- Supports Ultra ATA 33/66/100, PIO mode
- Two fast IDE interfaces supporting four IDE devices including IDE hard disks and CD ROM drives



Onboard LAN (available on PlatiniX 2D-L/-AL, PlatiniX 2DI-L/-AL)

- 10/100 Mbit/sec Ethernet support
- 10/100M LAN interface built-in on board

4 USB

- USB 1.1 compliant
- Supports wake-up from S1 (power on suspend), S3(depends on device)

Onboard I/O

- One floppy port supporting up to two 3.5" or 5.25" floppy drives with 360K/720K/1.2M/1.44M/2.88M format
- Two high speed 16550 compatible UART (COM1/COM2/COM3/COM4 selective) with 16 byte send/receive FIFO
- One parallel port supports SPP/EPP/ECP mode
- Infrared interface
- All I/O ports can be enabled/disabled in the BIOS setup

Onboard Audio(available on PlatiniX 2D-A/-AL, PlatiniX 2DI-A/-AL)

- AC'97 2.1 Specification Compliant
- 16bit stereo codec
- Multiple stereo input mixer
- Mono and stereo volume control
- Provides onboard Line-in Jack, Microphone-in Jack, Speaker-out Jack with onboard amplifier and MIDI/Joystick Connector

AGP Interface

- AGP Connector supports AGP 2.0 including AGP 4x data transfers

Advanced features

- PCI 2.2 Specification Compliant
- Provides Trend ChipAwayVirus On Guard
- Supports Windows 98/2000/ME soft-off
- Supports Wake-on-LAN and Wake-on-Modem
- Supports Keyboard Password Power-on function
- Supports system monitoring(monitors CPU and system temperatures, system voltages, fan speed)
- Providing QDI innovations: RecoveryEasy, BIOS-ProtectEasy, LogoEasyII, ManageEasy(optional), BootEasy, StepEasyII, SpeedEasyII.



BIOS

- Licensed advanced AWARD(Phoenix) BIOS, supports flash ROM, plug and play ready
- Supports IDE CDRROM/SCSI boot up

Green function

- Supports ACPI (Advanced Configuration and Power Interface) and ODPM (OS Directed Power Management)
- Supports ACPI power status: S0 (full-on), S1 (power on suspend), S3 (suspend to RAM), S4(suspend to Disk,depends on OS) and S5 (soft-off)

New Feature

- **CPU,AGP,DDR Voltage adjusting function**

Adjusting CPU core voltage in BIOS to improve system stability and overclocking ability.

Adjusting AGP voltage in BIOS to improve system stability and overclock ability.

Adjusting DDR voltage in BIOS to improve system stability and overclock ability.

- **Diagnosis LED**

The mainboard provides Diagnosis LED function to indicate CPU, chipset, memory, PCI device, clockgen and Video status during system booting up. This function may make maintenance of your computer more convenient and simple. During POST, if CPU is burned out or the BIOS chip is damaged or CPU is absent, LED1 will blink at a frequency of 1Hz, when the POST comes to CPU checking and chipset initializing, memory testing, PCI detecting, clockgen initializing and Video initializing, the LEDs will light up in turn. When the POST finishes all the 5 LEDs will turn off. Otherwise the corresponding LED will remain light up to indicate a problem occurs.

- **Power supply flexibility**

Users are strongly recommended to use an ATX12V power supply. However, the PlatiniX 2D mainboard can also work with a legacy ATX power supply as long as its +12V rail can deliver enough current(at least 8 Amperes).

NOTE: System stability with an ATX power supply is not guaranteed here and we are not responsible for any damage caused.

-- This page is intentionally left blank --



Chapter 2

Installation Instructions

This section covers External Connectors and Jumper Settings. Refer to the mainboard layout chart for locations of all jumpers, external connectors, slots and I/O ports. Furthermore, this section lists all necessary connector pin assignments for your reference. The particular state of the jumpers, connectors and ports are illustrated in the following figures. Before setting the jumpers or inserting these connectors, please pay attention to the direction.

External Connectors

PS/2 Keyboard/Mouse Connector

PS/2 keyboard connector is for the usage of PS/2 keyboard. If using a standard AT size keyboard, an adapter should be used to fit this connector. PS/2 mouse connector is for the usage of PS/2 mouse.



USB1, USB2 and LAN Connectors

(LAN connector is only available on PlatiniX 2D-L/-AL, PlatiniX 2DI-L/-AL)

Two USB ports are for connecting USB devices. The RJ-45 connector is for onboard LAN.

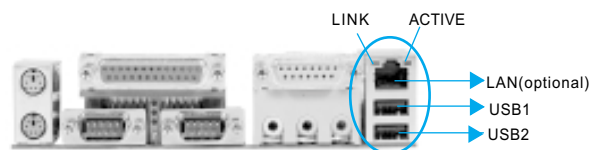

Be sure to unplug the AC power supply before adding or removing expansion cards or other system peripherals, otherwise your mainboard and expansion cards might be seriously damaged.



Parallel Port, Serial Port Connectors (UART1, UART2)

The parallel port connector can be connected to a parallel device such as a printer. The serial port UART1,2 connectors can be connected to a serial port device such as a serial port mouse. You can enable/disable them and choose the IRQ or I/O address in "Integrated Peripherals" from AWARD CMOS SETUP.

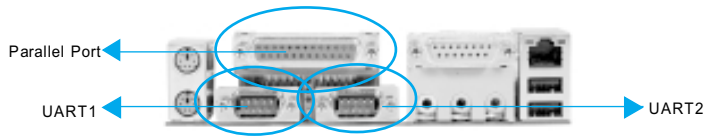

Line-in jack, Microphone-in jack, Speaker-out jack and MIDI/Joystick Connector (available on PlatiniX 2D-A/-AL, PlatiniX 2DI-A/-AL)

The Line-in jack can be connected to devices such as a cassette player or minidisc player to playback or record. The Microphone-in jack can be connected to a microphone for voice input. The Speaker-out jack allows you to connect speakers or headphones for audio output from the internal amplifier. The MIDI/Joystick connector allows you to connect a game joystick or a MIDI device.

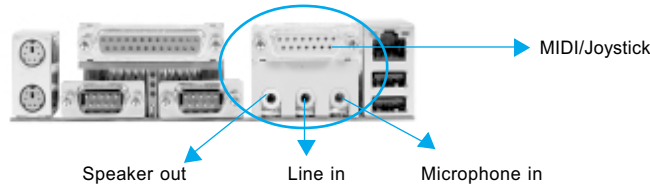

Chassis Security Switch (CHSSEC)

The connector connects to the chassis security switch on the case. The system can detect the chassis intrusion through the status of this connector. If the connector has been closed once, the system will record the status and indicate the chassis has been opened. You can monitor or check this information from QDI ManageEasy(optional) software.

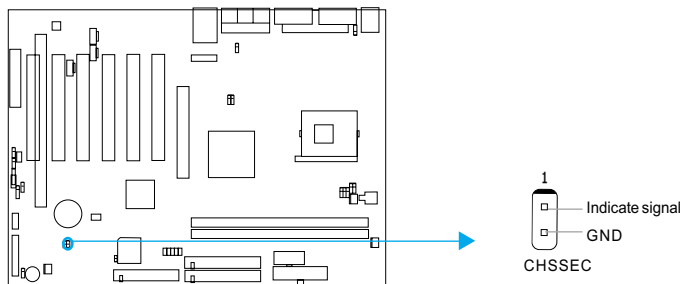



ATX12V Power Supply Connectors & Power Switch (POWER SW)

The PlatiniX 2D series mainboards prefer an ATX12V power supply. Be sure to connect the ATX 12V power supply plugs to the connectors in their proper orientation. The difference between ATX12V power supply and ATX power supply is that ATX12V power supply provides two additional power connectors: AUX power connector and +12V power connector. However, the PlatiniX 2D series mainboard provide a unique design especially for those who still use legacy ATX power supply (without AUX and +12V connector) as long as their ATX power supplies can provide enough current on +12V rail (at least 8 Amperes). System stability with an ATX power supply is not guaranteed and we are not responsible for any damage caused.

The power switch (POWER SW) should be connected to a momentary switch. When powering up your system, first turn on the mechanical switch of the power supply (if one is provided), then push once the power switch. When powering off the system, you needn't turn off the mechanical switch, just ***Push once*** the power switch.

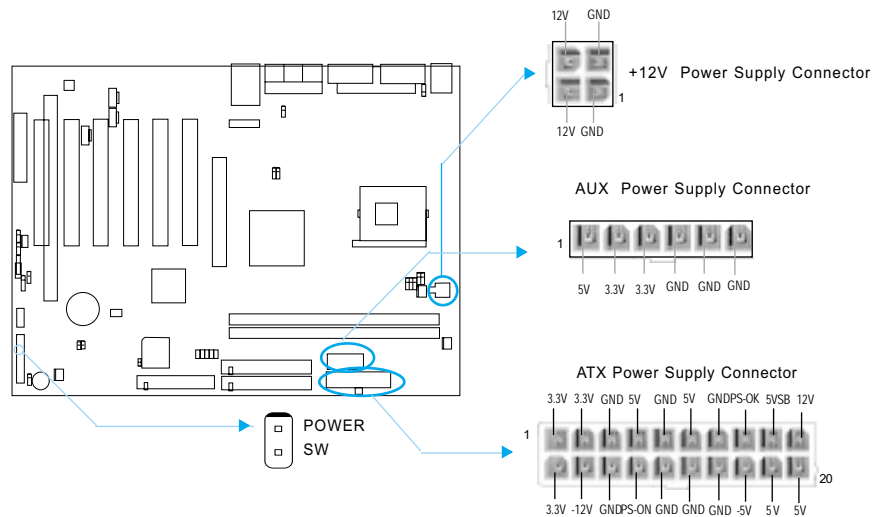

Note: * If you change “soft-off by PWR-BTTN” from default “Instant-off” to “Delay 4 Sec” in the “POWER MANAGEMENT SETUP” section of the CMOS SETUP, the power button should be pressed for more than 4 seconds before the system powers down.

Hard Disk LED Connector (HD_LED)

The connector connects to the case's IDE indicator LED indicating the activity status of IDE hard disk. The connector has an orientation. If one way doesn't work, try the other way.

Reset Switch (RESET)

The connector connects to the case's reset switch. Press the switch once, the system resets.



Speaker Connector (SPEAKER)

The connector can be connected to the speaker on the case.

Power LED Connector (PWR_LED)

When the system is in S0 status, the LED is on. When the system is in S1 status, the LED is blink; When the system is in S3,S4, S5 status, the LED is off. The connector has an orientation.

GREEN LED Connector (GREEN_LED)

When the system is in S0,S1,S4 ,S5 status, the LED is off,When the system is in S3 status, the LED is on.

ACPI LED Connector (ACPI_LED)

The ACPI LED is a dual-color light with three pins. Pin1 and Pin2 drive different color lights. If Pin1 drives the orange light , then, Pin2 drives the green light, the following status will come out. When the system is in S0 status, the LED is green on. When the system is in S1 status, the LED is green blink. When the system is in S3 status, the LED is orange on. When the system is in S4, S5 status, the LED is off.

Hardware Green Connector (SLEEP_SW)

Push once the switch connected to this header, the system enters suspend mode.

Key Lock Connector (KEYLK)

The connector can be connected to the keyboard lock switch on the case for locking the keyboard.

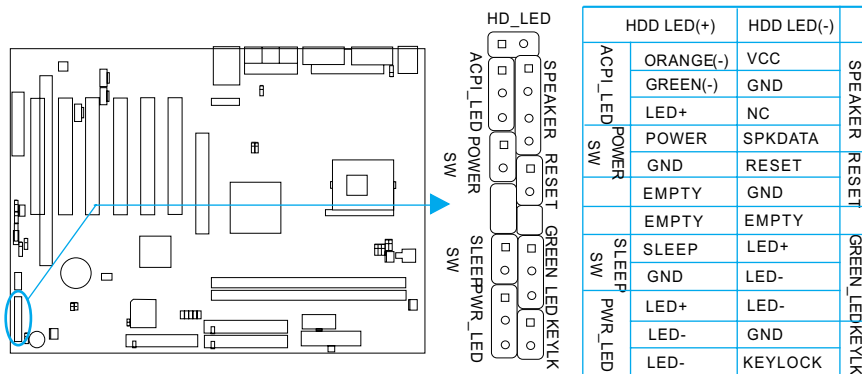



USB3,4 Connector

Besides USB1,2 on the back panel, PlatiniX 2D series of mainboards also have a 10-pin header on board which may connect to front panel USB cable(optional) to provide additional two USB ports.

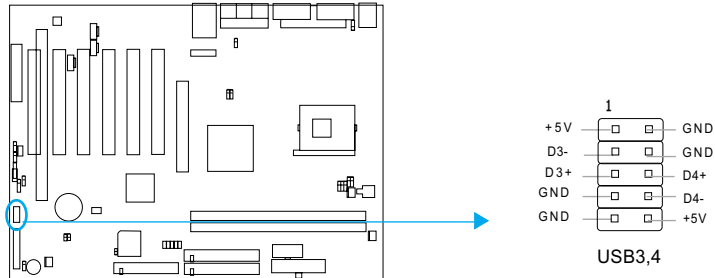

Infrared Header (IrDA)

This connector supports wireless transmitting and receiving device. Before using this function, configure the settings for IR Address, IR Mode and IR IRQ from the "INTEGRATED PERIPHERALS" section of the CMOS SETUP.

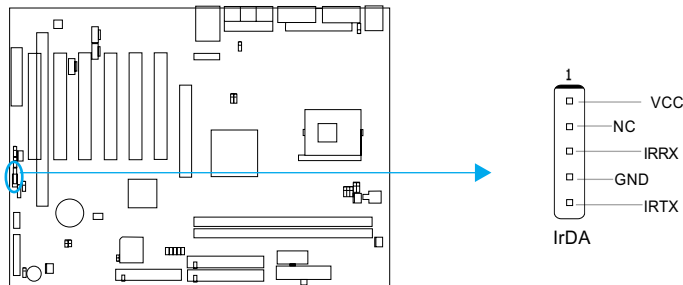

Sound Connector (PC-PCI)

This connector provides a bridge between the mainboard and PCI sound card to deliver sound compatibility under DOS real-mode environment.

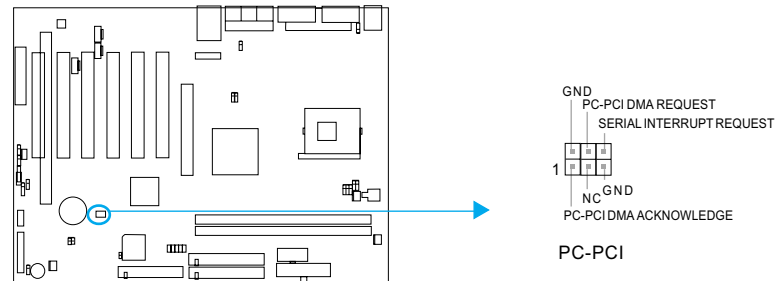



Fan Connectors (PWRFAN, CPUFAN, CHSFAN)

The fan speed of these three fans can be detected and viewed in "PC Health" section of the CMOS SETUP. These three fans will be automatically turned off after the system enters suspend mode.

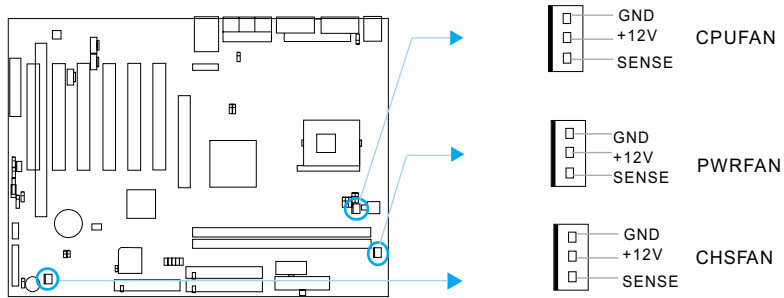

Intruder Detect Switch(JINTR)(Reserved)

The connector connects to the chassis security switch on the case. The system can detect the chassis intrusion through the status of this connector. If the connector has been closed once, the system will send a message over the network to alert the network manager through the on board LAN controller within ICH2.

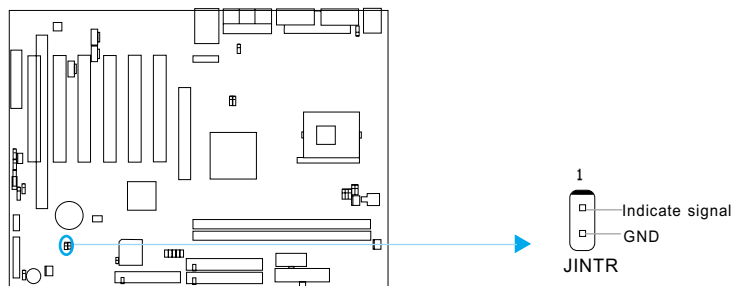



Wake-Up On LAN (WOL)

Through the Wake-Up On LAN function, a wake event occurring from the network can wake up the system. If this function is to be used, please be sure an ATX12V power supply of which 5VSB line is capable of delivering current at least 720mA, and a LAN adapter which supports this function is used. Then connect this header to the relevant connector on the LAN adapter, set "Wake-Up by Ring/LAN" as Enabled in the "POWER MANAGEMENT SETUP" section of the CMOS SETUP. Save and exit, then boot the operating system once to make sure this function takes effect.

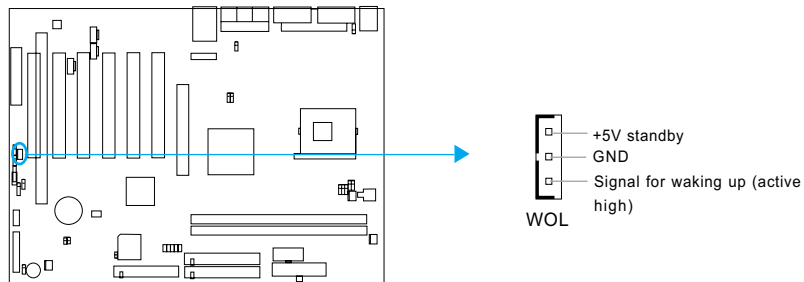

Wake-Up On Internal Modem (WOM)

Through this function, the system which is in the suspend or soft-off status can be waked up by a ring signal received from the internal modem. When this function is used, be sure an internal modem card which supports this function is used. Then connect this header to the relevant connector on the modem card, set "Wake-Up by Ring/LAN" as Enabled in the "Power Management Setup" section of the CMOS SETUP. Save and exit, then boot the operating system once to make sure this function takes effect.

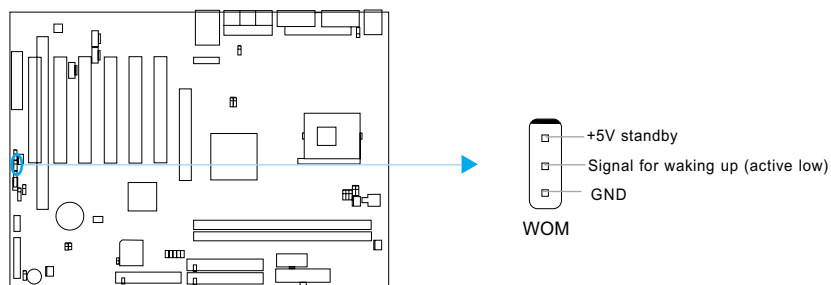



Audio Connectors (CD_IN, MODEM, AUXIN)

(Available on PlatiniX 2D-A/-AL, PlatiniX 2DI-A/-AL)

CD_IN is a Sony standard CD audio connector, it can be connected to a CD-ROM drive through a CD audio cable. The MODEM connector allows the onboard audio to interface with a voice modem card with a similar connector. It allows connecting the mono_in (such as a phone) or mono_out (such as a speaker) between the onboard audio and the voice modem card. AUXIN allows you to receive stereo audio input from sound sources such as a TV tuner, or MPEG card.

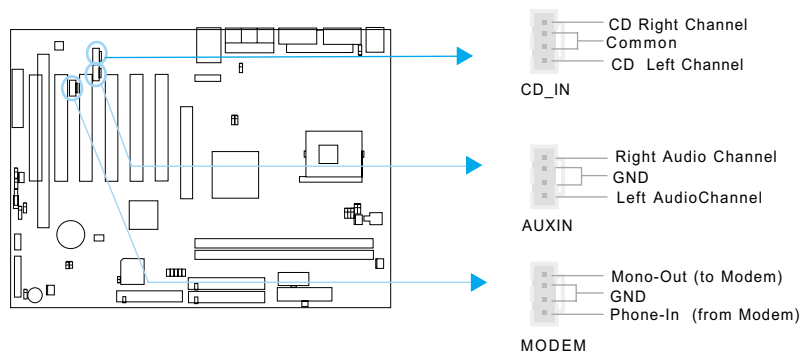

4-pin SMBus Connector(SMBUS)

This connector allows you to connect SMBus devices. SMBus devices communicate through the SMBus with a SMBus host and/or other SMBus devices. The SMBus or System Management Bus is a specific implementation of I²C bus, which is a multi-master bus, that is, multiple devices can be connected to the same bus and each one can act as a master by initiating data transfer.

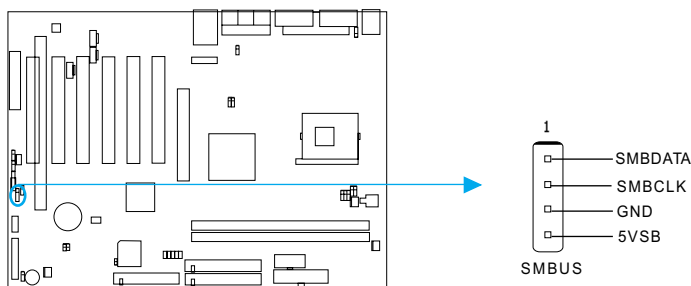



Diagnosis LED

During the POST, the LED1~LED5 representing POST steps will light up in turn, please refer to the following table to learn the POST status:

LED1	LED2	LED3	LED4	LED5	status
blink	off	off	off	off	CPU damaged , BIOS chip absent or damaged
on	off	off	off	off	system detect CPU and initialize chipset
off	on	off	off	off	system detect memory
off	off	on	off	off	system initialize PCI
off	off	off	on	off	system initialize clockgen
off	off	off	off	on	system detect Video and invokeVideoBIOS

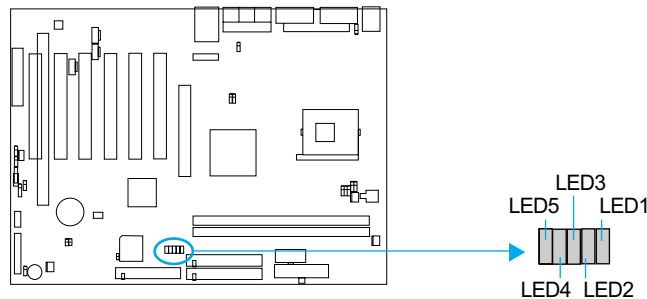

Communication and Networking Riser Slot(CNR)

The mainboard provides Communication and Networking Riser(CNR) interface which can support audio and/or modem functions . Furthermore, it provides a LAN interface for networking functions. What its superiority compared with AMR is being able to support plug-and-play function. Mechanically the CNR shares a PCI slot, thus if a CNR card is not used,users can an additional PCI slot which shares the same position on back panel with CNR.

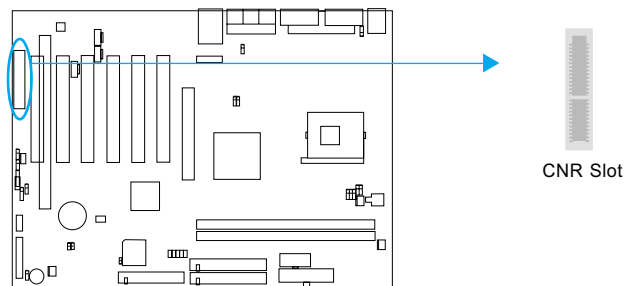

By using an audio codec, the AC'97 digital link on CNR provides for cost-effective, high-quality, integrated audio on the platform. AC'97 digital link also allows several external codecs to be connected to the ICH2. The digital link can be expanded to support two or three audio codecs for up to 6 channels of PCM audio output (full AC-3 decode) or a combination of an audio and modem codec.



Audio Interface-BLSPK(Reserved)

The audio interface provides three kinds of audio output choices: the FrontAudio, the RearAudio and the ActiveAudio. Their priority level is as sequence. When the FrontAudio is available, the RearAudio and the ActiveAudio(in-case speakers) will be cut off. When the RearAudio is available, the ActiveAudio will be cut off. An onboard amplifier is provided for the earphone. When the FrontAudio is absent, Pin11 and Pin12, Pin13 and Pin14 must be short connected.

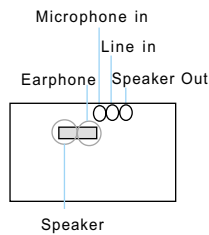

Pin No.	Symbol	Pin No.	Symbol
1	Active LINE Out(R)	2	Active LINE Out(L)
3	GND (ALO)	4	GND (ALO)
5	GND(+12)	6	GND(+12)
7	+12V(1A)	8	(Cut away)
9	MIC	10	GND (MIC)
11	Front LINE Out(R)	12	LINE Next(R)
13	Front LINE Out(L)	14	LINE Next(L)
15	GND (FLO)	16	(Cut away)

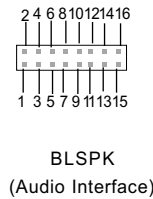
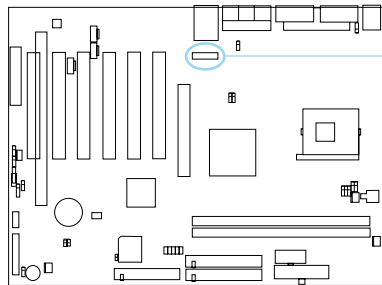
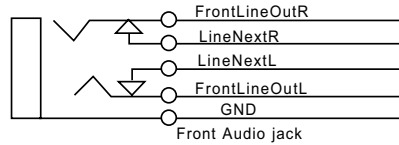









Main Expansion Slots and Connectors

Slot/Port (Quantity)	Description
IDE(2)	IDE ports
FLOPPY(1)	Floppy drive port
DDR(2)	DDR SDRAM slots
USB(4)	USB connectors
AGP(1)	AGP slot
IrDA(1)	IrDA connector
CNR(1)	CNR slot
PCI(5+1(optional))	PCI slots
ISA(1)(optional)	ISA slot
LAN(1)(optional)	LAN connector
MIDI/Joystick(optional)	MIDI/Joystick connector



Jumper Settings

Jumpers are located on the mainboard, they are, clear CMOS jumper JCC, enable keyboard password power-on function jumper JKB, and enable/disable onboard audio jumper JSD etc. Pin 1 for all jumpers are located on the side with a thick white line (Pin1→ , referring to the mainboard's silkscreen. Jumpers with three pins will be shown as  to represent pin1 & pin2 ("1-2") closed and  to represent pin2 & pin3 ("2-3") closed.

Jumper	Symbol	Description	Represent
		1-2	set pin1 and pin2 closed
		2-3	set pin2 and pin3 closed
		close	set the pins closed
		open	set the pins opened

BIOS-Protection Jumper (JAV)

The BIOS of the mainboard is inside the FWH. If the jumper JAV is set as closed, the system BIOS is protected from being attacked by serious virus such as CIH virus, you will be unable to flash the BIOS to the mainboard. However in this status .

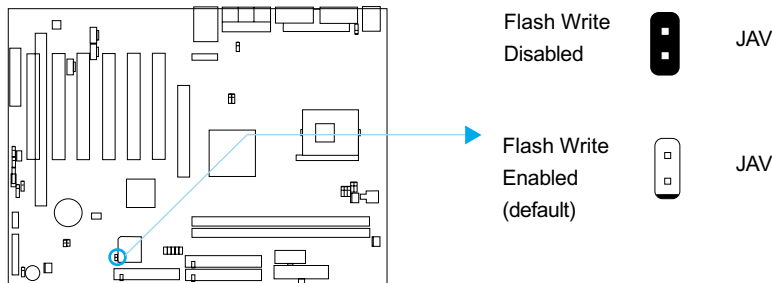

Setting the jumper JAV as open(default), meanwhile disabling the "Flash Write Protect" item from "Advanced BIOS Features" in AWARD BIOS CMOS Setup, allows you to flash the BIOS to the Flash ROM.

The DMI (Desktop Management Interface) system information such as the CPU type/speed, memory size, and expansion cards will be detected by the onboard BIOS and stored in the flash ROM. Whenever the system hardware configuration is changed, DMI information will be updated automatically. However, setting jumper JAV as closed makes flashing BIOS and updating DMI information impossible. Therefore, set JAV as open when changing the system hardware configuration, or the error message "Unknown Flash Type" will be displayed on the screen, and DMI information may not be updated.

Under special conditions, the jumper "JAV" should be set as OPEN. For further details, refer to the "BootEasy" part of appendix.



Overclocking Jumper Setting (JFS0,JFS1)(optional)

Jumpers JFS0 and JFS1 provides users with CPU overclocking feature. The host bus speed can be set as 66x4/100x4/133x4/200x4MHz or AUTO. If CPU FSB(front side bus) is set as auto, the system detects the CPU FSB automatically. The table below is for your reference.

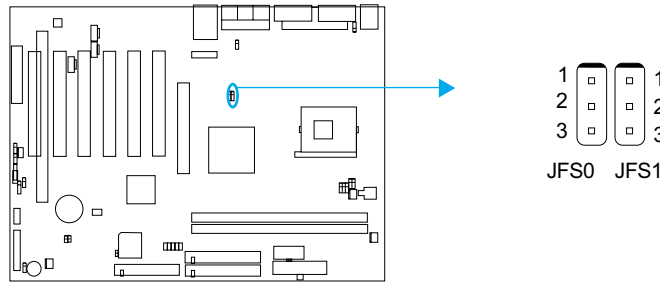

CPUFSB	AUTO	66x4MHz	100x4MHz	133x4MHz	200x4MHz
JFS0	1-2 (default)	2-3	1-2	OPEN	2-3
JFS1	1-2 (default)	2-3	2-3	OPEN	OPEN

“1-2”: pin1 & pin2 closed

“2-3”: pin2 & pin3 closed

Whether or not your system can be overclocked depends on your processor’s and memory’s capability. Whether the processor is bus ratio locked or unlocked should also be taken into account. For bus ratio unlocked processor, this overclocking feature can be implemented by setting FSB as 66x4/100x4/133x4/200x4MHz, meanwhile adjusting the bus ratio (multiplier) in “CPU SpeedEasyII Setup” in AWARD BIOS CMOS Setup and memory. You can also adjust the CPU frequency by running StepEasyII. We do not guarantee the stability of the overclocking system.

Warning: Be sure your selection is right. CPU over speeding is dangerous! We will not be responsible for any damages caused.



Clear CMOS (JCC)

If you want to clear CMOS, unplug the AC power supply first, close JCC (pin1 & pin2) once, set JCC back to the normal status with pin2 & pin3 connected, then power on the system.

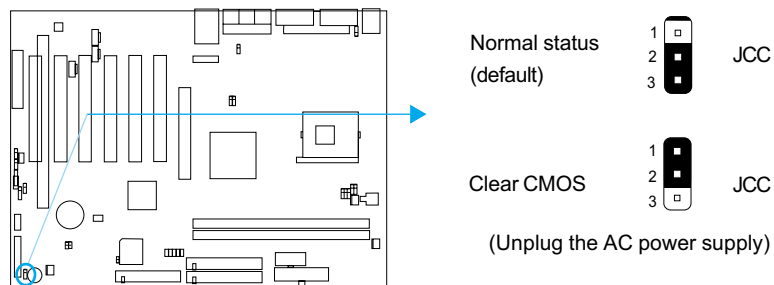

CPU Core Voltage Setting (JVID0~4)(Reserved)

The Jumpers JVID0~4 allow you to adjust the CPU Core Voltage Manually to improve the CPU overclocking ability. But, we strongly recommend you not to adjust it unless you are an expert on this. If the jumpers are set as Auto, the system will detect the CPU core voltage automatically.

“Auto”: pin1 and pin2 of JVID0, JVID1, JVID2, JVID3 and JVID4 closed(default);

“0”: pin2 and pin3 closed;

“1”: pin1, pin2 and pin3 opened.

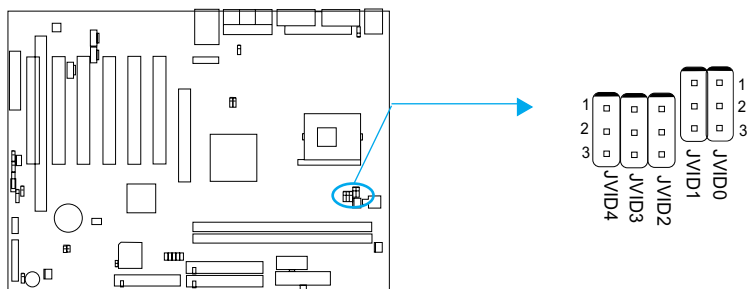



JVID4	JVID3	JVID2	JVID1	JVID0	Vcore(V)
1	1	1	1	1	Output Off
1	1	1	1	0	1.1
1	1	1	0	1	1.125
1	1	1	0	0	1.15
1	1	0	1	1	1.175
1	1	0	1	0	1.2
1	1	0	0	1	1.225
1	1	0	0	0	1.25
1	0	1	1	1	1.275
1	0	1	1	0	1.3
1	0	1	0	1	1.325
1	0	1	0	0	1.35
1	0	0	1	1	1.375
1	0	0	1	0	1.4
1	0	0	0	1	1.425
1	0	0	0	0	1.45
0	1	1	1	1	1.475
0	1	1	1	0	1.5
0	1	1	0	1	1.525
0	1	1	0	0	1.55
0	1	0	1	1	1.575
0	1	0	1	0	1.6
0	1	0	0	1	1.625
0	1	0	0	0	1.65
0	0	1	1	1	1.675
0	0	1	1	0	1.7
0	0	1	0	1	1.725
0	0	1	0	0	1.75
0	0	0	1	1	1.775
0	0	0	1	0	1.8
0	0	0	0	1	1.825
0	0	0	0	0	1.85

Warning: To set CPU core voltage higher than its default core voltage is not suggested. If you do, we will not be responsible for any damages caused.



Enable Front/Back Panel USB Device Wake-up Function (JFUSB/JUSB)

The mainboard provides the advanced USB device wake-up function. The system can be waked up from its power saving status including ACPI S3 by activating USB device. Before using this function, set JFUSB/JUSB with pin1 & pin2 closed. Otherwise, set JFUSB/JUSB with pin2 & pin3 closed for disabling. Furthermore, the item "Wake-Up From S3 by USB" in CMOS Setup should also be set correspondingly to enable or disable this function.

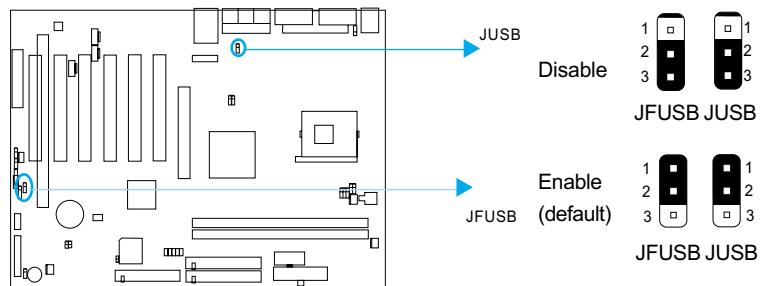

Enable/Disable onboard audio (JSD)

(Available on PlatiniX 2D-A/-AL, PlatiniX 2DI-A/-AL)

If you want to use the on-board audio, set JSD with pin2 & pin3 closed. Otherwise, set JSD with pin1 & pin2 closed for disabling this function.

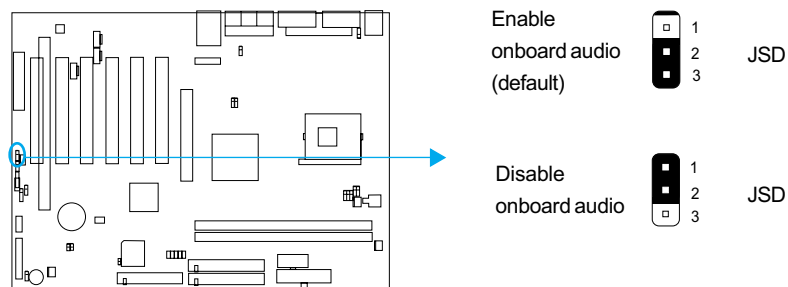



Enable keyboard password power-on function (JKB)

The mainboard provides the advanced keyboard password power-on function. Before using this function, set JKB with pin1 & pin2 closed. Otherwise, set JKB with pin2 & pin3 closed for disabling.

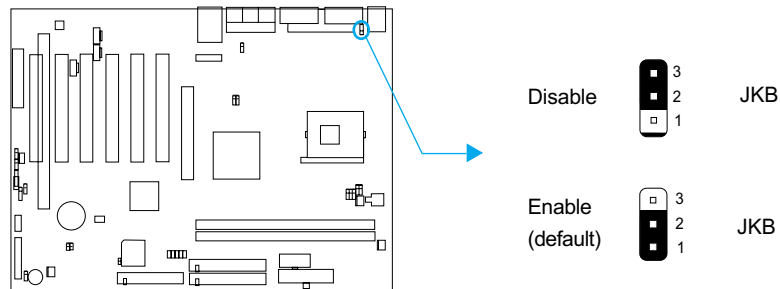

Furthermore in order to implement this function, set “POWER ON Function” to “Password” and enter the keyboard power-on password in the “INTEGRATED PERIPHERALS” section of the CMOS SETUP. Save and exit, then power off your system. In this case, the power button’s power-on function is disabled.

Note:

1. If using this function, 5VSB line of the power supply should be capable of delivering enough current for all the devices connected to the keyboard port, if not, you will be unable to power up the system using the keyboard.
2. If you set JKB with pin2 & pin3 closed, set “POWER ON Function” to BUTTON ONLY, don’t set it to Password, or you’ll be unable to power up your system by the keyboard or the power button.
3. If you encounter the above problems, clear CMOS and set the jumper pin2 and pin3 closed to disable the function, then power on the system by pushing the power button, and set “power on Function” back to “Button Only”.

-- This page is intentionally left blank --



Chapter 3

BIOS Description

Utility Support:

AWDFLASH.EXE

This is a flash memory write/read utility used for the purpose of upgrading your BIOS when necessary. Before doing so, please note:

- **We strongly recommend you only upgrade BIOS when encounter problems.**
- **Before upgrading your BIOS, review the description below to avoid making mistakes, destroying the BIOS and resulting in a non-working system.**

When you encounter problems, for example, you find your system does not support the latest CPU released after our current mainboard, you may therefore upgrade the BIOS, please don't forget to set JAV as open and disable the "Flash Write Protect" item in AWARD BIOS CMOS Setup first .

Follow the steps exactly for a successful upgrade.

1. Create a bootable system floppy diskette by typing Format A:/s from the DOS prompt under DOS6.xx or Windows 9x environment.
2. Copy AWDFLASH.EXE(version>=7.95) from the directory \Utility located on QDI Driver CD to your new bootable diskette.
3. Download the updated BIOS file from the Website (<http://www.qdigrp.com>). Please be sure to download the suitable BIOS file for your motherboard.
4. Decompress the file download, copy the BIOS file (xx.bin) to the bootable diskette, and note the checksum of this BIOS which is located in readme file.
5. Reboot the system from the bootable diskette created.
6. Then run the AWDFLASH utility at the A:\ prompt as shown below:

```
A:\AWDFLASH xxxx.bin
```

Follow the instruction through the process. Don't turn off power or reset the system until the BIOS upgrade has been completed.

If you require more detailed information concerning AWDFLASH Utility, for example, the different usage of parameters, please type A:\>AWDFLASH /?

Note: Because the BIOS Software will be updated constantly, the following BIOS screens and descriptions are for reference purposes only and may not reflect your BIOS screens exactly.



AWARD BIOS Description

Entering Setup

Power on the computer, when the following message briefly appears at the bottom of the screen during the POST (Power On Self Test), press key to enter the AWARD BIOS CMOS Setup Utility.

Press to enter SETUP

When you have entered, the Main Menu (Figure 1) appears on the screen. Use the arrow keys to select among the items and press the <Enter> key to accept or enter the sub-menu.

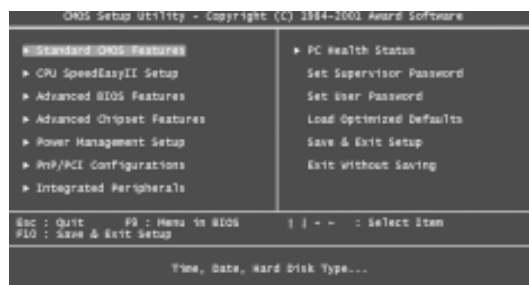

Figure-1 Main Menu

Load Optimized Defaults

The Optimized Defaults are common and efficient. It is recommended users load the optimized defaults first, then modify the needed configuration settings.

Standard CMOS Features Setup

The basic CMOS settings included in “Standard CMOS Features” are Date, Time, Hard Disk Drive Types, Floppy Disk Drive Types, and VGA etc. Use the arrow keys to highlight the item, then use the <PgUp> or <PgDn> keys to select the value desired in each item.

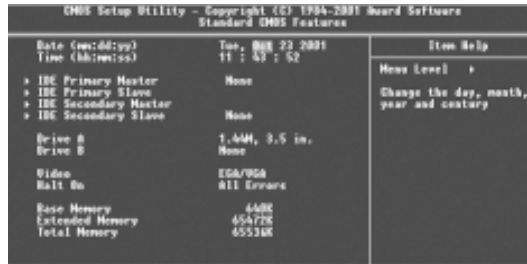

Figure-2 Standard CMOS Setup Menu

For the items marked, press enter, a window will pop up as shown below. You can view detailed information or make modifications.



Figure-2-1 IDE Primary Master Setup Menu

Hard Disk

Primary Master/Primary Slave/Secondary Master/Secondary Slave

These categories identify the HDD types of 2 IDE channels installed in the computer system. There are three choices provided for the Enhanced IDE BIOS: None, Auto, and Manual. 'None' means no HDD is installed or set; 'Auto' means the system can auto-detect the hard disk when booting up; by choosing 'Manual', the related information should be entered regarding the following items. Enter the information directly from the keyboard and press < Enter>:

CYLS	number of cylinders	HEAD	number of heads
PRECOMP	write pre-compensation	LANDZ	landing zone
SECTOR	number of sectors	MODE	HDD access mode



The Award BIOS supports 3 HDD modes: NORMAL, LBA and LARGE.

NORMAL

Generic access mode in which neither the BIOS nor the IDE controller will make any transformation during accessing. The maximum number of cylinders, heads and sectors for NORMAL mode are 1024,16 and 63.

If the user sets his HDD to NORMAL mode, the maximum accessible HDD size will be 528 megabytes even though its physical size may be greater than that.

LBA (Logical Block Addressing) mode

A new HDD accessing method to overcome the 528 Megabyte bottleneck. The number of cylinders, heads and sectors shown in setup may not be the number physically contained in the HDD.

During HDD accessing, the IDE controller will transform the logical address described by sector, head and cylinder number into its own physical address inside the HDD.

LARGE mode

Some IDE HDDs contain more than 1024 cylinder without LBA support (in some cases, users do not want LBA). The Award BIOS provides another alternative to support these kinds of HDD.

BIOS tricks DOS (or other OS) into dividing the number of cylinders is less than 1024 by dividing it by 2. At the same time, the number of heads is multiplied by 2. A reverse transformation process will be made inside INT13h in order to access the right HDD address.

If using Auto detect, the BIOS will automatically detect the IDE hard disk mode and set it as one of the three modes.

Remark

To support LBA or LARGE mode of HDDs, there must be some softwares involved which are located in Award HDD Service Routine(INT13h).It may fail to access a HDD with LBA (LARGE) mode selected if you are running under an Operating System which replaces the whole INT 13h.



Video

Set this field to the type of video display card installed in your system.

EGA/ VGA	Enhanced Graphics Adapter / Video Graphic Array. For EGA, VGA, SEGA, SVGA, or PGA monitor adapters.
CGA 40	Color Graphic Adapter, powering up in 40 column mode.
CGA 80	Color Graphic Adapter, powering up in 80 column mode.
MONO	Monochrome adapter, including high resolution monochrome adapters.

Halt On

This category determines whether or not the computer will stop if an error is detected during powering up.

No errors	The system boot will not stop for any errors that may be detected.
All errors	Whenever the BIOS detects a non-fatal error, the system will stop and you will be prompted.
All, But Keyboard	The system boot will not stop for a keyboard error; but it will stop for all other errors.
All, But Diskette	The system boot will not stop for a disk error; but it will stop for all other errors.
All, But Disk/Key	The system boot will not stop for a keyboard or disk error, but it will stop for all other errors.

Memory

This is a Display-Only Category, determined by POST (Power On Self Test) of the BIOS.

Base Memory	The POST of the BIOS will determine the amount of base (or conventional) memory installed in the system.
Extended Memory	The BIOS determines how much extended memory is presented during the POST.
Total Memory	Total memory of the system



CPU SpeedEasyII Setup



Figure-3 CPU SpeedEasyII Setup Menu

The following indicates the options for each item and describes their meaning.

Item	Option	Description
• CPU Clock Ratio	8~23	Select the multiplication of processor core frequency. This item is only for users who understand all the CPU parameters. However the multiplier setting will not function for bus ratio locked processor, only bus ratio unlocked processor.
• AGP Voltage	Normal +10%	Adjust AGP Voltage as default. Increase AGP Voltage manually.
• DDR Voltage	Normal +10%	Adjust DDR Voltage as default. Increase DDR Voltage manually.
• CPU Voltage	Default -0.075V ... +0.300V	Adjust CPU Voltage as default. Adjust CPU Voltage manually.
• CPU Host/PCI Clock	Default 100/33MHz ... 126/36MHz	Set CPU/PCI Clock as default. Set CPU/PCI Clock manually.

Warning: Be sure your selection is right. CPU over speed will be dangerous. Adjust CPU core voltage may cause damage to some processor! We will not be responsible for any damages caused.



Advanced BIOS Features Setup



Figure-4 Advanced BIOS Features Menu

The following indicates the options for each item and describes their meaning.

<u>Item</u>	<u>Option</u>	<u>Description</u>
• QDI BootEasy Feature	<i>Disabled</i>	PC boots in the legacy BIOS way.
	<i>Enabled</i>	PC boots in rapid speed, without any redundant waiting for the displaying of starting OS.
• ChipAwayVirus On Guard	<i>Enabled</i>	Guard against boot virus threats early in the boot cycle, before they have a chance to load into your system, ensuring your computer boots to a clean operating system.
	<i>Disabled</i>	Disable this function.
• CPU L1&L2 Cache	<i>Enabled</i>	Enable CPU L1/L2 cache.
	<i>Disabled</i>	Disable CPU L1/L2 cache.
• Quick Power On Self Test	<i>Enabled</i>	Allow the system to skip certain tests while booting. This will decrease the time needed to boot the system.
	<i>Disabled</i>	Normal POST.
• First (Second, Third) Boot Device	<i>Disabled</i>	Select Your Boot Device Priority. It could be Disabled, Floppy, LS/ZIP, HDD-0, HDD-1, HDD-2, HDD-3, SCSI, CDROM, LAN.
	<i>Floppy/LS120 /CDROM</i>	
	...	



• Swap Floppy Drive	<i>Enabled</i> <i>Disabled</i>	If the system has two floppy drives, choose enable to assign physical drive B to logical drive A and vice-versa.
• Boot Up NumLock Status	<i>On</i> <i>Off</i>	Keypad is used as number keys. Keypad is used as arrow keys.
• Gate A20 Option	<i>Normal</i> <i>Fast</i>	The A20 signal is controlled by the keyboard controller. The A20 signal is controlled by Port92.
• Typematic Rate Setting	<i>Enabled</i> <i>Disabled</i>	Keystrokes repeat at a rate determined by the keyboard controller - when enabled, the typematic rate and typematic delay can be selected.
• Typematic Rate (chars/sec)	<i>6-30</i>	The rate at which character repeats when you hold down a key.
• Typematic Delay (Msec)	<i>250-1000</i>	The delay before keystrokes begin to repeat.
• Security Option	<i>Setup</i> <i>System</i>	Select whether the password is required every time the system boot or only when you enter setup.
• OS Select For DRAM>64MB	<i>Non-OS2</i> <i>OS2</i>	Select OS2 only if you are running OS/2 operating system with more than 64MB of RAM.
• HDD S.M.A.R.T. Capability	<i>Enabled</i> <i>Disabled</i>	Enable hard disk S.M.A.R.T. support. Invalidate this feature.
• Report NO FDD for WIN 95	<i>Yes</i> <i>No</i>	Report NO Floppy Disk Drive for WIN 95 to release IRQ6. Do not report No Floppy Disk Drive for WIN 95.
• Small Logo(EPA) Show	<i>Enabled</i> <i>Disabled</i>	The EPA logo will be shown when system bootup. The EPA logo will not be shown when system bootup.
• Show Bootup Logo	<i>Enabled</i> <i>Disabled</i>	The QDI logo will be shown when system bootup. The QDI logo will not be shown when system bootup.
• Flash Write Protect	<i>Enabled</i> <i>Disabled</i>	This option is for protecting the system BIOS from being attacked by severe virus such as CIH. Disable you to upgrade the BIOS. Enable you to upgrade the BIOS.



Advanced Chipset Features Setup



Figure-5 Advanced Chipset Features Menu

The following indicates the options for each item and describes their meaning.

Item	Option	Description
• DRAM Timing Selectable	<i>By User</i> <i>By SPD</i>	DRAM timing is defined by user. DRAM timing is defined by SPD.
• CAS Latency Time	1.5~3	Set CAS latency time.
• Active to Precharge Delay	5,6,7	Set precharge delay time.
• DRAM RAS# to CAS# Delay	2,3	Set DRAM RAS# to CAS# delay 3 SCLKs or 2 SCLKs.
• DRAM RAS# Precharge	2,3	Set DRAM RAS# precharge as 3 or 2.
• DRAM Data Integrity Mode	<i>ECC</i> <i>Non-ECC</i>	This option allows you to select the Parity or ECC (Error-Checking and Correcting), according to the type of installed DRAM.
• Memory Frequency For	<i>Auto</i> <i>DDR200</i> <i>DDR266</i>	Set Memory Frequency.
• Dram Read Thermal Mgmt	<i>Enabled</i> <i>Disabled</i>	Set Dram Read Thermal Management.
• System BIOS Cacheable	<i>Enabled</i> <i>Disabled</i>	Besides conventional memory, the system BIOS area is also cacheable. System BIOS area is not cacheable.



• Video BIOS Cacheable	<i>Enabled</i>	Besides conventional memory, video BIOS area is also cacheable.
	<i>Disabled</i>	Video BIOS area is not cacheable.
• Video RAM Cacheable	<i>Enabled</i>	Besides conventional memory, video RAM area is also cacheable.
	<i>Disabled</i>	Video RAM area is not cacheable.
• Memory hole at 15M-16M	<i>Enabled</i>	Memory hole at 15-16M is reserved for expanded ISA card.
	<i>Disabled</i>	Do not set this memory hole.
• Delayed Transaction	<i>Enabled</i>	Enable Delayed Transaction.
	<i>Disabled</i>	Disable Delayed Transaction.
• AGP Aperture Size	<i>4/8/16/32MB</i>	Set the effective size of the Graphics Aperture to be used in the particular GART Configuration.
	<i>64/128MB</i>	
	<i>256MB</i>	
• Delay Prior to thermal	<i>4/8/16Min</i>	Setting time for CPU automatically enters thermal mode.
	<i>32Min</i>	
• Auto Detect PCI Clk	<i>Enabled</i>	Close empty PCI clock to reduce EMI.
	<i>Disabled</i>	Do not close empty PCI clock.
• Spread Spectrum	<i>+/-0.25%</i>	Enable Clock Spread Spectrum to reduce EMI.
	<i>...</i>	
	<i>+/-0.38%</i>	
	<i>Disabled</i>	



Power Management Setup



Figure-6 Power Management Setup Menu

The following indicates the options for each item and describes their meaning.

<u>Item</u>	<u>Option</u>	<u>Description</u>
• ACPI function	<i>Enabled</i>	Enable ACPI function.
	<i>Disabled</i>	Disable this function.
• ACPI Suspend Type	<i>S1(POS)</i>	Select the ACPI suspend type.
	<i>S3(STR)</i>	
• Power Management	<i>User Define</i>	Users can configure their own Power Management Timer.
	<i>Min Saving</i>	Pre - defined timer values are used. All timers are in their MAX values.
	<i>Max Saving</i>	Pre - defined timer values are used. All timers are in their MIN values.
• Video Off Method	<i>Blank Screen</i>	The system BIOS will only blank off the screen when disabling video.
	<i>V / H SYNC + Blank</i>	In addition to Blank Screen, BIOS will also turn off the V-SYNC & H - SYNC signals from VGA card to monitor.
	<i>DPMS</i>	This function is enabled only for VGA cards supporting DPMS. Note: When the green monitor does not detect the V/H-SYNC signals, the electron gun will be turned off.
• Video Off In Suspend	<i>Yes</i>	The system will disable video when entering suspend mode.
	<i>No</i>	Do not turn off video when entering suspend mode.



• Suspend Type	<i>Stop Grant</i> <i>PwrOn Suspend</i>	Select the Suspend type.
• MODEM Use IRQ	<i>3,4,5,7,9,</i> <i>10,11</i> <i>NA</i>	Special Wake-up event for Modem. This function is not applied.
• Suspend Mode	<i>Disabled</i> <i>1Min ~ 1Hour</i>	The system never enter Suspend mode by timer. Define the continuous idle time before the system enters Suspend mode. If any items defined in "PM Events" are on and activated, the system will be woken up.
• HDD Power Down	<i>Disabled</i> <i>1 - 15 Min</i>	HDD's motor will not be off by timer. Define the continuous HDD idle time before the HDD enters power saving mode (motor off).
• Soft-Off by PWR-BTTN	<i>Instant-Off</i> <i>Delay 4 sec</i>	The system will immediately power off once the power button is pressed. The system will power off when power button is pressed for 4 seconds.
• CPU THRM- Throttling	<i>12.5%, 25%,</i> <i>50%, 37.5%,</i> <i>62.5%, 75%,</i> <i>87.5%</i>	Select the duty cycle of the STPCLK# signal, slowing down the CPU speed when the system enters green mode.
• Wake-Up by PCI card	<i>Enabled</i> <i>Disabled</i>	Allow the system to be waked up by PCI card. Do not allow the system to be powered on by PCI card.
• Wake-Up by Ring/LAN	<i>Enabled</i> <i>Disabled</i>	Allow the system to be powered on when a Ring indicator signal comes up to UART1 or UART2 from external modem (to LAN Wake-up Header from LAN adapter or to modem Ring on Header from internal modem card). Do not allow Ring/LAN wake up.
• Resume by Alarm	<i>Enabled</i> <i>30Disabled</i>	RTC alarm can be used to generate a wake-up event to power up the system. RTC has no alarm function.



BIOS Description

- Primary IDE 0/1, *Enabled*
Secondary IDE 0/1 *Disabled* Reload global timer, when there's an IDE event.
Do not reload global timer.
- FDD/COM/LPT *Enabled*
Port *Disabled* Reload global timer, when there's a FDD/COM/
LPT event.
Do not reload global timer.
- PCI PIRQ[A - D]# *Enabled*
Disabled Reload global timer, when there's a PCI event.
Do not reload global timer.



PNP/PCI Configurations Setup



Figure-7 PNP/PCI Configurations Setup Menu

The following indicates the options for each item and describes their meaning.

Item	Option	Description
• Reset Configuration Data	<i>Enabled</i> <i>Disabled</i>	The system BIOS will reset configuration data once then automatically set this item as disabled. Disable this function.
• Resources Controlled By	<i>Manual</i> <i>Auto(ESCD)</i>	Assign the system resources manually. Assign system resources automatically by BIOS.
• PCI/VGA Palette Snoop	<i>Enabled</i> <i>Disabled</i>	Enable PCI/VGA Palette Snoop. Disable PCI/VGA Palette Snoop.



Integrated Peripherals



Figure-8 Integrated Peripherals Menu

The following indicates the options for each item and describes their meaning.

Item	Option	Description
• On-Chip Primary/Secondary PCI IDE	<i>Enabled</i> <i>Disabled</i>	On-Chip Primary/Secondary PCI IDE is enabled. On-Chip Primary/Secondary PCI IDE is disabled.
• IDE Primary/ Secondary Master/Slave PIO	<i>Mode 0 - 4</i> <i>Auto</i>	Define the IDE primary/secondary master/slave PIO mode. The IDE PIO mode is defined by auto -detection.
• IDE Primary/ Secondary Master/Slave UDMA	<i>Auto</i> <i>Disabled</i>	Ultra DMA mode will be enabled if an Ultra DMA device is detected. Disable this function.
• USB Controller	<i>Enabled</i> <i>Disabled</i>	Enable onchip USB controller. Disable onchip USB controller.
• USB Keyboard Support	<i>Enabled</i> <i>Disabled</i>	Support USB Keyboard under legacy OS. Do not support USB Keyboard under legacy OS.
• AC97 Audio	<i>Auto</i> <i>Disabled</i>	If audio codec was installed on board, the AC97 Audio function can be used. otherwise, the function is disabled. Disable the AC97 Audio onboard.
• AC97 Modem	<i>Auto</i> <i>Disabled</i>	If modem codec was installed on board, the AC97 modem function can be used. otherwise, the function is disabled. Disable the AC97 Modem onboard.



- | | | |
|-----------------------------|---|---|
| • Onboard/CNR LAN Selection | <i>Auto</i> | If a CNR Interface is enabled, the onboard LAN will be automatically disabled. Otherwise, the onboard LAN is enabled. |
| | <i>Onboard</i> | The onboard LAN is enabled. |
| | <i>Ext.CNR</i> | CNR Interface is enabled. |
| • Init Display First | <i>PCI Slot</i> | Initialize the PCI VGA first. |
| | <i>AGP</i> | Initialize the AGP first. |
| • IDE HDD Block Mode | <i>Enabled</i> | Allow IDE HDD to read/write several sectors once. |
| | <i>Disabled</i> | IDE HDD only reads/writes a sector once. |
| • KBC input clock | <i>6/8 MHz</i>
<i>12/16 MHz</i> | Set the PS/2 Keyboard input clock as 6/8/12 / 16MHz. |
| • Power On Function | <i>Button only</i> | Power on by power button. |
| | <i>Password</i> | Power on with keyboard password. |
| • KB Power ON Password | <i>Enter</i> | Enter keyboard password. |
| • Onboard FDC Controller | <i>Enabled</i> | Onboard floppy disk controller is enabled. |
| | <i>Disabled</i> | Onboard floppy disk controller is disabled. |
| • Onboard Serial Port 1/2 | <i>3F8/IRQ4</i> | Define the onboard serial port address and required interrupt number. |
| | <i>2F8/IRQ3</i> | |
| | <i>3E8/IRQ4</i> | |
| | <i>2E8/IRQ3</i> | |
| | <i>Auto</i> | Onboard serial port address and IRQ are automatically assigned. |
| | <i>Disabled</i> | Onboard serial port is disabled. |
| • UART Mode Select | <i>Normal, IrDA</i>
<i>ASKIR</i> | Set UART mode. |
| • Rx/D, Tx/D Active | <i>Hi, Lo/Lo, Hi</i>
<i>Lo, Lo/ Hi, Hi</i> | Default is recommended. |
| • IR Transmission Delay | <i>Enabled</i> | Enable IR Transmission delay function. |
| | <i>Disabled</i> | Disable IR Transmission delay function. |
| • UR2 Duplex Mode | <i>Half</i>
<i>Full</i> | Default is recommended. |



BIOS Description

- | | | |
|-------------------------|--|---|
| • Use IR Pins | <i>IR-Rx2Tx2</i>
<i>RxD2, TxD2</i> | Default is recommended. |
| • Onboard Parallel Port | <i>378/IRQ7</i>
<i>278/IRQ5</i>
<i>3BC/IRQ7</i>
<i>Disabled</i> | Define parallel port address and IRQ channel.

Onboard parallel port is disabled. |
| • Parallel Port Mode | <i>SPP</i>
<i>EPP</i>
<i>ECP</i>
<i>ECP+EPP</i> | Define the parallel port mode. |
| • EPP Mode Select | <i>EPP1.7</i>
<i>EPP1.9</i> | Set EPP Mode as EPP 1.7 or EPP1.9 Version. |
| • ECP Mode Use DMA | <i>3</i>
<i>1</i> | Set ECP Mode Use DMA 1 or 3. |
| • PWRON After PWR-Fail | <i>OFF,ON</i>
<i>Former-Sts</i> | The system remains OFF/ON/Former state when the AC power supply resumes. |
| • Game Port Address | <i>Disabled</i>
<i>201,209</i> | This option is used to configure Game Port Address. |
| • Midi Port Address | <i>Disabled</i>
<i>290</i>
<i>300</i>
<i>330</i> | This option is used to configure Midi Port Address. |
| • Midi Port IRQ | <i>5</i>
<i>10</i> | This option is used to configure Midi Port IRQ. |



PC Health Status

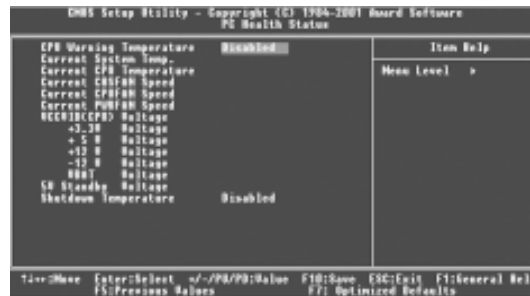

Figure-9 PC Health Status Menu

The following indicates the options for each item and describes their meaning.

<u>Item</u>	<u>Option</u>	<u>Description</u>
<ul style="list-style-type: none"> • CPU Warning Temperature 	<ul style="list-style-type: none"> 50°C/122°F 53°C/127°F 56°C/133°F 60°C/140°F 63°C/145°F 66°C/151°F 70°C/158°F 75°C/167°F 80°C/176°F 85°C/185°F 90°C/194°F 95°C/205°F Disabled 	<ul style="list-style-type: none"> An alarm will beep when the CPU temperature reaches the previous setting, 50°C/122°F, 53°C/127°F, 56°C/133°F, 60°C/140°F, 63°C/145°F, 66°C/151°F, 70°C/158°F, 75°C/167°F, 80°C/176°F, 85°C/185°F, 90°C/194°F, 95°C/205°F. No alarm beep.
<ul style="list-style-type: none"> • Current System Temp. 		The temperature inside the chassis.
<ul style="list-style-type: none"> • Current CPU Temperature 		The temperature of CPU.
<ul style="list-style-type: none"> • Current CHSFAN Speed • Current CPUFAN Speed • Current PWRFAN Speed 		RPM (Revolution Per Minute) Speed of fan which is connected to the fan header, CPUFAN, CHSFAN or PWRFAN. Fan speed value is based on an assumption that tachometer signal is two pulses per revolution. In other cases, you should regard it relatively.



- VCCVID(CPU) Voltage,
+3.3V
+5 V
+12 V
-12 V
VBAT Voltage
5V Standby Voltage

Display current voltage value including all significant voltages of the mainboard.
+3.3V, +5V, +12V, -12V are voltages from the power supply.

VCCVID (CPU) Voltage is the CPU core voltage from the on board switching Power Supply. The VBAT Voltage is the voltage of battery.
- Shutdown Temperature

60°C/140°F
65°C/149°F
70°C/158°F
75°C/167°F
Disabled

The system will shut down automatically under the ACPI OS when the CPU temperature reaches the previous setting.

The system remains on regardless of how much the CPU temperature is.



Password Setting

When this function is selected, the following message appears at the center of the screen to assist you in creating a password.

ENTER PASSWORD

Type the password, up to eight characters, and press <Enter>. The password typed now will clear any previously entered password from CMOS memory. You will be asked to confirm the password. Type the password again and press <Enter>. You may also press <Esc> to abort the selection.

To disable password, just press <Enter> when you are prompted to enter password. A message will confirm the password being disabled. Once the password is disabled, the system will boot and you can enter BIOS Setup freely.

PASSWORD DISABLED

If you have selected “**System**” in “Security Option” of “BIOS Features Setup” menu, you will be prompted for the password every time the system reboots or any time you try to enter BIOS Setup.

If you have selected “**Setup**” at “Security Option” from “BIOS Features Setup” menu, you will be prompted for the password only when you enter BIOS Setup.

Supervisor Password has higher priority than User Password. You can use Supervisor Password when booting the system or entering BIOS Setup to modify all settings. Also you can use User Password when booting the system or entering BIOS Setup but can not modify any setting if Supervisor Password is enabled.

Boot with BIOS defaults

If you have made all the changes to CMOS values and the system can not boot with the CMOS values selected in setup, clear CMOS after power-down, then power on again. System will boot with BIOS default settings.



Appendix

QDI Utility CD

A QDI Utility CD is supplied with this mainboard, the contents contained in it are shown as below:

1. Driver Install

Using this choice, you can install all the drivers for your mainboard easily. You should install the drivers in order, and you need to restart your computer until all the drivers are installed.

- | | |
|---------------------------|-----------------------------|
| A. Chipset software | B. Network Driver(optional) |
| C. Audio Driver(optional) | D. DirectX |

2. Accessory

- | | |
|-----------------------------|-------------------|
| A: QDI ManageEasy(optional) | B: QDI StepEasyII |
| C: Norton AntiVirus | D: QFlash |

3. Browse CD

You could read all the contents contained in this CD, including Utility and Documents.

The files included in **Utility** are:

- | | |
|-----------------|--------------|
| A. Awdflash.exe | B. Cblog.exe |
| C. Lf.exe | |

The files included in **Documents** are:

- | |
|--|
| A. Adobe Acrobat Reader V3.0 - Ar32e301.exe |
| B. RecoveryEasy-FR.doc, PlatiniX 2D FR.doc, Handbuch-manageEasy(optional),etc. |



QDI ManageEasyV2.0(optional)

It is well known that guaranteeing the computer's security and reliability is essential. Especially today, effectively managing and monitoring the computer's hardware is even more important; because processing and exchanging critical data through computer and network are happening everyday.

Moving with the computer's development, the system of the computer will become more and more complex; at the same time, the control computer's hardware will be strengthened. Today, it is possible to monitor and manage your complex hardware from Windows 9X and Windows NT. QDI ManageEasy is a system tool, a bridge between the complex hardware and OS, used to access hardware status and to execute control functions. It supports stronger functions for Windows 9X and Windows NT. These functions enables you to view more than one hundred of the basic information about the system and monitor some key reference data concerning computer health in real time. QDI ManageEasy also helps you to use remote access and control computers in your local area network. With QDI ManageEasy, you can improve your management level.

Installation of QDI ManageEasy V2.0

Run Setup.exe from the utility CD directory \QME2 to install the QDI ManageEasy V2.0. The QDI ManageEasy Setup Wizard will guide you through the installation process. For detailed information on how to use QDI ManageEasy V2.0, please refer to the QDI ManageEasy V2.0 online help.

BIOS-ProtectEasy

The BIOS of the mainboard is contained inside the Flash ROM. Severe viruses such as CIH virus are so dangerous that it may overwrite the BIOS of the mainboard. If the BIOS has been damaged, the system will be unable to boot. We provide the following solution which protects the system BIOS from being attacked by such viruses.

There are two choices which implements this function.

1. Set the jumper (JAV) as closed, the BIOS can not be overwritten.
2. Set the jumper (JAV) as opened, meanwhile set "Flash Write Protect" as Enabled in AWARD BIOS CMOS Setup. In this way, the BIOS can not be overwritten, but the DMI information can be updated.

Norton AntiVirus

When you install Norton AntiVirus and accept options, your computer is safe. Norton AntiVirus automatically checks boot records for viruses at system startup, checks programs for viruses at the time you use them, scans all local hard drives for viruses once per week, and monitors your computer for any activity that might indicate the work of a virus in action. It also scans files you download from the internet and checks floppy disks for boot viruses when you use them. The list below shows the most important tasks Norton AntiVirus helps you perform: scan for viruses on your computer; remove viruses from your computer; update your virus protection with LiveUpdate; quarantine an infected file.

You can go to the Symantec Web site to view an online tutorial:

<http://www.symantec.com/techsupp/tutorial/nav2001>



LogoEasyII

Thank you for using QDI upgraded innovation— LogoEasy II, which is completely compatible with LOGOEASY. Both BMP-format and JPEG-format graphics files can be used. It supports the high-resolution 640*480 or 800*600 image display and full-screen, top right corner or bottom right corner display, making your boot logo colorful and diversiform.

When you power on or reset your system, the picture shown below will be displayed on the screen.



You can use “**LogoEasy II**” to replace it by any other logo which you prefer.

We provide two Utilities in the QDI Driver CD, which bring user two means to select:

A. Using **CBLOGO.EXE** Utility (Under DOS):

1. Copy “CBLOGO.EXE” and “AWDFLASH.EXE” from the directory \Utility located on QDI Driver CD to your hard disk.
2. Get the BIOS file from “AWDFLASH.EXE” or Download the BIOS file from the Website (<http://www.qdigrp.com>) and copy the BIOS file (xxxxxx.bin) to your hard disk.
3. Boot the system into DOS environment, Put your favor picture into BIOS file by “CBLOGO.EXE” command. For example: CBLOGO.EXE xxxxxx.bin myphoto.bmp
4. Flash the BIOS to motherboard by “AWDFLASH.EXE”. For example: AWDFLASH xxxxxx.bin

A. Using **QFlash** (Under Windows):

1. Download the QFlash Utility from the Website (<http://www.qdigrp.com>) or get it from QDI Driver CD.
2. Run QFlash program step by step, following the directions until complete it.

Reboot the system, you can see the new picture displayed on the screen. If you require more parameters information concerning “CBLOGO.EXE”, please refer to the online help. If you don't prefer the logo displayed on the screen during bootup, set the “Show Bootup Logo” option as Disabled in the “ADVANCED BIOS FEATURES” section of the BIOS.

*** We reserve the right of modifying the default full-logo of QDI without further notification.**



QDI BootEasy(English)

BootEasy is a new member of legend QDI Easy series, which is the latest innovation comes from legend QDI.



BootEasy Setup Menu

BootEasy technology enormously shorten the long BOOT process time of computers. Reducing the wait time every user has to suffer when starting their computer. BIOS without BootEasy has to perform many routines every time when the system starts, such as checking system core of the computer and initializing system peripherals. Now with the BootEasy, BIOS will not run these repetitive Processes any longer , PC can boot-up without any redundant waiting for the displaying of starting OS. BootEasy is quite easy to use , choose the right option in CMOS SETUP, (refer to Advanced BIOS Features) it can be easily booted quickly. BootEasy save all the information when PC first normally boot-up, and it restores all the parameters for the system and thus let the PC boot freely and rapidly.

Note:

1. Under the following conditions, PC will boot-up in normal way.
 - (1) PC boot-up for the first times after set option as Enabled.
 - (2) the system information saved by BIOS was damaged.
 - (3) PC fail to boot-up continually over three times.
- Note: Please make sure the jumper "JAV" is set as OPEN under these conditions.
2. Don't power off or reset system while BootEasy initializing.
 3. Set "QDI BootEasy Feature" as "Disabled" before you replace system equipment.
 - Set "QDI BootEasy Feature" as "Enabled" after you accomplished replacing.



QDI BootEasy(Italy)

Boot Easy e il nuovo software membro della famiglia legend QDI Easy, quale innovazione da LEGEND- QDI.



BootEasy Setup Menu

La tecnologia Boot Easy abbrevia gli enormi tempi del computer in fase di BOOT. Riduce le attese d'ogni utente che accede al suo computer. Il BIOS senza Boot Easy deve eseguire molte routines ogni qualvolta il sistema parte, come controllo della sezione centrale del computer oltre che inizializzare le varie periferiche esterne. Ora con Boot Easy, il BIOS non eseguirà questi processi ripetitivi così lunghi, il Pc potrà partire senza attese ridondanti prima della presentazione del logo del sistema operativo.

Boot Easy e' facile da usare, basta scegliere la giusta opzione nel BIOS setup, (riferito al Advanced BIOS Features) ed il computer potrà velocemente ripartire. Boot Easy salva tutte le informazioni al primo avvio normale, tutti i parametri saranno restituiti ai BOOT successivi.

Nota:

1 Il Pc partira' normalmente se saranno rispettate le seguenti condizioni

- (1) Il Pc fa' il primo BOOT con l'opzione Enable
- (2) Le informazioni su i parametri salvati dal BIOS non erano DANNEGIATE
- (3) Il PC fallisce l'avvio piu' di tre volte

Non spegnere o resetta il PC durante l'avvio di BOOT EASY

Disabilita il "QDI BootEasy Feature" prima di sostituire le periferiche ad esso collegate (HDD, CD-ROM, ecc.) solo dopo riabilita il "QDI BootEasy Feature".



QDI BootEasy(German)

BootEasy ist eine Neuentwicklung von Legend QDI, die neue Innovation der QDI Easy – Technologien.



BootEasy Setup Menu

Mit der BootEasy- Technologie Technik wird der Bootvorgang nur noch vier bis fünf Sekunden in Anspruch nehmen, bis das Betriebssystem geladen wird. Der Grund für die lange Wartezeit liegt in den Routine-Abfragen, die das BIOS bei jedem Start abarbeitet. So wird beispielsweise jedes Mal die Taktfrequenz des Prozessors geprüft oder angeschlossene Geräte aktiviert.

Die BootEasy-Technik prüft diese Punkte nur beim erstmaligen Start des Rechners und speichert die Ergebnisse in einem Flash ROM. Beim nächsten Start ruft das System lediglich diese Informationen aus dem Speicher ab und kann so innerhalb von wenigen Sekunden den Boot-Prozess abschließen.

Bei Änderungen am System, beispielsweise nach dem Einbau eines neuen Prozessors, muss deshalb zuvor die BootEasy-Funktion deaktiviert werden, beim nächsten Start werden die neuen Informationen dann erneut abgespeichert.

Falls Fehler im Flash ROM den Bootvorgang behindern, versucht das System drei Mal den Rechner hochzufahren, bei Misserfolg schaltet es auf die althergebrachte Art zu booten um, das heißt, es dauert wieder ebenso lang wie früher. Anschließend kann die BootEasy – Technik wieder aktiviert werden.

RecoveryEasy

Introduction:

RecoveryEasy, the latest QDI innovation, is able to protect the system from being destroyed, by creating a so-called “mirror partition” for a current hard disk partition and backing up all the data to the mirror area. This ideal utility provides disk partition, disk data backup/recovery, CMOS settings backup/recovery and multi-boot functions. RecoveryEasy is also able to prevent the system from being attacked by different kinds of boot virus or other severe virus such as CIH. In case the system is ruined either by mistake or virus, the system can be recovered from the mirror partition. It applies the build-in BIOS technology that does not occupy either the hard disk space or the system memory. It’s the best choice for both corporations and PC users.

Operation Process:

There are two hotkeys – Ctrl+Bksp and F12 for RecoveryEasy to enter “Partition” and “Recovery” user interfaces accordingly during BIOS booting up. If two or more hard disks are installed, use F5 key to choose the hard disk.

1. Partition Interface (see figure-1)

Users can create and delete partitions/mirror partitions, activate partitions, and uninstall RecoveryEasy in Partition User Interface.



figure-1 Partition Interface

1.1 Install RecoveryEasy for the first time

- a. The utility checks the previous disk partition at first, and displays the status of the first four partitions. If there are more than four disk partitions, users will be asked to delete the redundant disk partitions, since only four partitions that can be activated are allowed to exist. However, if there’re only four or fewer partitions, users can follow the system prompt and choose to install RecoveryEasy based on the previous disk partitions. In this way, the original extension partitions will be changed to normal ones, and probably the sequence of the partitions will be changed also, but the contents contained in each partition will remain the same.



- b. If choosing to install RecoveryEasy on an absolutely clear disk, the utility will delete all the previous partitions.
- c. The password is set as default setting “qdiqdi” after installing RecoveryEasy.

1.2 CREATE PAR

Function : Creates a new partition.

Limitation : When no disk space remains or 4 partitions already exist, this button is disabled.

Steps : After pressing the “CREATE PAR” button.

- a. The system will prompt whether users want to create a mirror partition for it or not.
- b. If answering “Y”, input the new partition size in Megabyte. Notice that the maximum partition size that can be assigned is half of the left disk space, which is also displayed in the status line. Another half is for the mirror partition. If answering “N”, the whole disk space left can be assigned. See figure-2.

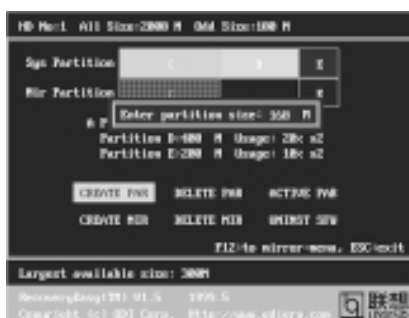

figure-2 Create Partition

Note:

- a. The system will prompt “Insert system floppy, then reset” when the first partition on the first hard disk is created.
- b. After using DOS6.xx boot disk to format C partition, the system should be reset in order to access the partition.
- c. In Windows system 1,048,576 bytes equal 1 Megabyte, while in RecoveryEasy 1,000,000 bytes equal 1 Megabyte, therefore a smaller size will be displayed in Windows system compared with the size displayed in RecoveryEasy.

1.3 DELETE PAR

Function : Deletes the last partition and its mirror partition.

Limitation : When no partition exists, this button is disabled.

Steps : After choosing this function, only the final partition can be deleted in order to keep the continuous disk space. If the warning message is confirmed, the partition will be deleted. By pressing “N” or “ESC” key, the system quits.



1.4 ACTIVE PAR

Function : Implements multi-boot function by activating one of the partitions.

Limitation : When no partition exists, this button is disabled.

Steps : If there're two or more partitions, choose one of them by pressing F5 key.

Note : After setting active partition, a letter "A" will be shown in front of this partition.

1.5 CREATE MIR

Function : Adds mirror partition for the disk partition that has no mirror.

Limitation : This function should be performed by order, for example, from partition 1 to 4. If no disk space remains or the last partition has its mirror partition already, this button is disabled.

Steps : After pressing the "CREATE MIR" button, use F5 key to choose the partition to create mirror. The partition of which the size is bigger than the left disk space will be ignored.

1.6 DELETE MIR

Function : Deletes the mirror partition.

Limitation : If there is no mirror partition, this button is disabled. This function should be performed in reverse order, for example, from partition 4 to 1.

Steps : After pressing the "DELETE MIR" button, only the final mirror partition can be deleted in order to keep the continuous disk space. If the warning message is confirmed, the mirror partition will be deleted. By pressing "N" or "ESC" key, the system quits.

1.7 UNINST SFW

Function : Uninstall RecoveryEasy.

Limitation : None.

Steps : After pressing the "UNINST SFW" button and the warning message is confirmed, RecoveryEasy will be uninstalled. By answering "N", the system quits.

Note : After RecoveryEasy is uninstalled, all the mirror areas have been disconnected with the relate partitions. If no partition is deleted or changed in size, or no other partition is created, users have chance to "Recover existing RecoveryEasy settings" when next time entering RecoveryEasy partition interface, meanwhile the password will be set as default setting "qdiqdi".

1.7 OTHERS

F12 : Switches to Recovery User Interface.

ESC : Exits from the Partition User Interface. If users made some mistakes, for example, wrongly delete a partition, do not press the "ESC" key, press the reset button on your system at once, in this way users can save their system.

**F5:**

- a. When two or more than two hard disks are installed on the system, use F5 key to choose the hard disk. Every time users use F5 key to switch the hard disk, the operation result for the previous hard disk is saved. When processing a certain hard disk, F5 key can be used to choose the partition.
- b. In addition, when two or more than two hard disks are installed, the sign of partitions will be changed from C, D, E, F to 1, 2, 3, 4 accordingly.

2. Recovery Interface (see figure-3)

Users can backup the partition to its mirror area, and recover the partition from its mirror area from Recovery User Interface. This interface also provides users with CMOS settings backup or recovery, and changing password functions.

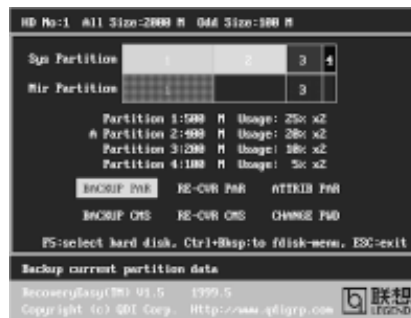

figure-3 Recovery User Interface

2.1 BACKUP PAR

Function : Backups the content of the partition to its mirror area.

Limitation : If no mirror partition exists, this button is disabled.

Steps:

- a. Use F5 key to choose the partition with mirror area existed.
- b. If the partition chosen has been backuped before, a warning message will be shown, and the time when last backup was done will be displayed in the status line. After confirming the warning message, the system performs the backup. By pressing "N" or "ESC" key, the system quits.

2.2 RE-CVR PAR

Function : Recovers the content from the mirror area to the relate partition.

Limitation : If users didn't backup any partitions before, this button is disabled.

Steps:

- a. Use F5 key to choose the backuped partition.
- b. The time when the latest backup was done will be displayed in the status line. After confirming the warning message, the system performs the content recovery. By pressing "N" or "ESC" key, the system quits.

Note:

- a. During the process of partition backup or recovery, a gauge will be shown as below, the backup or recovery speed is about 4-5Mbyte/s. See figure-4.

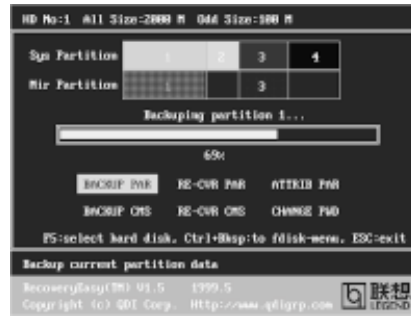

figure-4 Backup Partition

- b. If a disk I/O error occurs during the process of partition backup or recovery, this means there's physical damage on the hard disk, however users can ignore it and continue the process.

2.3 ATTRIB PAR

Function : Allows users to modify the properties of the partition (eg. FAT16 -> FAT32) after entering OS.

Limitation : None.

Steps : After pressing this button, turn on/off the switch.

Note:

- a. The switch resets to the default setting "disable" every time the system reboots.
- b. In order to implement this function, users need to enable the switch when installing the OS or modifying the partition properties. Please note: Do not create or delete partitions or change the partition size when modifying the partition properties.

2.4 BACKUP CMS

Function : Backups all CMOS settings.

Limitation : None.

Steps : After choosing this function, the current CMOS settings will be saved.

2.5 RE-CVR CMS

Function : Recovers all CMOS settings.

Limitation : None.

Steps : After choosing this function, the latest backup of the CMOS settings will be recovered. The system needs reboot in order to validate the new CMOS settings.

Note : If users have never backed up the CMOS settings, a wrong message will be shown after choosing this function.



2.6 CHANGE PWD

Function : Changes the password to enter RecoveryEasy Partition or Recovery User Interface.

Limitation : None.

Steps : Follow the system prompt, input the password no more than 6 characters twice. To delete the password, follow the system prompt and press the "Enter" key twice.

Note:

- a. The password should be no more than 6 characters, only digital and alphabetic letters are valid.
- b. Once the password is enabled, users will be asked to input the password every time they try to enter the RecoveryEasy user interfaces, and up to 3 times try is permitted.

2.7 Others

Ctrl+Bksp : Switches to Partition User Interface.

ESC : Exits from the Partition User Interface.

F5 : When two or more than two hard disks are installed on the system, use F5 key to choose the hard disk. When processing a certain hard disk, F5 key can be used to choose the partition.

FAQ:

1. What does RecoveryEasy do?

RecoveryEasy creates a so-called "mirror partition" with same size for the hard disk partition on the same hard disk, and then completely backups all the data sector by sector to the mirror area. This mirror partition is reserved to OS. When the OS ruins either by mistakes or virus, users can recover the partition from its mirror.

2. Does RecoveryEasy occupy the system resources?

Although some hard disk data protection applications can automatically protect the disk data in runtime, it lowers the system performance. Unlike these applications, RecoveryEasy need users to backup or restore data manually when needed, but it DOES NOT lower the system performance when the system is running. It does not occupy either hard disk space or system memory, additional floppy disk or ISA/PCI cards are unnecessary.

3. RecoveryEasy utilizes Build-in BIOS skill, what is build-in BIOS?

RecoveryEasy build-in BIOS means all functions of RecoveryEasy including creating partition, backuping and restoring partition are built in BIOS. Users just need to down load the latest BIOS from our Website (<http://www.qdigrp.com>) when wanting to upgrade (It's free!).



- 4. Are there any hard disk limitations of RecoveryEasy?**
RecoveryEasy supports all kinds of current IDE hard disks and has no limitation on the hard disk capacity. RecoveryEasy can not provide its function for some special hard disk types such as SCSI, but it will not affect their usage.
- 5. Are there any OS limitations of RecoveryEasy?**
RecoveryEasy supports current operating systems such as DOS, Windows 95/98. However in Windows NT, Windows 2000, Unix and OS2 systems, users should notice that the disk tools bundled in the OS could change the mirror partition. On the other hand, since users can create partition with RecoveryEasy, it is unnecessary to use other disk tools.
- 6. Why does the remainder size plus partitions size not match the total size shown in RecoveryEasy sometimes?**
When the location of partitions is not continuous, the above problem exists.
- 7. Are there any other disk partition tools that can modify the partition table made by RecoveryEasy?**
RecoveryEasy provides a write-protect function, so the disk tools such as Fdisk, Partition Magic, BootMenu, SmartDisk and BootStar can not modify the partition table created by RecoveryEasy. Some of the applications even terminate during operation. However the disk tools bundled in the OS such as Windows NT, Windows 2000, Unix and OS2 could change the mirror partition.
- 8. Why does it happen that a prompt “installation can not continue” pops up when installing Windows98 or a yellow exclamation mark shown beside IDE device in system properties?**
During Windows 98 installation, the installation program will write to MBR (Master Boot Record) which is protected by RecoveryEasy, therefore the installation will be terminated. To avoid this problem, a “ATTRIB PAR” button is provided in Recovery User Interface. Enable this switch before installing Windows 98, then the installation will be successfully completed. In order to remove the yellow question mark before IDE devices in Device Manager, enable this switch once more after system reboot.
- 9. Why does the converting of FAT16->FAT32 in PQ Magic go wrong?**
MBR will be accessed when converting FAT16 to FAT32 with PQ Magic, which is protected by RecoveryEasy, therefore the conversion will be invalid. Enabling the “ATTRIB PAR” switch from Recovery User Interface before converting can avoid this problem. It's the same situation as “FAT32 Converter” provided in Windows98.
- 10. What if partitions be wrongly deleted in RecoveryEasy?**
If users delete a partition in RecoveryEasy by mistake, they can save it by pressing the Reset button on their system at once. Do not press the “ESC”



key to quit RecoveryEasy, this will save the change. Do not try to create the partition again, since creating partition will clear all the content of the partition.

11. What is multi-boot?

RecoveryEasy can implement the multi-boot function by activating different partition. For example on the hard disk, partition C contains DOS, partition D contains Windows 95 version, partition E contains Windows 98 version, when activating partition C in RecoveryEasy, the system enters DOS, when activating partition E, the system enters Windows 98 version. At the same time, the sequence of the partitions is adjusted accordingly, partition E becomes C:, partition C becomes D: and partition D becomes E:. This function is the same as that of fdisk.exe, but the system needs reboot in order to make the change validate for fdisk.exe.

12. What if computer accidentally power off when backuping (recovering)?

The partition should be completely backuped or recovered. If the computer accidentally powers off, the partition should be backuped or recovered once again.

13. What if users lose the password?

To make sure the security, the password is saved in the hard disk. **It's very important for users to remember the password.** If forgetting the password, contact us, clearing CMOS is useless.

14. Does RecoveryEasy protect hard disk against CIH?

RecoveryEasy can strongly protect the hard disk from boot-virus, as well as the attack of CIH. If the system is attacked by CIH, RecoveryEasy will automatically recover the MBR and each partition boot record before system boots up, and try to recover the FAT. In this way the system can basically boot up, then users can use some anti-virus application to kill the virus. However this depends on how CIH virus affects the system. CIH normally outbreaks on 26th every month, if the system can not boot up that day, power off the computer instantly, and use the second safe way to recover the system, that is, recover the partition from its mirror area from Recovery User Interface. Remember to create a mirror partition and backup before virus attacks the system.



QDI StepEasyII

As one of the Legend QDI's innovations, StepEasyII is a powerful and efficient Easy Technology for PC DIY fans. It provides a friendly interface for you that you can adjust the CPU frequency conveniently and directly. It is so powerful that you can change the CPU frequency just in a few seconds under the operating system(Windows 95/98/ME/2000/NT) and have no need to reset the PC or change the jumpers. In addition, StepEasyII can decrease the risk of changing the CPU frequency to minimum. As long as you conform to the steps of tuning the CPU frequency, there is almost no risk to adjust the frequency. Its second strong function is system monitoring, enables you to view some key reference data concerning computer health in real time.

The following figure is the StepEasyII interface for your reference:

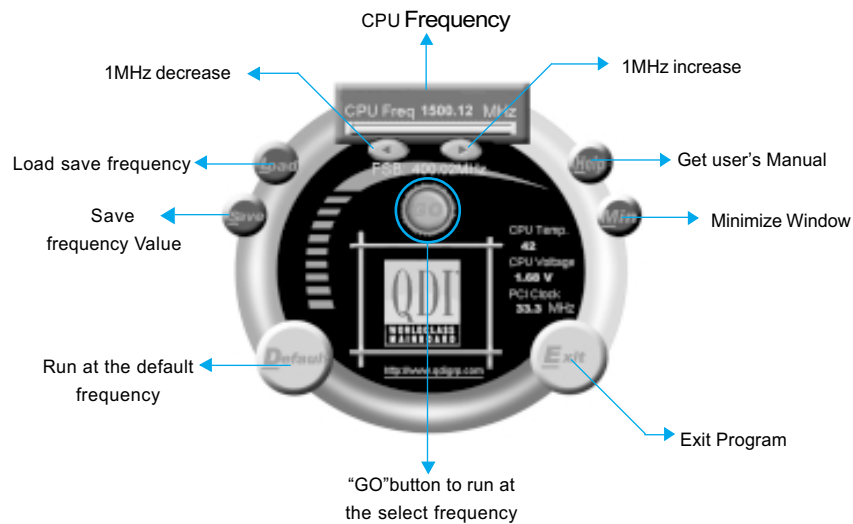

Installation

You can install the QDI StepEasyII by the following two means:

1. Run CD, select the installation of QDI StepEasyII, then, act step by step according to the interface prompt.
2. Browse CD and run the setup.exe in the relative directory.



Because there exists some risk for the CPU chip or the mainboard to change the CPU frequency , We suggest you read the manual carefully before installing QDI StepEasyII .

When start QDI StepEasyII, to avoid accident, we recommend you to close your other program before run StepEasyII.

1. You can click on the 1MHz increase (1MHz decrease) or press shortcut key "+"("-") to set the wanted frequency, then click on the "GO" button to get the wanted frequency.
2. Also, you can click on the "Default" button , then click on the "GO" button to get the default frequency.
3. StepEasyII considerately provides users to save his successful CPU tune frequency for later use .If user wants to save the current frequency , he can clicks on the "Save" button to realize it.
4. When click on the "Load" button , the saved CPU frequency is obtained immediately.
5. When click on the "Min" button, the utility will minimize to an icon in the right-bottom task tray. Whenever user clicks the QSE(QDI StepEasyII abbr.) icon in the task tray, the utility will be activated in the current window.
6. The real-time system information such as CPU temperature,CPU voltage and PCI clock will automatic shown on the ineterface.

Note:

1. QDI StepEasyII can only support the QDI motherboard with the clock chip that supports StepEasyII.
2. The performance of StepEasyII depends on the CPU, SDRAM, peripheral equipments and the software running.
3. There exist some risks to change the CPU frequency for the CPU or motherboard. StepEasyII can decrease the risks to minimum. But Legend QDI will not be responsible for any damages caused.
4. If the system halts while running StepEasyII, please press the power button until the system powers down .Restart your computer ,and the system will run in the normal status.
5. When the system was woken up from S3 or S4 status,please click on the "GO"button to run at the selected frequency.



SpeedEasyII Quick Setup

Procedures :

1. Correctly insert the CPU.
2. Plug in other configurations and restore the system.
3. Switch on power to the system and press the key to enter BIOS Setup.
4. Enter "CPU SpeedEasyII Setup" menu to set up the CPU speed.
5. Adjust AGP, DDR, CPU voltage.
6. Save and exit BIOS Setup, your system will now boot successfully.



CPU SpeedEasyII Setup Menu

Select <CPU SpeedEasyII Setup> item from the main menu and enter the sub-menu:



CPU SpeedEasyII Setup Menu

BIOS provides you with a set of basic values for your processor selection instead of the jumper settings. The processor speed can be manually selected on the “CPU SpeedEasyII SETUP” menu screen.

Warning:

Do not set CPU frequency higher than its working frequency. If you do, we will not be responsible for any damages caused.

Do not adjust CPU voltage higher than its working voltage. If you do, we will not be responsible for any damages caused.



Installation de la carte mère Platinix 2D :(French)

1. Assurez-vous que votre ensemble est complet: carte mère, câbles IDE et FLOPPY, notice d'utilisation et CD-ROM d'installation.
2. Vérifiez que l'alimentation est débranchée et reliez-vous à la terre par une courroie à votre poignet. A défaut, maintenez le contact de vos deux mains avec un objet lui-même relié à la terre, ou une partie en métal de votre système.
3. Fixez la carte mère dans le boîtier grâce aux vis fournies avec celui-ci.
4. Si votre carte mère est munie de cavaliers, placez les en fonction des options que vous souhaitez utiliser: réglage de la fréquence du processeur si votre carte n'est pas SpeedEasyII, fonction allumage par saisie du mot depasse... (voir le manuel, rubrique "configuration des cavaliers" pages 13 à 16)
5. Insérez le processeur dans son logement avec son ventilateur que vous brancherez au connecteur "CPUFAN".
6. Insérez la/les barrette(s) mémoire dans les slots RIMM.
7. Installez vos éventuelles cartes PCI et AMR dans les slots prévus à cet effet (voir page centrale du manuel).
8. Branchez vos périphériques IDE et FLOPPY sur les connecteurs prévus à cet effet grâce aux nappes fournies avec la carte. Vérifiez que le sens de branchement est correct (liseré rouge du câble sur la broche 1 du connecteur).
9. Reliez les câbles du boîtier aux connecteurs prévus à cet effet (Connecteur d'alimentation, LED de marche/arrêt, disque dur, haut-parleur... voir manuels pages 9 à 12). Refermez le boîtier.
10. Branchez les périphériques externes sur les sorties du fond de panier: clavier, souris PS/2, périphériques USB, moniteur, imprimante... (voir manuel pages 7-8)
11. Lorsque tous les éléments du système sont installés physiquement, rebranchez l'unité centrale.

Installation du système.

1. Démarrez votre système en pressant le bouton "POWER".
2. Pressez la touche "Suppr" pour entrer dans le setup du BIOS.
3. Dans le menu "SpeedEasyII CPU Setup", réglez la vitesse de votre processeur.



(ATTENTION: il est recommandé de ne pas sélectionner une fréquence supérieure à celle de votre processeur, nous déclinons toute responsabilité pour les dommages qui en résulteraient)]

4. Effectuez les autres réglages du BIOS selon votre configuration (nous vous conseillons fortement de maintenir les réglages par défaut afin d'éviter toute manipulation hasardeuse pouvant résulter en un dysfonctionnement). Pour plus d'informations sur les fonctions du BIOS, vous pouvez consulter la version française du manuel sur le CD-ROM.
5. Pressez la touche F10 ou choisissez "Save and exit" pour enregistrer vos paramètres et relancer la machine.
6. Installez votre système d'exploitation
7. Après installation, assurez-vous qu'il ne subsiste aucun conflit ou périphérique inconnu dans votre système.
8. Installation des pilotes:

1. Driver Install

Avec cette option, vous pouvez installer les pilotes de votre carte mère facilement. Vous devez installer les pilotes dans l'ordre et redémarrer votre ordinateur lorsque tous les pilotes sont installés.

- A. Pilotes du Chipset B. Pilote réseau C. Pilote audio
D. Pilote Midi E. DirectX

2. QDI ManageEasy(optional):

Lancez le setup.exe du répertoire \QME pour installer le ManageEasy(optional). Pour des informations détaillées sur le ManageEasy(optional), référez-vous au manuel ManageEasy(optional) du répertoire \Doc. N'oubliez pas de redémarrer votre système pour que les changements soient pris en compte.

3. RecoveryEasy

RecoveryEasy™ permet de protéger le système des destructions en créant une "partition miroir" de la partition courante du disque dur et en sauvegardant toutes les données dans ce "miroir".

Cette utilitaire fournit partition du disque, récupération/sauvegarde des données, récupération/sauvegarde des réglages du CMOS et fonctions multi-boot.



RecoveryEasy permet également la protection du système contre les divers types de virus de boot tels que CIH. Dans le cas où le système est perdu soit par erreur, soit à cause d'un virus, il peut être récupéré depuis la partition miroir. Cette innovation utilise la technologie du Bios intégré qui n'occupe ni l'espace disque, ni la mémoire du système. C'est la solution idéale pour l'utilisateur. Il faut presser les touches Ctrl + Bksp et F12 pour entrer dans les interfaces "Recovery" et "Partition" durant le démarrage du Bios.

ATTENTION : lisez attentivement le manuel du RecoveryEasy traduit sur le CD-ROM QDI avant d'installer cette fonction.

Très important : n'oubliez pas votre mot de passe, faute de quoi vous n'auriez plus accès au RecoveryEasy, même après avoir effectué un Clear CMOS.

QDI BootEasy

BootEasy est la dernière née des technologies Legend QDI. Voir figure page 14 du manuel en anglais. BootEasy permet au PC de démarrer plus rapidement lorsqu'on allume, reset ou relance le PC.

Avec le BootEasy, le PC peut démarrer en un instant, sans attente redondante pour afficher le démarrage du système d'exploitation.

BootEasy est facile à utiliser, il suffit de choisir l'option correcte dans le menu "Advanced Bios Features Setup".

BootEasy sauvegarde toutes les informations lorsque le PC boote et restaure les paramètres pour le système, permettant ainsi au PC de démarrer rapidement.

Note:

1. Le PC démarre de manière classique dans les cas suivants:
 - Premier démarrage après activation de l'option BootEasy
 - Informations sauvegardées endommagées
 - Echec au démarrage du PC à 3 reprises
2. N'arrêtez pas ou ne redémarrez pas le système lorsque BootEasy s'initialise
3. Placez "QDI BootEasy Feature" sur "Disabled" avant de changer un composant du système
Placez "QDI BootEasy Feature" sur "Enabled" après avoir effectué le changement.



Le menu SpeedEasyII

- I. Insérez le processeur correctement.
- II. Connectez les autres éléments du système (voir Installation).
- III. Au démarrage du système, pressez la touche <Suppr> pour entrer dans le Bios
- IV. Entrez dans le menu "CPU SpeedEasyII setup"
Note: si vous ne déterminez pas la vitesse de votre unité centrale, votresystème fonctionnera par défaut
- V. Sauvegardez et quittez le Bios.

CMOS Setup Utility – Copyright© 1984-1999 Award SoftwareSpeedEasyII CPU Setup

CPU Host/PCI Clock :	66/33MHz	Item Help
Close empty DIMM/PCI Clk:	Enabled	
Spread Spectrum	Disabled	Menu Level >

Le menu SpeedEasyII vous fournit un ensemble de valeurs. Vous pouvez sélectionner manuellement la vitesse de CPU dans ce menu soit en mode "SpeedEasyII" soit en mode "Jumper Emulation" (voir manuel).

ATTENTION: Ne pas sélectionner une fréquence de fonctionnement du CPU supérieure à celle indiquée par le constructeur. Nous déclinons toute responsabilité pour tout dégât qui en résulterait.



Instalación de la placa base Legend-QDI PlatiniX 2D:(Spanish)

1. Asegúrese que se incluyen los siguientes artículos: Placa base Legend-QDI PlatiniX 2D, 1 cable de datos para el puerto IDE y 1 cable de datos para el Floppy, jumpers, 1 manual de usuario Legend-QDI PlatiniX 2D y un disco compacto con los controladores de la placa base Legend-QDI PlatiniX 2D.
2. Asegúrese de que el cable de la fuente de alimentación esta desconectado y asegúrese de estar en contacto a masa utilizando una pulsera antiestática. Si no dispone de dicha pulsera, toque un objeto directamente conectado a masa o una parte metálica de su equipo como puede ser la caja de este.
3. Fije la placa base en la caja de su equipo con los tornillos especiales que acompañan a su caja.
4. Si la placa base necesita configurarse mediante jumpers, seleccione el valor correcto para la configuración de su equipo, como la frecuencia del procesador si su placa base no utiliza la tecnología QDI SpeedEasyII de Legend-QDI, la opción de iniciar el sistema mediante contraseña, etc. (Consulte la sección "Jumper Settings" del manual de su placa base Legend-QDI PlatiniX 2D, desde la página 19 hasta la página 24).
5. Inserte el procesador en el socket y conecte el ventilador del procesador en el conector de su placa base Legend-QDI PlatiniX 2D marcado como "CPUFAN".
6. Inserte los módulos de memoria en los bancos de memoria DIMM de su placa base Legend-QDI PlatiniX 2D.
7. Inserte las tarjetas PCI y/o la tarjeta CNR y AGP en las bahías de expansión de su placa base Legend-QDI PlatiniX 2D(localícelas en "el esquema de su placa base" en la parte final del manual de usuario de la placa base Legend-QDI PlatiniX 2D).
8. Conecte los periféricos internos IDE y las disqueteras mediante los cables de datos específicos a su placa base Legend-QDI PlatiniX 2D. Asegúrese que la orientación de los cables sea la correcta. (El cable rojo se corresponde con el pin 1).
9. Conecte los cables de la caja del ordenador a su placa base Legend-QDI PlatiniX 2D, como el conector de la fuente de alimentación (ATX, 3v, 12v), los testigos de corriente, y lectura de disco duro, interruptores de inicio y reset etc... (Consulte el apartado "Internal Connectors" en el manual de usuario de su placa base Legend-QDI PlatiniX 2D, desde la página 5 hasta la página 12). Después cierre la caja del ordenador.
10. Conecte los diferentes periféricos externos como el teclado PS/2, ratón PS/2, serie o USB, los dispositivos USB, el monitor y la impresora a la placa base Legend-QDI PlatiniX 2D. (Consulte el apartado "External Connectors" del manual de usuario de su placa base Legend-QDI PlatiniX 2D desde la página 9 hasta la página 10).
11. Cuando todo este integrado en configuración, vuelva a conectar su equipo a la red eléctrica.



Instalación del sistema:

1. Encienda su equipo mediante el interruptor de encendido de la caja.
2. Presione la tecla « Supr » para entrar en el menú de configuración de la BIOS.
3. Seleccione los valores de la Bios en concordancia con la configuración de su sistema (Nosotros le recomendamos que deje los valores establecidos por la Bios por defecto, para evitar posibles fallos que ocasionen que su sistema no funcione correctamente). Para más información las funciones de la Bios, consulte el apartado "BIOS Description" en el manual de usuario de la placa base Legend-QDI PlatiniX 2D, desde la página 26 hasta la página 45).
4. Presione la tecla « F10 » y seleccione la opción «Save & Exit Setup» en el menú de configuración de la Bios para guardar los cambios y reiniciar el sistema.
5. Instale el sistema operativo en el disco duro, no se olvide de seleccionar la secuencia de inicio correcta para que el sistema operativo pueda iniciarse.
6. Después de la instalación del sistema operativo, asegúrese que no hay conflictos con ningún dispositivo de su sistema.
7. Entonces, después del último paso, proceda a la instalación de los controladores de los diferentes dispositivos.

Un disco compacto con controladores de Legend-QDI esta incluido en el paquete de la placa base Legend-QDI PlatiniX 2D.

1. Instalación de los controladores

Usted puede instalar todos los controladores para su placa base facilmente. Tiene que instalar los controladores en el siguiente orden para un correcto funcionamiento del sistema, y es necesario reiniciar el equipo antes de finalizar la instalación de los controladores.

- | | |
|---------------------------------------|---|
| A. Chipset software | B. Network Driver ^(Opcional) |
| C. Audio Driver ^(Opcional) | D. DirectX |

2. Accesorios

- | | |
|-----------------------------|------------------|
| A. QDI ManageEasy(optional) | B. QDIStepEasyII |
| C. QDIRecoveryEasy | D. QDIBootEasy |
| E. Norton AntiVirus | |

A. QDI ManageEasy(optional) :»ManageEasy(optional)» es el software de control avanzado para Cliente/Servidor. ManageEasy(optional), tambien conocido como Legend QDI Desktop Manager (QDM) sirve como interface entre el usuario y hardware complejo. Es una herramienta eficaz para monitorizar la salud de su PC, proporcionando alertas locales y remotas de problemas potenciales en tiempo real, a nivel de PC individual o Red. ManageEasy(optional) le permite predecir posibles problemas de mecanismos como el disco duro, ventiladores, fuente de alimentación o temperatura.



- B. QDI StepEasyII** Con StepEasyII, Ud.(siempre bajo su responsabilidad, Qdi no se hace responsable de los daños ocasionados por la práctica de overclocking) puede escoger el reloj en pasos de 1MHz para la selección de la frecuencia de CPU core. Por ejemplo, una CPU de 800MHz puede configurarse para 801MHz, 802MHz, 803MHz.
- C. QDIRecoveryEasy** : Crea una “partición ‘imagen’” (mirror partition) de la partición activa de su disco duro, haciendo una copia de seguridad de todos los datos a esta “partición ‘imagen’”. Esta utilidad ideal proporciona herramientas para particionar su disco duro, copia de seguridad y recuperación de sus datos, copia de seguridad de la configuración de CMOS y utilidades de multi-arranque. RecoveryEasy es capaz de proteger su sistema de ataques de diferentes tipos de boot virus u otros tipos de virus dañinos como CIH. En caso de que su sistema se averíe, por error o por virus, se puede recuperar el sistema desde la partición ‘imagen’. Utiliza la tecnología incorporada en BIOS que no ocupa espacio ni en el disco duro ni en la memoria del sistema. Se trata de la mejor solución tanto para usuarios normales como para profesionales.
- D. QDI BootEasy** : BootEasy mejora el tiempo de proceso de arranque de ordenadores enormemente, reduciendo el tiempo de espera que el usuario debe sufrir al arrancar su ordenador.
- E. Norton Antivirus** : Versión trial 2001 de este conocido antivirus con la ventaja de ser actualizado via internet gracias a la aplicación LiveUpdate.

3. Navegue por el CD

Usted puede leer todos los documentos incluidos en este CD, incluidos Utility and Documents. Los ficheros incluidos en **Utility** son:

- A. Awdflash.exe
- B. Cblog.exe
- C. Lf.exe

Los ficheros incluidos en **Documents** son :

- A. Adobe Acrobat Reader V3.0 – Ar32e301.exe

PlatiniX 4X

Form Factor: ATX
CPU: Socket-423
Chipset: Intel 850
FSB: 400MHz
Memory: 4 PC800/PC600 RDRAM
IDE: ATA 100/66/33
AGP: 4x
I/O: 4 PCI/1 AGP/1 CNR
1 IrDA/4 USB

Optional:
Onboard AC'97 Audio

QDI Innovations:
SpeedEasy, BootEasy, LogoEasy,
ManageEasy, BIOS-ProtectEasy,
RecoveryEasy

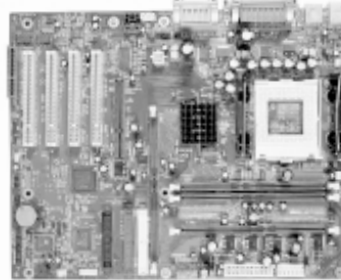

PlatiniX 1

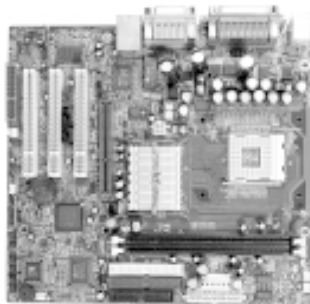

Form Factor: mATX
CPU: Socket-478
Chipset: Intel i845
FSB: 400MHz
Memory: 2 PC133 SDRAM
IDE: ATA 100/66/33
AGP: 4x
I/O: 3 PCI/1 AGP/1 CNR/
1 IrDA/4 USB

Optional:
Onboard AC'97 Audio
C-Media 6CH Hardware Audio
Onboard 100/10 Mb Ethernet

QDI Innovations:
SpeedEasy, BootEasy, LogoEasy,
ManageEasy, BIOS-ProtectEasy,
RecoveryEasy, StepEasy

Welcome to visit www.qdigrp.com for details



Motherboard Layout

Note:
The layout includes all options.
It is for your reference only.

 **Note:**

This manual is suitable for PlatiniX 2D series of mainboards. Each mainboard is carefully designed for the PC user who wants different features.

PlatiniX 2D: without ISA slot , onboard audio and LAN

PlatiniX 2DI: with ISA slot, without onboard audio and LAN

-A: with onboard audio

-L: with onboard LAN

-AL: with onboard audio and LAN

 **Caution**

Be sure to unplug the AC power supply before adding or removing expansion cards or other system peripherals, especially the memory devices, otherwise your mainboard or the system memory might be seriously damaged.

 **Caution**

Be sure to add some Silicone Grease between the CPU and the heatsink to keep them fully contacted to meet the heat sink requirement.

Item Checklist

The item checklist is only available for retail market. Completely check your package, If you discover damaged or missing items, contact your retailer.

- PlatiniX 2D series mainboard
- QDI Driver Utility CD
- 1 HD ribbon cable
- 1 FDD cable
- User's manual
- I/O shield(optional)
- 1 10-pin ribbon cable with bracket for USB3 and USB4(option)

Notice

The information in this document is subject to change in order to improve reliability, design, or function without prior notice and does not represent a commitment on the part of this company. In no event will we be liable for direct, indirect, special, incidental, or consequential damages arising out of the use or the possibility of such damages.

All trademarks are the property of their respective owners.

If you require further information, please visit our web-site: "www.qdigrp.com".