



Electronic Emission Notices

Federal Communications Commission (FCC) Statement (53142C)

This equipment has been tested and found to comply with the limits for a Class B digital device, pursuant to Part 15 of FCC Rules. These limits are designed to provide reasonable protection against harmful interference in a residential installation. This equipment generates, uses and can radiate radio frequency energy and, if not installed and used in accordance with instructions contained in this manual, may cause harmful interference to radio and television communications. However, there is no guarantee that interference will not occur in a particular installation.

If this equipment does cause harmful interference to radio or television reception, which can be determined by turning the equipment off and on, the user is encouraged to try to correct the interference by one or more of the following measures:

- REORIENT OR RELOCATE THE RECEIVING ANTENNA
- INCREASE THE SEPARATION BETWEEN THE EQUIPMENT AND THE RECEIVER
- CONNECT THE EQUIPMENT INTO AN OUTLET ON A CIRCUIT DIFFERENT FROM THAT OF THE RECEIVER
- CONSULT THE DEALER OR AN EXPERIENCED AUDIO/TELEVISION TECHNICIAN

NOTE: Connecting this device to peripheral devices that do not comply with Class B requirements, or using an unshielded peripheral data cable, could also result in harmful interference to radio or television reception.

The user is cautioned that any changes or modifications not expressly approved by the party responsible for compliance could void the user's authority to operate this equipment.

To ensure that the use of this product does not contribute to interference, it is necessary to use shielded I/O cables.

Copyright

This manual is copyrighted with all rights reserved. No portion of this manual may be copied or reproduced by any means.

While every precaution has been taken in the preparation of this manual, no responsibility for errors or omissions is assumed. Neither is any liability assumed for damages resulting from the use of the information contained herein.

Trademarks

All brand names, logos and registered trademarks mentioned are property of their respective owners.

Table of Contents

HARDWARE CONFIGURATION	3
Key Features	3
Motherboard Layout	5
Jumper Settings	6
CPU Speed Selection	6
J5 - On Board PCI Codec Sound	6
J6 - On Board AC97 Codec Sound	6
JBAT1 - CMOS Clear	6
SW3,SW4 - CPU Voltage Setting	7
Pin Assignment	8
HARDWARE SETUP	10
To Install DDR DIMMs	10
Installing a New Processor	11
To Install a Processor to ZIF Socket	11
Connect the Processor Fan Connector	11
Setting the Processor Speed	11
BIOS SETUP	12
Starting Setup	12
Main Menu	13
Standard CMOS Features	14
Advanced BIOS Features	15
Advanced Chipset Features	15
Integrated Peripherals	17
Power Management Setup	19
PNP/PCI Configurations	21
PC Health Status	21
Frequency/Voltage Control	21
Set Supervisor/User Password	21
Flash Update Procedure.....	22
APPENDIX	23
AC97 Sound Driver Installation for Windows NT 4.0/2000/XP	23
Onboard VGA Driver Installation for Windows NT 4.0/2000/XP	23

HARDWARE CONFIGURATION

Key Features :

Chipset

- VIA® P4X266/P4X266A/P4M266/P4X266E chipset.

Processor

- Support Intel® Pentium® 4 processors and the Northwood processors in the 478-pin package.
- Support Intel® Pentium® 4 processors system bus at 400MHz and 533MHz(only for P4X266E).

VRM 9.0 (Voltage Regulator Modules) on Board

- Flexible motherboard design with on board VRM 9.0.

System Memory

- A total of three 184-pin DDR SDRAM sockets.
- Support up to 3GB DRAMs (512Mb x8/x16 DRAM technology) for register and unbuffered DDR SDRAM module.
- Support DDR SDRAM memory types.
- 2.5V DRAM interface for DDR SDRAM.

System BIOS

- PnP, APM, ATAPI and Windows® 95/98/2000/XP.
- Full support of ACPI & DMI.
- Auto detects and supports LBA harddisks with capacities over 8.4GB.
- Easy to upgrade BIOS by end-user.

On-board I/O

- On board two PCI fast IDE ports supporting up to 4 ATA, ATA2 , Ultra ATA33/66/100/133 (for VT8233A chipset only) IDE HDDs, CD-ROMs, ZIP drives and LS-120 drives as boot drive.
- One ECP/EPP parallel port.
- Two 16550 Compatible UART serial ports.
- One floppy port supports two FDD of 360KB, 720KB, 1.2MB , 1.44MB and 2.88MB capacity.
- Six USB ports (four ports via two headers) only for VT8233 chipset, four USB ports (two ports via one header) only for VT8233A chipset.
- PS/2 keyboard connector.
- PS/2 mouse is supported.
- One Front Panel Sound Connector.
- Infrared (IrDA) is supported via a header.

Plug-and-Play

- Supports Plug and Play specification 1.1.
- Plug and Play for DOS, Windows® 3.X, Windows® 95/98/2000 as well as Windows® XP.
- Fully steerable PCI interrupts.

On-board AC97 Sound (optional)

- Integrated AC97 controller with standard AC97 Codec.
- Direct Sound and Sound Blaster compatible.
- Full-Duplex 16-bit record and play back.
- PnP and APM 1.2 support.
- Win® 95/98/2000/XP, NT drivers ready.
- Line-in, Line-out, Mic-in and MIDI/Game port.

On board VGA (only for P4M266)

- Integrates ProSavage DDR graphics accelerator.
- Brings mainstream graphics performance to the Value PC with leading-edge 2D, 3D and DVD video acceleration into a cost effective package.
- Combines AGP 4x performance with Microsoft DirectX texture compression and massive 2Kx2K textures to deliver unprecedented 3D performance and image quality.

On-board Creative PCI Sound (optional)

- PnP, creative 3D enhancement.
- Full-duplex, Sound Blaster 16 compatible.
- 128 voice wave table synthesizer.
- DOS game compatibility.
- PCI bus master for fast DMA.
- Fully compliant with AC97 power management specification.
- Win® 95, 98,2000,XP, NT drivers ready.
- Line-in, Line-out, Mic-in and MIDI/game port.

Note: *If this motherboard bundles a PCI sound function, so one slot cannot support bus master feature. If you find that your PCI card with bus master feature cannot work normally, please install the card on the other slots to avoid the conflict with the PCI sound.*

Power Management

- Supports SMM, APM and ACPI.
- Break switch for instant suspend/resume on system operations.
- Energy star "Green PC" compliant.
- Hardware monitoring circuit is supported, provide voltage, temperature, fan speed, etc. monitoring (optional).
- WOL (Wake-On-Lan) header support.
- External Modem Ring-in Wake-up support.
- Supports suspend-to-RAM(STR)(optional).

Expansion Slots

- 1 CNR slot (shares 1 PCI slot, only support CNR Audio)(optional).
- 1 AGP slot (support AGP 4X mode).
- 5 PCI bus master slots - ver. 2.1 compliant (1 PCI shares with CNR slot).

CAUTION

Static electricity can harm delicate components of the motherboard. To prevent damage caused by static electricity, discharge the static electricity from your body before you touch any of the computers electronic components.

Motherboard Layout

The following diagrams show the relative positions of the jumpers, connectors, major components and memory banks on the motherboard.

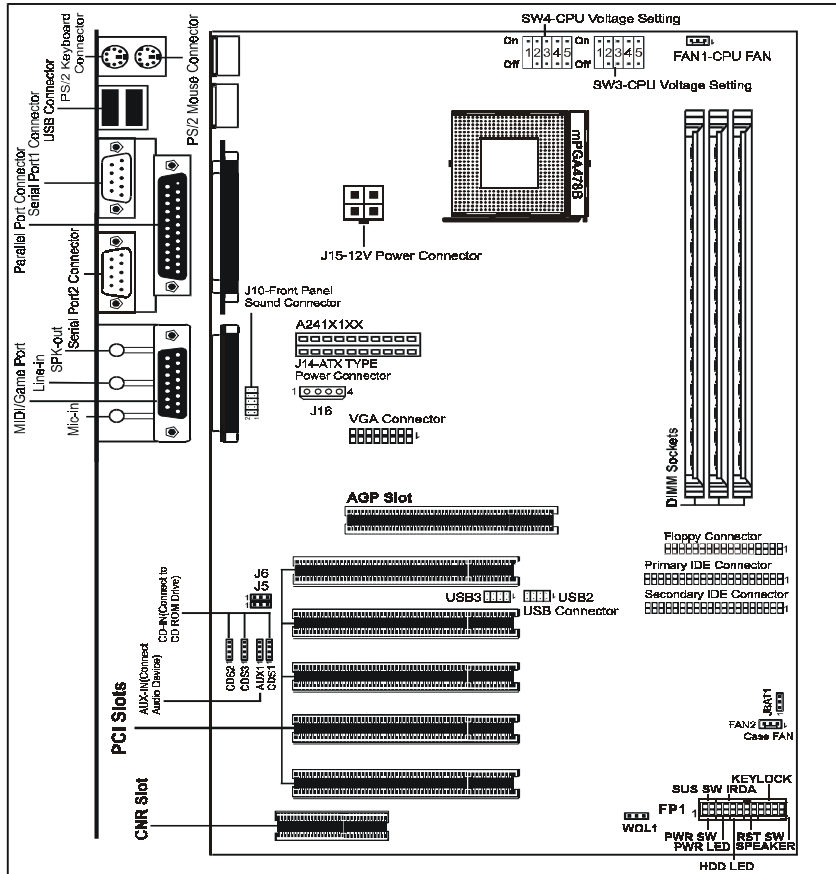

- # If you are using standard ATX power supply (without P4 12V power connector), you MUST connect a peripheral power plug (the plug supplying power to HDD / CDROM) into J16. Thus you can use either ATX 12V power supply or standard ATX power supply for this motherboard (Noted : NOT all kinds of standard ATX power supply are guaranteed to be applicable in this motherboard.).
- # The VGA Connector is only for P4M266 Chipset.
- # USB3-USB Connector is only for VT8233 Chipset.

NOTE

- 1) Be sure to check the cable orientation in order to match the colored strip to the pin 1 end of the connector.
- 2) When you start up the system, please wait for 5 seconds after you power on AC.
- 3) It is not recommended to add a metal spacer plate on the back of the Socket478. Otherwise, some components will be short and damaged.

Jumper Settings

This chapter explains how to configure the motherboard's hardware. Before using your computer, make sure all jumpers and DRAM modules are set correctly. Refer to this chapter whenever in doubt.

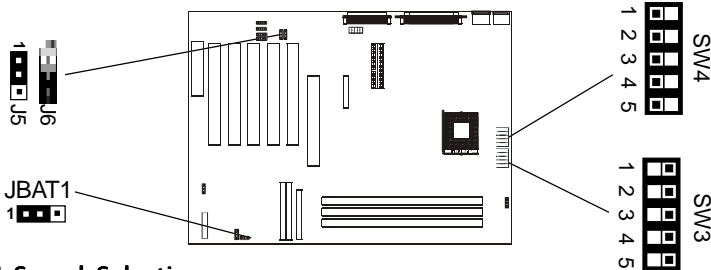

CPU Speed Selection

In this motherboard, jumperless feature is implemented such that no jumper is required to be set for different type of CPU installed.

Notice:

1. Be sure to save the CMOS setting when exit the CMOS.
2. The CPU is frequency multiplier locked, no CPU speed change will be seen even if the frequency multiplier setting in CMOS setup is changed.

J5 – On Board PCI Codec Sound

J5	Function
2-3	PCI Sound Disable
1-2*	PCI Sound Enable*

J6 – On Board AC97 Codec Sound

J6	Function
1-2	AC97 Sound Disable
2-3*	AC97 Sound Enable*

CNR Sound Card can only be used with On Board AC97 Codec Sound Disabled.

JBAT1 – CMOS Clear

JBAT1	Selection
1-2*	Normal*
2-3	CMOS Clear



Close















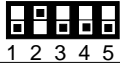



















Open

* = Default setting.







SW3,SW4 – CPU Voltage Setting

SW3 ON & SW4 OFF, CPU Voltage Setting by CPU; SW3 OFF,
CPU Voltage Setting is manual.

SW4[1:5]	CPU Voltage	SW4[1:5]	CPU Voltage
 *	Off *		1.475
	1.100		1.500
	1.125		1.525
	1.150		1.550
	1.175		1.575
	1.200		1.600
	1.225		1.625
	1.250		1.650
	1.275		1.675
	1.300		1.700
	1.325		1.725
	1.350		1.750
	1.375		1.775
	1.400		1.800
	1.425		1.825
	1.450		1.850

 On  Off * =Default setting.

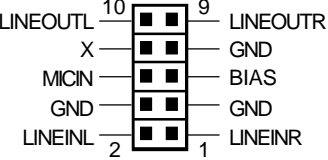
Pin Assignment

Internal Audio Connector																			
AUX1 : AUX-IN 	<table border="0"> <thead> <tr> <th>Pin</th> <th>Assignment</th> </tr> </thead> <tbody> <tr> <td>1</td> <td>AUX-L</td> </tr> <tr> <td>2</td> <td>GND</td> </tr> <tr> <td>3</td> <td>GND</td> </tr> <tr> <td>4</td> <td>AUX-R</td> </tr> </tbody> </table>	Pin	Assignment	1	AUX-L	2	GND	3	GND	4	AUX-R								
Pin	Assignment																		
1	AUX-L																		
2	GND																		
3	GND																		
4	AUX-R																		
CDS1 : CD-IN 	<table border="0"> <thead> <tr> <th>Pin</th> <th>Assignment</th> </tr> </thead> <tbody> <tr> <td>1</td> <td>CD-L</td> </tr> <tr> <td>2</td> <td>GND</td> </tr> <tr> <td>3</td> <td>GND</td> </tr> <tr> <td>4</td> <td>CD-R</td> </tr> </tbody> </table>	Pin	Assignment	1	CD-L	2	GND	3	GND	4	CD-R								
Pin	Assignment																		
1	CD-L																		
2	GND																		
3	GND																		
4	CD-R																		
CDS2 : CD-IN 	<table border="0"> <thead> <tr> <th>Pin</th> <th>Assignment</th> </tr> </thead> <tbody> <tr> <td>1</td> <td>CD-R</td> </tr> <tr> <td>2</td> <td>GND</td> </tr> <tr> <td>3</td> <td>CD-L</td> </tr> <tr> <td>4</td> <td>GND</td> </tr> </tbody> </table>	Pin	Assignment	1	CD-R	2	GND	3	CD-L	4	GND								
Pin	Assignment																		
1	CD-R																		
2	GND																		
3	CD-L																		
4	GND																		
CDS3 : CD-IN 	<table border="0"> <thead> <tr> <th>Pin</th> <th>Assignment</th> </tr> </thead> <tbody> <tr> <td>1</td> <td>GND</td> </tr> <tr> <td>2</td> <td>CD-L</td> </tr> <tr> <td>3</td> <td>GND</td> </tr> <tr> <td>4</td> <td>CD-R</td> </tr> </tbody> </table>	Pin	Assignment	1	GND	2	CD-L	3	GND	4	CD-R								
Pin	Assignment																		
1	GND																		
2	CD-L																		
3	GND																		
4	CD-R																		
USB Connector 	<table border="0"> <thead> <tr> <th>Pin</th> <th>Assignment</th> </tr> </thead> <tbody> <tr> <td>1</td> <td>VCC</td> </tr> <tr> <td>2</td> <td>GND</td> </tr> <tr> <td>3</td> <td>USBP1-</td> </tr> <tr> <td>4</td> <td>USBP0+</td> </tr> <tr> <td>5</td> <td>USBP1+</td> </tr> <tr> <td>6</td> <td>USBP0-</td> </tr> <tr> <td>7</td> <td>GND</td> </tr> <tr> <td>8</td> <td>VCC</td> </tr> </tbody> </table>	Pin	Assignment	1	VCC	2	GND	3	USBP1-	4	USBP0+	5	USBP1+	6	USBP0-	7	GND	8	VCC
Pin	Assignment																		
1	VCC																		
2	GND																		
3	USBP1-																		
4	USBP0+																		
5	USBP1+																		
6	USBP0-																		
7	GND																		
8	VCC																		
J10 Front Panel Sound Connector																			
																			
J16 	<table border="0"> <thead> <tr> <th>Pin</th> <th>Assignment</th> </tr> </thead> <tbody> <tr> <td>1</td> <td>12V</td> </tr> <tr> <td>2</td> <td>GND</td> </tr> <tr> <td>3</td> <td>GND</td> </tr> <tr> <td>4</td> <td>VCC</td> </tr> </tbody> </table>	Pin	Assignment	1	12V	2	GND	3	GND	4	VCC								
Pin	Assignment																		
1	12V																		
2	GND																		
3	GND																		
4	VCC																		

FP1
FRONT PANEL HEADER
 HEADER 2x12

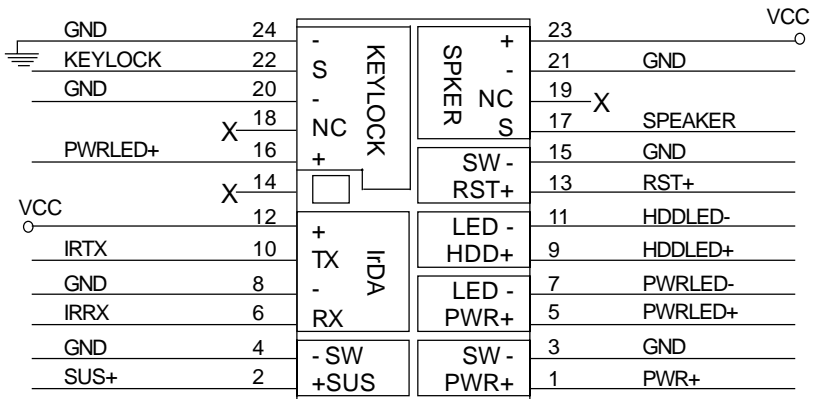

Hardware Setup

To Install DDR DIMMs

1. Locate the DDR DIMM sockets.
2. Holding the DDR DIMM by the edges, remove it from its antistatic package.
3. Make sure the clips at either end of the socket are pushed away from the socket.

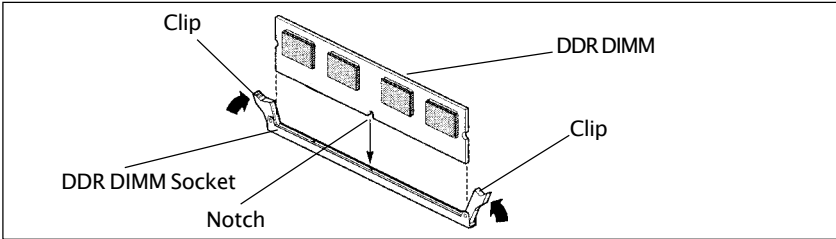

4. Position the DDR DIMM above the socket. Align the notch in the bottom edge of the DDR DIMM with the keys in the socket.
5. Insert the bottom edge of the DDR DIMM into the socket.
6. When the DDR DIMM is seated, push down on the top edge of the DDR DIMM until the retaining clips at the ends of the socket snap into place. Make sure the clips are firmly in place.



Please turn off system before installing and removing any device, otherwise you'll cause the system damage.

CAUTION

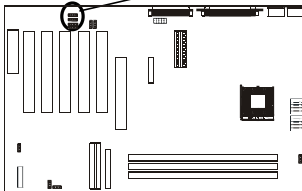

Checking the mounting post of your computer

Please check your computer chassis if it is carrying any metal mounting post at this location.

Remove the mounting post or add insulation to the post before putting in the motherboard.

Installing a New Processor

An upgrade processor can dramatically increase general system speed and performance.

Most microprocessor upgrade kits include the following items:

- Microprocessor chip
- Installation instructions and technical data

Before installing the processor, please refer to the installation notes that available with the CPU package.

To Install a Processor to ZIF Socket

To install the processor, follow these steps:

1. If the system microprocessor is already on the motherboard socket, you need to remove it from the motherboard socket. The socket is a Zero Insertion Force (ZIF) socket which has a metal arm at one side. Carefully grasp this arm, move it horizontally away from the socket and lift it up. Eventually you will be able to lift the chip straight up out of the socket. Be careful not to bend any pins.

Be careful not to bend any of the pins when removing the microprocessor chip from its socket. The microprocessor chip can be permanently damaged.

2. Unpack the new microprocessor chip.
3. Carefully align the processor with the correct orientation to the socket on the motherboard.
4. Carefully insert the processor into the socket, and move the metal arm downward to replace it in its original position.

Connect the Cooling Fan Connector

The CPU should always have a Heat Sink and cooling fan attached to prevent overheating.

Please follow the setup to install the Heat Sink and cooling fan. Then connect the processor fan cable to the fan connector that located on the motherboard near the processor and ensure the fan can operate. Otherwise the CPU can overheat and cause ***damage to both CPU and motherboard.***

Setting the Processor Speed

After you install the processor into the motherboard, set the processor speed by CMOS setup.

BIOS Setup

This chapter discusses Award's Setup Program built into the ROM BIOS. The Setup Program allows users to modify the basic system configuration. This special information is then stored in battery-backed RAM, which retains the setup information when the power is turned off.

Starting Setup

The Award BIOS is immediately activated when you turn on the computer. The BIOS reads the system information contained in the CMOS and begins the process of checking out the system and configuring it. When it finishes, the BIOS will seek an operating system on one of the disks and then launch and turn control over to the operating system.

While the BIOS is in control, the Setup Program can be activated :

1. By pressing immediately after switching the system on, or
2. By pressing the key when the following message appears briefly at the bottom of the screen during the POST (Power On Self Test)

Press DEL to enter SETUP

If the message disappears before you can respond and you still wish to enter Setup, restart the system to try again by turning it OFF then ON or pressing the "RESET" button on the system case. You may also restart by simultaneously pressing the <Ctrl>, <Alt>, and <Delete> keys. If you do not press the keys at the correct time and the system does not reset, an error message will be displayed and you will again be asked to ...

PRESS F1 TO CONTINUE, DEL TO ENTER SETUP

Getting Help

Press F1 to pop up a small help window that describes the appropriate keys to use and the possible selections for the highlighted item. To exit the Help Window press <Esc> or the F1 key again.

In Case of Problems

If, after making and saving system changes with the Setup Program, you discover that your computer does not reset, use the Award BIOS defaults to override the CMOS settings.

Main Menu

Once you enter the Award BIOS CMOS Setup Utility, the Main Menu will appear on the screen. The Main Menu allows you to select from various setup functions and two exit choices. Use the arrow keys to select among the items and press <Enter> to accept and enter the sub-menu.

Phoenix - AwardBIOS CMOS Setup Utility	
<ul style="list-style-type: none"> ▶ Standard CMOS Features ▶ Advanced BIOS Features ▶ Advanced Chipset Features ▶ Integrated Peripherals ▶ Power Management Setup ▶ PnP/PCI Configurations ▶ PC Health Status 	<ul style="list-style-type: none"> ▶ Frequency/Voltage Control Load Fail-Safe Defaults Load Optimized Defaults Set Supervisor Password Set User Password Save & Exit Setup Exit Without Saving
Esc : Quit ↑↓←→ : Select Item F10 : Save & Exit Setup	
Time, Date, Hard Disk Type	

(Note : The figures of BIOS Setup Menu included here only show a typical case, and may not be exactly the same as the one on your unit.)

Note that a brief description of each highlighted item will appear at the bottom of the screen.

Standard CMOS Features This setup page includes all the items of Award™ special standard features.

Advanced BIOS Features This setup page includes all the items of Award™ special enhanced features.

Advanced Chipset Features This setup page includes all the items of chipset special features.

Integrated Peripherals This section page includes all the items of IDE hard drive and Programmed Input / Output features.

Power Management Setup This entry only appears if your system supports Power Management "Green PC" standards.

PnP/PCI Configurations This entry appears if your system supports PNP/PCI.

PC Health Status Display CPU and Case Fan Speed.

Frequency/Voltage Control CPU speed setting are settings of CPU speed. You should refer to your CPU marking.

Load Fail-Safe Defaults The BIOS defaults have been set by the manufacturer and represent settings which provide the minimum requirements for your system to operate.

Load Optimized Defaults The chipset defaults are settings which provide for maximum system performance. While Award has designed the custom BIOS to maximize performance, the manufacturer has the right to change these defaults to meet its needs.

Set Supervisor/ User Password Changes, sets, or disables password. It allows you to limit access to the system and the Setup Program.

Save & Exit Setup Saves value changes to CMOS and exits setup.

Exit Without Saving Abandons all CMOS value changes and exits setup.

Standard CMOS Features

The items in Standard CMOS Setup Menu are divided into 10 categories. Each category includes one or more setup items. Use the arrow keys to highlight the item and then use the <PgUp> or <PgDn> key to select the desired value in each item.

Phoenix - AwardBIOS CMOS Setup Utility
Standard CMOS Features

Date (mm :d :yy)	Mon. May 21 2001	Item Help
Time (h h :mm:ss)	11 : 1 : 35	
▶ IDE Primary Master	[Press Enter 4303 MB]	Menu Level ▶
▶ IDE Primary Slave	[None]	Change the day, month, year and century
▶ IDE Secondary Master	[None]	
▶ IDE Secondary Slave	[None]	
Drive A	[1.44M, 3.5 in.]	
Drive B	[None]	
Video	[EGA/VGA]	
Halt on	[All Errors]	
Base Memory	640K	
Extended Memory	30720K	
Total Memory	31744K	

↑↓↔← : Move Enter : Select +/-/PU/PD : Value F10 : Save ESC : Exit F1 : General Help
F5 : Previous Values F6 : Fail-Safe Defaults F7 : Optimized Defaults

(Note : The figures of BIOS Setup Menu included here only show a typical case, and may not be exactly the same as the one on your unit.)

Date The date format is <day-of-the-week>. <month> <day> <year>.

Time The time format is <hour> <Minute> <second> displayed in 24-hour military-time clock. For example, 1 p. m. is displayed as 13:00:00.

IDE Primary Master/Slave IDE Secondary Master/Slave	These categories identify the types of the two channels that have been installed in the computer. If the controller of the HDD interface is SCSI, the selection shall be "None".
Drive A / Drive B	This category identifies the types of floppy disk drive A or drive B that has been installed in the computer.
Video	The default setting is EGA/VGA.
Halt on	You can select which type of error will cause the system to halt.

Advanced BIOS Features

This section allows you to configure your system for basic operation. You have the opportunity to select the boot-up sequence, keyboard operation, shadowing and security.

Advanced Chipset Features

This section allows you to configure DRAM clock, DRAM timing, AGP mode etc.

The following figure is the details of **Advanced Chipset Features**.

Phoenix - AwardBIOS CMOS Setup Utility
Advanced Chipset Features

▶ DRAM Clock/Drive Control	[Press Enter]	Item Help
▶ AGP & P2P Bridge Control	[Press Enter]	Menu Level ▶
▶ CPU & PCI Bus Control	[Press Enter]	
Memory Hole	[Disabled]	
System BIOS Cacheable	[Disabled]	
Video RAM Cacheable	[Disabled]	

↑↓→← : Move Enter : Select +/-/PU/PD : Value F10 : Save ESC : Exit F1 : General Help
F5 : Previous Values F6 : Fail-Safe Defaults F7 : Optimized Defaults

This section includes 3 pieces of hierarchical submenu.

- ▶ DRAM Clock/Drive Control Select DRAM clock, time, cycle length etc.
- ▶ AGP & P2P Bridge Control Select AGP aperture size, AGP mode etc.
- ▶ CPU & PCI Bus Control Select the way of CPU & PCI bus control. It must be stated that these items should not be altered. The default settings have been chosen because they provide the best operating conditions for your system.

The following figure is the details of **DRAM Clock/Drive Control**.

Phoenix - AwardBIOS CMOS Setup Utility
DRAM Clock/Drive Control

Current FSB Frequency [100MHz] Current DRAM Frequency [100MHz] DRAM Clock [By SPD] DRAM Timing [By SPD] SDRAM Cycle Length [3] Bank Interleave [Disabled] DRAM Command Rate [2T Command]	Item Help <hr/> Menu Level ▶ ▶
--	-----------------------------------

↑↓→← : Move Enter : Select +/-/PU/PD : Value F10 : Save ESC : Exit F1 : General Help
 F5 : Previous Values F6 : Fail-Safe Defaults F7 : Optimized Defaults

The following figure is the details of **AGP & P2P Bridge Control**.

Phoenix - AwardBIOS CMOS Setup Utility
AGP & P2P Bridge Control

AGP Aperture Size [64M] AGP Mode [4X] AGP Driving Control [Auto] x AGP Driving Value DA AGP Fast Write [Disabled] AGP Master 1 WS Write [Disabled] AGP Master 1 WS Read [Disabled]	Item Help <hr/> Menu Level ▶ ▶
--	-----------------------------------

↑↓→← : Move Enter : Select +/-/PU/PD : Value F10 : Save ESC : Exit F1 : General Help
 F5 : Previous Values F6 : Fail-Safe Defaults F7 : Optimized Defaults

The following figure is the details of **CPU & PCI Bus Control**.

Phoenix - AwardBIOS CMOS Setup Utility
CPU & PCI Bus Control

CPU to PCI Write Buffer	[Enabled]	Item Help
PCI Master 0 WS Write	[Enabled]	Menu Level ▶ ▶
PCI Delay Transaction	[Disabled]	

↑↓→← : Move Enter : Select +/-PU/PD : Value F10 : Save ESC : Exit F1 : General Help
F5 : Previous Values F6 : Fail-Safe Defaults F7 : Optimized Defaults

Integrated Peripherals

The Integrated Peripherals Setup allows the user to configure the onboard IO, IRQ, DMA assignment etc.

The following figure is the details of **Integrated Peripherals**.

Phoenix - AwardBIOS CMOS Setup Utility
Integrated Peripherals

▶ VIA OnChip IDE Device	[Press Enter]	Item Help
▶ VIA OnChip PCI Device	[Press Enter]	Menu Level ▶
▶ VIA SuperI/O Device	[Press Enter]	
Init Display First	[PCI Slot]	
OnChip USB Controller	[All Enabled]	
USB Keyboard Support	[Disabled]	
IDE HDD Block Mode	[Disabled]	

↑↓→← : Move Enter : Select +/-PU/PD : Value F10 : Save ESC : Exit F1 : General Help
F5 : Previous Values F6 : Fail-Safe Defaults F7 : Optimized Defaults

This section includes 3 pieces of hierarchical submenu.

- ▶ VIA OnChip IDE Device Configure the onboard IDE controller and DMA assignment.
- ▶ VIA OnChip PCI Device Configure onchip AC97 audio, MC97 modem and LAN controller.
- ▶ VIA SuperIO Device Configure floppy disk controller, printer port, serial port, game port and MIDI port.

The following figure is the details of **VIA OnChip IDE Device**.

Phoenix - AwardBIOS CMOS Setup Utility
VIA OnChip IDE Device

OnChip IDE Channel0	[Enabled]	Item Help
OnChip IDE Channel1	[Enabled]	Menu Level ▶ ▶
IDE Prefetch Mode	[Disabled]	
Primary Master	PIO [Auto]	
Primary Slave	PIO [Auto]	
Secondary Master	PIO [Auto]	
Secondary Slave	PIO [Auto]	
Primary Master	UDMA [Auto]	
Primary Slave	UDMA [Auto]	
Secondary Master	UDMA [Auto]	
Secondary Slave	UDMA [Auto]	

↑↓→← : Move Enter : Select +/-/PU/PD : Value F10 : Save ESC : Exit F1 : General Help
 F5 : Previous Values F6 : Fail-Safe Defaults F7 : Optimized Defaults

The following figure is the details of **VIA OnChip PCI Device**.

Phoenix - AwardBIOS CMOS Setup Utility
VIA OnChip PCI Device

VIA-3058 AC97 Audio	[Auto]	Item Help
VIA-3068 MC97 Modem	[Disabled]	Menu Level ▶ ▶

↑↓→← : Move Enter : Select +/-/PU/PD : Value F10 : Save ESC : Exit F1 : General Help
 F5 : Previous Values F6 : Fail-Safe Defaults F7 : Optimized Defaults

The following figure is the details of **VIA SuperI/O Device**.

Phoenix - AwardBIOS CMOS Setup Utility
VIA SuperI/O Device

	Item Help
Onboard FDC Controller	[Enabled]
Onboard Serial Port 1	[Auto]
Onboard Serial Port 2	[Auto]
UART Mode Select	[Normal]
UR2 Duplex Mode	[Half]
Onboard Parallel Port	[378/IRQ7]
Parallel Port Mode	[SPP]
ECP Mode Use DMA	[3]
Game Port Address	[201]
Midi Port Address	[330]
Midi Port IRQ	[10]
Menu Level ▶ ▶	

↑↓→← : Move Enter : Select +/-PU/PD : Value F10 : Save ESC : Exit F1 : General Help
F5 : Previous Values F6 : Fail-Safe Defaults F7 : Optimized Defaults

Power Management Setup

The Power Management Setup Menu allows you to configure your system to most save energy while operating in a manner consistent with your own style of computer use.

The following figure is the details of **Power Management Setup**.

Phoenix - AwardBIOS CMOS Setup Utility
Power Management Setup

	Item Help
ACPI function	[Disabled]
Power Management Option	[User Define]
HDD Power Down	[Disabled]
Suspend Mode	[Disabed]
Video Off Option	[Suspend -> Off]
Video Off Method	[V/H SYNC+Blank]
MODEM Use IRQ	[3]
Soft-Off by PWRBTN	[Instant-Off]
▶ IRQ/Event Activity Detect	[Press Enter]
Menu Level ▶	

↑↓→← : Move Enter : Select +/-PU/PD : Value F10 : Save ESC : Exit F1 : General Help
F5 : Previous Values F6 : Fail-Safe Defaults F7 : Optimized Defaults

This section includes 1 piece of hierachical submenu.

- ▶ IRQ/Event Activity Detect IRQ activity monitoring and Event activity setting.

The following figure is the details of **IRQ/Event Activity Detect**.

Phoenix - AwardBIOS CMOS Setup Utility
IRQ/Event Activity Detect

VGA	[OFF]	Item Help
LPT & COM	[LPT/COM]	Menu Level ▶ ▶
HDD & FDD	[ON]	
PCI Master	[OFF]	
PowerOn by PCI Card	[Disabled]	
Modem Ring Resume	[Disabled]	
RTC Alarm Resume	[Disabled]	
x Date (of Month)	0	
x Resume Time (hh:mm:ss)	16 : 0 : 0	
▶ IRQs Activity Monitoring	[Press Enter]	

↑↓→← : Move Enter : Select +/-/PU/PD : Value F10 : Save ESC : Exit F1 : General Help
F5 : Previous Values F6 : Fail-Safe Defaults F7 : Optimized Defaults

The following figure is the details of **IRQs Activity Monitoring**.

Phoenix - AwardBIOS CMOS Setup Utility
IRQs Activity Monitoring

Primary INTR	[ON]	Item Help
IRQ3 (COM 2)	[Enabled]	Menu Level ▶ ▶ ▶
IRQ4 (COM 1)	[Enabled]	
IRQ5 (LPT 2)	[Enabled]	
IRQ6 (Floppy Disk)	[Enabled]	
IRQ7 (LPT 1)	[Enabled]	
IRQ8 (RTC Alarm)	[Disabled]	
IRQ9 (IRQ2 Redir)	[Disabled]	
IRQ10 (Reserved)	[Disabled]	
IRQ11 (Reserved)	[Disabled]	
IRQ12 (PS/2 Mouse)	[Enabled]	
IRQ13 (Coprocessor)	[Enabled]	
IRQ14 (Hard Disk)	[Enabled]	
IRQ15 (Reserved)	[Disabled]	

↑↓→← : Move Enter : Select +/-/PU/PD : Value F10 : Save ESC : Exit F1 : General Help
F5 : Previous Values F6 : Fail-Safe Defaults F7 : Optimized Defaults

PnP/PCI Configurations

This section describes how to configure the PCI bus system. This section covers some very technical items and it is recommended that only experienced users should make any changes to the default settings.

PC Health Status

The PC Health Status display CPU and Case Fan Speed.

Frequency/Voltage Control

This section allows you to set CPU Speed.

Set Supervisor/User Password

You can set either supervisor or user password, or both of them. The difference between them are:

Supervisor Password :	You can enter the Setup Program and change the options of the setup menus.
User Password :	You can enter the Setup Program but can not change the options of the setup menus.

When you select this function, the following message will appear at the center of the screen to assist you in creating a password.

ENTER PASSWORD:

Type the password, up to eight characters in length, and press<Enter>. The new password will clear the previously entered password from the CMOS memory. You will be asked to confirm the password. Type the password again and press <Enter>. You may also press <Esc> to abort the selection and operate without a password.

To disable a password, just press <Enter> when you are prompted to enter the password. A message will be displayed to confirm that the password is disabled.

PASSWORD DISABLED.

Once the password is disabled, the system will reset and you can enter the Setup Program freely.

When a password is enabled, you will be prompted to enter it every time you try to enter setup. This prevents an unauthorized person from changing any setting of your system configuration.

In addition, when a password is enabled, you can require the BIOS to request a password every time your system is rebooted. This would further prevent unauthorized use of your computer.

The password requirement is defined by the Security Option of the BIOS Features Setup Menu. If the Security Option is set to "System", the password will be required both at resetting and at entering setup. If the option is set to "Setup", the prompt only appears when you try to enter setup.

Flash Update Procedure

A program AWDFLASH.EXE is included in the utility diskette or CD (X:\Utility\AWDFLASH.EXE). The user is recommended to follow the procedure below to update the flash BIOS.

(X: your CD driver letter).

1. Create a DOS-bootable floppy diskette. Copy the new BIOS file (just obtained or downloaded) and the utility program AWDFLASH.EXE to the diskette.
2. Allow the PC system to boot from the DOS diskette.
3. At the DOS prompt, key in

AWDFLASH
and hit <ENTER>

4. Enter the file name of the new BIOS.
5. The question: "Do you want to save BIOS (Y/N)" is displayed.

Key in "N" if there is no need to save the existing BIOS content..
Key in "Y" if a backup copy of the existing BIOS is needed.
(A file name has to be assigned to the existing BIOS binary file.)

6. The question : "Are you sure to program (Y/N)" is displayed.

Key in "Y"

7. Wait until the flash-update is completed.
8. Power down the PC system.
9. Restart the PC.

Warning:

DO not turn off or RESET the computer during the flash process.

If you are unsure how to upgrade the BIOS, it is best to take your computer to an Authorized Service Center and have a trained technician do the work for you.

APPENDIX

AC97 Sound Driver Installation for Windows NT 4.0/2000/XP

Please follow the step to install AC97 Sound Driver for Windows NT 4.0/2000/XP.

(Note : This manual assumes that your CD-ROM device drive letter is D:.)

D:\VIA Chipset\AC97_8233

Onboard VGA Driver Installation for Windows NT 4.0/2000/XP

Please follow the step to install Onboard Driver for Windows NT 4.0/2000/XP.

(Note : This manual assumes that your CD-ROM device drive letter is D:.)

D:\VIA Chipset\VGA_P4M266

