

# Quick Installation Chart

For your convenience, this chart lists all the CPUs supported by P2/370A-V and their corresponding jumper setting.

CPU Model		Ratio	JF0	JF1	JF2	JF3
300/100	200/66	3.0x	1-2	2-3	1-2	1-2
350/100	233/66	3.5x	1-2	2-3	2-3	1-2
400/100	266/66	4.0x	2-3	1-2	1-2	1-2
450/100	300/66	4.5x	2-3	1-2	2-3	1-2
500/100	333/66	5.0x	2-3	2-3	1-2	1-2
550/100	366/66	5.5x	2-3	2-3	2-3	1-2
600/100	400/66	6.0x	1-2	1-2	1-2	2-3
650/100	433/66	6.5x	1-2	1-2	2-3	2-3
700/100	466/66	7.0x	1-2	2-3	1-2	2-3
750/100	500/66	7.5x	1-2	2-3	2-3	2-3
800/100	533/66	8.0x	2-3	1-2	1-2	2-3

\*\*\* The Ratio of some latest CPUs are fixed by Intel, such as Celeron 366, 400... etc. You can ignore the four jumpers if you have this CPU on board and it will be auto detected by motherboard. Please check with the CPU manufacturer or vendor for the CPU Ratio information.

\*\*\* The CPU CLK over specification operation is optional, please see session 3.4.11 for more information.

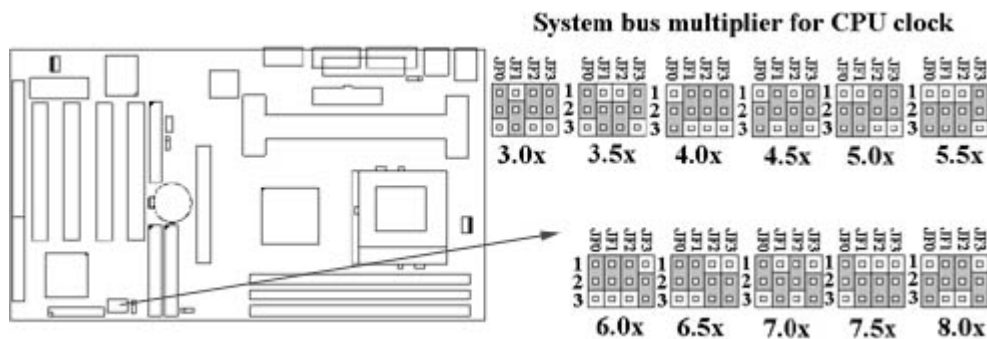

# P2/370A-V Motherboard User's Manual

Product Name: P2/370A-V

Manual Revision: English, 1.1

**Trademarks**

Intel, Socket 370, Celeron, Pentium II and Pentium III are trademarks of Intel Corporation  
Award is a trademark of Award Software International Inc.  
MS-DOS, Windows 95, Windows 98 and Windows NT are registered trademarks of Microsoft Corporation  
Novell is a trademark of Novell Corporation  
Sound Blaster SB16 is a trademark of Creative Technology  
ESS and Solo-1 are trademarks of ESS Technology, Inc.  
All other brand and product names are trademarks or registered trademarks of their respective companies.

## **Table of Contents**

### **Chapter 1. Introduction**

- 1.1 Product Overview
- 1.2 Features
- 1.3 Specifications
- 1.4 Content
- 1.5 System Board Layout

### **Chapter 2. Hardware Setup**

#### 2.1 Installation Procedure

- 2.1.1 Jumper Settings
- 2.1.2 Enable/Disable Sound
- 2.1.3 Clearing the CMOS
- 2.1.4 CPU Voltage Setting
- 2.1.5 CPU Frequency Selection
- 2.1.6 CPU FSB Frequency Setting

#### 2.2 Installation of CPU

- 2.2.1 For Celeron, Pentium II & III CPU
- 2.2.2 For Socket 370 CPU

#### 2.3 Installation of Memory

- 2.3.1 Installation of 168-pin DIMM
- 2.3.2 Removal of 168-pin DIMM
- 2.3.3 Memory Configuration

#### 2.4 I/O Connections/Panel Connections

- 2.4.1 ATX Power Connector
- 2.4.2 CPU Fan Connector
- 2.4.3 Infrared Connector
- 2.4.4 Wake-up on LAN Connector
- 2.4.5 Floppy Disk Drive Connector
- 2.4.6 Primary/Secondary IDE Connector
- 2.4.7 PS/2 Mouse Port
- 2.4.8 PS/2 Keyboard Connector
- 2.4.9 Serial Port
- 2.4.10 Printer Port
- 2.4.11 USB Connectors
- 2.4.12 Line Out Connector (optional)
- 2.4.13 Line In Connector (optional)
- 2.4.14 Microphone In Connector (optional)
- 2.4.15 Game/MIDI Port (optional)
- 2.4.16 ATAPI IDE/SONY Audio (optional)
- 2.4.17 Mitsumi Audio (optional)
- 2.4.18 Panel Connection

### **Chapter 3. BIOS Setup**

- 3.1 CMOS Setup Utility
- 3.2 Standard CMOS Setup
- 3.3 BIOS Features Setup
- 3.4 Chipset Features Setup
- 3.5 Power Management Setup
- 3.6 PNP/PCI Configuration Setup
- 3.7 Integrated Peripherals
- 3.8 Load BIOS Defaults
- 3.9 Load Setup Defaults
- 3.10 Supervisor/User Password
- 3.11 IDE HDD Auto Detection
- 3.12 Exit CMOS Setup Utility

## Chapter 4. Sound Driver Installation

- 4.1 Windows 95 Installation
- 4.2 Windows 98 Installation
- 4.3 Windows NT 4.0 Installation
- 4.4 AudioRack32 Installation

## Chapter 1. Introduction

### 1.1 Product Overview

Thank you for purchasing the **P2/370A-V** motherboard. This motherboard utilizes **VIA**'s latest technology, namely **VT82C693 AGPset** chipset. We have conducted a motherboard compatibility test with a variety of hardware and software, such as CPUs, memory, display cards, CD ROMs, Novell, MS Office ....etc and compliance with Year 2000.

We have set high standards on our quality control, with absolute confidence, we believe this product is the wisest choice.

This manual is composed of four sections. The first section is the introduction of this motherboard, and the second section explains the proper procedure to setup the motherboard, the third section provides information on how to setup the CMOS. The last section states the sound driver installation .

### 1.2 Features

- Support Desktop Management Interface (DMI) through BIOS.
- Support Accelerated Graphics Port (AGP) cards for high performance.
- Modem Remote Ring On.
- Wake up on LAN.
- RTC Wake Up Alarm: Program the date/time to wake up your system.
- Support NCR SCSI BIOS.
- Support Advanced Configuration Power Interface (ACPI).
- BIOS Green feature function, and 2Mbits "Plug & Play" Flash ROM.
- ESS 1938S Solo-1 PCI Sound on board (optional).

### 1.3 Specifications

- CPU :** - Supports Intel Celeron, Pentium II, Pentium III with 66/100 FSB Processors
- Chipset :** - VIA VT82C693 and VT82C596 chipset
- DIMM :** - Supports 3.3V EDO or SDRAM in 3 168-pin banks, each bank consists of 1x168-pin 64-bit DIMM socket, which can support memory sizes of 8/16/32/64/128/256 MB modules.  
- Supports up to a maximum of 768 MB system memory
- IDE :** - Dual channel PIO and PCI Bus Master IDE ports support up to 4 EIDE devices for HDD or CD-ROM

- Supports PIO Mode 4 with data transfer rate up to 14 MB/Sec
- Supports Ultra DMA 33 (UDMA) with data transfer rate up to 33 MB/Sec
- BIOS** :
  - 2Mbits Award BIOS V.4.51 with built-in Anti-Virus, DMI support, and green function (Plug-and-Play BIOS)
  - Supports CD-ROM, SCSI, and LS120/ZIP boot up
  - Support NCR SCSI BIOS.
- I/O Devices** :
  - One FDD control port supports two of the 5.25" or 3.5" floppy drives up to 2.88 MB.
  - Two high-speed 16550 UART compatible serial ports
  - One parallel ports with ECP/ EPP compatibility.
  - One PS/2 mouse port
  - One PS/2 Keyboard connector
- IR Port** :
  - One IrDA/ASKIR compatible Infrared interface port. (Cable optional)
- USB Ports** :
  - Two Universal Serial Bus (USB) ports support up to 127 peripheral devices.
- Sound** : (optional)
  - ESS Solo-1 ES1938S PCI Sound Chip
  - Built-in 3D audio effects processor
  - Full native DOS games compatibility, via three technologies TDMA, DDMA & PC/PCI
  - High quality ESFM music synthesizer
  - Dynamic range (SNR) over 80db
  - Record, compress and playback voice, sound and music
  - Full-Duplex operation for simultaneous record and playback
  - Stereo inputs from line in, Auxiliary A (CD audio) and Auxiliary B and a mono input from microphone
  - MPU-401 interface for wavetable synthesizer and MIDI devices
  - Integrated dual game port
  - Support PC games and application for Sound Blaster and Sound Blaster pro
  - Support Microsoft Windows Sound System
  - Meet PC 97/98 and WHQL specifications
  - Sample record/playback rates up to 48KHz
- ATX Power** :
  - Supports Modem remote Ring-On function
  - Supports software power off function
  - Supports RTC Wake-Up.
  - Supports Wake up on LAN.
- Expansion Slots** :
  - Four 32-bit PCI expansion slots
  - One 16-bit ISA expansion slot
  - One 32-bit AGP expansion slot
- Operating System** :
  - Supports Windows 95/98, Windows NT, MS-DOS V. 6.22, OS/2, Novell, Unix, SCO UNIX.....
- Dimension** :
  - 305 mm x 170 mm ATX Form factor

## 1.4 Content

The motherboard box contains the following items:

- One Motherboard
- One IDE Ribbon Cable
- One Floppy Ribbon Cable
- One Retention mechanism
- One Driver CD

- User's Manual & Quick Installation Chart

## 1.5 MotherBoard Layout

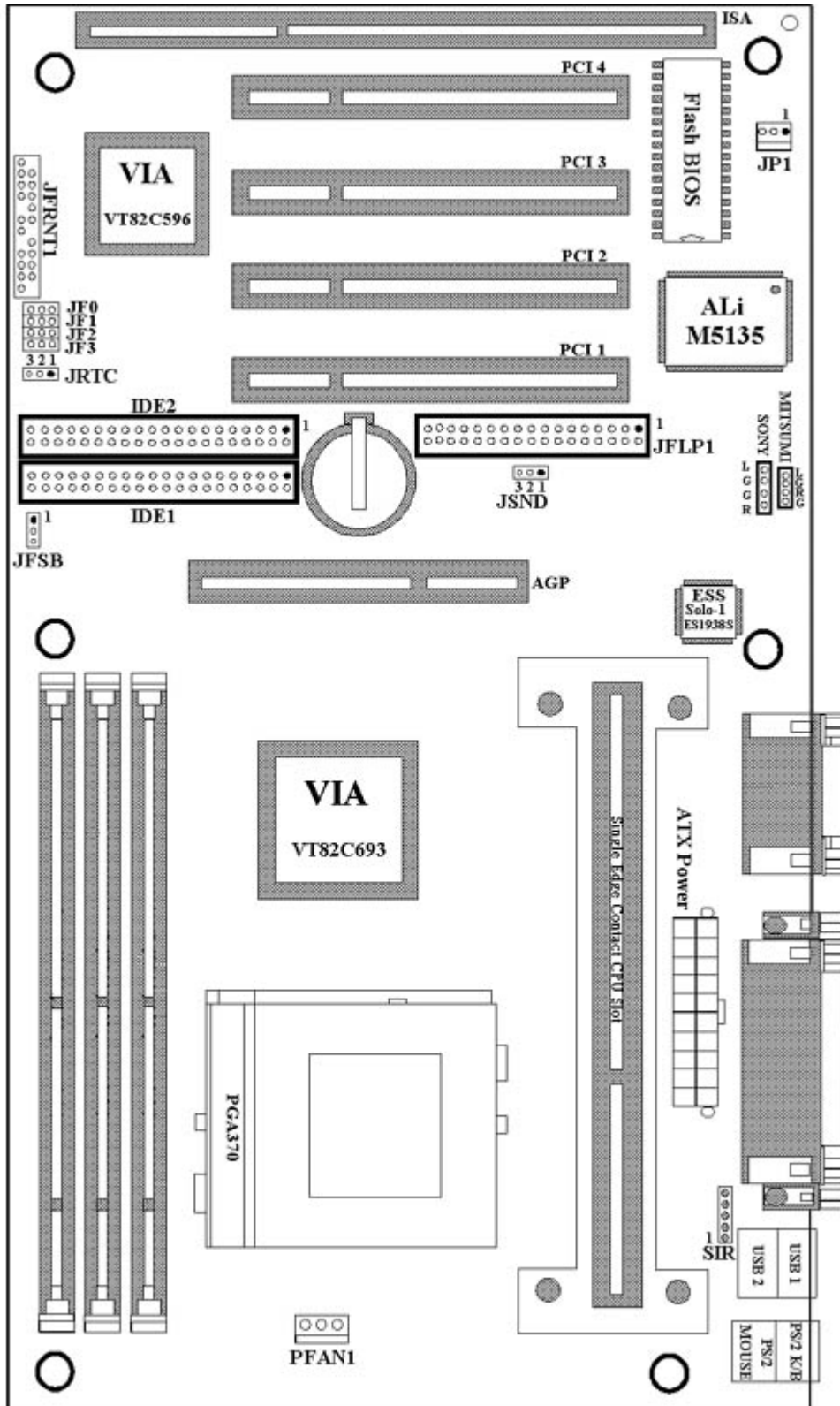

## Chapter 2. Hardware Setup

### 2.1 Installation Procedure

1. Jumper settings
2. Installation of CPU
3. Installation of Memory
4. I/O Connections & Panel Connections

### 2.1.1 Jumper Settings

In this manual , **(1-2) represents the first and second pins of the jumper. (2-3) represents the second and third pins of the jumper.** On the motherboard, you will see two sets of jumpers with different color jumper caps:

- Yellow Jumper Caps : Sets the Function of Flash CMOS  
JRTC
- Green Jumper Caps : Sets the type and speed of CPU  
JF0, JF1, JF2, JF3
- Red Jumper Caps : Sets the FSB frequency of CPU JFSB  
Enable/Disable Sound function JSND (optional)

**WARNING:** Electronic parts are Static sensitive. To prevent damage to the computer and its parts please take the following measures.

- Work on a surface such as concrete, linoleum or hard wood floor.
- Ground your self with either a properly installed grounding strap or by touching a major electrical appliance long enough to discharge the static.

### 2.1.2 Enable/Disable Sound (JSND : Red Jumper Cap) (The Sound function and jumper are optional)

This jumper lets you to enable or disable the sound function.

- 1-2 : Enable Sound function (Default Setting)  
2-3 : Disable Sound function

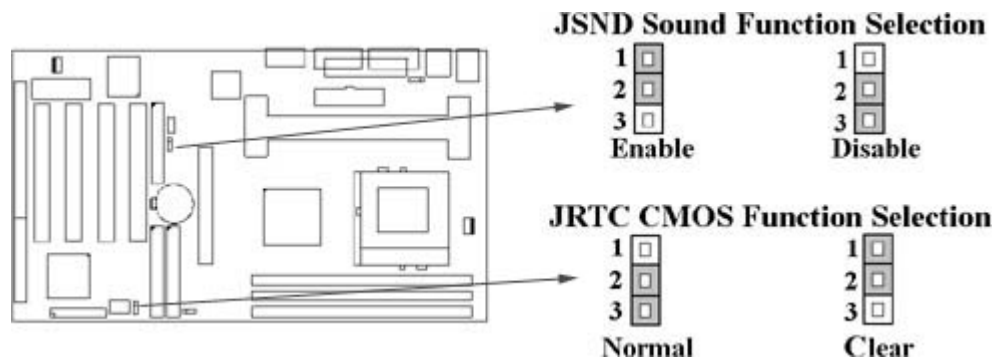

### 2.1.3 Clearing the CMOS (Yellow Jumper Caps)

JRTC: CMOS Function Selection

- 1-2 : Clear data  
2-3 : Normal Operation (Default Setting)

How to Clear the CMOS Setting

1. Turn off the power.
2. Remove ATX power cable from connector J1.
3. Remove Yellow Jumper Cap from JRTC (2-3) and put on JRTC (1-2) to remove the CMOS setting.
4. Remove Yellow Jumper Cap from JRTC (1-2) and put on JRTC (2-3).
5. Connect ATX power cable back to connector J1.
6. Turn on the power.
7. While the system reboots, press <DEL> key to set the BIOS setup.

### 2.1.4 CPU Voltage Setting

The motherboard supports CPU VID function, the CPU core voltage is automatically detected, the range is from 1.3V to 3.5V for Pentium II & III CPU and. the range is from 1.3V to 2.0V for Socket 370 & Celeron CPU

### 2.1.5 CPU Frequency Selection (Green Jumper Caps)

CPU Model	Ratio	JF0	JF1	JF2	JF3
300/100	200/66	3.0x	1-2	2-3	1-2
350/100	233/66	3.5x	1-2	2-3	2-3
400/100	266/66	4.0x	2-3	1-2	1-2
450/100	300/66	4.5x	2-3	1-2	2-3
500/100	333/66	5.0x	2-3	2-3	1-2
550/100	366/66	5.5x	2-3	2-3	2-3
600/100	400/66	6.0x	1-2	1-2	2-3
650/100	433/66	6.5x	1-2	1-2	2-3
700/100	466/66	7.0x	1-2	2-3	2-3
750/100	500/66	7.5x	1-2	2-3	2-3
800/100	533/66	8.0x	2-3	1-2	2-3

The Ratio of some latest CPUs are fixed by Intel, such as Celeron 366, 400... etc. You can ignore the four jumpers if you have this CPU on board and it will be auto detected by motherboard. Please check with the CPU manufacturer or vendor for the CPU Ratio information.

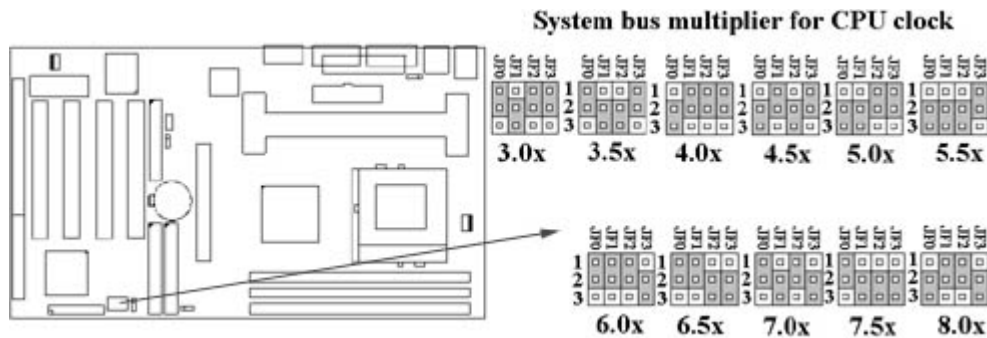

### 2.1.6 CPU FSB Frequency Setting (Red Jumper Caps)

The JFSB jumper provides three FSB frequency settings for the CPU. Auto Detect , 66MHz or 100MHz FSB frequency can be selected with this jumper. The 100MHz FSB frequency setting is over specification operation for 66MHz FSB CPU . The over specification operation is not recommended.

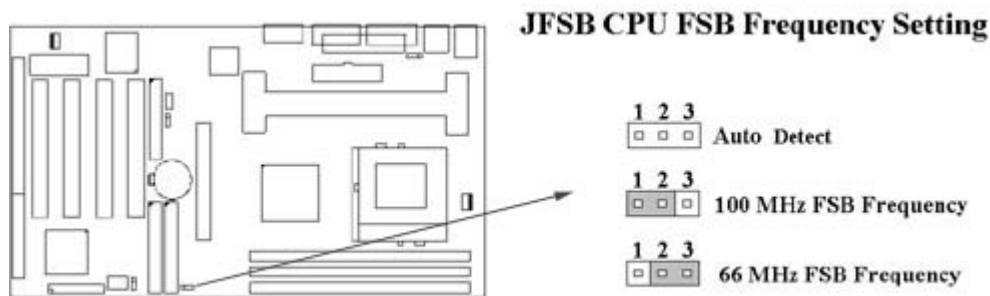

## 2.2 Installation of CPU

### 2.2.1 For Celeron, Pentium II & III CPU

The motherboard provides a Single Edge Contact(SEC)slot for processor packaged in an SEC cartridge. Follow these steps to install CPU:

**Mount the Universal Retention Mechanism (URM) & Insert the CPU:** ( The illustration is just for reference )

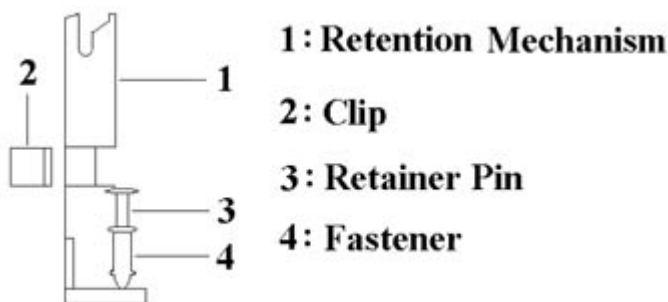

This URM was designed to accommodate 3 types of CPU Form Factor. ( SECC, SECCII & SEPP ). For Example : Pentium II & Celeron family.

**Note :** Please put a soft pad under M/B before the installation of URM.

Installation for SECC CPU :

1. Leave space below each mounting hole for the fastener to protrude through the hole.
2. Position URM on the M/B next to the slot1 connector.
3. Push down retainer pin into respective fastener to secure URM onto the M/B.
4. Push CPU into URM to contact with slot1.
5. Make sure latching portion of CPU engaged with windows ledge of URM.

Installation for SECC II or SEPP CPU :

1. Same as step (1) of SECC.
2. Same as step (2) of SECC.
3. Same as step (3) of SECC.
4. Same as step (4) of SECC.
5. Snap in 2 clips into side windows of URM to secure SEPP CPU.

If there is a fan on the CPU, Please plug in the fan cable to the three pin fan connector on the motherboard (PFAN1).

## 2.2.2 For Socket 370 CPU

Before installing CPU, make sure the power is off. Locate the level bar on the PGA370 ZIF socket. Push level bar away from the socket and pull upward 90 degrees. Insert the CPU into the socket. Make sure the notch of the CPU corresponds with the white dot on the ZIF socket (the corner without pin socket). Do not push in the CPU. Make sure all pins are aligned with the CPU socket. ON the level bar.

## 2.3 Installation of Memory

Motherboard has 3x168-pin 64-bit Dual Inline Memory Module (DIMM) sockets divided into 3 banks. You can install 3.3V Extended Data Output (EDO) or Unbuffered Synchronous DRAM (SDRAM) memory. This will increase the system reliability.

### 2.3.1 Installation of 168-pin DIMM (Dual Inline Memory Module)

1. Before inserting the DIMM, make sure the pin1 of the DIMM matches with the pin1 on the DIMM socket.
2. Insert DIMM into the DIMM sockets at a 90-degree angle and press down.

### 2.3.2 Removal of 168-pin DIMM

1. Press the holding clips on both sides of the socket outward to release the DIMM.



2. Gently pull the DIMM out of the socket.

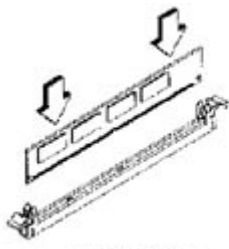

Install DIMM

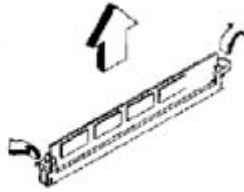

Remove DIMM

### 2.3.3 Memory Configuration

There is no jumper setting required for the memory size or type. It is automatically detected by the system BIOS, and the total memory size is to add them together.

<i>DIMM Socket</i>	<i>DIMM Modules</i>
<b>DIMM1</b>	EDO/SDRAM 8, 16, 32, 64, 128, 256MB
<b>DIMM2</b>	EDO/SDRAM 8, 16, 32, 64, 128, 256MB
<b>DIMM3</b>	EDO/SDRAM 8, 16, 32, 64, 128, 256MB

### 2.4 I/O Connections/Panel Connections

#### I/O Connections

- J1 ATX Power Connector
- PFAN1 CPU fan connector
- SIR Infrared Connector ( Cable optional )
- JP1 Wake up on LAN connector
- JFLP1 Floppy Disk Drive Connector
- IDE1, 2 Primary/ Secondary IDE Connectors
- MS PS/2 Mouse Port
- KB PS/2 Keyboard Connector
- JCOM1, 2 Serial Ports 1 & 2
- JPRT Printer Port
- USB1, 2 USB Connector
- P1 Game/MIDI Connectors (optional)
- LOUT Line out Connector (optional)
- LIN Line in Connector (optional)
- MIC Microphone in Connector (optional)
- MITSUMI The Connector for Mitsumi CD-ROM audio cable (optional)
- SONY The Connector for IDE/Sony CD-ROM audio cable (optional)

#### 2.4.1 ATX Power Connector (20-pin J1)

Make sure that the power supply is off before connecting or disconnecting the power cable.

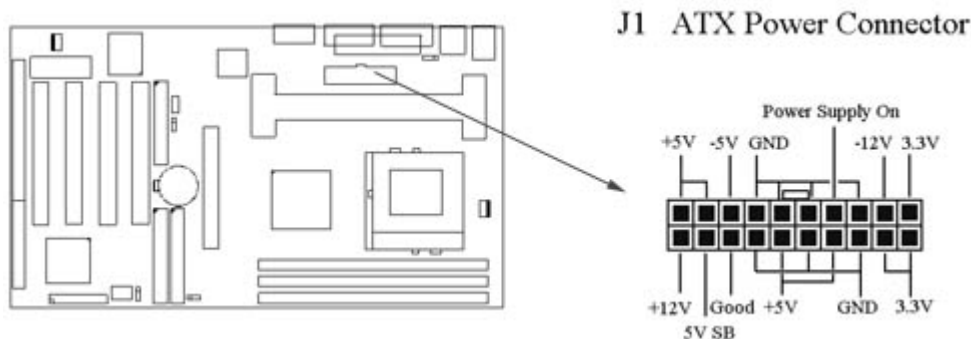

### 2.4.2 CPU Fan Connector (3-pin PFAN1)

Connect the fan's plug to the board taking into consideration the polarity of the connector.

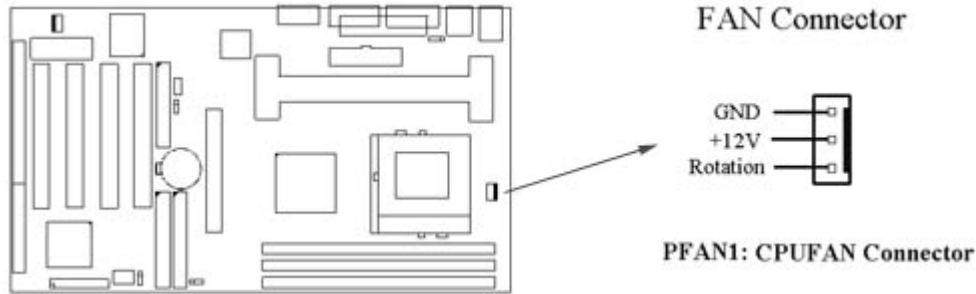

### 2.4.3 Infrared Connector (5-pin SIR)

This connector supports the optional wireless transmitting and receiving infrared module, with this module and application software such as Laplink or Win95 Direct Cable Connection, user can transfer files to or from their laptops, notebooks, PDA, PCs and printers. The connector supports IrDA (115.2Kbps, 2 meters) and ASK-IR (56Kbps). Install infrared module onto Infrared connector and configure the setting through "UART Mode Select" in Integrated Peripherals to select whether UART is directed for use with COM2 or Infrared.

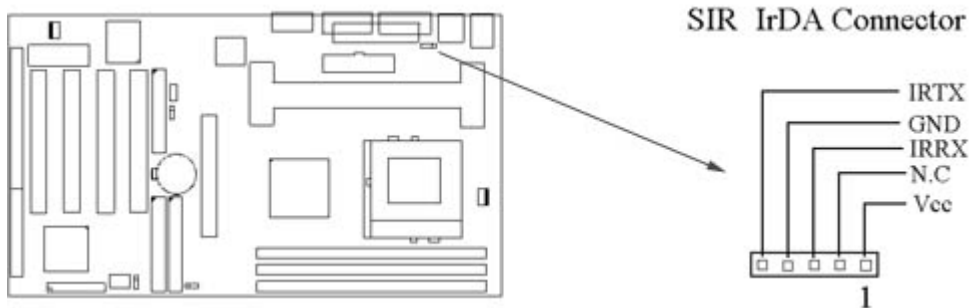

### 2.4.4 Wake-up on LAN Connector (3-pin JP1)

The JP1 connector powers up the system when a wakeup packet or signal is received from the network. This feature requires the Wake up on LAN function in BIOS is set to Enabled and that your system has an ATX power supply with at least 720mA +5V standby power.

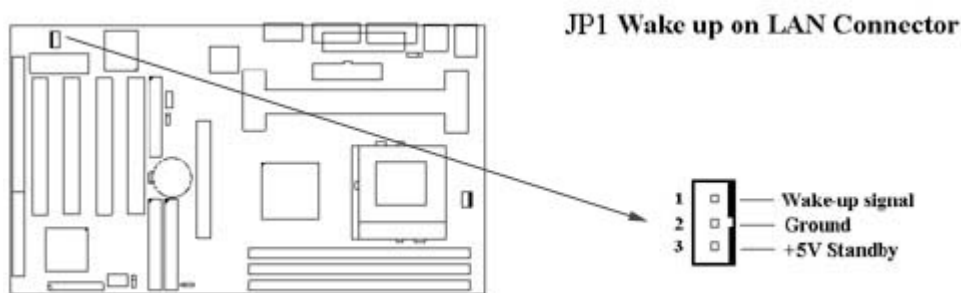

### 2.4.5 Floppy Disk Drive Connector (34-pin JFLP1)

This connector supports the provided floppy disk drive ribbon cable. Orient the red stripe to pin 1

#### JFLP1 Floppy Drive Connector

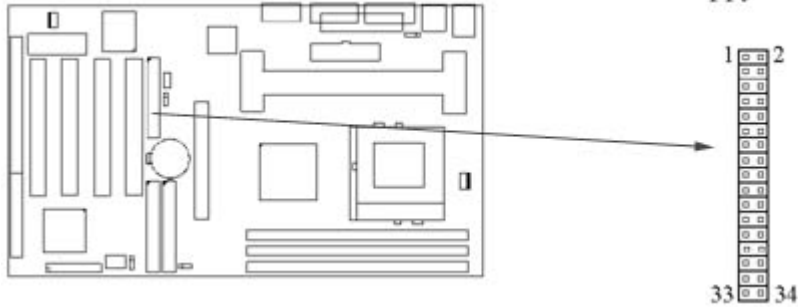

#### 2.4.6 Primary/Secondary IDE Connector (Two 40-pin IDE)

These connectors support the provided IDE hard disk ribbon cable. Connect your first IDE hard disk to master mode of the primary channel. If you have second IDE device to install in your system, connect it as slave mode on the same channel, and the third and fourth device can be connected on secondary channel as master and slave mode respectively.

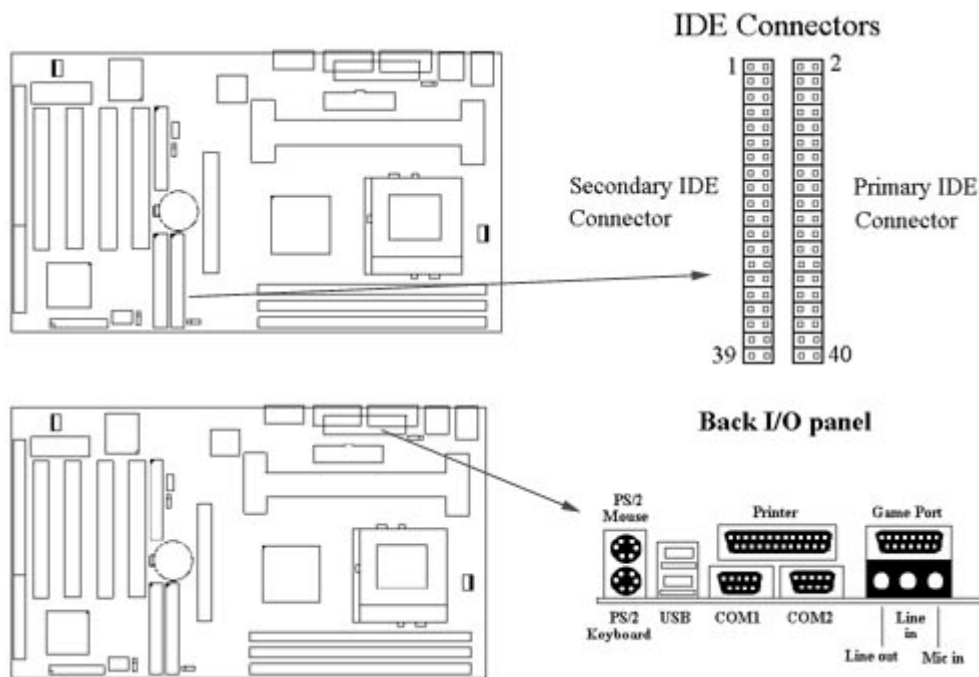

#### 2.4.7 PS/2 Mouse Port (6-pin Mini-Din MS)

The system will direct IRQ12 to the PS/2 mouse.

#### 2.4.8 PS/2 Keyboard Connector (6-pin Mini-Din KB)

This connection is for a standard keyboard using a PS/2 plug. You may use a Din to Mini-Din adapter on standard AT keyboards.

#### 2.4.9 Serial Port (Two 9-pin D-type JCOM)

#### 2.4.10 Printer Port (25-pin D-type JPRT)

You can enable the parallel port and choose the IRQ through the “Onboard Parallel Port” setting in Integrated Peripherals of the COMS SETUP UTILITY.

#### 2.4.11 USB Connectors (Two 4-pin USB)

You can attach USB devices to the USB connector.

#### 2.4.12 Line Out Connector (optional)

The Line Out phonejack provides the audio outputs for the left and right stereo channels.

#### 2.4.13 Line In Connector (optional)

The Line In phonejack is used to attach monaural or stereo devices such as a cassette, Digital Audio Tape, or Minidisc players for playback, mixing, or recording.

#### 2.4.14 Microphone In Connector (optional)

The Microphone In phonejack is used to attach a monaural microphone for live audio input for playback, mixing, or recording.

#### 2.4.15 Game/MIDI Port (optional)

The Game/MIDI Port connector is used to attach a joystick for game interaction or to attach an external MIDI device for playback, mixing, or recording.

#### 2.4.16 ATAPI IDE/Sony CD-ROM Audio (4-pin SONY) (optional)

The ATAPI IDE/Sony CD-ROM Audio connector is used to connect the audio cable from either an ATAPI IDE or Sony CD-ROM drive for playback, mixing, and recording.

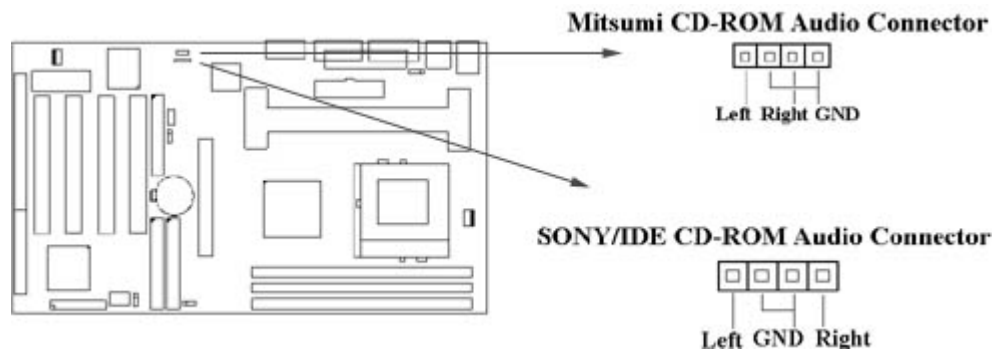

#### 2.4.17 Mitsumi CD-ROM Audio (4-pin MITSUMI) (optional)

The Mitsumi CD-ROM Audio connector is used to connect the audio cable from a Mitsumi CD-ROM drive for playback, mixing, or recording. Only one of the two CD-ROM audio connectors may be used at a time.

#### 2.4.18 Panel Connection (24-pin JFRNT)

JFRNT Connector	Function
GREENLED	Suspend Mode LED
PWRLED	Power LED
KEYLK	Keylock Switch
SPKR	Speaker
RESET	Reset Switch
IDELED	HDD LED
PWRBNT	ATX Power Button Connector
SMISW	Sleep Switch

**WARNING:** To avoid the system from failing, turn off the power before connecting any devices to the system.

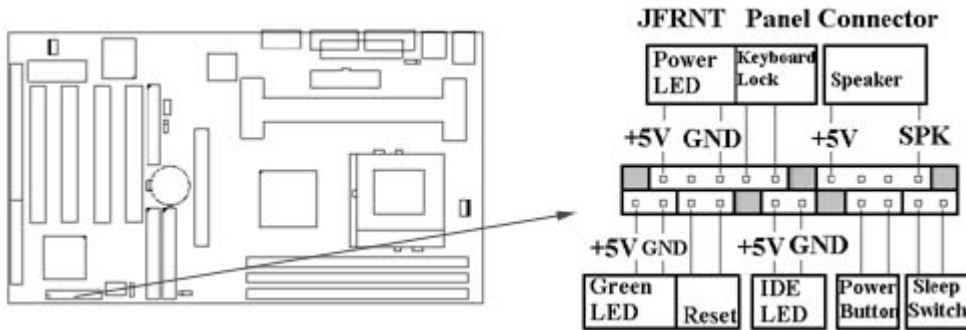

## Chapter 3. BIOS Setup

### 3.1 CMOS Setup Utility

To activate CMOS Setup, press <DEL> key immediately after you turn on the system. The following message “Press DEL to enter SETUP” should appear in the lower left hand corner of your screen.

When you enter the CMOS Setup Utility, the Main Menu will be displayed (Figure 3-1). You can use arrow keys to select your function, press <Enter> key to accept the selection and enter the sub-menu.

Figure 3-1. CMOS Setup Utility Main Screen

ROM PCI/ISA BIOS (XXXXXXXX)  
 CMOS SETUP UTILITY  
 AWARD SOFTWARE, INC.

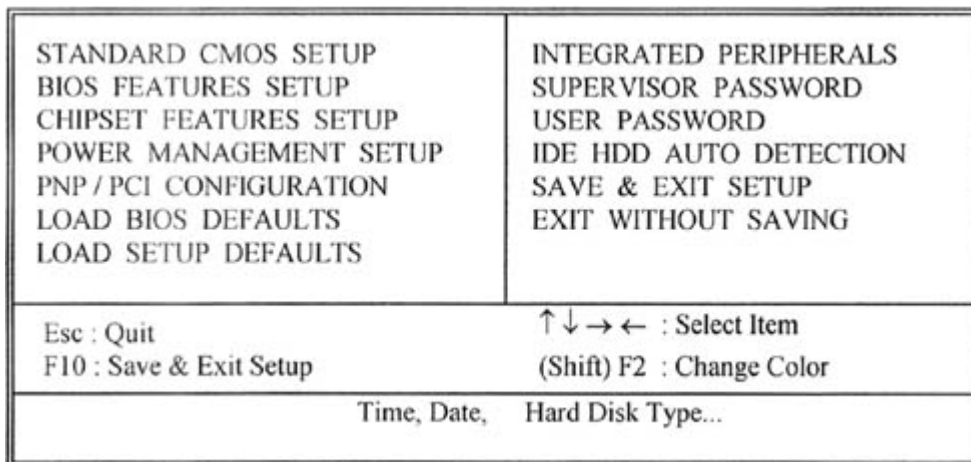

### 3.2 Standard CMOS Setup

With the sub-menu (Figure 3-2), you can setup the; system date, system time, hard and floppy drive type, and display adapter type. Please refer to your equipment specification when changing the setup. Use arrow keys to highlight items, and use <PageUp> <PageDown> <+>, or <-> keys to scroll through the available options.

Figure 3-2. Standard CMOS Setup Screen

ROM PCI/ISA BIOS (XXXXXXXX)  
 STANDARD CMOS SETUP  
 AWARD SOFTWARE, INC.

Date (mm:dd:yy) : Wed, Dec 10 1997																			
Time(hh:mm:ss) : 17 : 52 : 00																			
<b>HARD DISKS</b>	<b>TYPE</b>	<b>SIZE</b>	<b>CYLS</b>	<b>HEAD</b>	<b>PRECOMP</b>	<b>LANDZ</b>	<b>SECTOR</b>	<b>MODE</b>											
Primary Master	: Auto	0	0	0	0	0	0	AUTO											
Primary Slave	: Auto	0	0	0	0	0	0	AUTO											
Secondary Master	: Auto	0	0	0	0	0	0	AUTO											
Secondary Slave	: Auto	0	0	0	0	0	0	AUTO											
Drive A	: 1.44M , 3.5in.																		
Drive B	: None																		
Video	: EGA / VGA																		
Halt On	: All Errors																		
					<table border="1"> <tr> <td>Base Memory</td> <td>: 640K</td> </tr> <tr> <td>Extended Memory</td> <td>: 31744K</td> </tr> <tr> <td>Other Memory</td> <td>: 384K</td> </tr> <tr> <td colspan="2"><hr/></td> </tr> <tr> <td>Total Memory</td> <td>: 32768K</td> </tr> </table>					Base Memory	: 640K	Extended Memory	: 31744K	Other Memory	: 384K	<hr/>		Total Memory	: 32768K
Base Memory	: 640K																		
Extended Memory	: 31744K																		
Other Memory	: 384K																		
<hr/>																			
Total Memory	: 32768K																		
ESC : Quit			↑ ↓ → ← : Select Item			PU / PD / + / - : Modify													
F1 : Help			(Shift) F2 : Change Color																

### 3.2.1 Date

To assign the system date, the format is “mm.dd.yy”. The input range for the Month is 1-12. Range for Date is 1-31. Range for Year is 1994-2079. System BIOS will calculate the day of the week automatically.

### 3.2.2 Time

To assign the system time, the format is “hh:mm:ss”. The setting is in military time. When entering 2:34pm enter “14:34:00”.

### 3.2.3 Hard Disks Setting

The BIOS supports Dual-Channel PIO and PCI Bus Master IDE ports. Each port supports one master and one slave hard drive. You can use <PageUp> or <PageDown> key to change hard drive type. Incorrect setting may result in boot up error or system hang.

If your hard disk drive is not listed, you can select Type “USER” to define your own drive manually. We recommend that you select Type “AUTO” for all drives. The BIOS will auto-detect the hard disk drive and CD-ROM drive at the POST stage.

If your hard disk drive is a SCSI device, please select “None” for your hard drive setting.

### 3.2.4 Floppy Drives A&B Setting

Select your floppy disk drive type. Options are 360KB (5.25”), 720KB (3.5”), 1.2MB (5.25”), 1.44MB (3.5), 2.88MB (3.5”).

### 3.2.5 Video Display Adapter Setting

Select the display adapter type for your system. Options are EGA/VGA, MONO, CGA40 and CGA80.

### 3.2.6 Halt On

This function allows the system to halt when an error is detected during Power-On Self-Test.

## 3.3 BIOS Features Setup

The sub-menu (Figure 3-3) includes all AWARD enhanced functions. The correct setting can enhance boot up efficiency. You can assign system speed, setup sequence, typematic and system password setting. You can enter <F1> key for help on highlighted topics. If you want to restore values before the changes you just made, press <F5> key. If you want to restore default value, press <F6> or <F7> key.

**Figure 3-3. BIOS FEATURES SETUP SCREEN**

ROM PCI / ISA BIOS (XXXXXXXX)  
 BIOS FEATURES SETUP  
 AWARD SOFTWARE, INC.

Virus Warning	: Disabled	Video BIOS Shadow	: Enabled
CPU Internal Cache	: Enabled	C8000-CBFFF Shadow	: Disabled
External Cache	: Enabled	CC000-CFFFF Shadow	: Disabled
CPU L2 Cache ECC Checking	: Enabled	D0000-D3FFF Shadow	: Disabled
Processor Number Feature	: Disabled	D4000-D7FFF Shadow	: Disabled
Quick Power On Self Test	: Enabled	D8000-DBFFF Shadow	: Disabled
Boot Sequence	: C, A, SCSI	DC000-DFFFF Shadow	: Disabled
Swap Floppy Drive	: Disabled		
Boot Up Floppy Seek	: Disabled		
Boot Up Numlock Status	: On		
Gate A20 Option	: Fast		
Memory Parity/ECC Check	: Disabled		
Typematic Rate Setting	: Disabled		
Typematic Rate (Chars/Sec)	: 6		
Typematic Delay (Msec)	: 250		
Security Option	: Setup		
PCL/VGA Palette Snoop	: Disabled		
OS Select For DRAM>64MB	: Non-OS2		
Report No FDD For WIN 95	: Yes		
		ESC : Quit	↑ ↓ → ← : Select Item
		F1 : Help	PU/PD/+/- : Modify
		F5 : Old Values (Shift)	F2 : Color
		F6 : Load BIOS Defaults	
		F7 : Load Setup Defaults	

### 3.3.1 Virus Warning

When enabled, the BIOS will monitor the boot sector and the partition table on the hard drive for any attempt to modify. If an attempt is detected, the BIOS will halt the system and prompt the warning message. Select "Disabled" if you are installing a new operating system.

### 3.3.2 CPU Internal/External Cache

These options are to enable or disable CPU Internal (L1) Cache, or External (L2) Cache.

### 3.3.3 CPU L2 Cache ECC Checking

Select "Enabled" to enable CPU L2 Cache ECC Checking.  
 Select "Disabled" to disable CPU L2 Cache ECC Checking.

### 3.3.4 Quick Power On Self Test

Select "Enabled" to speed up time required to complete Power-On Self-Test.

### 3.3.5 Boot Sequence

This option allows user to assign boot sequence of the system. Available options are A, C, D, E, F, CD-ROM, SCSI and LS120/ZIP.

### 3.3.6 Swap Floppy Drive

When enabled, physical drive A will be assigned to logical drive B, and physical drive B will be assigned to logical drive A.

### 3.3.7 Boot Up Floppy Seek

The system will detect and verify operation of the floppy drive type .

### 3.3.8 Boot Up Numlock Status

The option allows the <NumLock> key to be activated after system boot up.

### 3.3.9 Gate A20 Option

This entry allows you to select how the gate A20 is handled. The gate A20 is a device used to address memory above 1 Mbytes. Initially, the gate A20 was handled via a pin on the keyboard (Normal). Today, while keyboards still provide this support, it is more common, and much faster, for the system chipset (Fast; default) to provide support for gate A20.

### 3.3.10 Memory Parity / ECC Check

When Disabled, there will be no memory errors shown on the monitor for Memory parity SERR# (NMI). When parity DRAM modules are used, select Parity or ECC (Error Checking and Correcting) to correct 1 bit memory errors in the memory.

### 3.3.11 Typematic Rate Setting

Select "Enabled" to configure "Typematic Rate" and "Typematic Delay" functions.

### 3.3.12 Typematic Rate

Use this option to set the rate at which a character keeps repeating while you hold down a key.

### 3.3.13 Typematic Delay

Select "Enabled" to set the length of delay before key strokes to repeat. Available options are "250", "500", "750", and "1000".

### 3.3.14 Security Option

You can select whether the password is required every time the system boots or only when you enter the Setup. You can assign "Supervisor Password" and "User Password" in the main CMOS Setup Utility Screen.

### 3.3.15 PCI/VGA Palette Snoop

Enable this option to correct screen color shifts, when there is a combination of VGA cards, accelerator cards, or MPEG cards present.

### 3.3.16 OS Select for DRAM > 64MB

If you are using OS/2 operating system and installed memory is larger than 64MB. You need to have the setting in the enable mode.

### 3.3.17 Report No FDD For WIN 95

While the FDD in "STANDARD CMOS SETUP" is set to NONE, set this option to No to release IRQ6 for passing Win95 logo. This option is irrelevant under normal operation.

### 3.3.18 Video BIOS Shadow

Video shadow copies BIOS code from slower ROM to faster RAM. BIOS can then execute from RAM.

### 3.3.19 C8000-CBFFF /DC000-DFFFF Shadow

Optional firmware will be copied from ROM to RAM. When this option is enabled.

## 3.4 Chipset Features Setup

These settings are intended for the Chipset function on the motherboard. Fine tuning these options, enhances the performance of the system.

Figure 3.4 CHIPSET FEATURES SETUP SCREEN

ROM PCI / ISA BIOS (XXXXXXXX)  
CHIPSET FEATURES SETUP  
AWARD SOFTWARE, INC.



Bank 0/1 DRAM Timing	: SDRAM 10ns	CPU Host Clock	: Default
Bank 2/3 DRAM Timing	: SDRAM 10ns		
Bank 4/5 DRAM Timing	: SDRAM 10ns		
SDRAM Cycle Length	: 3		
Memory Hole	: Disabled		
Read Around write	: Disabled		
Concurrent PCI/Host	: Disabled		
System BIOS Cacheable	: Enabled		
Video BIOS Cacheable	: Enabled	ESC : Quit	↑ ↓ → ← : Select Item
Video RAM Cacheable	: Enabled	F1 : Help	PU/PD/+/- : Modify
AGP Aperture Size	: 64M	F5 : Old Values	(Shift) F2 : Color
AGP-2X Mode	: Enabled	F6 : Load BIOS Defaults	
		F7 : Load Setup Defaults	

### 3.4.1 Bank 0/1, 2/3, 4/5 DRAM Timing

DRAM timing is controlled by the DRAM timing registers. The timings programmed into this register are dependent on the system design. The slower timing may be required in certain system designs to support loose layouts or slower memory. Options are SDRAM 10ns, SDRAM 8ns, Normal, Medium, Fast, Turbo.

### 3.4.2 SDRAM Cycle Length

This item allows you to set the SDRAM Latency Timer. Options are 2, 3.

### 3.4.3 Memory Hole

Enabling this feature reserves 15MB to 16MB memory address space to ISA expansion cards that specifically require this setting. This makes the memory from 15MB and up unavailable to the system. Expansion cards can only access memory up to 16MB.

### 3.4.4 Read Around write

DRAM optimization feature: If a memory read is addressed to a location whose latest write is being held in a buffer before being written to memory, the read is satisfied through the buffer contents, and the read is not sent to the DRAM.

### 3.4.5 Concurrent PCI/Host

When Disabled, CPU bus will be occupied during the entire PCI operation period.

### 3.4.6 System BIOS Cacheable

Allows the system BIOS to be cached for faster system performance.

### 3.4.7 Video BIOS Cacheable

Allows the video BIOS to be cached for faster video performance.

### 3.4.8 Video RAM Cacheable

Enabled allows caching of the video RAM, resulting in better system performance. However, if any program writes to this memory area, a system error may result.

### 3.4.9 AGP Aperture Size

Choose 4, 8, 16, 32, 64, 128MB. Memory-mapped, graphics data structures can reside in the Graphics Aperture.

### 3.4.10 AGP-2X Mode

Set to Enabled if your AGP card supports the 2X mode, which uses a double-clocked data technique to transfer twice the data per each AGP clock.

### 3.4.11 CPU Host Clock

Choose Default, 66, 75, 83, 100, 103, 105, 110, 112, 115, 120, 124 or 133Mhz for the external frequency of your CPU. You can select Default, 66, 75 or 83Mhz if your CPU is 66Mhz FSB and select Default, 100, 103, 105, 110, 112, 115, 120, 124 or 133Mhz if the CPU is 100Mhz FSB.

The 75, 83, 103, 105, 110, 112, 115, 120, 124 or 133Mhz frequency are optional.

The frequency mapping table of the elements:

Ext. frequency	AGP	PCI	ISA	DIMM
66Mhz	66Mhz	33Mhz	8.33Mhz	66Mhz
75Mhz	75Mhz	37.5Mhz	8.33Mhz	75Mhz
83Mhz	83Mhz	41.6Mhz	8.33Mhz	83Mhz
100Mhz	66Mhz	33Mhz	8.33Mhz	100Mhz
103Mhz	68.6Mhz	34.3Mhz	8.33Mhz	103Mhz
105 Mhz	70Mhz	35Mhz	8.33Mhz	105Mhz
110Mhz	73.3Mhz	36.67Mhz	8.33Mhz	110Mhz
112Mhz	74.6Mhz	37.3Mhz	8.33Mhz	112Mhz
115Mhz	76.6Mhz	38.33Mhz	8.33Mhz	115Mhz
120Mhz	80Mhz	40Mhz	8.33Mhz	120Mhz
124Mhz	82.6Mhz	41.33Mhz	8.33Mhz	124Mhz
133Mhz	88.6Mhz	44.33Mhz	8.33Mhz	133Mhz

**Notice:**

The 75, 83, 103, 105, 110, 112, 115, 120, 124 and 133Mhz frequency are over specification.

You must install 8ns or faster DIMM on board if you set 103, 105, 110, 112, 115, 120 or 124Mhz as external frequency and must install 7ns or faster DIMM on board if you set 133Mhz as external frequency.

**Warning:** Over specification operations are not recommended.

### 3.5 Power Management Setup

Power management decreases power usage under the pre-defined standby time range.

Figure 3-5. POWER MANAGEMENT SETUP SCREEN

ROM PCI / ISA BIOS (XXXXXXXX)  
POWER MANAGEMENT SETUP  
AWARD SOFTWARE, INC.

ACPI function : Disabled Power Management : Disabled PM Control by APM : Yes Video Off After : Suspend Video Off Method : V/H SYNC+Blank MODEM Use IRQ : 3 Soft-off by PWRBTTN : Instant-off HDD Power Down : Disabled Doze Mode : Disabled Suspend Mode : Disabled ** PM Events ** VGA : OFF LPT & COM : LPT / COM HDD & FDD : ON DMA/master : OFF Modem Ring Resume : Disabled RTC Alarm Resume : Disabled Wake Up On LAN : Disabled	Primary INTR : ON IRQ3 (COM2) : Primary IRQ4 (COM1) : Primary IRQ5 (LPT2) : Primary IRQ6 (Floppy Disk) : Primary IRQ7 (LPT1) : Primary IRQ8 (RTC Alarm) : Disabled IRQ9 (IRQ2 Redir) : Secondary IRQ10 (Reserved) : Secondary IRQ11 (Reserved) : Secondary IRQ12 (PS/2 Mouse) : Primary IRQ13 (Coprocessor) : Primary IRQ14 (Hard Disk) : Primary IRQ15 (Reserved) : Disabled  ESC : Quit      ↑ ↓ → ← : Select Item F1 : Help      PU/PD/+/- : Modify F5 : Old Values (Shift) F2 : Color F6 : Load BIOS Defaults F7 : Load Setup Defaults
---	---

### 3.5.1 ACPI Function

This item allows you to enable or disable the function of Advanced Configuration and Power Interface which offers improved power management .

### 3.5.2 Power Management

Mini Saving	System starts power saving function when the inactivity period exceeds 1 hour.
Max Saving	System starts power saving function when the inactivity period exceeds 1 min.
User Defined	Allows user to define the inactivity period before power saving function activates,

### 3.5.3 PM Control by APM

Select "Yes" if your system has Advanced Power Management (APM).

### 3.5.4 Video Off After

This option allows your monitor to blank after your system went into Doze or Suspend mode. You can elect to not blank screen by select " NA". Default value is " Suspend ".

### 3.5.5 Video Off Method

This field defines the video off features. The following options are available: DPMS Support, Blank Screen, V/H SYNC + Blank . The DPMS (Display Power Management System) features allow the BIOS to control the video display card if it supports the DPMS feature.

### 3.5.6 MODEM Use IRQ

This item tells the Power Management BIOS which IRQ is assigned to the installed MODEM. Option are NA, 3, 4, 5, 7, 9, 10 and 11.

### 3.5.7 Soft-Off by PWRBTN

When set to "Delay 4 Sec.", the ATX switch can be used as a normal system power-off button when pressed for less than 4 seconds. " Instant-off " disables the ATX switch function when the button is pressed under 4 seconds.

### 3.5.8 HDD Power Down

This instructs hard drives to shut off while in the Power Management modes.

### 3.5.9 Doze Mode

When system is inactive after the predefined time limit, system performance will drop down. This is the first level of Power Management.

### 3.5.10 Suspend Mode

System further shuts down all devices except for CPU itself. This is the third level of Power Management.

### 3.5.11 VGA

When set to On, any event occurring at a VGA port will awaken a system which has been powered down.

### 3.5.12 LPT & COM

When set to On, any event occurring at a LPT (printer) / COM (serial) port will awaken a system which has been powered down.

### 3.5.13 HDD & FDD

When set to On, any event occurring at a Hard Disk or floppy drive port will awaken a system which has been powered down.

### 3.5.14 DMA / master

When set to On, any event occurring to the DMA controller will awaken a system which has been powered down.

### 3.5.15 Modem Ring Resume

An incoming call on the external Modem power on the system. The function of power on through modem when system is off. When set to "Enabled" : To let the system to enter the environment of DOS or Windows 95/98 OS before system is power off. As long as there are any message through the Modem to enter the System during system is power off. The system will enable power on function.

### 3.5.16 RTC Alarm Resume

Set this option to enable or disable the RTC Alarm to Wake Up the system which is set at soft Off.

### 3.5.17 Date (of Month) Alarm, Timer (hh:mm:ss) Alarm

Set these options to specify the RTC Alarm time on Date / Hour / Minute / Second.

### 3.5.18 Wake Up On LAN

With a LAN card installed, the Wake-up on LAN function allows you to remotely power up your system through your network by sending a wake-up frame or signal. With this feature, you can remotely upload / download data to/from systems during off-peak hours

### 3.5.19 Primary INTR

When set to On (default), any primary interrupt request (see below) will awaken the system which has been powered down. Following this option is a list of IRQs (Interrupt ReQuests). You can set each IRQ to be Primary, Secondary or Disabled. When set to Secondary, the interrupt request will neither prevent the system from going into a power management mode nor awaken it.

## 3.6 PNP/PCI Configuration Setup

Figure 3.6 PNP/PCI CONFIGURATION SETUP

ROM PCI / ISA BIOS (XXXXXXXX)  
PNP/PCI CONFIGURATION  
AWARD SOFTWARE, INC.

PNP OS Installed	: No	Used MEM base addr	: N/A
Resources Controlled By	: Manual	Used MEM Length	: 8K
Reset Configuration Data	: Disabled	Assign IRQ For USB	: Enabled
IRQ-3 assigned to	: PCI/ISA PnP		
IRQ-4 assigned to	: PCI/ISA PnP		
IRQ-5 assigned to	: PCI/ISA PnP		
IRQ-7 assigned to	: PCI/ISA PnP		
IRQ-9 assigned to	: PCI/ISA PnP		
IRQ-10 assigned to	: PCI/ISA PnP		
IRQ-11 assigned to	: PCI/ISA PnP		
IRQ-12 assigned to	: PCI/ISA PnP		
IRQ-14 assigned to	: PCI/ISA PnP		
IRQ-15 assigned to	: PCI/ISA PnP		
DMA-0 assigned to	: PCI/ISA PnP		
DMA-1 assigned to	: PCI/ISA PnP		
DMA-3 assigned to	: PCI/ISA PnP		
DMA-5 assigned to	: PCI/ISA PnP		
DMA-6 assigned to	: PCI/ISA PnP		
DMA-7 assigned to	: PCI/ISA PnP		
		ESC : Quit	↑ ↓ → ← : Select Item
		F1 : Help	PU/PD/+/- : Modify
		F5 : Old Values	(Shift) F2 : Color
		F6 : Load BIOS Defaults	
		F7 : Load Setup Defaults	

### **3.6.1 PNP OS Installed**

This field allows you to use a Plug-and-Play (PnP) operating system.

Please set it as “ No “ if the operating system has no PnP function or to avoid reassigning the IRQs by the operating system.

### **3.6.2 Resources Controlled By**

Default setting is "Auto". This setting allows the BIOS to self detect setting and Plug-and-Play devices during start up. The user can select and configure IRQs under "Manual" mode.

### **3.6.3 Reset Configuration Data**

In case a conflict occurs after you assign the IRQs or after you configure your system, you can enable this function to allow your system to automatically reset your configuration and reassign the IRQs, DMAs, and I/O address.

### **3.6.4 IRQ-xx assigned to**

If your ISA card is not PnP compatible and requires a special IRQ to support its function, set the selected IRQ-x assigned to :“Legacy ISA”. This setting informs the PnP BIOS to reserve the selected IRQ for the installed legacy ISA card.

### **3.6.5 DMA-x assigned to**

If your ISA card is not PnP compatible and requires a special DMA channel to support its function, set the selected DMA channel to “Legacy ISA”. This setting informs the PnP BIOS to reserve the selected DMA channel for the installed legacy ISA card.

### **3.6.6 CPU to PCI Write Buffer**

When enabled, up to four D words of data can be written to the PCI bus without interrupting the CPU. When disabled, a write buffer is not used and the CPU read cycle will not be completed until the PCI bus signals that it is ready to receive the data.

### **3.6.7 PCI Dynamic Bursting**

When enabled, data transfer on the PCI bus, where possible, make use of the high-performance PCI bust protocol, in which greater amounts of data are transferred at a single command.

### **3.6.8 PCI Master 0 WS Write**

When enabled, writes to the PCI bus are command with zero wait states.

### **3.6.9 PCI Delay Transaction**

The chipset has an embedded 32-bit posted write buffer to support delay transactions cycles. Select Enabled to support compliance with PCI specification version 2.1.

### **3.6.10 PCI # 2 Access # 1 Retry**

This item allows you enabled/disabled the PCI # 2 Access # 1 Retry.

### **3.6.11 AGP Master 1 WS Write**

This implements a single delay when writing to the PCI Bus. By default, two-wait states are used by the system, allowing for greater stability.

### **3.6.12 AGP Master 1 WS Read**

This implements a single delay when reading to the PCI Bus. By default, two-wait states are used by the system, allowing for greater stability.

### 3.6.13 PCI IRQ Activated By

This sets the method by which the PCI bus recognizes that an IRQ service is being requested by a device. Under all circumstances, you should retain the default configuration unless advised otherwise by your system manufacturer. The choices are Level (default) and Edge.

### 3.6.14 Assign IRQ For USB

When Enabled, the system automatically assigns an IRQ for the USB device connected to your system. However, if you are not using USB devices and an ISA slot required an IRQ address, set this function to Disabled. The IRQ address previously occupied by the USB device will be available for the ISA slot.

### 3.6.15 Assign IRQ For VGA

The Enabled option allows the BIOS to auto-route an IRQ for use by a VGA card. While most of the VGA cards do not need the IRQ assignment, certain VGA cards may need it.

## 3.7 Integrated Peripherals

You can control Input and Output functions from this screen.

Figure 3-7 Integrated Peripherals

ROM PCI / ISA BIOS (XXXXXXXX)  
 INTEGRATED PERIPHERALS  
 AWARD SOFTWARE, INC.

OnChip IDE Channel 0	: Enabled	UR2 Mode	: Normal
OnChip IDE Channel 1	: Enabled	UR2 Duplex Mode	: Half
IDE Prefetch Mode	: Auto	Half Duplex time-out	: Enabled
IDE HDD Block Mode	: Enabled	Onboard Parallel Port	: 378/IRQ7
Primary Master PIO	: Auto	Parallel Port Mode	: ECP + EPP
Primary Slave PIO	: Auto	ECP Mode Use DMA	: 3
Secondary Master PIO	: Auto	OnChip USB	: Enabled
Secondary Slave PIO	: Auto	USB Keyboard Support	: Disabled
Primary Master UDMA	: Auto		
Primary Slave UDMA	: Auto		
Secondary Master UDMA	: Auto		
Secondary Slave UDMA	: Auto		
Init Display First	: AGP	ESC : Quit	↑ ↓ → ← : Select Item
Onboard FDC Controller	: Enabled	F1 : Help	PU/PD/+/- : Modify
Onboard Serial Port 1	: 3F8/IRQ4	F5 : Old Values	(Shift) F2 : Color
UR1 Mode	: Normal	F6 : Load BIOS Defaults	
UR1 Duplex Mode	: Half	F7 : Load Setup Defaults	
Half Duplex time-out	: Enabled		
Onboard Serial Port 2	: 2F8/IRQ3		

#### 3.7.1 OnChip IDE Channel 0/1

Select "Enabled" to activate each on-board IDE channel separately, Select "Disabled", if you install an add-on IDE Control card

#### 3.7.2 IDE Prefetch Mode

Enable prefetching for IDE drive interfaces that support its faster drive accesses. If you are getting disk drive errors, change the setting to omit the drive interface where the errors occur. Depending on the configuration of your IDE subsystem, this field may not appear, and it does appear when the Internal PCI/IDE filed, above, is Disabled.

#### 3.7.3 IDE HDD Block Mode

This feature enhances disk performance by allowing multi-sector data transfers and eliminates the interrupt handling time for each sector.

### 3.7.4 Primary & Secondary Master/Slave PIO

These four PIO fields let you set a PIO mode (0-4) for each of four IDE devices. When under "Auto" mode, the system automatically set the best mode for each device

### 3.7.5 Primary & Secondary Master/Slave UDMA

When set to "Auto" mode, the system will detect if the hard drive supports Ultra DMA mode.

### 3.7.6 Init Display First

Select "AGP" or "PCI Slot" for system to detect first when boot-up.

### 3.7.7 Onboard FDC Controller

Select "Enabled" to activate the on-board FDC  
Select "Disabled" to activate an add-on FDC

### 3.7.8 Onboard Serial Port 1 & 2

Select an address and corresponding interrupt for the first/second serial port. The default value for the first serial port is "3F8/IRQ4" and the second serial port is "2F8/IRQ3".

### 3.7.9 UR1/2 Mode

Select to activate the Infrared transfer function.

### 3.7.10 Onboard Parallel Port

Select address and interrupt for the Parallel port.

### 3.7.11 Parallel Port Mode

Select an operating mode for the parallel port. Mode options are SPP, EPP, ECP and ECP+EPP.

### 3.7.12 ECP Mode Use DMA

Select a DMA channel if parallel port is set as "ECP" or "ECP+EPP".

### 3.7.13 OnChip USB

If your system contains a Universal Serial Bus controller and you have a USB peripheral, select Enabled. The next option will become available.

### 3.7.14 USB Keyboard Support

This item lets you enable or disable the USB keyboard driver within the onboard BIOS.

## 3.8 Load BIOS Defaults

This loads the standard BIOS default values. To select, highlight it and press the <Enter> key. Then press the <Y> and <Enter> keys to confirm. Otherwise, press the <N> key to cancel.

## 3.9 Load Setup Defaults

This feature loads the setup default values from BIOS default table. To select, highlight it and press the <Enter> key. Then press the <Y> and <Enter> keys to confirm. Otherwise, press the <N> key to cancel.

## 3.10 Supervisor/User Password

You can assign, modify, or cancel password settings. To modify, highlight "Supervisor Password"

or "User Password" and press the <Enter> key. The screen will prompt you ("Enter Password:"). Enter your password. The maximum size of the password is 8 characters. System will prompt you to reenter the password to verify. Remember the passwords are case sensitive.

If you want to remove the passwords, either delete passwords or press <Enter> when prompting for new password.

If you want it to require password upon initial system startup and upon entering the CMOS Setup Utility, you will need to change the selection of the (Security Option) under (BIOS FEATURES SETUP) to "System".

If the setting is "Setup", the system will only require the password you activate CMOS Setup Utility.

### 3.11 IDE HDD Auto Detection

If your system has an IDE hard drive, you can use this function to detect its parameters and enter them into the "Standard CMOS Setup" automatically.

This routine only detects one set of parameters. If your hard disk is formatted using different parameters than those detected, you have to enter the parameters manually. If the parameters listed do not match the ones used to format the disk, the information on that disk will not be accessible. If the auto-detected parameters displayed do not match those that are used for your drive, ignore them. Type N to reject the values and enter the correct ones manually from the Standard CMOS Setup screen.

### 3.12 Exit CMOS Setup Utility

Press the <F10> key to save the setup and exit. Press <ESC> key to exit without saving. Either saving or not saving modifications, screen will prompt user to confirm, and system will reboot on exit.

## Chapter 4. Sound Driver Installation

**(The Sound function is optional. If you have sound on board, you can follow the below steps to load sound driver)**

### 4.1 Windows 95 Installation

#### 1. Start up Windows 95 OSR2.1 or later version

[ If your Windows 95 is older version, please install the USB supplement service pack ( usbsupp.exe ) files first. You can get this file from Microsoft Inc. ( <http://www.microsoft.com> ). ]

2. Remove the " ?PCI Multimedia Audio Devices " item from Start \Settings \Control Panel \System \Device Manager \?Other devices.
3. Insert the CD Driver into the CD drive - enter the \P2370A-V\SOUND\WIN9X directory on the CD-ROM and double-click SETUP.EXE
4. Choose the " Upgrade Drivers " option then click " Next " button.
5. Follow the prompts to complete the installation.
6. Restart your system.
7. The New Hardware Found Wizard will detect " PCI Multimedia Audio Device ". Click the " Next " button and select " Other Locations..." button. Type in [D:\P2370A-V\SOUND\WIN9X](#) and click " OK " button. (Assume the CD ROM is Ddrive)
8. Windows found the following updated driver for this device:ESS SOLO-1 PCI AudioDrive. Click " Finish " button.
9. When the Insert Disk dialog is displayed, please insert the " Windows 95 CD-ROM " into the CD drive, then click " OK " button. Type in " D:\WIN95 ", then click " OK " button.
10. Follow the prompts to complete the installation.

### 4.2 Windows 98 Installation



1. Start up Windows 98.
2. Open " My Computer ", and select " Control Panel " icon.
3. Select " System " icon, and then select " Device Manager " page.
4. Please remove " ?PCI Multimedia Audio Device " from " ?Other devices " under device list with the " Remove " button.
5. Please double click on the Add New Hardware icon then click " Next " button, click " Next " one more times.
6. This Wizard searches for new drivers for " PCI Multimedia Audio Device ", you have to attempt to locate a driver provided by the manufacturer.
7. Please insert the CD Driver into the CD drive, then click " Next " button.
8. " What do you want Windows to do? ", Please click " search for the best driver for your device [Recommended] ", then click " Next " button.
9. Please click " Specify a location ", then type in "D:\P2370A-\VISOUND\WIN9X ", then click " Next " button. Click " Next " one more times.

Note: D: is the Drive where CD Driver has been inserted.

10. . Click the " Finish " button.
11. . When Insert Disk dialog is displayed, please insert the " Windows 98 CD- ROM " into the CD drive, then click " OK " button.
12. . Windows found and installed Sound devices then click " Next " button.
13. . Click " Finish " button.

### 4.3 Windows NT 4.0 Installation

1. Login Windows NT 4.0
2. Insert the CD Driver into the CD drive - enter the \P2370A-\VISOUND\NT40 directory on the CD-ROM and double-click SETUP.EXE
3. Follow the prompts to complete the installation.
4. Restart your system.

### 4.4 AudioRack32 Installation

1. You must have Windows 95 , 98 or NT installed prior to using the AudioRack32. After placing the CD Driver in a CD drive, click START on the taskbar and choose RUN from the popup menu.
2. In the Run dialog box, type the letter of the drive and " setup " ( for example, D:\P2370A-\VISOUND\RACK32\SETUP ), then click OK.
3. The first AudioRack32 Setup dialog box appears. Note the instructions, then Click " Next " to proceed or " CANCEL " to leave Setup.
4. Next the Choose Destination Location dialog box appears. Click " Next " to install the AudioRack32 in the default directory or " Browse " to choose a different directory. When you are done click " OK " or " Cancel " to return to the Choose Destination Location dialog box.
5. If the directory you designate doesn't exist, you will be asked to confirm your selection. Click " YES " to proceed or " NO " to go back and enter a new destination directory.
6. Once you have chosen the default directory or entered a directory of your own choosing, the Setup Program will install the AudioRack32.