

==== NF61V Micro AM2 SE/NF61S Micro AM2 SE ====

Setup Manual

## **FCC Information and Copyright**

This equipment has been tested and found to comply with the limits of a Class B digital device, pursuant to Part 15 of the FCC Rules. These limits are designed to provide reasonable protection against harmful interference in a residential installation. This equipment generates, uses and can radiate radio frequency energy and, if not installed and used in accordance with the instructions, may cause harmful interference to radio communications. There is no guarantee that interference will not occur in a particular installation.

The vendor makes no representations or warranties with respect to the contents here and specially disclaims any implied warranties of merchantability or fitness for any purpose. Further the vendor reserves the right to revise this publication and to make changes to the contents here without obligation to notify any party beforehand.

Duplication of this publication, in part or in whole, is not allowed without first obtaining the vendor's approval in writing.

The content of this user's manual is subject to be changed without notice and we will not be responsible for any mistakes found in this user's manual. All the brand and product names are trademarks of their respective companies.

---

---

## Table of Contents

---

---

<b>Chapter 1: Introduction</b>	<b>1</b>
1.1 Before You Start	1
1.2 Package Checklist	1
1.3 Motherboard Features	2
1.4 Rear Panel Connectors (Ver 6.x)	4
1.5 Rear Panel Connectors (Ver 5.x)	4
1.6 Motherboard Layout (Ver 6.x)	5
1.7 Motherboard Layout (Ver 5.x)	6
<b>Chapter 2: Hardware Installation</b>	<b>7</b>
2.1 Installing Central Processing Unit (CPU)	7
2.2 FAN Headers	9
2.3 Installing System Memory	10
2.4 Connectors and Slots	12
<b>Chapter 3: Headers &amp; Jumpers Setup</b>	<b>14</b>
3.1 How to Setup Jumpers	14
3.2 Detail Settings	14
<b>Chapter 4: RAID Functions</b>	<b>22</b>
4.1 Operation System	22
4.2 Raid Arrays	22
4.3 How RAID Works	22
<b>Chapter 5: Useful Help</b>	<b>24</b>
5.1 Driver Installation Note	24
5.2 Award BIOS Beep Code	25
5.3 Extra Information	25
5.4 Troubleshooting	27
<b>Chapter 6: WarpSpeeder™</b>	<b>28</b>
6.1 Introduction	28
6.2 System Requirement	28
6.3 Installation	29
6.4 WarpSpeeder™	30
<b>Appendices: SPEC In Other Language</b>	<b>36</b>
German	36
France	38
Italian	40
Spanish	42
Portuguese	44
Polish	46
Russian	48
Arabic	50
Japanese	52

## **CHAPTER 1: INTRODUCTION**

### **1.1 BEFORE YOU START**

Thank you for choosing our product. Before you start installing the motherboard, please make sure you follow the instructions below:

- Prepare a dry and stable working environment with sufficient lighting.
- Always disconnect the computer from power outlet before operation.
- Before you take the motherboard out from anti-static bag, ground yourself properly by touching any safely grounded appliance, or use grounded wrist strap to remove the static charge.
- Avoid touching the components on motherboard or the rear side of the board unless necessary. Hold the board on the edge, do not try to bend or flex the board.
- Do not leave any unfastened small parts inside the case after installation. Loose parts will cause short circuits which may damage the equipment.
- Keep the computer from dangerous area, such as heat source, humid air and water.

### **1.2 PACKAGE CHECKLIST**

- ✦ FDD Cable X 1
- ✦ HDD Cable X 1
- ✦ User's Manual X 1
- ✦ Fully Setup Driver CD X 1
- ✦ Rear I/O Panel for ATX Case X 1
- ✦ Serial ATA Cable X 1 (optional)
- ✦ USB 2.0 Cable X1 (optional)
- ✦ S/PDIF Cable X 1 (optional)
- ✦ Serial ATA Power Switch Cable X 1 (optional)
- ✦ Printer Port Cable X 1 (optional)

### 1.3 MOTHERBOARD FEATURES

	NF61V Micro AM2 SE	NF61S Micro AM2 SE
CPU	Socket AM2 AMD Sempron / Athlon 64 / Athlon 64 FX / Athlon 64 X2 processors Supports Hyper Transport and Cool'nQuiet	Socket AM2 AMD Sempron / Athlon 64 / Athlon 64 FX / Athlon 64 X2 processors Supports Hyper Transport and Cool'nQuiet
FSB	Supports up to 1GHz Bandwidth	Supports up to 1GHz Bandwidth
Chipset	MCP61V ( GeForce 6100-400)	MCP61S ( GeForce 6100-405)
Super I/O	ITE 8716F Provides the most commonly used legacy Super I/O functionality. Low Pin Count Interface	ITE 8716F Provides the most commonly used legacy Super I/O functionality. Low Pin Count Interface
Main Memory	DIMM Slots x 2 Each DIMM supports 256/512MB & 1GB DDR2 Max Memory Capacity 2GB Dual Channel Mode DDR2 memory module Supports DDR2 400 / 533 / 667 / 800	DIMM Slots x 2 Each DIMM supports 256/512MB & 1GB DDR2 Max Memory Capacity 2GB Dual Channel Mode DDR2 memory module Supports DDR2 400 / 533 / 667 / 800
Graphics	Integrated in MCP61V Chipset Max Shared Video Memory is 256MB	Integrated in MCP61S Chipset Max Shared Video Memory is 256MB
IDE	Integrated IDE Controller Ultra DMA 33 / 66 / 100 / 133 Bus Master Mode supports PIO Mode 0~4	Integrated IDE Controller Ultra DMA 33 / 66 / 100 / 133 Bus Master Mode supports PIO Mode 0~4
SATA II	Integrated Serial ATA Controller Data transfer rates up to 3.0 Gb/s. SATA Version 2.0 specification compliant.	Integrated Serial ATA Controller Data transfer rates up to 3.0 Gb/s. SATA Version 2.0 specification compliant.
LAN	Realtek 8201CL PHY 10 / 100 Mb/s Auto-Negotiation	Realtek 8201CL PHY 10 / 100 Mb/s Auto-Negotiation
Sound	ALC861VD(Ver 6.x) / ALC888(Ver 5.x) 5.1 channels audio out (Ver 6.x) 7.1 channels audio out (Ver 5.x) Intel High-Definition Audio support	ALC861VD(Ver 6.x) / ALC888(Ver 5.x) 5.1 channels audio out (Ver 6.x) 7.1 channels audio out (Ver 5.x) Intel High-Definition Audio support
Slots	PCI slot x2 PCI Express x16 slot (x1 Speed) x1 PCI Express x 1 slot x1	PCI slot x2 PCI Express x 16 slot (x8 Speed) x1 PCI Express x 1 slot x1

**NF61V Micro AM2 SE/NF61S Micro AM2 SE**

		<b>NF61V Micro AM2 SE</b>			<b>NF61S Micro AM2 SE</b>
On Board Connector	Floppy connector	x1	Floppy connector	x1	
	IDE Connector	x1	IDE Connector	x1	
	SATA2 Connector	x2	SATA2 Connector	x2	
	Front Panel Connector	x1	Front Panel Connector	x1	
	Front Audio Connector	x1	Front Audio Connector	x1	
	CD-in Connector	x1	CD-in Connector	x1	
	S/PDIF out connector	x1	S/PDIF out connector	x1	
	S/PDIF in connector(Optional)	x1	S/PDIF in connector(Optional)	x1	
	CPU Fan header	x1	CPU Fan header	x1	
	System Fan header	x1	System Fan header	x1	
	CMOS clear header	x1	CMOS clear header	x1	
	USB connector	x2	USB connector	x2	
	Printer Port Connector	x1	Printer Port Connector	x1	
	Chassis open header(Optional)	x1	Chassis open header(Optional)	x1	
	Power Connector (24pin)	x1	Power Connector (24pin)	x1	
	Power Connector (4pin)	x1	Power Connector (4pin)	x1	
Back Panel I/O	PS/2 Keyboard	x1	PS/2 Keyboard	x1	
	PS/2 Mouse	x1	PS/2 Mouse	x1	
	Serial Port	x1	Serial Port	x1	
	VGA port	x1	VGA port	x1	
	LAN port	x1	LAN port	x1	
	USB Port	x4	USB Port	x4	
	Audio Jack (Ver 6.x)	x3	Audio Jack (Ver 6.x)	x3	
Audio Jack (Ver 5.x)	x6	Audio Jack (Ver 5.x)	x6		
Board Size	207 x 244 (mm) Micro ATX Size Board				207 x 244 (mm) Micro ATX Size Board
Special Features	NVIDIA nTune RAID 0 / 1 support				NVIDIA nTune RAID 0 / 1 support
OS Support	Windows 2000 / XP / VISTA Biostar Reserves the right to add or remove support for any OS With or without notice.				Windows 2000 / XP / VISTA Biostar Reserves the right to add or remove support for any OS With or without notice.

### 1.4 REAR PANEL CONNECTORS (VER 6.x)

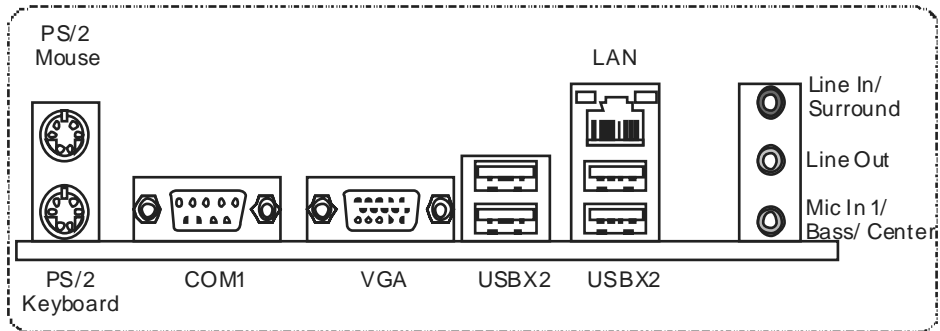

### 1.5 REAR PANEL CONNECTORS (VER 5.x)

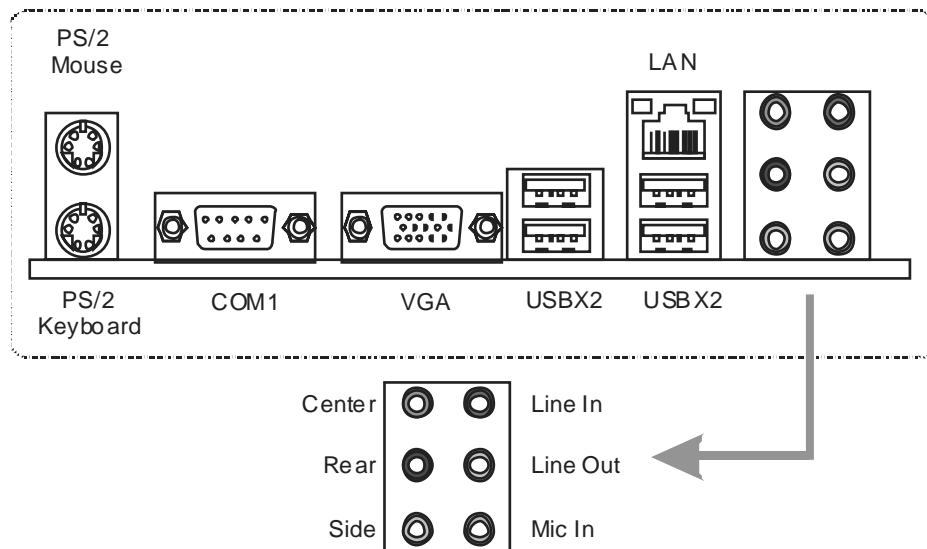



## 1.7 MOTHERBOARD LAYOUT (VER 5.x)

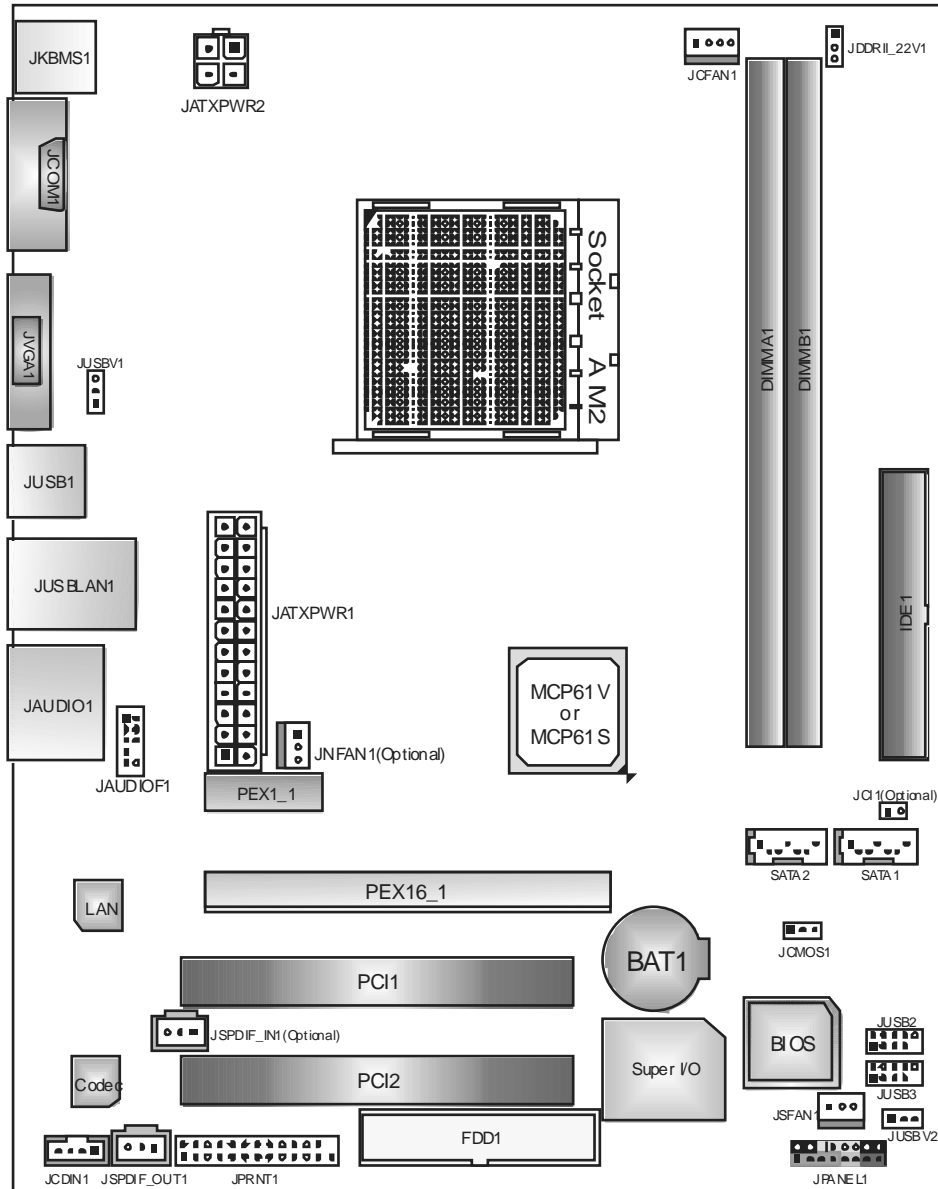

**Note:** ■ represents the 1<sup>st</sup> pin.



## **CHAPTER 2: HARDWARE INSTALLATION**

### **2.1 INSTALLING CENTRAL PROCESSING UNIT (CPU)**

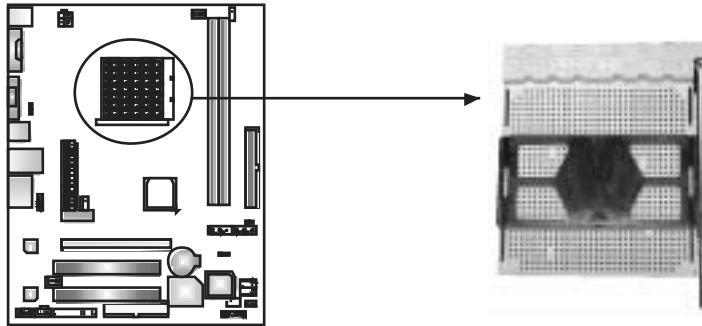

**Step 1:** Remove the socket protection cap.

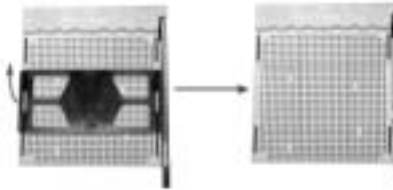

**Step 2:** Pull the lever toward direction A from the socket and then raise the lever up to a 90-degree angle.

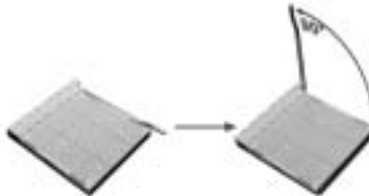

**Step 3:** Look for the white triangle on socket, and the gold triangle on CPU should point towards this white triangle. The CPU will fit only in the correct orientation.



**Step 4:** Hold the CPU down firmly, and then close the lever toward direct B to complete the installation.

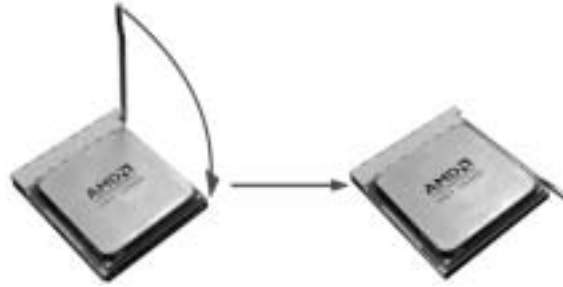

**Step 5:** Put the CPU Fan on the CPU and buckle it. Connect the CPU FAN power cable to the JCFAN1. This completes the installation.

## 2.2 FAN HEADERS

These fan headers support cooling-fans built in the computer. The fan cable and connector may be different according to the fan manufacturer. Connect the fan cable to the connector while matching the black wire to pin#1.

### JCFAN1: CPU Fan Header

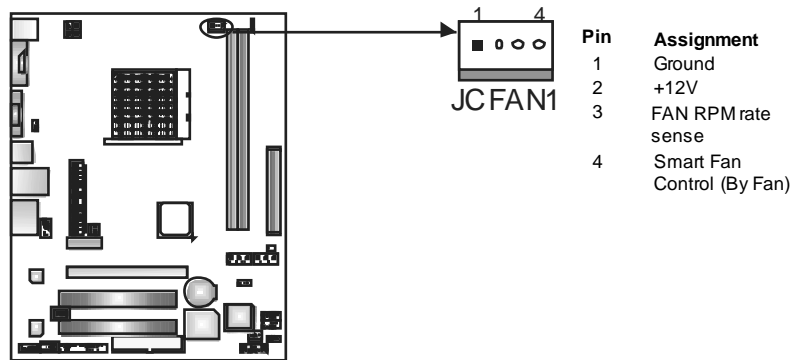

### JSFAN1: System Fan Header

### JNFAN1: North Bridge Fan Header (Optional)

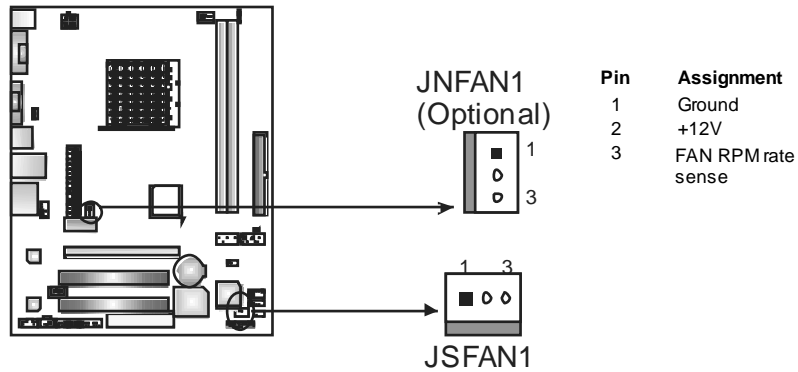

**Note:**

The JCFAN1, JSFAN1 and JNFAN1 support 4-pin and 3-pin head connector. When connecting with wires onto connectors, please note that the red wire is the positive and should be connected to pin#2, and the black wire is Ground and should be connected to GND.

## 2.3 INSTALLING SYSTEM MEMORY

### A. Memory Modules

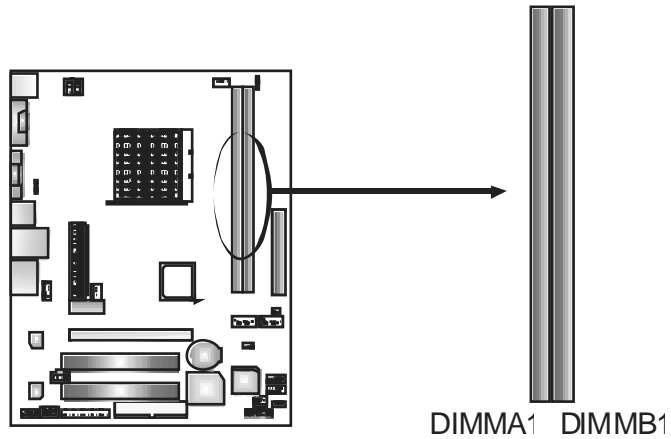

1. Unlock a DIMM slot by pressing the retaining clips outward. Align a DIMM on the slot such that the notch on the DIMM matches the break on the Slot.

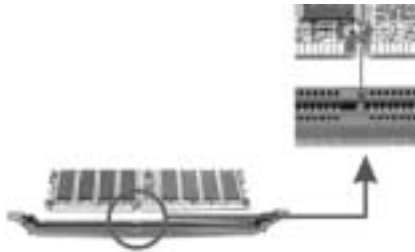

2. Insert the DIMM vertically and firmly into the slot until the retaining chip snap back in place and the DIMM is properly seated.

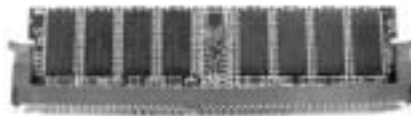

### *B. Memory Capacity*

<b>DIMM Socket Location</b>	<b>DDR Module</b>	<b>Total Memory Size</b>
DIMMA1	256MB/512MB/1024MB *1	Max memory 2GB.
DIMMB1	256MB/512MB/1024MB *1	

### *C. Dual Channel Memory installation*

To trigger the Dual Channel function of the motherboard, the memory module must meet the following requirements:

Install memory module of the same density in pair, shown in the following table.

<b>Dual Channel Status</b>	<b>DIMMA1</b>	<b>DIMMB1</b>
Disabled	O	X
Disabled	X	O
Enabled	O	O

(O means memory installed, X means memory not installed.)

The DRAM bus width of the memory module must be the same (x8 or x16)

## 2.4 CONNECTORS AND SLOTS

### FDD1: Floppy Disk Connector

The motherboard provides a standard floppy disk connector that supports 360K, 720K, 1.2M, 1.44M and 2.88M floppy disk types. This connector supports the provided floppy drive ribbon cables.

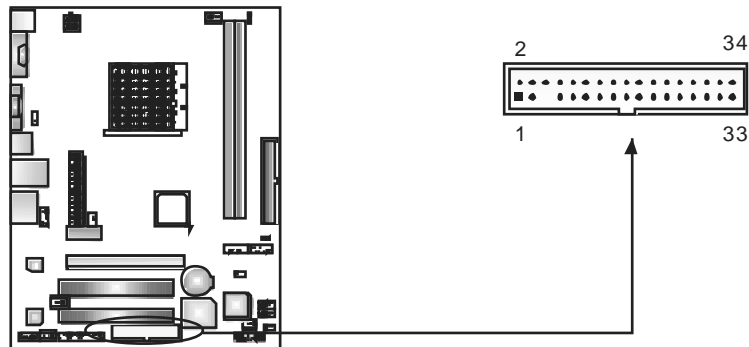

### IDE1: Hard Disk Connector

The motherboard has a 32-bit Enhanced IDE Controller that provides PIO Mode 0~4, Bus Master, and Ultra DMA 33/66/100/133 functionality.

The IDE connector can connect a master and a slave drive, so you can connect up to two hard disk drives.

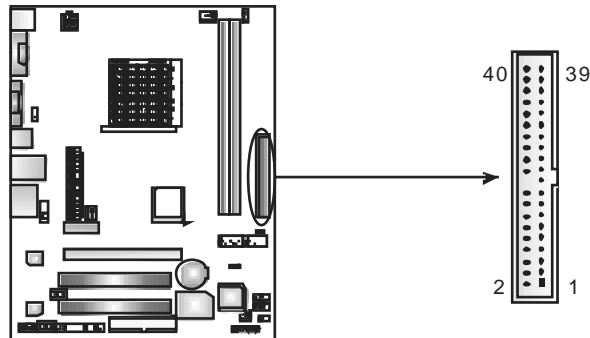

**PEX1\_1: PCI-Express x1 Slot**

- PCI-Express 1.0a compliant.
- Data transfer bandwidth up to 250MB/s per direction; 500MB/s in total.
- PCI-Express supports a raw bit-rate of 2.5Gb/s on the data pins.
- 2X bandwidth over the traditional PCI architecture.

**PEX16\_1: PCI-Express x16 Slot (x1 Speed)**  
**(for NF61V Micro AM2 SE)**

- PCI-Express 1.0a compliant.
- Maximum theoretical realized bandwidth of 250MB/s simultaneously per direction, for an aggregate of 500MB/s totally.

**PEX16\_1: PCI-Express x16 Slot (x8 Speed)**  
**(for NF61S Micro AM2 SE)**

- PCI-Express 1.0a compliant.
- Maximum theoretical realized bandwidth of 2GB/s simultaneously per direction, for an aggregate of 4GB/s totally.

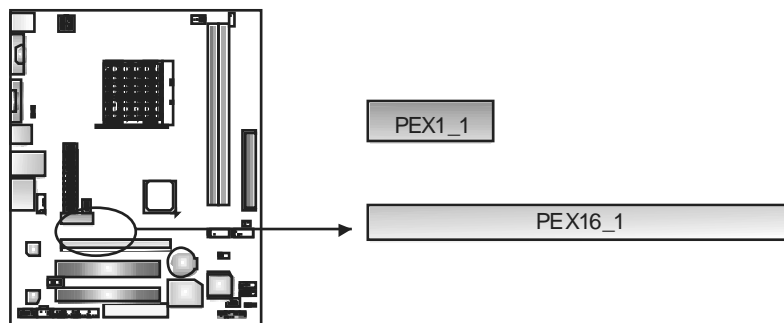

**PCI1~PCI2: Peripheral Component Interconnect Slots**

This motherboard is equipped with 2 standard PCI slots. PCI stands for Peripheral Component Interconnect, and it is a bus standard for expansion cards. This PCI slot is designated as 32 bits.

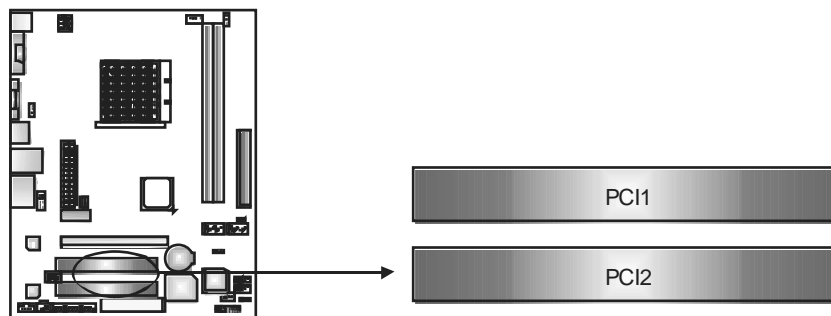

## CHAPTER 3: HEADERS & JUMPERS SETUP

### 3.1 HOW TO SETUP JUMPERS

The illustration shows how to set up jumpers. When the jumper cap is placed on pins, the jumper is “close”, if not, that means the jumper is “open”.



### 3.2 DETAIL SETTINGS

#### JPANEL1: Front Panel Header

This 16-pin connector includes Power-on, Reset, HDD LED, Power LED, Sleep button and speaker connection. It allows user to connect the PC case’s front panel switch functions.

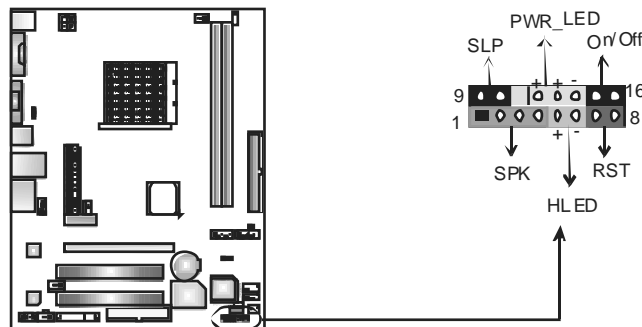

Pin	Assignment	Function	Pin	Assignment	Function
1	+5V	Speaker Connector	9	Sleep control	Sleep button
2	N/A		10	Ground	
3	N/A		11	N/A	N/A
4	Speaker	Hard drive LED	12	Power LED (+)	Power LED
5	HDD LED (+)		13	Power LED (+)	
6	HDD LED (-)		14	Power LED (-)	
7	Ground	Reset button	15	Power button	Power-on button
8	Reset control		16	Ground	



**JATXPWR1: ATX Power Source Connector**

This connector allows user to connect 24-pin power connector on the ATX power supply.

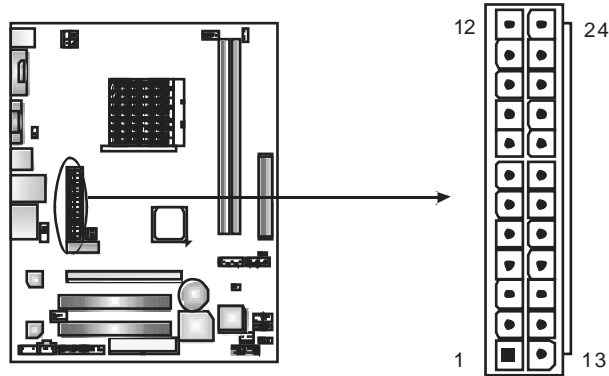

Pin	Assignment	Pin	Assignment
13	+3.3V	1	+3.3V
14	-12V	2	+3.3V
15	Ground	3	Ground
16	PS_ON	4	+5V
17	Ground	5	Ground
18	Ground	6	+5V
19	Ground	7	Ground
20	NC	8	PW_OK
21	+5V	9	Standby Voltage+5V
22	+5V	10	+12V
23	+5V	11	+12V
24	Ground	12	+3.3V

**JATXPWR2: ATX Power Source Connector**

By connecting this connector, it will provide +12V to CPU power circuit.

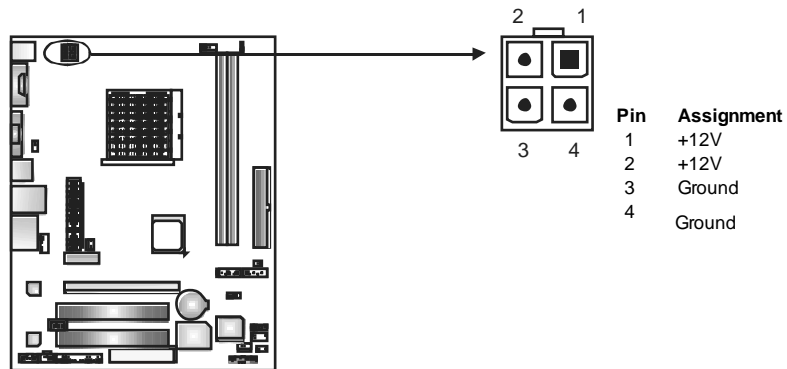

### JUSB2/JUSB3: Headers for USB 2.0 Ports at Front Panel

This header allows user to connect additional USB cable on the PC front panel, and also can be connected with internal USB devices, like USB card reader.

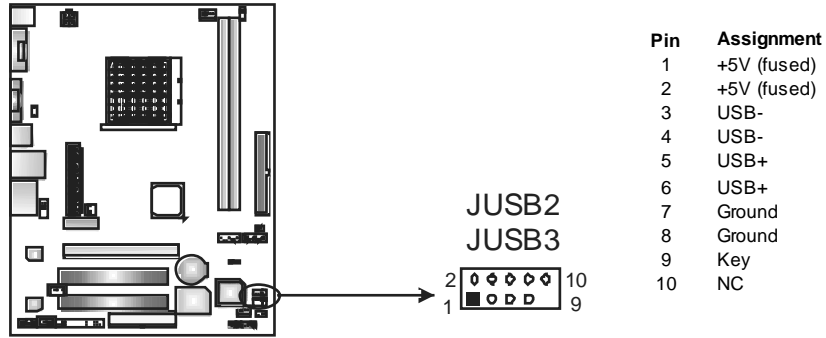

### JUSBV1/JUSBV2: Power Source Headers for USB Ports

**Pin 1-2 Close:**

JUSBV1: +5V for USB ports at JUSBLAN1.

JUSBV2: +5V for USB ports at front panel (JUSB2/JUSB3).

**Pin 2-3 Close:**

JUSBV1: USB ports at JUSBLAN1 are powered by +5V standby voltage.

JUSBV2: USB ports at front panel (JUSB2/JUSB3) are powered by +5V standby voltage.

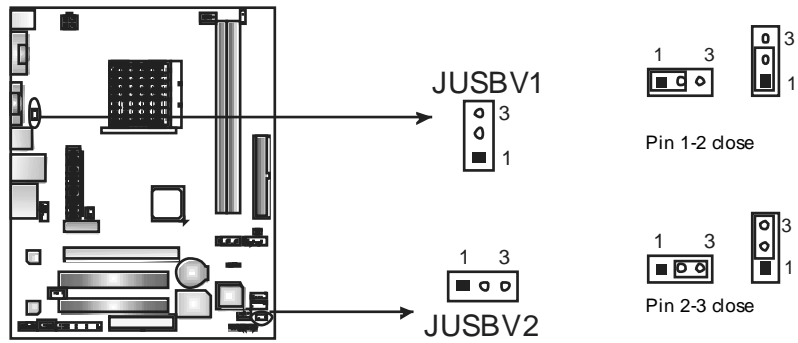

**Note:**

In order to support this function "Power-On system via USB device," "JUSBV1/ JUSBV2" jumper cap should be placed on Pin 2-3 individually

### JAUDIOF1: Front Panel Audio Header

This header allows user to connect the front audio output cable with the PC front panel. It will disable the output on back panel audio connectors.

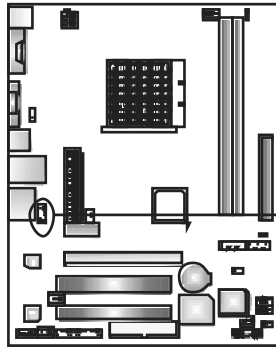

Pin	Assignment
1	Mic in
2	Ground
3	Mic power
4	Audio power
5	Right line out
6	Ground
7	Reserved
8	Key
9	Left line out
10	Ground

### JCDIN1: CD-ROM Audio-in Connector

This connector allows user to connect the audio source from the variety devices, like CD-ROM, DVD-ROM, PCI sound card, PCI TV turner card etc.

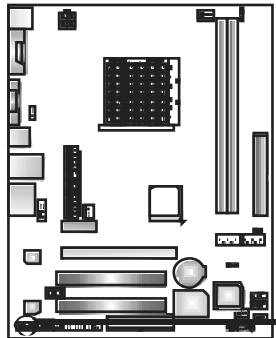

Pin	Assignment
1	Left Channel Input
2	Ground
3	Ground
4	Right Channel Input

### JCMOS1: Clear CMOS Header

By placing the jumper on pin2-3, it allows user to restore the BIOS safe setting and the CMOS data, please carefully follow the procedures to avoid damaging the motherboard.

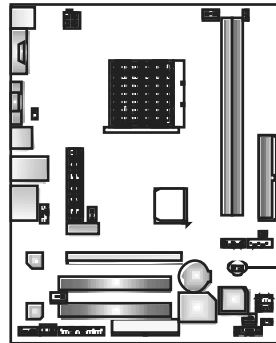

**Pin 1-2 Close:**  
Normal Operation  
(default).



**Pin 2-3 Close:**  
Clear CMOS  
data.

#### ※ Clear CMOS Procedures:

1. Remove AC power line.
2. Set the jumper to "Pin 2-3 close".
3. Wait for five seconds.
4. Set the jumper to "Pin 1-2 close".
5. Power on the AC.
6. Reset your desired password or clear the CMOS data.

### JCI1: Chassis Open Header (Optional)

This connector allows system to monitor PC case open status. If the signal has been triggered, it will record to the CMOS and show the message on next boot-up.

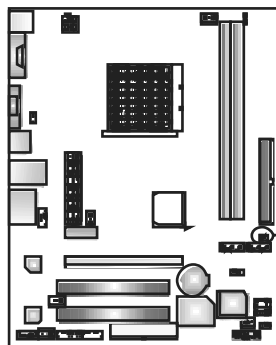

Pin	Assignment
1	Case open signal
2	Ground

**JPRNT1: Printer Port Connector**

This header allows you to connector printer on the PC.

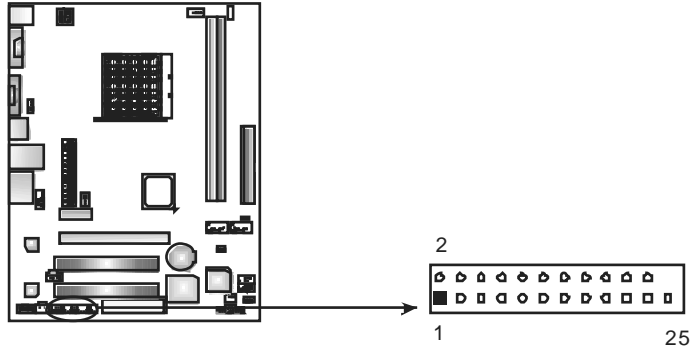

Pin	Assignment	Pin	Assignment
1	-Strobe	14	Ground
2	-ALF	15	Data 6
3	Data 0	16	Ground
4	-Error	17	Data 7
5	Data 1	18	Ground
6	-Init	19	-ACK
7	Data 2	20	Ground
8	-Scitn	21	Busy
9	Data 3	22	Ground
10	Ground	23	PE
11	Data 4	24	Ground
12	Ground	25	SCLT
13	Data 5	26	Key

**SATA1~SATA2: Serial ATA Connectors**

The motherboard has a PCI to SATA Controller with 2 channels SATA interface, it satisfies the SATA 2.0 spec and with transfer rate of 3.0Gb/s.

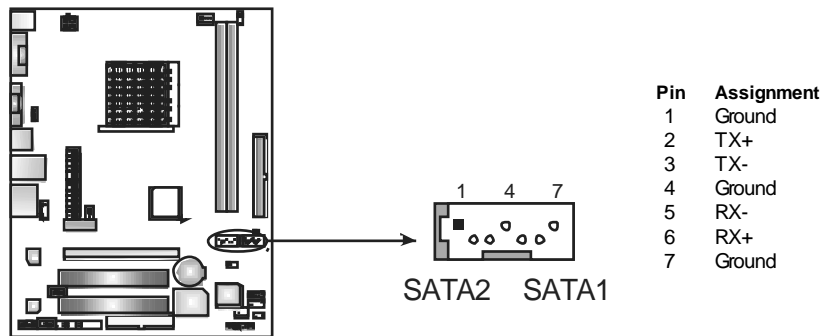

### Header for Memory over-voltage: JDDRII\_22V1

When processing Memory over-voltage, please place the jumper to pin2-3 Closed. The Default setting is Pin 1-2 Closed.

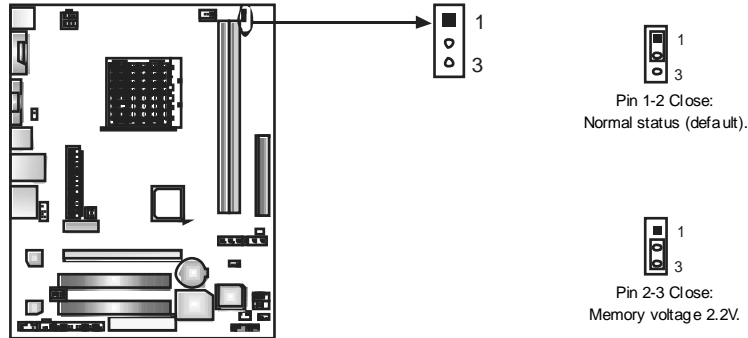

**Note:**

1. When “JDDRII\_22V1” jumper cap is placed on Pin 1-2, memory voltage can be manually adjusted in CMOS setup screen.
2. When “JDDRII\_22V1” jumper cap is placed on Pin 2-3, memory voltage will be fixed at 2.2V automatically, and can't be adjusted under COMS setup.

Before setting memory over-voltage, please ensure that your DDR2 supports up to 2.2V. (Consult your DDR2 supplier)

### JSPDIF\_OUT1: Digital Audio-out Connector

This connector allows user to connect the PCI bracket SPDIF output header.

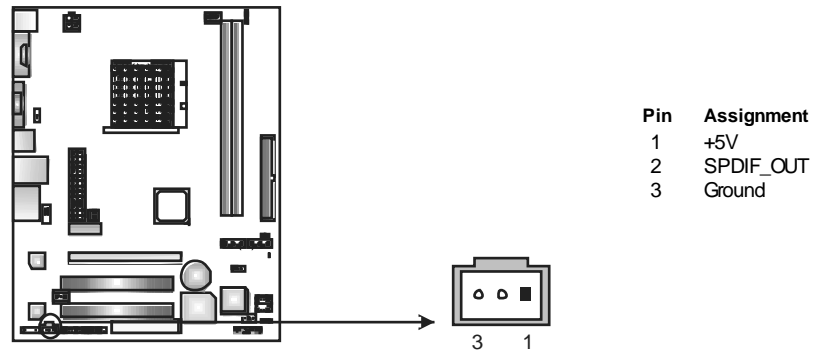

**JSPDIF\_IN1: Digital Audio-in Connector (optional)**

This connector allows user to connect the PCI bracket SPDIF input header.

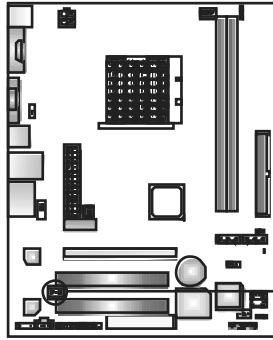

Pin	Assignment
1	+5V
2	SPDIF_IN
3	Ground

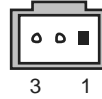

---

---

## CHAPTER 4: RAID FUNCTIONS

### 4.1 OPERATION SYSTEM

Supports Windows XP Home/Professional Edition, and Windows 2000 Professional.

### 4.2 RAID ARRAYS

RAID supports the following types of RAID arrays:

**RAID 0:** RAID 0 defines a disk striping scheme that improves disk read and write times for many applications.

**RAID 1:** RAID 1 defines techniques for mirroring data.

### 4.3 How RAID WORKS

#### **RAID 0:**

The controller “stripes” data across multiple drives in a RAID 0 array system. It breaks up a large file into smaller blocks and performs disk reads and writes across multiple drives in parallel. The size of each block is determined by the stripe size parameter, which you set during the creation of the RAID set based on the system environment. This technique reduces overall disk access time and offers high bandwidth.

#### **Features and Benefits**

- **Drives:** Minimum 1, and maximum is up to 6 or 8. Depending on the platform.
- **Uses:** Intended for non-critical data requiring high data throughput, or any environment that does not require fault tolerance.
- **Benefits:** provides increased data throughput, especially for large files. No capacity loss penalty for parity.
- **Drawbacks:** Does not deliver any fault tolerance. If any drive in the array fails, all data is lost.
- **Fault Tolerance:** No.

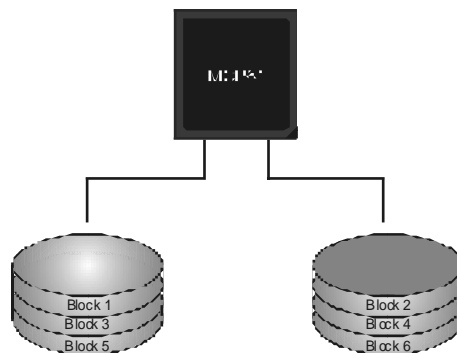



**RAID 1:**

Every read and write is actually carried out in parallel across 2 disk drives in a RAID 1 array system. The mirrored (backup) copy of the data can reside on the same disk or on a second redundant drive in the array. RAID 1 provides a hot-standby copy of data if the active volume or drive is corrupted or becomes unavailable because of a hardware failure.

RAID techniques can be applied for high-availability solutions, or as a form of automatic backup that eliminates tedious manual backups to more expensive and less reliable media.

**Features and Benefits**

- **Drives:** Minimum 2, and maximum is 2.
- **Uses:** RAID 1 is ideal for small databases or any other application that requires fault tolerance and minimal capacity.
- **Benefits:** Provides 100% data redundancy. Should one drive fail, the controller switches to the other drive.
- **Drawbacks:** Requires 2 drives for the storage space of one drive. Performance is impaired during drive rebuilds.
- **Fault Tolerance:** Yes.

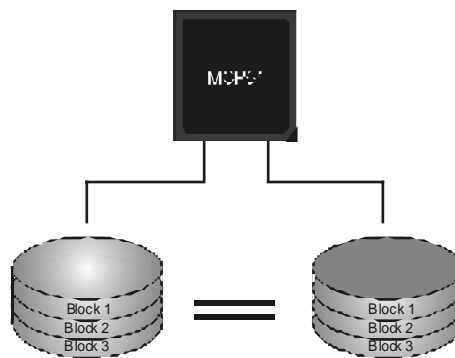

※ For more detailed setup information, please refer to the Driver CD, or go to [http://www.nvidia.com/page/pg\\_20011106217193.html](http://www.nvidia.com/page/pg_20011106217193.html) to download NVIDIA nForce Tutorial Flash.

## CHAPTER 5: USEFUL HELP

### 5.1 DRIVER INSTALLATION NOTE

After you installed your operating system, please insert the Fully Setup Driver CD into your optical drive and install the driver for better system performance.

You will see the following window after you insert the CD

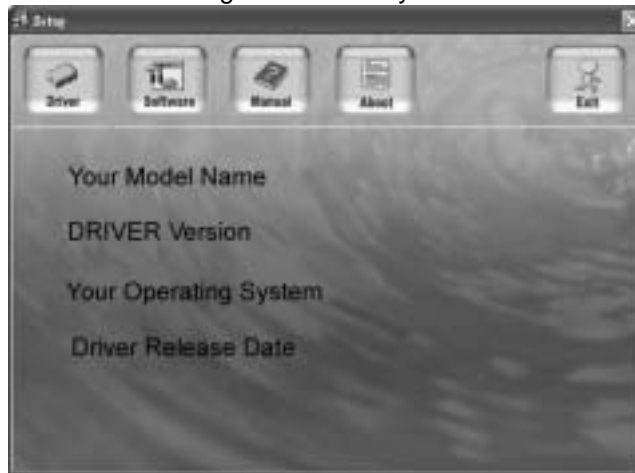

The setup guide will auto detect your motherboard and operating system.

**Note:**

If this window didn't show up after you insert the Driver CD, please use file browser to locate and execute the file **SETUP.EXE** under your optical drive.

#### A. Driver Installation

To install the driver, please click on the Driver icon. The setup guide will list the compatible driver for your motherboard and operating system. Click on each device driver to launch the installation program.

#### B. Software Installation

To install the software, please click on the Software icon. The setup guide will list the software available for your system, click on each software title to launch the installation program.

#### C. Manual

Aside from the paperback manual, we also provide manual in the Driver CD. Click on the Manual icon to browse for available manual.

**Note:**

You will need Acrobat Reader to open the manual file. Please download the latest version of Acrobat Reader software from <http://www.adobe.com/products/acrobat/readstep2.html>

## 5.2 AWARD BIOS BEEP CODE

Beep Sound	Meaning
One long beep followed by two short beeps	Video card not found or video card memory bad
High-low siren sound	CPU overheated System will shut down automatically
One Short beep when system boot-up	No error found during POST
Long beeps every other second	No DRAM detected or install

## 5.3 EXTRA INFORMATION

### A. BIOS Update

After you fail to update BIOS or BIOS is invaded by virus, the Boot-Block function will help to restore BIOS. If the following message is shown after boot-up the system, it means the BIOS contents are corrupted.

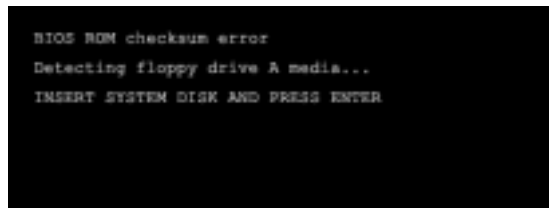

In this Case, please follow the procedure below to restore the BIOS:

1. Make a bootable floppy disk.
2. Download the Flash Utility "AWDFLASH.exe" from the Biostar website: [www.biostar.com.tw](http://www.biostar.com.tw)
3. Confirm motherboard model and download the respectively BIOS from Biostar website.
4. Copy "AWDFLASH.exe" and respectively BIOS into floppy disk.
5. Insert the bootable disk into floppy drive and press Enter.
6. System will boot-up to DOS prompt.
7. Type "Awdflash xxxx.bf/sn/py/r" in DOS prompt.  
(xxxx means BIOS name.)
8. System will update BIOS automatically and restart.
9. The BIOS has been recovered and will work properly.

### **B. CPU Overheated**

If the system shutdown automatically after power on system for seconds, that means the CPU protection function has been activated.

When the CPU is over heated, the motherboard will shutdown automatically to avoid a damage of the CPU, and the system may not power on again.

In this case, please double check:

1. The CPU cooler surface is placed evenly with the CPU surface.
2. CPU fan is rotated normally.
3. CPU fan speed is fulfilling with the CPU speed.

After confirmed, please follow steps below to relief the CPU protection function.

1. Remove the power cord from power supply for seconds.
2. Wait for seconds.
3. Plug in the power cord and boot up the system.

Or you can:

1. Clear the CMOS data.  
(See "Close CMOS Header: JCMOS1" section)
2. Wait for seconds.
3. Power on the system again.

## 5.4 TROUBLESHOOTING

Probable	Solution
<ol style="list-style-type: none"> <li>No power to the system at all. Power light don't illuminate, fan inside power supply does not turn on.</li> <li>Indicator light on key board does not turn on.</li> </ol>	<ol style="list-style-type: none"> <li>Make sure power cable is securely plugged in.</li> <li>Replace cable.</li> <li>Contact technical support.</li> </ol>
System inoperative. Keyboard lights are on, power indicator lights are lit, and hard drive is spinning.	Using even pressure on both ends of the DIMM, press down firmly until the module snaps into place.
System does not boot from hard disk drive, can be booted from optical drive.	<ol style="list-style-type: none"> <li>Check cable running from disk to disk controller board. Make sure both ends are securely plugged in; check the drive type in the standard CMOS setup.</li> <li>Backing up the hard drive is extremely important. All hard disks are capable of breaking down at any time.</li> </ol>
System only boots from optical drive. Hard disk can be read and applications can be used but booting from hard disk is impossible.	<ol style="list-style-type: none"> <li>Back up data and applications files.</li> <li>Reformat the hard drive. Re-install applications and data using backup disks.</li> </ol>
Screen message says "Invalid Configuration" or "CMOS Failure."	Review system's equipment. Make sure correct information is in setup.
Cannot boot system after installing second hard drive.	<ol style="list-style-type: none"> <li>Set master/slave jumpers correctly.</li> <li>Run SETUP program and select correct drive types. Call the drive manufacturers for compatibility with other drives.</li> </ol>

## **CHAPTER 6: WARPSPEEDER™**



### **6.1 INTRODUCTION**

[WarpSpeeder™], a new powerful control utility, features three user-friendly functions including Overclock Manager, Overvoltage Manager, and Hardware Monitor.

With the Overclock Manager, users can easily adjust the frequency they prefer or they can get the best CPU performance with just one click. The Overvoltage Manager, on the other hand, helps to power up CPU core voltage and Memory voltage. The cool Hardware Monitor smartly indicates the temperatures, voltage and CPU fan speed as well as the chipset information. Also, in the About panel, you can get detail descriptions about BIOS model and chipsets. In addition, the frequency status of CPU, memory, AGP and PCI along with the CPU speed are synchronically shown on our main panel.

Moreover, to protect users' computer systems if the setting is not appropriate when testing and results in system fail or hang, [WarpSpeeder™] technology assures the system stability by automatically rebooting the computer and then restart to a speed that is either the original system speed or a suitable one.

### **6.2 SYSTEM REQUIREMENT**

OS Support: Windows 98 SE, Windows Me, Windows 2000, Windows XP  
DirectX: DirectX 8.1 or above. (The Windows XP operating system includes DirectX 8.1. If you use Windows XP, you do not need to install DirectX 8.1.)

### 6.3 INSTALLATION

1. Execute the setup execution file, and then the following dialog will pop up. Please click "Next" button and follow the default procedure to install.

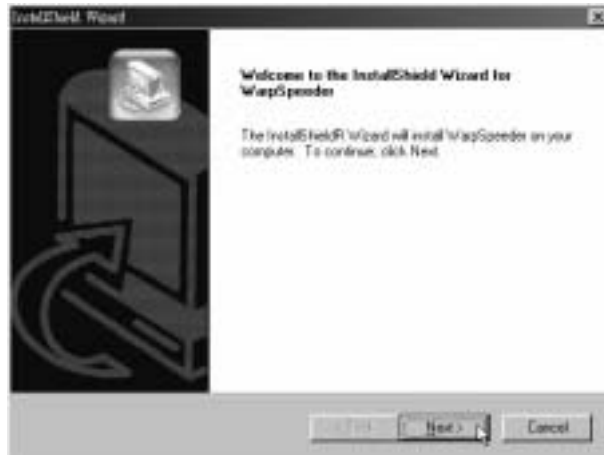

2. When you see the following dialog in setup procedure, it means setup is completed. If the "Launch the WarpSpeeder Tray Utility" checkbox is checked, the Tray Icon utility and [WarpSpeeder™] utility will be automatically and immediately launched after you click "Finish" button.



#### Usage:

The following figures are just only for reference, the screen printed in this user manual will change according to your motherboard on hand.

## 6.4 WARPSPEDER™

### 1. **Tray Icon:**

Whenever the Tray Icon utility is launched, it will display a little tray icon on the right side of Windows Taskbar.

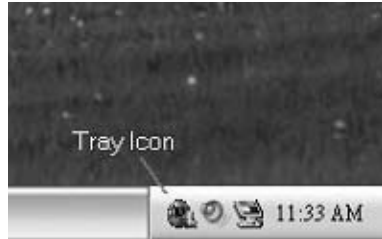

This utility is responsible for conveniently invoking [WarpSpeeder™] Utility. You can use the mouse by clicking the left button in order to invoke [WarpSpeeder™] directly from the little tray icon or you can right-click the little tray icon to pop up a popup menu as following figure. The “Launch Utility” item in the popup menu has the same function as mouse left-click on tray icon and “Exit” item will close Tray Icon utility if selected.





## 2. Main Panel

If you click the tray icon, [WarpSpeeder™] utility will be invoked.  
Please refer to the following figure; the utility's first window you will see is Main Panel.

### Main Panel contains features as follows:

- Display the CPU Speed, CPU external dock, Memory dock, AGP dock, and PCI dock information.
- Contains About, Voltage, Overclock, and Hardware Monitor Buttons for invoking respective panels.
- With a user-friendly Status Animation, it can represent 3 overclock percentage stages:

Man walking → overclock percentage from 100% ~ 110 %

Panther running → overclock percentage from 110% ~ 120%

Car racing → overclock percentage from 120% ~ above

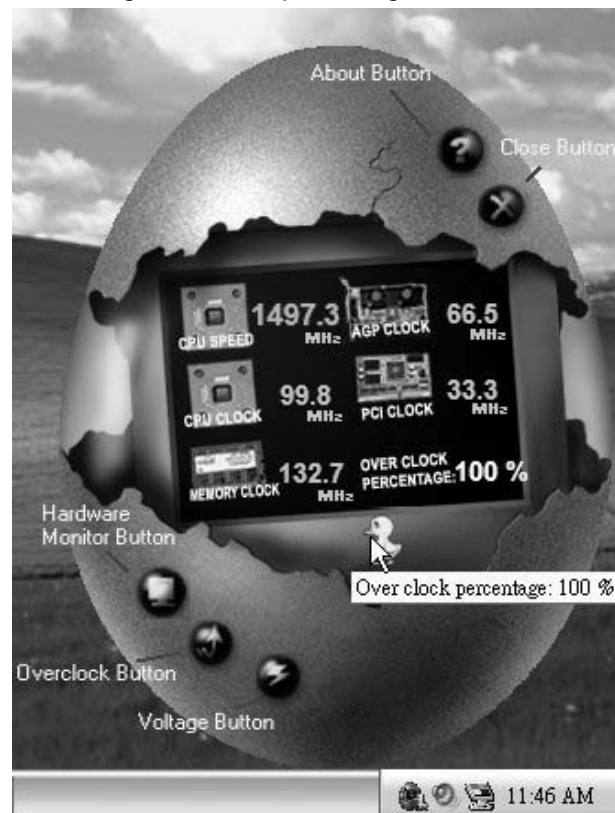

### 3. Voltage Panel

Click the Voltage button in Main Panel, the button will be highlighted and the Voltage Panel will slide out to up as the following figure.

In this panel, you can decide to increase CPU core voltage and Memory voltage or not. The default setting is "No". If you want to get the best performance of overlocking, we recommend you click the option "Yes".



#### 4. Overclock Panel

Click the Overclock button in Main Panel, the button will be highlighted and the Overclock Panel will slide out to left as the following figure.

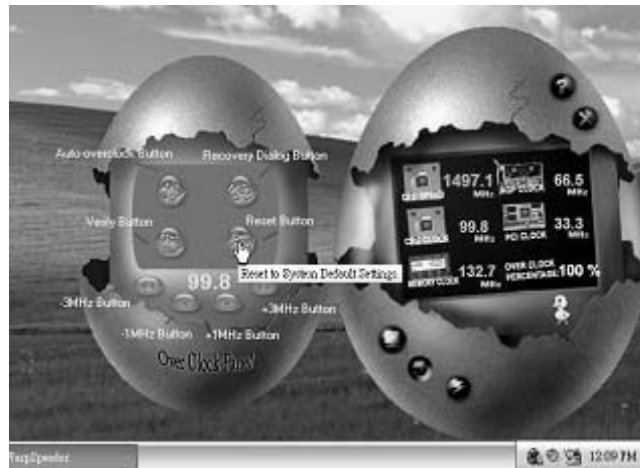

**Overclock Panel contains the these features:**

- “-3MHz button”, “-1MHz button”, “+1MHz button”, and “+3MHz button”:  
provide user the ability to do real-time overclock adjustment.

**Warning:**

Manually overclock is potentially dangerous, especially when the overlocking percentage is over 110 %. We strongly recommend you verify every speed you overclock by click the Verify button. Or, you can just click Auto overclock button and let [WarpSpeeder™] automatically gets the best result for you.

- “Recovery Dialog button”: Pop up the following dialog. Let user select a restoring way if system need to do a fail-safe reboot.



- c. “Auto-overclock button”: User can click this button and [WarpSpeeder™] will set the best and stable performance and frequency automatically. [WarpSpeeder™] utility will execute a series of testing until system fail. Then system will do fail-safe reboot by using Watchdog function. After reboot, the [WarpSpeeder™] utility will restore to the hardware default setting or load the verified best and stable frequency according to the Recovery Dialog's setting.
- d. “Verify button”: User can click this button and [WarpSpeeder™] will proceed a testing for current frequency. If the testing is ok, then the current frequency will be saved into system registry. If the testing fail, system will do a fail-safe rebooting. After reboot, the [WarpSpeeder™] utility will restore to the hardware default setting or load the verified best and stable frequency according to the Recovery Dialog's setting.

**Note:**

Because the testing programs, invoked in Auto-overclock and Verify, include DirectDraw, Direct3D and DirectShow tests, the DirectX 8.1 or newer runtime library is required. And please make sure our display card's color depth is High color (16 bit) or True color (24/32 bit) that is required for Direct3D rendering.

**5. Hardware Monitor Panel**

Click the Hardware Monitor button in Main Panel, the button will be highlighted and the Hardware Monitor panel will slide out to left as the following figure.

In this panel, you can get the real-time status information of your system. The information will be refreshed every 1 second.



## 6. About Panel

Click the “about” button in Main Panel, the button will be highlighted and the About Panel will slide out to up as the following figure.

In this panel, you can get model name and detail information in hints of all the chipset that are related to overclocking. You can also get the mainboard’s BIOS model and the Version number of [WarpSpeeder™] utility.

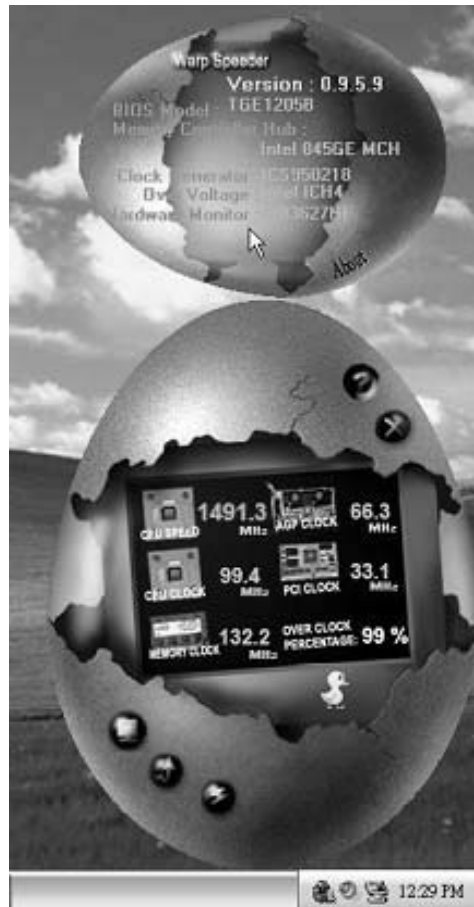

### Note:

Because the overclock, overvoltage, and hardware monitor features are controlled by several separate chipset, [WarpSpeeder™] divide these features to separate panels. If one chipset is not on board, the correlative button in Main panel will be disabled, but will not interfere other panels’ functions. This property can make [WarpSpeeder™] utility more robust.

**APPENDENCIES: SPEC IN OTHER LANGUAGE****GERMAN**

	<b>NF61VMicro AM2 SE</b>	<b>NF61SMicro AM2 SE</b>
CPU	Socket AM2 AMD Athlon 64 / Athlon 64 FX / Athlon 64 x2/ Sempron Prozessoren Unterstützt Hyper Transport und Cool'n'Quiet	Socket AM2 AMD Athlon 64 / Athlon 64 FX / Athlon 64 x2/ Sempron Prozessoren Unterstützt Hyper Transport und Cool'n'Quiet
FSB	Unterstützt HyperTransport mit einer Bandbreite von bis zu 1 GHz	Unterstützt HyperTransport mit einer Bandbreite von bis zu 1 GHz
Chipsatz	MCP61V (GeForce 6100-400)	MCP61S (GeForce 6100-405)
Super E/A	ITE 8716F Bietet die häufig verwendeten alten Super E/A-Funktionen. Low Pin Court-Schnittstelle	ITE 8716F Bietet die häufig verwendeten alten Super E/A-Funktionen. Low Pin Court-Schnittstelle
Arbeitsspeicher	DDR2 DIMM-Steckplätze x 2 Jeder DIMM unterstützt 256/512MB & 1GB DDR2. Max. 2GB Arbeitsspeicher Dual-Kanal DDR2 Speichermodul Unterstützt DDR2 400 / 533 / 667 / 800 registrierte	DDR2 DIMM-Steckplätze x 2 Jeder DIMM unterstützt 256/512MB & 1GB DDR2. Max. 2GB Arbeitsspeicher Dual-Kanal DDR2 Speichermodul Unterstützt DDR2 400 / 533 / 667 / 800 registrierte
Grafik	Integrierter MCP61V Chipsatz Max. 256MB gemeinsam benutzter Videospeicher	Integrierter MCP61S Chipsatz Max. 256MB gemeinsam benutzter Videospeicher
IDE	Integrierter IDE-Controller Ultra DMA 33 / 66 / 100 / 133 Bus Master-Modus Unterstützt PIO-Modus 0~4,	Integrierter IDE-Controller Ultra DMA 33 / 66 / 100 / 133 Bus Master-Modus Unterstützt PIO-Modus 0~4,
SATA II	Integrierter Serial ATA-Controller Datenübertragungsraten bis zu 3Gb/s Konform mit der SATA-Spezifikation Version 2.0.	Integrierter Serial ATA-Controller Datenübertragungsraten bis zu 3Gb/s Konform mit der SATA-Spezifikation Version 2.0.
LAN	Realtek 8201CL PHY 10 / 100 Mb/s Auto-Negotiation	Realtek 8201CL PHY 10 / 100 Mb/s Auto-Negotiation
Audio-Codec	ALC861VD(VER 6.X) / ALC888(VER 5.X) 5.1-Kanal-Audioausgabe (VER 6.X) 7.1-Kanal-Audioausgabe (VER 5.X) Unterstützt Intel High-Definition Audio	ALC861VD(VER 6.X) / ALC888(VER 5.X) 5.1-Kanal-Audioausgabe (VER 6.X) 7.1-Kanal-Audioausgabe (VER 5.X) Unterstützt Intel High-Definition Audio

NF61V Micro AM2 SE/NF61S Micro AM2 SE

	NF61V Micro AM2 SE		NF61S Micro AM2 SE	
Steckplätze	PCI-Steckplatz	x2	PCI-Steckplatz	x2
	PCI Express x16 Steckplatz (x1)	x1	PCI Express x16 Steckplatz (x8)	x1
	PCI Express x 1-Steckplatz	x1	PCI Express x 1-Steckplatz	x1
Onboard-Anschluss	Diskettenlaufwerkanschluss	x1	Diskettenlaufwerkanschluss	x1
	IDE-Anschluss	x1	IDE-Anschluss	x1
	SATA2-Anschluss	x2	SATA2-Anschluss	x2
	Fronttafelanschluss	x1	Fronttafelanschluss	x1
	Front-Audioanschluss	x1	Front-Audioanschluss	x1
	CD-IN-Anschluss	x1	CD-IN-Anschluss	x1
	S/PDIF- Ausgangsanschluss	x1	S/PDIF- Ausgangsanschluss	x1
	S/PDIF Eingangsanschluss (optional)	x1	S/PDIF Eingangsanschluss (optional)	x1
	CPU-Lüfter-Sockel	x1	CPU-Lüfter-Sockel	x1
	System-Lüfter-Sockel	x1	System-Lüfter-Sockel	x1
	"CMOS löschen"-Sockel	x1	"CMOS löschen"-Sockel	x1
	USB-Anschluss	x2	USB-Anschluss	x2
	Druckeranschluss-Anschluss	x1	Druckeranschluss-Anschluss	x1
"Gehäuse offen"-Sockel(optional)	x1	"Gehäuse offen"-Sockel(optional)	x1	
Stromanschluss (24-polig)	x1	Stromanschluss (24-polig)	x1	
Stromanschluss (4-polig)	x1	Stromanschluss (4-polig)	x1	
Rückseiten-E/A	PS/2-Tastatur	x1	PS/2-Tastatur	x1
	PS/2-Maus	x1	PS/2-Maus	x1
	Serieller Anschluss	x1	Serieller Anschluss	x1
	VGA-Anschluss	x1	VGA-Anschluss	x1
	LAN-Anschluss	x1	LAN-Anschluss	x1
	USB-Anschluss	x4	USB-Anschluss	x4
	Audioanschluss (Ver 6.x)	x3	Audioanschluss (Ver 6.x)	x3
Audioanschluss (Ver 5.x)	x6	Audioanschluss (Ver 5.x)	x6	
Platinengröße.	207 mm (B) X 244 mm (L)		207 mm (B) X 244 mm (L)	
Sonderfunktionen	NVIDIA nTune		NVIDIA nTune	
	Unterstützt RAID 0 / 1		Unterstützt RAID 0 / 1	
OS-Unterstützung	Windows 2000 / XP / VISTA Biostar behält sich das Recht vor, ohne Ankündigung die Unterstützung für ein Betriebssystem hinzuzufügen oder zu entfernen.		Windows 2000 / XP / VISTA Biostar behält sich das Recht vor, ohne Ankündigung die Unterstützung für ein Betriebssystem hinzuzufügen oder zu entfernen.	

## FRANCE

	NF61V Micro AM2 SE	NF61S Micro AM2 SE
UC	Socket AM2 Processeurs AMD Athlon 64 / Athlon 64 FX / Athlon 64 x2/ Sempron Prend en charge Hyper Transport et Cod'nQuiet	Socket AM2 Processeurs AMD Athlon 64 / Athlon 64 FX / Athlon 64 x2/ Sempron Prend en charge Hyper Transport et Cod'nQuiet
Bus frontal	Prend en charge Hyper Transport jusqu'à une bande passante de 1 GHz	Prend en charge Hyper Transport jusqu'à une bande passante de 1 GHz
Chipset	MCP61V ( GeForce 6100-400)	MCP61S ( GeForce 6100-405)
Super E/S	ITE 8716F Fournit la fonctionnalité de Super E/S patrimoniales la plus utilisée. Interface à faible compte de broches	ITE 8716F Fournit la fonctionnalité de Super E/S patrimoniales la plus utilisée. Interface à faible compte de broches
Mémoire principale	Fentes DDR2 DIMM x 2 Chaque DIMM prend en charge des DDR2 de 256/512 Mo et 1Go Capacité mémoire maximale de 2 Go Module de mémoire DDR2 à mode à double voie Prend en charge la DDR2 400 / 533 / 667 / 800	Fentes DDR2 DIMM x 2 Chaque DIMM prend en charge des DDR2 de 256/512 Mo et 1Go Capacité mémoire maximale de 2 Go Module de mémoire DDR2 à mode à double voie Prend en charge la DDR2 400 / 533 / 667 / 800
Graphiques	Intégré dans la chipset MCP61V Mémoire vidéo partagée maximale de 256 Mo	Intégré dans la chipset MCP61S Mémoire vidéo partagée maximale de 256 Mo
IDE	Contrôleur IDE intégré Mode principale de Bus Ultra DMA 33/ 66 / 100/ 133 Prend en charge le mode PIO 0~4,	Contrôleur IDE intégré Mode principale de Bus Ultra DMA 33/ 66 / 100/ 133 Prend en charge le mode PIO 0~4,
SATA II	Contrôleur Serial ATA intégré : Taux de transfert jusqu'à 3 Go/s. Conforme à la spécification SATA Version 2.0	Contrôleur Serial ATA intégré : Taux de transfert jusqu'à 3 Go/s. Conforme à la spécification SATA Version 2.0
LAN	Realtek 8201CLPHY 10 / 100 Mb/s négociation automatique	Realtek 8201CLPHY 10 / 100 Mb/s négociation automatique
Codec audio	ALC861VD(VER 6.X) / ALC888(VER 5.X) Sortie audio à 5.1 voies (VER 6.X) Sortie audio à 7.1 voies (VER 5.X) Prise en charge de l'audio haute définition Intel	ALC861VD(VER 6.X) / ALC888(VER 5.X) Sortie audio à 5.1 voies (VER 6.X) Sortie audio à 7.1 voies (VER 5.X) Prise en charge de l'audio haute définition Intel
Fentes	Fente PCI x2 Slot PCI Express x16 (x1) x1 Slot PCI Express x 1 x1	Fente PCI x2 Slot PCI Express x16 (x8) x1 Slot PCI Express x 1 x1



NF61V Micro AM2 SE/NF61S Micro AM2 SE

	NF61V Micro AM2 SE	NF61S Micro AM2 SE		
Connecteur embarqué	Connecteur de disquette	x1	Connecteur de disquette	x1
	Connecteur IDE	x1	Connecteur IDE	x1
	Connecteur SATA2	x2	Connecteur SATA2	x2
	Connecteur du panneau avant	x1	Connecteur du panneau avant	x1
	Connecteur Audio du panneau avant	x1	Connecteur Audio du panneau avant	x1
	Connecteur d'entrée CD	x1	Connecteur d'entrée CD	x1
	Connecteur de sortie S/PDIF	x1	Connecteur de sortie S/PDIF	x1
	Connecteur d'entrée S/PDIF(en option)	x1	Connecteur d'entrée S/PDIF(en option)	x1
	Embase de ventilateur UC	x1	Embase de ventilateur UC	x1
	Embase de ventilateur système	x1	Embase de ventilateur système	x1
	Embase d'effacement CMOS	x1	Embase d'effacement CMOS	x1
	Connecteur USB	x2	Connecteur USB	x2
	Connecteur de Port d'imprimante	x1	Connecteur de Port d'imprimante	x1
	Embase d'ouverture de châssis(en option)	x1	Embase d'ouverture de châssis(en option)	x1
	Connecteur d'alimentation (24 broches)	x1	Connecteur d'alimentation (24 broches)	x1
Connecteur d'alimentation (4 broches)	x1	Connecteur d'alimentation (4 broches)	x1	
E/S du panneau arrière	Clavier PS/2	x1	Clavier PS/2	x1
	Souris PS/2	x1	Souris PS/2	x1
	Port série	x1	Port série	x1
	Port VGA	x1	Port VGA	x1
	Port LAN	x1	Port LAN	x1
	Port USB	x4	Port USB	x4
	Fiche audio (Ver 6.x)	x3	Fiche audio (Ver 6.x)	x3
Fiche audio (Ver 5.x)	x6	Fiche audio (Ver 5.x)	x6	
Dimensions de la carte	207 mm (l) X 244 mm (H)	207 mm (l) X 244 mm (H)		
Fonctionnalités spéciales	NVIDIA nTunes Prise en charge RAID 0 / 1	NVIDIA nTunes Prise en charge RAID 0 / 1		
Support SE	Windows 2000 / XP / VISTA Biostar se réserve le droit d'ajouter ou de supprimer le support de SE avec ou sans préavis.	Windows 2000 / XP / VISTA Biostar se réserve le droit d'ajouter ou de supprimer le support de SE avec ou sans préavis.		

**ITALIAN**

	<b>NF61VMicro AM2 SE</b>	<b>NF61S Micro AM2 SE</b>
CPU	Socket AM2 Processori AMD Athlon 64 / Athlon 64 FX / Athlon 64 x2/ Sempron Supporto di Hyper Transport e Cool'n'Quiet	Socket AM2 Processori AMD Athlon 64 / Athlon 64 FX / Athlon 64 x2/ Sempron Supporto di Hyper Transport e Cool'n'Quiet
FSB	Supporto di HyperTransport fino a 1 GHz di larghezza di banda	Supporto di HyperTransport fino a 1 GHz di larghezza di banda
Chipset	MCP61V ( GeForce 6100-400)	MCP61S ( GeForce 6100-405)
Super I/O	ITE 8716F Fornisce le funzionalità legacy Super I/O usate più comunemente. Interfaccia LPC (Low Pin Count)	ITE 8716F Fornisce le funzionalità legacy Super I/O usate più comunemente. Interfaccia LPC (Low Pin Count)
Memoria principale	Alloggi DIMM DDR 2 x 2 Ciascun DIMM supporta DDR 2 256/512MB e 1GB Capacità massima della memoria 2GB Modulo di memoria DDR2 a canale doppio Supporto di DDR2 400 / 533 / 667 / 800	Alloggi DIMM DDR 2 x 2 Ciascun DIMM supporta DDR 2 256/512MB e 1GB Capacità massima della memoria 2GB Modulo di memoria DDR2 a canale doppio Supporto di DDR2 400 / 533 / 667 / 800
Grafica	Integrata nel Chipset MCP61V La memoria video condivisa massima è di 256MB	Integrata nel Chipset MCP61S La memoria video condivisa massima è di 256MB
IDE	Controller IDE integrato Modalità Bus Master Ultra DMA 33 / 66 / 100 / 133 Supporto modalità PIO Mode 0-4	Controller IDE integrato Modalità Bus Master Ultra DMA 33 / 66 / 100 / 133 Supporto modalità PIO Mode 0-4
SATA II	Controller Serial ATA integrato Velocità di trasferimento dei dati fino a 3 Gb/s. Compatibile specifiche SATA Versione 2.0.	Controller Serial ATA integrato Velocità di trasferimento dei dati fino a 3 Gb/s. Compatibile specifiche SATA Versione 2.0.
LAN	Realtek 8201CLPHY Negoziazione automatica 10 / 100 Mb/s	Realtek 8201CLPHY Negoziazione automatica 10 / 100 Mb/s
Codec audio	ALC861VD(VER 6.X) / ALC888(VER 5.X) Uscita audio 5.1 canali (VER 6.X) Uscita audio 7.1 canali (VER 5.X) Supporto audio High-Definition (HD) Intel	ALC861VD(VER 6.X) / ALC888(VER 5.X) Uscita audio 5.1 canali (VER 6.X) Uscita audio 7.1 canali (VER 5.X) Supporto audio High-Definition (HD) Intel

NF61V Micro AM2 SE/NF61S Micro AM2 SE

	NF61V Micro AM2 SE	NF61S Micro AM2 SE
Alloggi	Alloggio PCI x2	Alloggio PCI x2
	Alloggio PCI Express x16 (x1) x1	Alloggio PCI Express x16 (x8) x1
	Alloggio PCI Express x1 x1	Alloggio PCI Express x1 x1
Connettori su scheda	Connettore floppy x1	Connettore floppy x1
	Connettore IDE x1	Connettore IDE x1
	Connettore SATA2 x2	Connettore SATA2 x2
	Connettore pannello frontale x1	Connettore pannello frontale x1
	Connettore audio frontale x1	Connettore audio frontale x1
	Connettore CD-in x1	Connettore CD-in x1
	Connettore output S/PDIF x1	Connettore output S/PDIF x1
	Connettore input S/PDIF (optional) x1	Connettore input S/PDIF (optional) x1
	Collettore ventolina CPU x1	Collettore ventolina CPU x1
	Collettore ventolina sistema x1	Collettore ventolina sistema x1
	Collettore cancellazione CMOS x1	Collettore cancellazione CMOS x1
	Connettore USB x2	Connettore USB x2
	Connettore Porta stampante x1	Connettore Porta stampante x1
	Collettore apertura telaio (optional) x1	Collettore apertura telaio (optional) x1
	Connettore alimentazione (24 pin) x1	Connettore alimentazione (24 pin) x1
	Connettore alimentazione (4 pin) x1	Connettore alimentazione (4 pin) x1
I/O pannello posteriore	Tastiera PS/2 x1	Tastiera PS/2 x1
	Mouse PS/2 x1	Mouse PS/2 x1
	Porta seriale x1	Porta seriale x1
	Porta VGA x1	Porta VGA x1
	Porta LAN x1	Porta LAN x1
	Porta USB x4	Porta USB x4
	Connettore audio (Ver 6.x) x3	Connettore audio (Ver 6.x) x3
Connettore audio (Ver 5.x) x6	Connettore audio (Ver 5.x) x6	
Dimensioni scheda	207 mm (larghezza) x 244 mm (altezza)	207 mm (larghezza) x 244 mm (altezza)
Caratteristiche speciali	nTunes NVIDIA Supporto RAID 0 / 1	nTunes NVIDIA Supporto RAID 0 / 1
Sistemi operativi supportati	Windows 2000 / XP / VISTA Biostar si riserva il diritto di aggiungere o rimuovere il supporto di qualsiasi sistema operativo senza preavviso.	Windows 2000 / XP / VISTA Biostar si riserva il diritto di aggiungere o rimuovere il supporto di qualsiasi sistema operativo senza preavviso.

**SPANISH**

	NF61V Micro AM2 SE	NF61S Micro AM2 SE
CPU	Conector AM2 Procesadores AMD Athlon 64 / Athlon 64 FX / Athlon 64 x2/ Sempron Soporta las tecnologías Hyper Transport y Cool'nQuiet	Conector AM2 Procesadores AMD Athlon 64 / Athlon 64 FX / Athlon 64 x2/ Sempron Soporta las tecnologías Hyper Transport y Cool'nQuiet
FSB	Admite HyperTransport con un ancho de banda de hasta 1 GHz	Admite HyperTransport con un ancho de banda de hasta 1 GHz
Conjunto de chips	MCP61V ( GeForce 6100-400)	MCP61S ( GeForce 6100-405)
Súper E/S	ITE 8716F Le ofrece las funcionalidades heredadas de uso más común Súper E/S. Interfaz de cuenta Low Pin	ITE 8716F Le ofrece las funcionalidades heredadas de uso más común Súper E/S. Interfaz de cuenta Low Pin
Memoria principal	Ranuras DIMM DDR2 x 2 Cada DIMM admite DDR de 256/512MB y 1GB Capacidad máxima de memoria de 2GB Módulo de memoria DDR2 de canal Doble Admite DDR2 de 400 / 533 / 667 / 800	Ranuras DIMM DDR2 x 2 Cada DIMM admite DDR de 256/512MB y 1GB Capacidad máxima de memoria de 2GB Módulo de memoria DDR2 de canal Doble Admite DDR2 de 400 / 533 / 667 / 800
Gráficos	Integrados en el conjunto de chips MCP61V Memoria máxima de vídeo compartida de 256MB	Integrados en el conjunto de chips MCP61S Memoria máxima de vídeo compartida de 256MB
IDE	Controlador IDE integrado Modo bus maestro Ultra DMA 33 / 66 / 100 / 133 Soporte los Modos PIO 0~4,	Controlador IDE integrado Modo bus maestro Ultra DMA 33 / 66 / 100 / 133 Soporte los Modos PIO 0~4,
SATA II	Controlador ATA Serie Integrado Tasas de transferencia de hasta 3 Gb/s. Compatible con la versión SATA 2.0.	Controlador ATA Serie Integrado Tasas de transferencia de hasta 3 Gb/s. Compatible con la versión SATA 2.0.
Red Local	Realtek 8201CL PHY Negociación de 10 / 100 Mb/s	Realtek 8201CL PHY Negociación de 10 / 100 Mb/s
Códecs de sonido	ALC861VD(VER 6.X) / ALC888(VER 5.X) Salida de sonido de 5.1 canales (VER 6X) Salida de sonido de 7.1 canales (VER 5X) Soporte de sonido Intel de Alta Definición	ALC861VD(VER 6.X) / ALC888(VER 5.X) Salida de sonido de 5.1 canales (VER 6X) Salida de sonido de 7.1 canales (VER 5X) Soporte de sonido Intel de Alta Definición

NF61V Micro AM2 SE/NF61S Micro AM2 SE

	NF61V Micro AM2 SE		NF61S Micro AM2 SE	
Ranuras	Ranura PCI	X2	Ranura PCI	X2
	Ranura PCI Express x16 (x1)	X1	Ranura PCI Express x16 (x8)	X1
	Ranura PCI express x 1	X1	Ranura PCI express x 1	X1
Conectores en placa	Conector disco flexible	X1	Conector disco flexible	X1
	Conector IDE	X1	Conector IDE	X1
	Conector SATA2	X2	Conector SATA2	X2
	Conector de panel frontal	X1	Conector de panel frontal	X1
	Conector de sonido frontal	X1	Conector de sonido frontal	X1
	Conector de entrada de CD	X1	Conector de entrada de CD	X1
	Conector de salida S/PDIF	X1	Conector de salida S/PDIF	X1
	Conector de entrada S/PDIF (opcional)	X1	Conector de entrada S/PDIF (opcional)	X1
	Cabecera de ventilador de CPU	X1	Cabecera de ventilador de CPU	X1
	Cabecera de ventilador de sistema	X1	Cabecera de ventilador de sistema	X1
	Cabecera de borrado de CMOS	X1	Cabecera de borrado de CMOS	X1
	Conector USB	X2	Conector USB	X2
	Conector Puerto de impresora	X1	Conector Puerto de impresora	X1
	Cabecera de chasis abierto (opcional)	X1	Cabecera de chasis abierto (opcional)	X1
Conector de alimentación (24 patillas)	X1	Conector de alimentación (24 patillas)	X1	
Conector de alimentación (4 patillas)	X1	Conector de alimentación (4 patillas)	X1	
Panel trasero de E/S	Teclado PS/2	X1	Teclado PS/2	X1
	Ratón PS/2	X1	Ratón PS/2	X1
	Puerto serie	X1	Puerto serie	X1
	Puerto VGA	X1	Puerto VGA	X1
	Puerto de red local	X1	Puerto de red local	X1
	Puerto USB	X4	Puerto USB	X4
	Conector de sonido (Ver 6.x)	X3	Conector de sonido (Ver 6.x)	X3
Conector de sonido (Ver 5.x)	X6	Conector de sonido (Ver 5.x)	X6	
Tamaño de la placa	207 mm. (A) X 244 Mm. (H)		207 mm. (A) X 244 Mm. (H)	
Funciones especiales	NVIDIA nTunes Admite RAID 0 / 1		NVIDIA nTunes Admite RAID 0 / 1	
Soporte de sistema operativo	Windows 2000 / XP / VISTA Biosstar se reserva el derecho de añadir o retirar el soporte de cualquier SO con o sin aviso previo.		Windows 2000 / XP / VISTA Biosstar se reserva el derecho de añadir o retirar el soporte de cualquier SO con o sin aviso previo.	

## PORTUGUESE

	NF61V Micro AM2 SE	NF61S Micro AM2 SE
CPU	Socket AM2 Processadores AMD Athlon 64 / Athlon 64 FX / Athlon 64 x2 / Sempron Suporta as tecnologias Hyper Transport e Cool'nQuiet	Socket AM2 Processadores AMD Athlon 64 / Athlon 64 FX / Athlon 64 x2 / Sempron Suporta as tecnologias Hyper Transport e Cool'nQuiet
FSB	Suporta a tecnologia HyperTransport com uma largura de banda até 1 GHz	Suporta a tecnologia HyperTransport com uma largura de banda até 1 GHz
Chipset	MCP61V (GeForce 6100-400)	MCP61S (GeForce 6100-405)
Especificação do Super I/O	ITE 8716F Proporciona as funcionalidades mais utilizadas em termos da especificação Super I/O. Interface LPC (Low Pin Count).	ITE 8716F Proporciona as funcionalidades mais utilizadas em termos da especificação Super I/O. Interface LPC (Low Pin Count).
Memória principal	Ranuras DIMM DDR2 x 2 Cada módulo DIMM suporta uma memória DDR2 de 256/512 MB & 1 GB Capacidade máxima de memória: 2 GB Módulo de memória DDR2 de canal duplo Suporta módulos DDR2 400 / 533 / 667 / 800	Ranuras DIMM DDR2 x 2 Cada módulo DIMM suporta uma memória DDR2 de 256/512 MB & 1 GB Capacidade máxima de memória: 2 GB Módulo de memória DDR2 de canal duplo Suporta módulos DDR2 400 / 533 / 667 / 800
Placa gráfica	Integrada no chipset MCP61V Memória de vídeo máxima partilhada: 256 MB	Integrada no chipset MCP61S Memória de vídeo máxima partilhada: 256 MB
IDE	Controlador IDE integrado Modo Bus master Ultra DMA 33 / 66 / 100 / 133 Suporta o modo PIO 0~4.	Controlador IDE integrado Modo Bus master Ultra DMA 33 / 66 / 100 / 133 Suporta o modo PIO 0~4.
SATA II	Controlador Serial ATA integrado Velocidades de transmissão de dados até 3 Gb/s. Compatibilidade com a especificação SATA versão 2.0.	Controlador Serial ATA integrado Velocidades de transmissão de dados até 3 Gb/s. Compatibilidade com a especificação SATA versão 2.0.
LAN	Realtek 8201CL PHY Auto negociação de 10 / 100 Mb/s	Realtek 8201CL PHY Auto negociação de 10 / 100 Mb/s
Codec de som	ALC861VD (VER 6.X) / ALC888 (VER 5.X) Saída de áudio de 5.1 canais (VER 6.X) Saída de áudio de 7.1 canais (VER 5.X) Suporta a especificação Intel High-Definition Audio	ALC861VD (VER 6.X) / ALC888 (VER 5.X) Saída de áudio de 5.1 canais (VER 6.X) Saída de áudio de 7.1 canais (VER 5.X) Suporta a especificação Intel High-Definition Audio

NF61V Micro AM2 SE/NF61S Micro AM2 SE

	NF61V Micro AM2 SE		NF61S Micro AM2 SE	
Ranhuras	Ranhura PCI	x2	Ranhura PCI	x2
	Ranhura PCI Express x16 (x1)	x1	Ranhura PCI Express x16 (x8)	x1
	Ranhura PCI Express x 1	x1	Ranhura PCI Express x 1	x1
Conectores na placa	Conector da unidade de disquetes	x1	Conector da unidade de disquetes	x1
	Conector IDE	x1	Conector IDE	x1
	Conector SATA2	x2	Conector SATA2	x2
	Conector do painel frontal	x1	Conector do painel frontal	x1
	Conector de áudio frontal	x1	Conector de áudio frontal	x1
	Conector para entrada de CDs	x1	Conector para entrada de CDs	x1
	Conector de saída S/PDIF	x1	Conector de saída S/PDIF	x1
	Conector de entrada S/PDIF (opcional)	x1	Conector de entrada S/PDIF (opcional)	x1
	Conector da ventoinha da CPU	x1	Conector da ventoinha da CPU	x1
	Conector da ventoinha do sistema	x1	Conector da ventoinha do sistema	x1
	Conector para limpeza do CMOS	x1	Conector para limpeza do CMOS	x1
	Conector USB	x2	Conector USB	x2
	Conector da para impressora	x1	Conector da para impressora	x1
	Conector para detecção da abertura do chassis (opcional)	x1	Conector para detecção da abertura do chassis (opcional)	x1
	Conector de alimentação (24 pinos)	x1	Conector de alimentação (24 pinos)	x1
	Conector de alimentação (4 pinos)	x1	Conector de alimentação (4 pinos)	x1
Entradas/Saídas no painel traseiro	Teclado PS/2	x1	Teclado PS/2	x1
	Rato PS/2	x1	Rato PS/2	x1
	Porta série	x1	Porta série	x1
	Porta VGA	x1	Porta VGA	x1
	Porta LAN	x1	Porta LAN	x1
	Porta USB	x4	Porta USB	x4
	Tomada de áudio (Ver 6.x)	x3	Tomada de áudio (Ver 6.x)	x3
Tomada de áudio (Ver 5.x)	x6	Tomada de áudio (Ver 5.x)	x6	
Tamanho da placa	207 mm (L) X 244 mm (A)		207 mm (L) X 244 mm (A)	
Características especiais	nTunes da NVIDIA Suporta as funções RAID 0 / 1		nTunes da NVIDIA Suporta as funções RAID 0 / 1	
Sistemas operativos suportados	Windows 2000 / XP / VISTA A Biostar reserva-se o direito de adicionar ou remover suporte para qualquer sistema operativo com ou sem aviso prévio.		Windows 2000 / XP / VISTA A Biostar reserva-se o direito de adicionar ou remover suporte para qualquer sistema operativo com ou sem aviso prévio.	

**POLISH**

	NF61VMicro AM2 SE	NF61SMicro AM2 SE
Procesor	Socket AM2 AMD Athlon 64 / Athlon 64 FX / Athlon 64 x2/ Sempron Procesory Obsługa Hyper Transport oraz Cool'n'Quiet	Socket AM2 AMD Athlon 64 / Athlon 64 FX / Athlon 64 x2/ Sempron Procesory Obsługa Hyper Transport oraz Cool'n'Quiet
FSB	Obsługa HyperTransport o szerokości pasma do 10.66 GHz	Obsługa HyperTransport o szerokości pasma do 10.66 GHz
Chipset	MCP61V ( GeForce 6100-400)	MCP61S ( GeForce 6100-405)
Pamięć główna	Gniazda DDR2 DIMM x 2 Każde gniazdo DIMM obsługuje moduły 256/512MB oraz 1GB DDR2 Maks. wielkość pamięci 2GB Moduł pamięci DDR2 z trybem podwójnego kanału Obsługa DDR2 400 / 533 / 667 / 800	Gniazda DDR2 DIMM x 2 Każde gniazdo DIMM obsługuje moduły 256/512MB oraz 1GB DDR2 Maks. wielkość pamięci 2GB Moduł pamięci DDR2 z trybem podwójnego kanału Obsługa DDR2 400 / 533 / 667 / 800
Super I/O	ITE 8716F Zapewnia najbardziej powszechne funkcje Super I/O. Interfejs Low Pin Court	ITE 8716F Zapewnia najbardziej powszechne funkcje Super I/O. Interfejs Low Pin Court
Grafika	Zintegrowana w chipsecie MCP61V Maks. wielkość współdzielonej pamięci video wynosi 256MB	Zintegrowana w chipsecie MCP61S Maks. wielkość współdzielonej pamięci video wynosi 256MB
IDE	Zintegrowany kontroler IDE Ultra DMA 33 / 66 / 100 / 133 Tryb Bus Master obsługa PIO tryb 0~4	Zintegrowany kontroler IDE Ultra DMA 33 / 66 / 100 / 133 Tryb Bus Master obsługa PIO tryb 0~4
SATA II	Zintegrowany kontroler Serial ATA Transfer danych do 3 Gb/s. Zgodność ze specyfikacją SATA w wersji 2.0.	Zintegrowany kontroler Serial ATA Transfer danych do 3 Gb/s. Zgodność ze specyfikacją SATA w wersji 2.0.
LAN	Realtek 8201CL PHY 10 / 100 Mb/s z automatyczną negocjacją szybkości	Realtek 8201CL PHY 10 / 100 Mb/s z automatyczną negocjacją szybkości
Kodek dźwiękowy	ALC861VD(VER 6.X) / ALC888(VER 5.X) 5.1 kanałowe wyjście audio (VER 6.X) 7.1 kanałowe wyjście audio (VER 5.X) Obsługa Intel High-Definition Audio	ALC861VD(VER 6.X) / ALC888(VER 5.X) 5.1 kanałowe wyjście audio (VER 6.X) 7.1 kanałowe wyjście audio (VER 5.X) Obsługa Intel High-Definition Audio



NF61V Micro AM2 SE/NF61S Micro AM2 SE

	NF61V Micro AM2 SE		NF61S Micro AM2 SE	
Gniazda	Gniazdb PCI	x2	Gniazdb PCI	x2
	Gniazdb PCI Express x16 (x1)	x1	Gniazdb PCI Express x16 (x8)	x1
	Gniazdb PCI Express x 1	x1	Gniazdb PCI Express x 1	x1
Złącza wbudowane	Złącze napędu dyskietek	x1	Złącze napędu dyskietek	x1
	Złącze IDE	x1	Złącze IDE	x1
	Złącze SATA2	x2	Złącze SATA2	x2
	Złącze panela przedniego	x1	Złącze panela przedniego	x1
	Przednie złącze audio	x1	Przednie złącze audio	x1
	Złącze wejścia CD	x1	Złącze wejścia CD	x1
	Złącze wyjścia S/PDIF	x1	Złącze wyjścia S/PDIF	x1
	Złącze wejścia S/PDIF (opcja)	x1	Złącze wejścia S/PDIF (opcja)	x1
	Złącze głośkowe wentylatora procesora	x1	Złącze głośkowe wentylatora procesora	x1
	Złącze głośkowe wentylatora systemowego	x1	Złącze głośkowe wentylatora systemowego	x1
	Złącze głośkowe kasowania CMOS	x1	Złącze głośkowe kasowania CMOS	x1
	Złącze USB	x2	Złącze USB	x2
	Złącze Port drukarki	x1	Złącze Port drukarki	x1
Złącze głośkowe otwarcia obudowy (opcja)	x1	Złącze głośkowe otwarcia obudowy (opcja)	x1	
Złącze zasilania (24 pinowe)	x1	Złącze zasilania (24 pinowe)	x1	
Złącze zasilania (4 pinowe)	x1	Złącze zasilania (4 pinowe)	x1	
Back Panel I/O	Klawiatura PS/2	x1	Klawiatura PS/2	x1
	Mysz PS/2	x1	Mysz PS/2	x1
	Port szeregowy	x1	Port szeregowy	x1
	Port VGA	x1	Port VGA	x1
	Port LAN	x1	Port LAN	x1
	Port USB	x4	Port USB	x4
	Gniazdb audio (Ver 6.x)	x3	Gniazdb audio (Ver 6.x)	x3
Gniazdb audio (Ver 5.x)	x6	Gniazdb audio (Ver 5.x)	x6	
Wymiary płyty	207 mm (S) X 244 mm (W)		207 mm (S) X 244 mm (W)	
Funkcje specjalne	NVIDIA nTunes.		NVIDIA nTunes.	
	Obsługa RAID 0 / 1		Obsługa RAID 0 / 1	
Obsługa systemu operacyjnego	Windows 2000 / XP / VISTA Biostar zastrzega sobie prawo dodawania lub odwoływania obsługi dowolnego systemu operacyjnego bez powiadomienia.		Windows 2000 / XP / VISTA Biostar zastrzega sobie prawo dodawania lub odwoływania obsługi dowolnego systemu operacyjnego bez powiadomienia.	

## RUSSIAN

	NF61VMicro AM2 SE	NF61S Micro AM2 SE
CPU (центральный процессор)	Гнездо AM2 Процессоры AMD Athlon 64 / Athlon 64 FX / Athlon 64X2 Поддержка Hyper Transport и Cool'n'Quiet	Гнездо AM2 Процессоры AMD Athlon 64 / Athlon 64 FX / Athlon 64X2 Поддержка Hyper Transport и Cool'n'Quiet
FSB	Поддержка HyperTransport с пропускной способностью до1ГГц	Поддержка HyperTransport с пропускной способностью до1ГГц
Набор микросхем	MCP61V ( GeForce 6100-400)	MCP61S ( GeForce 6100-405)
Основная память	Слоты DDR2 DIMM x 2 Каждый модуль DIMM поддерживает 256/512МБ & 1ГБ DDR2 Максимальная ёмкость памяти 2 ГБ Модуль памяти с двухканальным режимом DDR2 Поддержка DDR2 400 / 533 / 667 / 800	Слоты DDR2 DIMM x 2 Каждый модуль DIMM поддерживает 256/512МБ & 1ГБ DDR2 Максимальная ёмкость памяти 2 ГБ Модуль памяти с двухканальным режимом DDR2 Поддержка DDR2 400 / 533 / 667 / 800
Super I/O	ITE 8716F Обеспечивает наиболее используемые действующие функциональные возможности Super I/O. Интерфейс с низким количеством выводов	ITE 8716F Обеспечивает наиболее используемые действующие функциональные возможности Super I/O. Интерфейс с низким количеством выводов
Графика	Встроенная в набор микросхем MCP61V Максимальная совместно используемая видео память составляет 256 МБ	Встроенная в набор микросхем MCP61S Максимальная совместно используемая видео память составляет 256 МБ
IDE	Встроенное устройство управления встроенными интерфейсами устройств Режим "хвояина" шины Ultra DMA 33 / 66 / 100 / 133 Поддержка режима PIO 0~4,	Встроенное устройство управления встроенными интерфейсами устройств Режим "хвояина" шины Ultra DMA 33 / 66 / 100 / 133 Поддержка режима PIO 0~4,
SATA II	Встроенное последовательное устройство управления ATA скорость передачи данных до 3 гигабит/с. Соответствие спецификации SATA версия 2.0	Встроенное последовательное устройство управления ATA скорость передачи данных до 3 гигабит/с. Соответствие спецификации SATA версия 2.0
Локальная сеть	Realtek 8201CL PHY Автоматическое согласование 10 / 100 Мб/с	Realtek 8201CL PHY Автоматическое согласование 10 / 100 Мб/с
Звуковой кодек	ALC861VD(VER 6.X) / ALC888(VER 5.X) 5.1канальный звуковой выход (VER 6.X) 7.1канальный звуковой выход (VER 5.X) Звуковая поддержка Intel High-Definition	ALC861VD(VER 6.X) / ALC888(VER 5.X) 5.1канальный звуковой выход (VER 6.X) 7.1канальный звуковой выход (VER 5.X) Звуковая поддержка Intel High-Definition

NF61V Micro AM2 SE/NF61S Micro AM2 SE

	NF61V Micro AM2 SE		NF61S Micro AM2 SE	
Слоты	Слот PCI	x2	Слот PCI	x2
	Слот PCI Express x16 (x1)	x1	Слот PCI Express x16 (x8)	x1
	Слот PCI Express x 1	x1	Слот PCI Express x 1	x1
Встроенный разъем	Разъем НГМД	x1	Разъем НГМД	x1
	Разъем IDE	x1	Разъем IDE	x1
	Разъем SATA2	x2	Разъем SATA2	x2
	Разъем на лицевой панели	x1	Разъем на лицевой панели	x1
	Входной звуковой разъем	x1	Входной звуковой разъем	x1
	Разъем ввода для CD	x1	Разъем ввода для CD	x1
	Разъем вывода для S/PDIF	x1	Разъем вывода для S/PDIF	x1
	Разъем ввода для S/PDIF (дополнительно)	x1	Разъем ввода для S/PDIF (дополнительно)	x1
	Контактирующее приспособление вентилятора центрального процессора	x1	Контактирующее приспособление вентилятора центрального процессора	x1
	Контактирующее приспособление вентилятора системы	x1	Контактирующее приспособление вентилятора системы	x1
	Открытое контактирующее приспособление CMOS	x1	Открытое контактирующее приспособление CMOS	x1
	USB-разъем	x2	USB-разъем	x2
	Разъем Порт подключения принтера	x1	Разъем Порт подключения принтера	x1
	Шасси открытого контактирующего приспособления(дополнительно)	x1	Шасси открытого контактирующего приспособления(дополнительно)	x1
	Разъем питания (24 вывод)	x1	Разъем питания (24 вывод)	x1
Разъем питания (4 вывод)	x1	Разъем питания (4 вывод)	x1	
Задняя панель средств ввода-вывода	Клавиатура PS/2	x1	Клавиатура PS/2	x1
	Мышь PS/2	x1	Мышь PS/2	x1
	Последовательный порт	x1	Последовательный порт	x1
	Порт VGA	x1	Порт VGA	x1
	Порт LAN	x1	Порт LAN	x1
	USB-порт	x4	USB-порт	x4
	Гнездо для подключения наушников (Ver 6.x)	x3	Гнездо для подключения наушников (Ver 6.x)	x3
	Гнездо для подключения наушников (Ver 5.x)	x6	Гнездо для подключения наушников (Ver 5.x)	x6
Размер панели	207 мм (Ш) X 244 мм (В)		207 мм (Ш) X 244 мм (В)	
Специальные технические характеристики	NVIDIA nTunes Поддержка RAID 0/ 1		NVIDIA nTunes Поддержка RAID 0/ 1	
Поддержка OS	Windows 2000 / XP / VISTA Biostar сохраняет за собой право добавлять или удалять средства обеспечения для OS с или без предварительного уведомления.		Windows 2000 / XP / VISTA Biostar сохраняет за собой право добавлять или удалять средства обеспечения для OS с или без предварительного уведомления.	

## ARABIC

NF61S Micro AM2 SE	NF61VMicro AM2 SE	
AM2 مقبس AMD Athlon 64 / Athlon 64 FX / Athlon 64 x2/ Sempron Hyper Transport و Cod'nQuiet تدعم تقنية	AM2 مقبس AMD Athlon 64 / Athlon 64 FX / Athlon 64 x2/ Sempron Hyper Transport و Cod'nQuiet تدعم تقنية	وحدة المعالجة المركزية
تردد 1000 بتردد يصل إلى HyperTransport تدعم تقنية	تردد 1000 بتردد يصل إلى HyperTransport تدعم تقنية	النقل الأممي الجاني
MCP61S ( GeForce 6100-405)	MCP61V ( GeForce 6100-400)	مجموعة الشرح
عدد 2 فتحة DDR2 DIMM 256/512 سعة DDR2 تدعم ذاكرة من نوع DIMM تدعم كل قحة ميجا بايت و 1 جيجا بايت سعة ذاكرة قصوى 2 جيجا بايت مزوجة لفتحة DDR وحدة ذاكرة ساعات 2800 / 667 / 533 / 400 DDR تدعم الذاكرة من نوع ميجا بايت	عدد 2 فتحة DDR2 DIMM 256/512 سعة DDR2 تدعم ذاكرة من نوع DIMM تدعم كل قحة ميجا بايت و 1 جيجا بايت سعة ذاكرة قصوى 2 جيجا بايت مزوجة لفتحة DDR وحدة ذاكرة ساعات 2800 / 667 / 533 / 400 DDR تدعم الذاكرة من نوع ميجا بايت	الذاكرة الرئيسية
ITE 8716F الأكثر استخداماً، Super I/O توفر وظيفة Low Pin Count Interface تدعم تقنية	ITE 8716F الأكثر استخداماً، Super I/O توفر وظيفة Low Pin Count Interface تدعم تقنية	Super I/O
ميجا بايت 256 أقصى سعة للذاكرة للفيديو لمشوكة MCP61S منمجة في رقائق	ميجا بايت 256 أقصى سعة للذاكرة للفيديو لمشوكة MCP61V منمجة في رقائق	بطاقة الصوت
متكامل IDE متحكم Ultra DMA 33 / 66 / 100 / 133 نقل بتقنية وضع رئيسي PIO Mode 0~4 دعم وضع	متكامل IDE متحكم Ultra DMA 33 / 66 / 100 / 133 نقل بتقنية وضع رئيسي PIO Mode 0~4 دعم وضع	منفذ IDE
متكامل Serial ATA متحكم نقل لينكات بساعات تصل إلى 3 جيجا بايت/ثانية. الإصدار SATA مطابقة لمواصفات 2.0	متكامل Serial ATA متحكم نقل لينكات بساعات تصل إلى 3 جيجا بايت/ثانية. الإصدار SATA مطابقة لمواصفات 2.0	SATA II
Realtek 8201CL PHY تقوى ثنائي 100/10 ميجا بايت / ثنائي جيجا بايت/ثاني	Realtek 8201CL PHY تقوى ثنائي 100/10 ميجا بايت / ثنائي جيجا بايت/ثاني	شبكة داخلية
ALC861VD(VER 6.X) / ALC888(VER 5.X) 5. (VER 6.X) قنوات لخرج الصوت 1. 7. (VER 5.X) قنوات لخرج الصوت 1. Intel تدعم تقنية الصوت على التعريف من	ALC861VD(VER 6.X) / ALC888(VER 5.X) 5. (VER 6.X) قنوات لخرج الصوت 1. 7. (VER 5.X) قنوات لخرج الصوت 1. Intel تدعم تقنية الصوت على التعريف من	كوديك الصوت

NF61V Micro AM2 SE/NF61S Micro AM2 SE

NF61S Micro AM2 SE	NF61V Micro AM2 SE	
عدد 2	عدد 2	فتحة PCI
عدد 1	عدد 1	فتحة PCI Express x16 (x8)
عدد 1	عدد 1	فتحة PCI Express x1
عدد 1	عدد 1	مقذ محرك أقراص مرنة
عدد 1	عدد 1	مقذ IDE
عدد 2	عدد 2	مقذ SATA
عدد 1	عدد 1	مقذ اللوحة الأممية
عدد 1	عدد 1	مقذ الصوت الأممي
عدد 1	عدد 1	مقذ CD-IN
عدد 1	عدد 1	مقذ خرج S/PDIF
عدد 1	عدد 1	مقذ دخل S/PDIF (اختياري)
عدد 1	عدد 1	وصلة مروحة وحدة المعالجة المركزية
عدد 1	عدد 1	وصلة مروحة النظم
عدد 1	عدد 1	وصلة مسح CMOS
عدد 2	عدد 2	مقذ USB
عدد 1	عدد 1	مقذ طابعة
عدد 1	عدد 1	وصلة فتح الهيكل (اختياري)
عدد 1	عدد 1	مقذ توصيل الطاقة (24 دوس)
عدد 1	عدد 1	مقذ توصيل الطاقة (4 دبليوس)
عدد 1	عدد 1	لوحة مفاتيح PS/2
عدد 1	عدد 1	مؤس PS/2
عدد 1	عدد 1	مقذ تسلسلي
عدد 1	عدد 1	مقذ VGA
عدد 1	عدد 1	مقذ شبكة لتصل محلية
عدد 4	عدد 4	منافذ USB
عدد 3	عدد 3	مقيس صوت (Ver 6.x)
عدد 6	عدد 6	مقيس صوت (Ver 5.x)
		مزيا خاصة
		NVIDIA nTunes
		RAID 0 / 1 دعم ثقبية
		حجم اللوحة
		207 مم (عرض) X 244 مم (ارتفاع)
		دعم أنظمة لتشغيل
		Windows 2000 / XP / VISTA
		بخطا في اضافة أو ازالة لا دعم لأي نظام تشغيل باخطار Biostar تحتفظ أو بيون اخطار

## JAPANESE

	NF61VMicro AM2 SE	NF61S Micro AM2 SE
CPU	Socket AM2 AMD Athlon 64 / Athlon 64 FX / Athlon 64 x2 / Sempron プロセッサ ハイパートランスポートとクールアンドクワイアット をサポートします	Socket AM2 AMD Athlon 64 / Athlon 64 FX / Athlon 64 x2 / Sempron プロセッサ ハイパートランスポートとクールアンドクワイアット をサポートします
FSB	1 GHzのバンド幅までハイパートランスポートをサポ ートします	1 GHzのバンド幅までハイパートランスポートをサポ ートします
チップセット	MCP61V (GeForce 6100-400)	MCP61S (GeForce 6100-405)
メインメモリ	DDR2 DIMMスロット x 2 各DIMMは 256/512MB & 1GB DDR2をサポート 最大メモリ容量2GB デュアルチャンネルモードDDR2メモリモジュール DDR2 400 / 533 / 667 / 800をサポート	DDR2 DIMMスロット x 2 各DIMMは 256/512MB & 1GB DDR2をサポート 最大メモリ容量2GB デュアルチャンネルモードDDR2メモリモジュール DDR2 400 / 533 / 667 / 800をサポート
Super I/O	ITE 8716F もっとも一般に使用されるレガシーSuper I/O機能を 採用しています。 低ピンカウントインターフェイス	ITE 8716F もっとも一般に使用されるレガシーSuper I/O機能を 採用しています。 低ピンカウントインターフェイス
グラフィック ス	MCP61Vチップセットに統合 最大の共有ビデオメモリは256MBです	MCP61Sチップセットに統合 最大の共有ビデオメモリは256MBです
IDE	統合IDEコントローラ Ultra DMA 33 / 66 / 100 / 133バスマスタモード PIO Mode 0~4のサポート、	統合IDEコントローラ Ultra DMA 33 / 66 / 100 / 133バスマスタモード PIO Mode 0~4のサポート、
SATA II	統合シリアルATAコントローラ 最高3 Gb/秒のデータ転送速度 SATAバージョン2.0仕様に準拠。	統合シリアルATAコントローラ 最高3 Gb/秒のデータ転送速度 SATAバージョン2.0仕様に準拠。
LAN	Realtek 8201CL PHY 10 / 100 Mb/秒のオートネゴシエーション	Realtek 8201CL PHY 10 / 100 Mb/秒のオートネゴシエーション
サウンド Codec	ALC861VD(VER 6.X) / ALC888(VER 5.X) 5.1チャンネルオーディオアウト(VER 6.X) 7.1チャンネルオーディオアウト(VER 5.X) Intelハイデフィニションオーディオのサポート	ALC861VD(VER 6.X) / ALC888(VER 5.X) 5.1チャンネルオーディオアウト(VER 6.X) 7.1チャンネルオーディオアウト(VER 5.X) Intelハイデフィニションオーディオのサポート

NF61V Micro AM2 SE/NF61S Micro AM2 SE

NF61V Micro AM2 SE		NF61S Micro AM2 SE		
スロット	PCIスロット	x2	PCIスロット	x2
	PCI Express x16スロット (x1)	x1	PCI Express x16スロット (x8)	x1
	PCI Express x 1スロット	x1	PCI Express x 1スロット	x1
オンボードコネクタ	フロッピーコネクタ	x1	フロッピーコネクタ	x1
	IDEコネクタ	x1	IDEコネクタ	x1
	SATAコネクタ	x2	SATAコネクタ	x2
	フロントパネルコネクタ	x1	フロントパネルコネクタ	x1
	フロントオーディオコネクタ	x1	フロントオーディオコネクタ	x1
	CDインコネクタ	x1	CDインコネクタ	x1
	S/PDIFアウトコネクタ	x1	S/PDIFアウトコネクタ	x1
	S/PDIFインコネクタ (オプション)	x1	S/PDIFインコネクタ (オプション)	x1
	CPUファンヘッダ	x1	CPUファンヘッダ	x1
	システムファンヘッダ	x1	システムファンヘッダ	x1
	CMOS クリアヘッダ	x1	CMOS クリアヘッダ	x1
	USBコネクタ	x2	USBコネクタ	x2
	プリンタポートコネクタ	x1	プリンタポートコネクタ	x1
シャーシオープンヘッダ(オプション)	x1	シャーシオープンヘッダ(オプション)	x1	
電源コネクタ(24ピン)	x1	電源コネクタ(24ピン)	x1	
電源コネクタ(4ピン)	x1	電源コネクタ(4ピン)	x1	
背面パネル I/O	PS/2キーボード	x1	PS/2キーボード	x1
	PS/2マウス	x1	PS/2マウス	x1
	シリアルポート	x1	シリアルポート	x1
	VGAポート	x1	VGAポート	x1
	LANポート	x1	LANポート	x1
	USBポート	x4	USBポート	x4
	オーディオジャック (Ver 6.x)	x3	オーディオジャック (Ver 6.x)	x3
オーディオジャック (Ver 5.x)	x6	オーディオジャック (Ver 5.x)	x6	
ボードサイズ	207 mm (幅) X 244 mm (高さ)		207 mm (幅) X 244 mm (高さ)	
特殊機能	NVIDIA nTunes		NVIDIA nTunes	
	RAID 0 / 1 のサポート		RAID 0 / 1 のサポート	
OSサポート	Windows 2000 / XP / VISTA Bicstarは事前のサポートなしにOSサポートを追加または削除する権利を留保します。		Windows 2000 / XP / VISTA Bicstarは事前のサポートなしにOSサポートを追加または削除する権利を留保します。	

2006/10/30

**NF61V Micro AM2 SE / NF61S Micro AM2 SE  
BIOS Setup**

---

---

**Table of Contents**

<b>BIOS Setup</b> .....	<b>2</b>
<b>1 Main Menu</b> .....	<b>4</b>
<b>2 Standard CMOS Features</b> .....	<b>7</b>
<b>3 Advanced BIOS Features</b> .....	<b>9</b>
<b>4 Advanced Chipset Features</b> .....	<b>15</b>
<b>5 Integrated Peripherals</b> .....	<b>17</b>
<b>6 Power Management Setup</b> .....	<b>23</b>
<b>7 PnP/PCI Configurations</b> .....	<b>27</b>
<b>8 PC Health Status</b> .....	<b>29</b>
<b>9 Performance Booster Zone</b> .....	<b>31</b>



# **NF61V Micro AM2 SE / NF61S Micro AM2 SE BIOS Setup**

---

## **BIOS Setup**

### **Introduction**

The purpose of this manual is to describe the settings in the Award™ BIOS Setup program on this motherboard. The Setup program allows users to modify the basic system configuration and save these settings to CMOS RAM. The power of CMOS RAM is supplied by a battery so that it retains the Setup information when the power is turned off.

Basic Input-Output System (BIOS) determines what a computer can do without accessing programs from a disk. This system controls most of the input and output devices such as keyboard, mouse, serial ports and disk drives. BIOS activates at the first stage of the booting process, loading and executing the operating system. Some additional features, such as virus and password protection or chipset fine-tuning options are also included in BIOS.

The rest of this manual will to guide you through the options and settings in BIOS Setup.

### **Plug and Play Support**

This AWARD BIOS supports the Plug and Play Version 1.0A specification and ESCD (Extended System Configuration Data) write.

### **EPA Green PC Support**

This AWARD BIOS supports Version 1.03 of the EPA Green PC specification.

### **APM Support**

This AWARD BIOS supports Version 1.1&1.2 of the Advanced Power Management (APM) specification. Power management features are implemented via the System Management Interrupt (SMI). Sleep and Suspend power management modes are supported. Power to the hard disk drives and video monitors can also be managed by this AWARD BIOS.

### **ACPI Support**

Award ACPI BIOS support Version 1.0 of Advanced Configuration and Power interface specification (ACPI). It provides ASL code for power management and device configuration capabilities as defined in the ACPI specification, developed by Microsoft, Intel and Toshiba.

## **NF61V Micro AM2 SE / NF61S Micro AM2 SE BIOS Setup**

---

### **PCI Bus Support**

This AWARD BIOS also supports Version 2.1 of the Intel PCI (Peripheral Component Interconnect) local bus specification.

### **DRAM Support**

DDR SDRAM (Double Data Rate Synchronous DRAM) is supported.

### **Supported CPUs**

This AWARD BIOS supports the AMD CPU.

### **Using Setup**

Use the arrow keys to highlight items in most of the place, press <Enter> to select, use the <PgUp> and <PgDn> keys to change entries, press <F1> for help and press <Esc> to quit. The following table provides more detail about how to navigate in the Setup program by using the keyboard.

<b>Keystroke</b>	<b>Function</b>
Up arrow	Move to previous item
Down arrow	Move to next item
Left arrow	Move to the item on the left (menu bar)
Right arrow	Move to the item on the right (menu bar)
Move Enter	Move to the item you desired
PgUp key	Increase the numeric value or make changes
PgDn key	Decrease the numeric value or make changes
+ Key	Increase the numeric value or make changes
- Key	Decrease the numeric value or make changes
Esc key	Main Menu – Quit and not save changes into CMOS Status Page Setup Menu and Option Page Setup Menu – Exit Current page and return to Main Menu
F1 key	General help on Setup navigation keys
F5 key	Load previous values from CMOS
F7 key	Load the optimized defaults
F10 key	Save all the CMOS changes and exit

## NF61V Micro AM2 SE / NF61S Micro AM2 SE BIOS Setup

---

### 1 Main Menu

Once you enter Award BIOS™ CMOS Setup Utility, the Main Menu will appear on the screen. The Main Menu allows you to select from several setup functions. Use the arrow keys to select among the items and press <Enter> to accept and enter the sub-menu.

**!! WARNING !!**

For better system performance, the BIOS firmware is being continuously updated. The BIOS information described in this manual (**Figure 1, 2, 3, 4, 5, 6, 7, 8, 9**) is for your reference only. The actual BIOS information and settings on board may be slightly different from this manual.

■ **Figure 1: Main Menu**



#### Standard CMOS Features

This submenu contains industry standard configurable options.

#### Advanced BIOS Features

This submenu allows you to configure advanced features of the BIOS.

## ***NF61V Micro AM2 SE / NF61S Micro AM2 SE BIOS Setup***

---

### **Advanced Chipset Features**

This submenu allows you to configure special chipset features.

### **Integrated Peripherals**

This submenu allows you to configure certain IDE hard drive options and Programmed Input/ Output features.

### **Power Management Setup**

This submenu allows you to configure the power management features.

### **PnP/PCI Configurations**

This submenu allows you to configure certain “Plug and Play” and PCI options.

### **PC Health Status**

This submenu allows you to monitor the hardware of your system.

### **Performance Booster Zone**

This submenu allows you to change CPU Vcore Voltage and CPU/PCI clock.  
(However, we suggest you to use the default setting. Changing the voltage and clock improperly may damage the CPU or M/B!)

### **Load Optimized Defaults**

This selection allows you to reload the BIOS when problem occurs during system booting sequence. These configurations are factory settings optimized for this system. A confirmation message will be displayed before defaults are set.



Load Optimized Defaults (Y/N)? N

### **Set Supervisor Password**

Setting the supervisor password will prohibit everyone except the supervisor from making changes using the CMOS Setup Utility. You will be prompted with to enter a password.



Enter Password:

## ***NF61V Micro AM2 SE / NF61S Micro AM2 SE BIOS Setup***

---

### **Set User Password**

If the Supervisor Password is not set, then the User Password will function in the same way as the Supervisor Password. If the Supervisor Password is set and the User Password is set, the “User” will only be able to view configurations but will not be able to change them.

Enter Password:

### **Save & Exit Setup**

Save all configuration changes to CMOS (memory) and exit setup. Confirmation message will be displayed before proceeding.

SAVE to CMOS and EXIT (Y/N)? Y

### **Exit Without Saving**

Abandon all changes made during the current session and exit setup. Confirmation message will be displayed before proceeding.

Quit Without Saving (Y/N)? N

### **Upgrade BIOS**

This submenu allows you to upgrade bios.

BIOS UPDATE UTILITY (Y/N)? N

# NF61V Micro AM2 SE / NF61S Micro AM2 SE BIOS Setup

---

## 2 Standard CMOS Features

The items in Standard CMOS Setup Menu are divided into several categories. Each category includes no, one or more than one setup items. Use the arrow keys to highlight the item and then use the <PgUp> or <PgDn> keys to select the value you want in each item.

■ **Figure 2: Standard CMOS Setup**

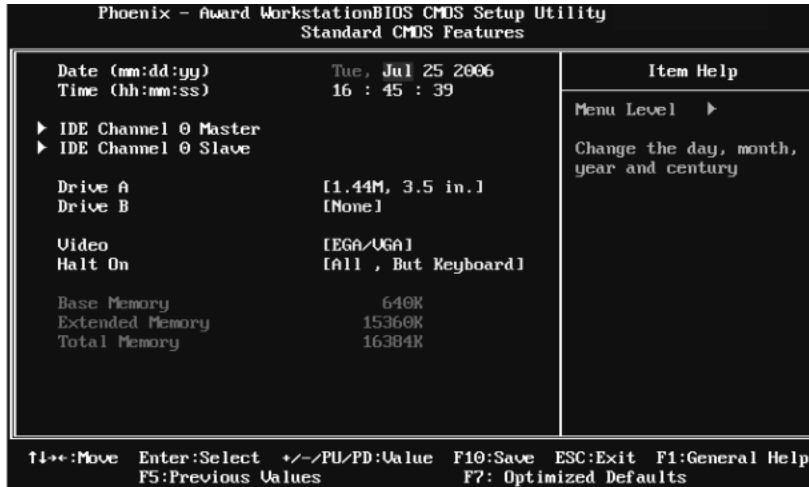

**Main Menu Selections**

This table shows the items and the available options on the Main Menu.

Item	Options	Description
Date	mm : dd : yy	Set the system date. Note that the 'Day' automatically changes when you set the date.
Time	hh : mm : ss	Set the system internal clock.
IDE Channel 0 Master	Options are in its sub menu.	Press <Enter> to enter the sub menu of detailed options
IDE Channel 0 Slave	Options are in its sub menu.	Press <Enter> to enter the sub menu of detailed options.
Drive A	360K, 5.25 in	Select the type of floppy

**NF61V Micro AM2 SE / NF61S Micro AM2 SE  
BIOS Setup**

---

---

<b>Item</b>	<b>Options</b>	<b>Description</b>
Drive B	1.2M, 5.25 in 720K, 3.5 in 1.44M, 3.5 in 2.88M, 3.5 in None	disk drive installed in your system.
Video	EGA/VGA CGA 40 CGA 80 MONO	Select the default video device.
Halt On	All Errors No Errors All, but Key board All, but Diskette All, but Disk/ Key	Select the situation in which you want the BIOS to stop the POST process and notify you.
Base Memory	N/A	Displays the amount of conventional memory detected during boot up.
Extended Memory	N/A	Displays the amount of extended memory detected during boot up.
Total Memory	N/A	Displays the total memory available in the system.

# NF61V Micro AM2 SE / NF61S Micro AM2 SE BIOS Setup

---

## 3 Advanced BIOS Features

■ Figure 3: Advanced BIOS Setup

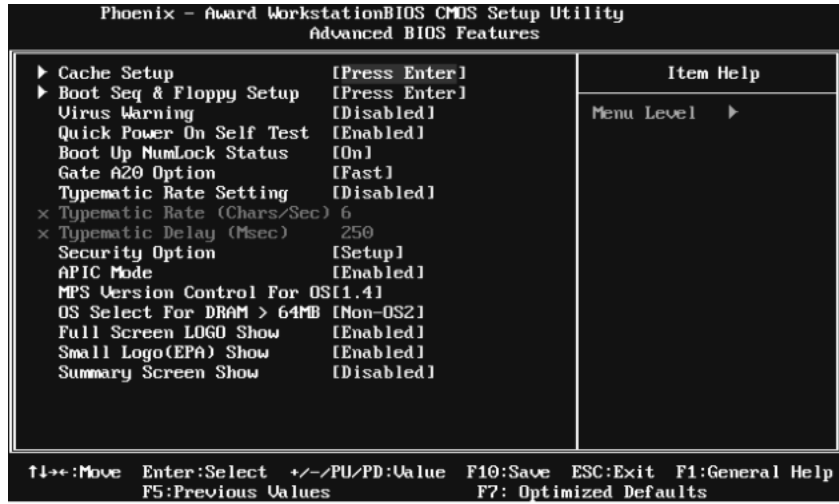

### Cache Setup





## NF61V Micro AM2 SE / NF61S Micro AM2 SE BIOS Setup

---

### CPU Internal Cache

Depending on the CPU/chipset in use, you may be able to increase memory access time with this option.

**Enabled** (default) Enable cache.

Disabled Disable cache.

### External Cache

This option enables or disables “Level 2” secondary cache on the CPU, which may improve performance.

**Enabled** (default) Enable cache.

Disabled Disable cache.

## Boot Seq & Floppy Setup

This item allows you to setup boot sequence & Floppy.



# NF61V Micro AM2 SE / NF61S Micro AM2 SE BIOS Setup

## Removable Device Priority

Select Removable Boot Device Priority.

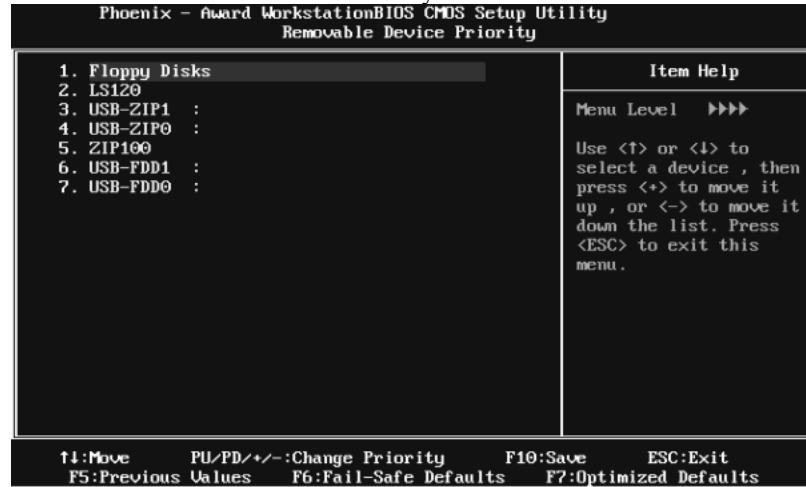

**The Choices:** Floppy Disks, Zip100, USB-FDD0, USB-FDD1, USB-ZIP0, USB-ZIP1, LS120.

## Hard Disk Boot Priority

The BIOS will attempt to arrange the Hard Disk boot sequence automatically. You can change the Hard Disk booting sequence here.

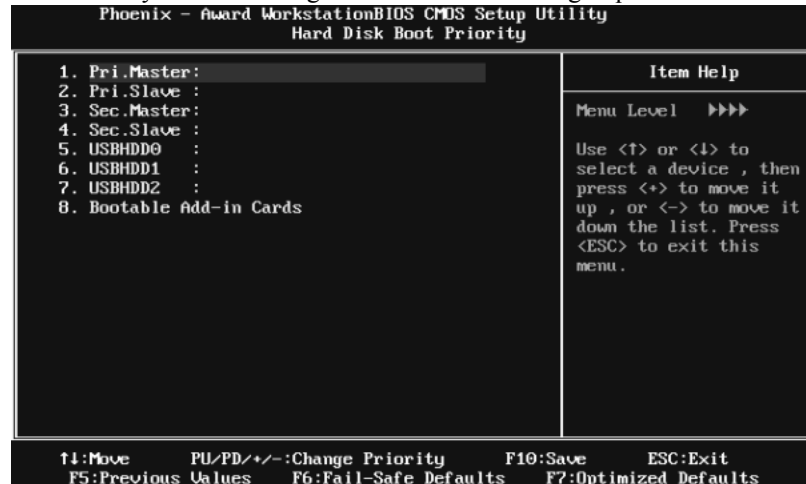

**The Choices:** Pri. Master, Pri. Slave, Sec. Master, Sec. Slave, USB HDD0, USB HDD1, USB HDD2, and Bootable Add-in Cards.

## NF61V Micro AM2 SE / NF61S Micro AM2 SE BIOS Setup

---

### CD-ROM Boot Priority

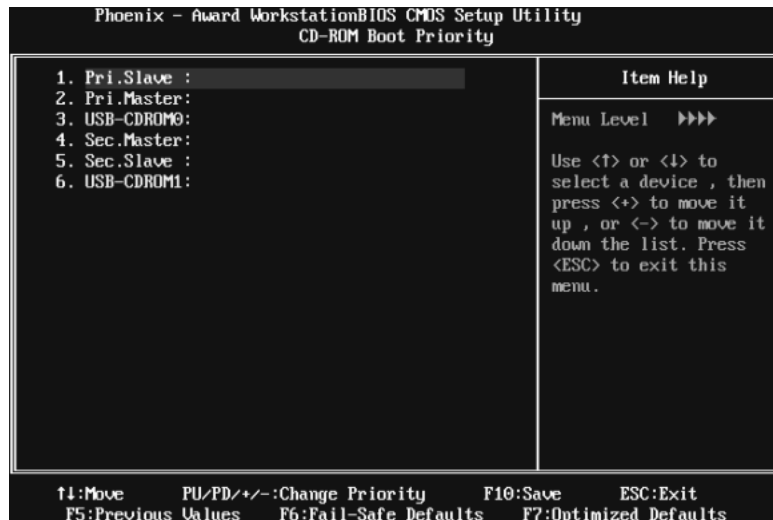

**The Choices:** Pri. Master, Pri. Slave, Sec. Master, Sec. Slave, USB-CDROM0, USB-CDROM1.

### First/Second/Third Boot Device

The BIOS will attempt to load the operating system in this order.

**The Choices:** Removable, Hard Disk, CDROM, Legacy LAN, Disabled.

### Boot Other Device

When enabled, BIOS will try to load the operating system from other device when it failed to load from the three devices above.

**The Choices:** Enabled (default), Disabled

### Swap Floppy Drive

For systems with two floppy drives, this option allows you to swap logical drive assignments.

**The Choices:** Disabled (default), Enabled.

### Boot Up Floppy Seek

When enabled, System will test the floppy drives to determine if they have 40 or 80 tracks during boot up. Disabling this option reduces the time it takes to boot-up.

**The Choices:** Enabled (default), Disabled.

## **NF61V Micro AM2 SE / NF61S Micro AM2 SE BIOS Setup**

---

### **Virus Warning**

This option allows you to choose the VIRUS Warning feature that is used to protect the IDE Hard Disk boot sector. If this function is enabled and an attempt is made to write to the boot sector, BIOS will display a warning message on the screen and sound an alarm beep.

**Disabled** (default) Virus protection is disabled.  
Enabled Virus protection is activated.

### **Quick Power On Self Test**

Enabling this option will cause an abridged version of the Power On SelfTest (POST) to execute after you power up the computer.

Disabled Normal POST.  
**Enabled** (default) Enable quick POST.

### **Boot Up NumLock Status**

Selects the NumLock State after the system switched on.

**The Choices:**

**On** (default) Numpad is number keys.  
Off Numpad is arrow keys.

### **Gate A20 Option**

Select if chipset or keyboard controller should control Gate A20.

**The Choices:**

Normal A pin in the keyboard controller controls GateA20.  
**Fast** (default) Lets chipset control Gate A20.

### **Typematic Rate Setting**

When a key is held down, the keystroke will repeat at a rate determined by the keyboard controller. When enabled, the typematic rate and typematic delay can be configured.

**The Choices:** Disabled (default), Enabled.

### **Typematic Rate (Chars/Sec)**

Sets the rate at which a keystroke is repeated when you hold the key down.

**The Choices:** 6 (default), 8, 10, 12, 15, 20, 24, 30.

### **Typematic Delay (Msec)**

Sets the delay time after the key is held down before it begins to repeat the keystroke.

**The Choices:** 250 (default), 500, 750, 1000.

## **NF61V Micro AM2 SE / NF61S Micro AM2 SE BIOS Setup**

---

### **Security Option**

This option will enable only individuals with passwords to bring the system online and/or to use the CMOS Setup Utility.

**System:** A password is required for the system to boot and is also required to access the Setup Utility.

**Setup (default):** A password is required to access the Setup Utility only. This will only apply if passwords are set from the Setup main menu.

### **APIC MODE**

Selecting Enabled enables APIC device mode reporting from the BIOS to the operating system.

**The Choices:** Enabled (default), Disabled.

### **MPS Version Control For OS**

The BIOS supports version 1.1 and 1.4 of the Intel multiprocessor specification.

Select version supported by the operation system running on this computer.

**The Choices:** 1.4 (default), 1.1.

### **OS Select For DRAM > 64MB**

A choice other than Non-OS2 is only used for OS2 systems with memory exceeding 64MB.

**The Choices:** Non-OS2 (default), OS2.

### **Full Screen Logo Show**

**The Choices:** Disabled, Enabled (default).

### **Small Logo(EPA) Show**

This item allows you to select whether the “Small Logo” shows. Enabled (default) “Small Logo” shows when system boots up. Disabled No “Small Logo” shows when system boots

**The Choices:** Enabled (default), Disabled

### **Summary Screen Show**

This item allows you to enable/disable the summary screen. Summary screen means system configuration and PCI device listing.

**The Choices:** Disabled (default), Enabled.

## NF61V Micro AM2 SE / NF61S Micro AM2 SE BIOS Setup

---

### 4 Advanced Chipset Features

This submenu allows you to configure the specific features of the chipset installed on your system. This chipset manage bus speeds and access to system memory resources, such as DRAM. It also coordinates communications with the PCI bus. The default settings that came with your system have been optimized and therefore should not be changed unless you are suspicious that the settings have been changed incorrectly.

■ **Figure 4: Advanced Chipset Setup**

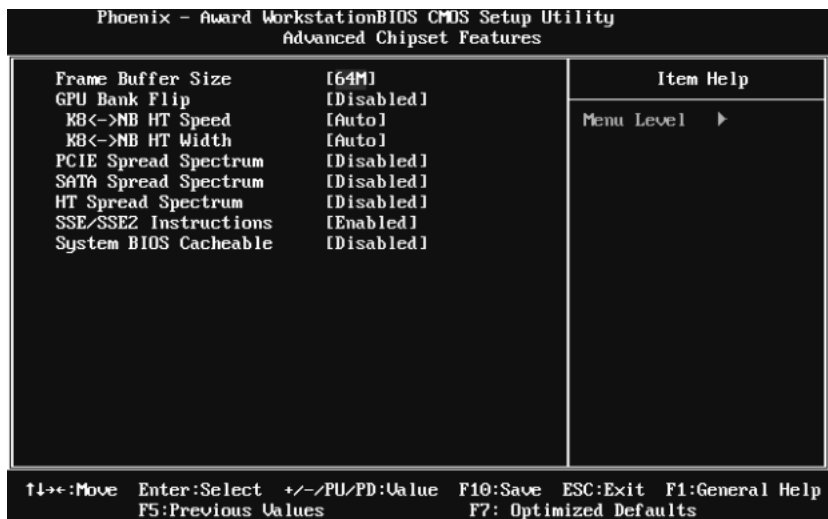

#### **Frame Buffer Size**

This item allows you to choose the frame buffer size of on-chip VGA.

**The Choices:** 64MB (default), 16MB, 32MB, 128MB, 256MB, Disabled.

#### **GPU Bank Flip**

**The Choices:** Disabled (default), Enabled.

#### **K8<->NB HT Speed**

This item allows you to select the K8<->NB HT Speed.

**The Choices:** Auto (default), 1x, 2x, 3x, 4x, 5x.

## **NF61V Micro AM2 SE / NF61S Micro AM2 SE BIOS Setup**

---

### **K8<->NB HT Width**

This item allows you to select the K8<->NB HT Width

**The Choices:** Auto (default), [ ↓ 8 ↑ 8], [ ↓ 16 ↑ 16].

### **SATA /PCIE Spread Spectrum**

This item allows you to enable/disable the Spread Spectrum function.

**The Choices:** Disabled (default), Enabled.

### **HT Spread Spectrum**

This item allows you to select HT Spread Spectrum function.

**The choices:** Disabled (default), Center, Down.

### **SSE/SSE2 instruction**

This item allows you to enable/disable SSE/SSE2 instruction.

**The Choices:** Enabled (default), Disabled.

### **System BIOS Cacheable**

Selecting the “Enabled” option allows caching of the system BIOS ROM at F0000h-FFFFFh, which is able to improve the system performance. However, any programs that attempts to write to this memory block will cause conflicts and result in system errors.

**The Choices:** Disabled (default), Enabled.

## NF61V Micro AM2 SE / NF61S Micro AM2 SE BIOS Setup

### 5 Integrated Peripherals

■ Figure 5. Integrated Peripherals

Phoenix - Award WorkstationBIOS CMOS Setup Utility		
Integrated Peripherals		
▶ IDE Function Setup	[Press Enter]	Item Help
▶ Onboard Device	[Press Enter]	
▶ Onboard IO/Address	[Press Enter]	Menu Level ▶
Onboard GPU	[Auto]	
Init Display First	[PCI-Express]	
OnChip USB	[U1.1+U2.0]	
IDE HDD Block Mode	[Enabled]	

↑↓←→:Move Enter:Select +/-/PU/PD:Value F10:Save ESC:Exit F1:General Help  
F5:Previous Values F7: Optimized Defaults

#### IDE Function Setup

Phoenix - Award WorkstationBIOS CMOS Setup Utility		
IDE Function Setup		
▶ RAID Config	[Press Enter]	Item Help
OnChip IDE Channel0	[Enabled]	
Primary Master PIO	[Auto]	Menu Level ▶▶
Primary Slave PIO	[Auto]	
Primary Master UDMA	[Auto]	
Primary Slave UDMA	[Auto]	
IDE DMA transfer access	[Enabled]	
Serial-ATA Controller	[All Enabled]	
IDE Prefetch Mode	[Enabled]	

↑↓←→:Move Enter:Select +/-/PU/PD:Value F10:Save ESC:Exit F1:General Help  
F5:Previous Values F7: Optimized Defaults



## NF61V Micro AM2 SE / NF61S Micro AM2 SE BIOS Setup

### RAID Config

Phoenix - Award Workstation BIOS CMOS Setup Utility		
RAID Config		
RAID Enable	[Disabled]	Item Help
× SATA 1 Primary	RAID Disabled	Menu Level >>>>
× SATA 1 Secondary	RAID Disabled	
× SATA 2 Primary	RAID Disabled	
× SATA 2 Secondary	RAID Disabled	

↑↓: Move    Enter: Select    +/-/PU/PD: Value    F10: Save    ESC: Exit    F1: General Help  
F5: Previous Values    F7: Optimized Defaults

#### RAID Enable

This option allows you to enable or disable RAID function.

**The Choices:** Disabled (default), Enabled.

#### SATA 1/2 Primary/Secondary RAID

This option allows you to enable or disable SATA A Primary/Secondary RAID.

**The Choices:** Disabled (default), Enabled.

#### On-chip IDE Channel 0

The motherboard chipset contains a PCI IDE interface with support for two IDE channels. Select "Enabled" to activate the first and/or second IDE interface. Select "Disabled" to deactivate an interface if you are going to install a primary and/or secondary add-in IDE interface.

**The Choices:** Enabled (default), Disabled.

#### Primary Master/Slave PIO

The IDE PIO (Programmed Input / Output) fields let you set a PIO mode (0-4) for each of the IDE devices that the onboard IDE interface supports. Modes 0 to 4 will increase performance progressively. In Auto mode, the system automatically determines the best mode for each device.

**The Choices:** Auto (default), Mode0, Mode1, Mode2, Mode3, Mode4.

## **NF61V Micro AM2 SE / NF61S Micro AM2 SE BIOS Setup**

---

### **Primary Master/Slave UDMA**

Ultra DMA function can be implemented if it is supported by the IDE hard drives in your system. As well, your operating environment requires a DMA driver (Windows 95 or OSR2 may need a third party IDE bus master driver). If your hard drive and your system software both support Ultra DMA, select Auto to enable BIOS support.

**The Choices:** **Auto** (default), Disabled.

### **IDE DMA Transfer Access**

This item allows you to enable or disable the IDE DMA transfer access.

**The Choices:** **Enabled** (default), Disabled.

### **Serial-ATA Controller**

Enables support for Serial-ATA controller.

**The Choices:** **All Enabled** (default), Disabled, SATA-1, SATA-2

### **IDE Prefetch Mode**

The “onboard” IDE drive interfaces supports IDE prefetch function for faster drive access. If the interface on your drive does not support prefetching, or if you install a primary and/or secondary add-in IDE interface, set this option to “Disabled”.

**The Choices:** **Enabled** (default), Disabled.

## NF61V Micro AM2 SE / NF61S Micro AM2 SE BIOS Setup

---

### Onboard Device

Phoenix - Award Workstation BIOS CMOS Setup Utility		Item Help
Onboard Device		
USB Memory Type	[SHADOW]	
USB Keyboard/Storage Supp	[Disabled]	
USB Mouse Support	[Disabled]	Menu Level >>
HD Audio	[Auto]	
MAC Lan	[Auto]	
MAC Media Interface	[Pin Strap]	
Onboard Lan Boot ROM	[Disabled]	

↑↓: Move Enter: Select +/-/PU/PD: Value F10: Save ESC: Exit F1: General Help  
F5: Previous Values F7: Optimized Defaults

#### USB Memory Type

The item allows you select the type of USB Memory.

**The Choices:** SHADOW (default), Base Memory (640K).

#### USB Keyboard/ Storage Support

This item allows you to support the USB legacy devices.

**The Choices:** Enabled, Disabled (default).

#### USB Mouse Support

This item allows you to enable or disable the USB Mouse Legacy Support.

**Enabled** Enable USB Mouse Support.

**Disabled** (default) Disable USB Mouse Support.

#### HD Audio

This item allows you to enable or disable to support HD Audio.

**The Choices:** Auto (default), Disabled.

## NF61V Micro AM2 SE / NF61S Micro AM2 SE BIOS Setup

---

### MAC LAN

This option allows you to control the onboard MAC LAN.

The Choices: **Auto** (default), Disabled.

### MAC Media Interface

This option allows you to control the onboard MAC Media Interface.

The Choices: **Pin Strap** (default), MII, RGMII

### Onboard LAN Boot ROM

This item allows you to enable or disable the Onboard LAN Boot ROM.

The Choices: **Disabled** (default), Enabled.

## Onboard I/O Address

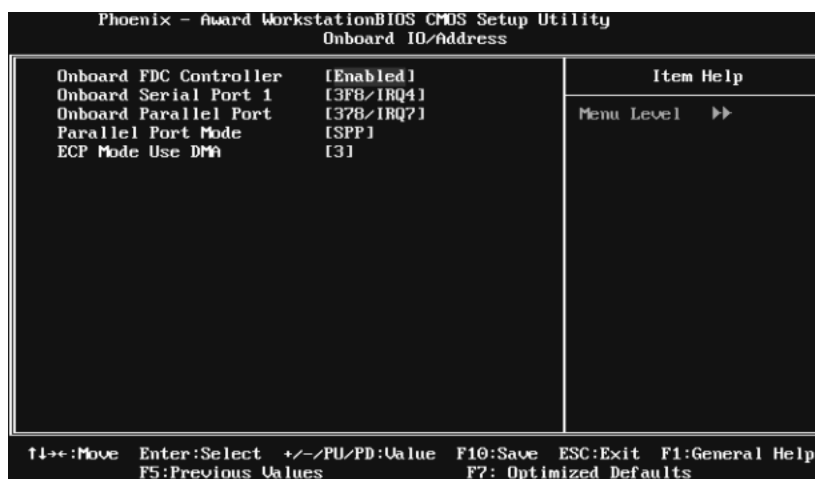

### Onboard FDC Controller

Select enabled if your system has a floppy disk controller (FDC) installed on the system board and you wish to use it. If you installed another FDC or the system uses no floppy drive, select disabled in this field.

The Choices: **Enabled** (default), Disabled.

### Onboard Serial Port 1

Select an address and corresponding interrupt for the first and second serial ports.

The Choices: **3F8/IRQ4** (default), Disabled, 2F8/IRQ3, 3E8/IRQ4, 2E8/IRQ3, Auto.

## **NF61V Micro AM2 SE / NF61S Micro AM2 SE BIOS Setup**

---

### **Onboard Parallel Port**

This item allows you to determine access onboard parallel port controller with which I/O Address.

**The Choices:** 378/IRQ 7 (default), 278/IRQ5, 3BC/IRQ7, Disabled.

### **Parallel Port Mode**

This item allows you to determine how the parallel port should function. The default value is SPP.

**The Choices:**

SPP (default)	Using Parallel port as Standard Printer Port.
EPP	Using Parallel Port as Enhanced Parallel Port.
ECP	Using Parallel port as Extended Capabilities Port.
ECP+EPP	Using Parallel port as ECP & EPP mode.

### **ECP Mode Use DMA**

Select a DMA Channel for the port.

**The Choices:** 3 (default), 1.

### **Onboard GPU**

This item allows you to control the Onboard GPU.

**The Choices:** Auto (default), Always Enable.

### **Init Display First**

With systems that have multiple video cards, this item determines whether the primary display uses a PCI Slot or an AGP Slot.

**The Choices:** PCI-Express (default), PCI Slot, Onboard.

### **OnChip USB**

This option should be enabled if your system has a USB installed on the system board. You may need to disable this feature if you add a higher performance controller.

**The Choices:** V1.1+V2.0 (default), Disabled, V1.1

### **IDE HDD Block Mode**

Block mode is also called block transfer, multiple commands, or multiple sectors read / write. If your IDE hard drive supports block mode (most new drives do), select Enabled for automatic detection of the optimal number of block mode (most new drives do), select Enabled for automatic detection of the optimal number of block read / write per sector where the drive can support.

**The Choices:** Enabled (default), Disabled.

## NF61V Micro AM2 SE / NF61S Micro AM2 SE BIOS Setup

### 6 Power Management Setup

The Power Management Setup Menu allows you to configure your system to utilize energy conservation and power up/power down features.

■ **Figure 6. Power Management Setup**

Phoenix - Award Workstation BIOS CMOS Setup Utility		Item Help
Power Management Setup		Menu Level ▶
ACPI function	[Enabled]	
ACPI Suspend Type	[S1(POS)]	
Power Management	[User Define]	
Video Off Method	[DPMS Support]	
HDD Power Down	[Disabled]	
Soft-Off by PBTN	[Instant-Off]	
WOL(PME#) From Soft-Off	[Disabled]	
WOR(RI#) From Soft-Off	[Disabled]	
USB Resume from S3/S4	[Disabled]	
Power-On by Alarm	[Disabled]	
× Day of Month Alarm	0	
× Time (hh:mm:ss) Alarm	0 : 0 : 0	
HPET Support	[Enabled]	
POWER ON Function	[BUTTON ONLY]	
KB Power ON Password	[Enter]	
Hot Key Power ON	[Ctrl-F1]	
PWRON After PWR-Fail	[Off]	

↑↓:Move Enter:Select +/-/PU/PD:Value F10:Save ESC:Exit F1:General Help  
F5:Previous Values F7: Optimized Defaults

#### ACPI Function

This item displays the status of the Advanced Configuration and Power Management (ACPI).

**The Choices:** Enabled (default), Disabled.

#### ACPI Suspend Type

The item allows you to select the suspend type under the ACPI operating system.

**The Choices:** S1 (POS) (default) Power on Suspend  
S3 (STR) Suspend to RAM  
S1 & S3 POS+STR

## **NF61V Micro AM2 SE / NF61S Micro AM2 SE BIOS Setup**

---

### **Power Management**

This category allows you to select the power saving method and is directly related to the following modes:

1. HDD Power Down.
2. Suspend Mode.

There are three options of Power Management, three of which have fixed mode settings

*Min. Power Saving*

Minimum power management.

Suspend Mode = 1 hr.

HDD Power Down = 15 min

*Max. Power Saving*

Maximum power management only available for sl CPU's.

Suspend Mode = 1 min.

HDD Power Down = 1 min.

**User Define** (default)

Allow you to set each option individually.

When you choose user define, you can adjust each of the item from 1 min. to 1 hr. except for HDD Power Down which ranges from 1 min. to 15 min.

### **Video Off Method**

This option determines the manner when the monitor goes blank.

V/H SYNC+Blank

This selection will cause the system to turn off the vertical and horizontal synchronization ports and write blanks to the video buffer.

Blank Screen

This option only writes blanks to the video buffer.

**DPMS** (default)

Initial display power management signaling.

### **HDD Power Down**

When enabled, the hard-disk drives will power down after a set time of system inactivity. All other devices remain active.

**The Choices:** Disabled (default), 1 Min, 2 Min, 3 Min, 4 Min, 5 Min, 6 Min, 7 Min, 8 Min, 9 Min, 10 Min, 11 Min, 12 Min, 13 Min, 14 Min, 15Min.

## ***NF61V Micro AM2 SE / NF61S Micro AM2 SE BIOS Setup***

---

### **Soft-Off by PWR-BTN**

This item determines the behavior of system power button. Instant off turn off the power immediately, and Delay 4 Sec. will require you to press and hold the power button for 4 seconds to cut off the system power.

**The Choices:** Delay 4 Sec, **Instant-Off** (default).

### **wOL(PME#)/ From Soft-Off**

This item allows you to enable or disable Wake On LAN from Soft-Off function.

**The Choices:** Disabled (default), Enabled.

### **wOR(RI#) From Soft-Off**

This item allows you to enable or disable Wake On Ring from Soft-Off function.

**The Choices:** Disabled (default), Enabled.

### **USB Resume from S3/S4**

This item allows you to enable or disabled the USB device wake up from S3/S4 function.

**The Choices:** Disabled (default), Enabled.

### **Power-On by Alarm**

This function is for setting date and time for your computer to boot up. When enabled, you can choose the date and time to boot up the system.

**The Choices:** Disabled (default), Enabled.

Date (of Month) Alarm

You can choose which month the system will boot up.

Time (hh:mm:ss) Alarm

You can choose the system boot up time, input hour, minute and second to specify.

Note: If you have change the setting, you must let the system boot up until it goes to the operating system, before this function will work.

### **HPET Support**

**The Choices:** Enabled (default), Disabled.



## ***NF61V Micro AM2 SE / NF61S Micro AM2 SE BIOS Setup***

---

### **POWER ON Function**

This item allows you to choose the power on method.

**The Choices:** **Button Only** (default), Password, Hot Key, Mouse Move/Click, Mouse Double Click, Any Key, Keyboard 98.

### **KB Power ON Password**

Input password and press Enter to set the Keyboard power on password.

### **Hot Key Power ON**

Choose the Hot Key combination to boot up the system.

**The Choices:** **Ctrl-F1**(default), Ctrl-F2, Ctrl-F3, Ctrl-F4, Ctrl-F5, Ctrl-F6, Ctrl-F7, Ctrl-F8, Ctrl-F9, Ctrl-F10, Ctrl-F11, and Ctrl-F12.

### **POWER After PWR-Fail**

This setting specifies how your system should behave after a power fail or interrupts occurs. By choosing off will leave the computer in the power off state. Choosing On will reboot the computer. Former-Sts will restore the system to the status before power failure or interrupt occurs.

**The Choices:** **Off** (default), On, Former-Sts.

## NF61V Micro AM2 SE / NF61S Micro AM2 SE BIOS Setup

### 7 PnP/PCI Configurations

This section describes configuring the PCI bus system. PCI, or Personal Computer Interconnect, is a system which allows I/O devices to operate at speeds nearing the speed of the CPU itself uses when communicating with its own special components. This section covers some very technical items and it is strongly recommended that only experienced users should make any changes to the default settings.

■ **Figure 7: PnP/PCI Configurations**



#### Reset Configuration Data

The system BIOS supports the PnP feature which requires the system to record which resources are assigned and protects resources from conflict.

Every peripheral device has a node, which is called ESCD. This node records which resources are assigned to it. The system needs to record and update ESCD to the memory locations. These locations are reserved in the system BIOS. If the Disabled (default) option is chosen, the system's ESCD will update only when the new configuration varies from the last one. If the Enabled option is chosen, the system is forced to update ESCDs and then is automatically set to the "Disabled" mode.

The above settings will be shown on the screen only if "Manual" is chosen for the resources controlled by function.

Legacy is the term, which signifies that a resource is assigned to the ISA Bus

## ***NF61V Micro AM2 SE / NF61S Micro AM2 SE BIOS Setup***

---

and provides non-PnP ISA add-on cards. PCI / ISA PnP signify that a resource is assigned to the PCI Bus or provides for ISA PnP add-on cards and peripherals.

**The Choices:** Disabled (default), Enabled.

### **Resources Controlled By**

By Choosing “Auto(ESCD)” (default), the system BIOS will detect the system resources and automatically assign the relative IRQ and DMA channel for each peripheral. By Choosing “Manual”, the user will need to assign IRQ & DMA for add-on cards. Be sure that there are no IRQ/DMA and I/O port conflicts.

**The Choices:** Auto (ESCD) (default), Manual.

### **IRQ Resources**

This submenu will allow you to assign each system interrupt a type, depending on the type of device using the interrupt. When you press the “Press Enter” tag, you will be directed to a submenu that will allow you to configure the system interrupts. This is only configurable when “Resources Controlled By” is set to “Manual”.

IRQ-5	assigned to PCI Device
IRQ-7	assigned to PCI Device
IRQ-9	assigned to PCI Device
IRQ-10	assigned to PCI Device
IRQ-11	assigned to PCI Device
IRQ-14	assigned to PCI Device
IRQ-15	assigned to PCI Device

### **PCI / VGA Palette Snoop**

Some old graphic controllers need to “snoop” on the VGA palette and then map it to their display as a way to provide boot information and VGA compatibility. This item allows such snooping to take place.

**The Choices:** Disabled (default), Enabled.

### **Maximum Payload Size**

Set the maximum payload size for Transaction packets (TLP).

**The Choice:** 4096 (default.), 128, 256, 512, 1024, 2048.

## NF61V Micro AM2 SE / NF61S Micro AM2 SE BIOS Setup

### 8 PC Health Status

■ Figure 8: PC Health Status



#### Shutdown Temperature

This item allows you to set up the CPU shutdown Temperature. This item is only effective under Windows 98 ACPI mode.

**The Choices:** Disabled, 70°C / 158°F (default), 65°C / 149°F, 60°C / 140°F.

#### Show H/W Monitor in POST

If your computer contains a monitoring system, it will show PC health status during POST stage. The item offers several different delay times.

**The Choices:** Enabled (default), Disabled.

#### CPU FAN Control by

Choose "smart" to reduce the noise caused by CPU FAN.

**The Choices:** Always On (default), Smart.

#### SYS FAN Control by

Choose "smart" to reduce the noise caused by the System FAN.

**The Choices:** Always On (default), Smart.

## ***NF61V Micro AM2 SE / NF61S Micro AM2 SE BIOS Setup***

---

---

### **CPU Vcore, Chipset Volt,HT/DDR Voltage, +3.3V, +5.0V, +12.0V, 5V (SB), Voltage Battery**

Detect the system's voltage status automatically.

### **CPU Temp**

This field displays the current temperature of CPU.

### **Current CPU FAN Speed**

This field displays the current speed of CPU fan.

### **Current SYS FAN Speed**

This field displays the current speed SYSTEM fan.

## NF61V Micro AM2 SE / NF61S Micro AM2 SE BIOS Setup

---

### 9 Performance Booster Zone

■ Figure 9: Performance Booster Zone



#### CPU Spec Voltage

This item allows you to select CPU Spec Voltage .

**The Choices:** Auto (default).

#### Memory Spec Voltage

This item allows you to select memory Spec Voltage .

**The Choices:** 1.950v (default).

#### NPT Vid control

This function allows you to adjust the CPU voltage.

**The Choices:** Auto (default), 0.3875V ~ 1.725V (differs from CPU)

#### Memory Voltage

This item allows you to select memory Voltage.

**The Choices:** 1.950V (default), 2.000V, 2.050V, 2.100V.

## NF61V Micro AM2 SE / NF61S Micro AM2 SE BIOS Setup

### NPT Fid control

This function allows you to adjust the frequency ratio of CPU.

**The Choices:** Auto (default), x4: 800Mhz ~ x25: 5000Mhz  
(differs from CPU)

### CPU Frequency

This item allows you to select the CPU Frequency.

**The Choices:** 200 (default), 201~450.

### PCIE Clock

**The Choices:** 100MHz (default), 101MHz ~ 150MHz

### K8<->NB HT Speed

This item allows you to select the K8<->NB HT Speed.

**The Choices:** Auto (default), 1x, 2x, 3x, 4x, 5x.

### Onboard GPU over clock

This item allows you to select the GPU over clock.

**The Choices:** 425 (default).

Min= 100

Max= 1000

Key in a DEC number.

### DRAM Configuration

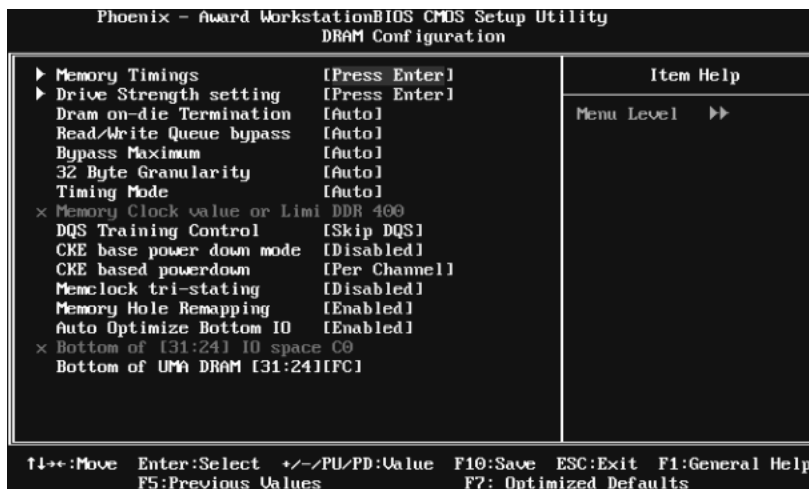







## **NF61V Micro AM2 SE / NF61S Micro AM2 SE BIOS Setup**

---

### **CS drive strength**

The Choices: **Auto** (default), 1.0x, 1.25x, 1.5x, 2.0x.

### **MA drive strength**

The Choices: **Auto** (default), 1.0x, 1.25x, 1.5x, 2.0x.

### **MCLK drive strength**

The Choices: **Auto** (default), 0.75x, 1.0x, 1.25x, 1.50x.

### **MD drive strength**

The Choices: **Auto** (default), 0.75x, 1.0x, 1.25x, 1.50x.

### **DQS drive strength**

The Choices: **Auto** (default), 0.75x, 1.0x, 1.25x, 1.50x.

### **Dram on-die Terminator**

The Choices: **Auto** (default), Disable, 75ohm, 150ohm, 50ohm.

### **Read/Write Queue bypass**

The Choices: **Auto** (default), 2 times, 4 times, 8 times, 16 times.

### **Bypass Maximum**

The Choices: **Auto** (default), No bypass, 1 time ~ 15 time.

### **32 Byte Granularity**

The Choices: **Auto** (default), 64-byte, 32-byte.

### **Timing Mode**

The Choices: **Auto** (default), MaxMemClk.

### **Memory Clock value or Limit**

The Choices: **DDR 400** (default), DDR 533, DDR 667, DDR 800.

### **DQS Training Control**

The Choices: **Skip DQS** (default), Perform DQS.

### **CKE base power down mode**

The Choices: **Disabled** (default), Enabled.

### **CKE base powerdown**

The Choices: **Per Channel** (default), Per CS.

### **Memclock tri-stating**

The Choices: **Disabled** (default), Enabled.

## **NF61V Micro AM2 SE / NF61S Micro AM2 SE BIOS Setup**

---

### **Memory Hole Remapping**

The Choices: Enabled (default), Disabled.

### **Auto Optimize Bottom IO**

The Choices: Enabled (default), Disabled.

### **Bottom of [31:24] IO space**

The Choices: Min=0000 Max=00FF; Key in a HEX number.

### **Bottom of UMA DRAM [31:24]**

The Choices: Min=0000 Max=00FC; Key in a HEX number.

### **Special Notice:**

If the system's frequency that you are selected is not functioning, there are two methods of booting-up the system.

Method 1:

Clear the COMS data by setting the JCOMS1 ((2-3) closed)) as "ON" status. All the CMOS data will be loaded as defaults setting.

Method 2:

Press the <Insert> key and Power button simultaneously, after that keep-on pressing the <Insert> key until the power-on screen showed.

This action will boot-up the system according to FSB of the processor

It's strongly recommended to set CPU Vcore and clock in default setting. If the CPU Vcore and clock are not in default setting, it may cause CPU or M/B damage.